

**ROTORA**<sup>TM</sup>  
CIRCUIT BRAKER

**2008 BRAKE GUIDE**



255/30ZR20

RD. 34

12

ROTORA  
CIRCUIT BRAKER

FOUNDED IN 1999, ROTORA IS A MAJOR AFTERMARKET MANUFACTURER OF HIGH PERFORMANCE BRAKING SYSTEMS AND COMPONENTS INCLUDING RACING CALIPERS, BRAKE DISCS, STAINLESS STEEL BRAIDED BRAKE HOSES AND PADS RANGING FROM ORIGINAL EQUIPMENT AFTERMARKET REPLACEMENT PARTS TO RACING AND HIGH PERFORMANCE UPGRADES.

PREVIOUSLY ESTABLISHED AS AN ORIGINAL EQUIPMENT MANUFACTURER OF AFTERMARKET BRAKE COMPONENTS (INCLUDING CALIPERS, BRAKE DISCS, DRUMS, AND PADS) IN THE EARLY 1980'S, ROTORA UTILIZED ITS TECHNICAL AND PRODUCTION KNOWLEDGE GAINED FROM OEM TO OFFER MOTORSPORT ENTHUSIASTS THE VERY BEST IN HIGH PERFORMANCE BRAKE UPGRADE SYSTEMS. AS RACING ENTHUSIASTS, THE FOUNDING PARTNERS OF ROTORA SHARE THE SAME PASSION AND DREAM: TO DEVELOP AN UNCOMPROMISING BRAKING SYSTEM TO MEET AND EXCEED ALL REQUIRED BRAKE PERFORMANCE SPECIFICATIONS IN THE SEVEREST CONDITIONS OF ALL MOTORSPORT FIELDS. THIS DRIVE TOWARDS HIGHER INNOVATIVE BRAKING SOLUTIONS NOT ONLY INVOLVES EXPLORING NEW MATERIALS AND NEW TECHNOLOGIES, BUT ALSO THE RESEARCH IN VEHICLE DYNAMICS TO ACHIEVE THE GREATEST BALANCE BETWEEN EFFICIENCY, STABILITY, RELIABILITY, AND CONTROLLABILITY.

THROUGH RIGOROUS RESEARCH, DESIGN, ENGINEERING, ALONG WITH EXTENSIVE ROAD AND TRACK TESTING TO PRODUCE THE MOST INNOVATIVE BRAKE SYSTEMS AVAILABLE ON AND OFF ROAD, ROTORA'S HIGH-QUALITY AND SPECIFICATIONS ARE MAINTAINED THROUGH STRICT QUALITY CONTROL INSPECTION, WHICH ASSURES THAT EVERY COMPONENT MEET WORLDWIDE ISO 9001 QUALITY AND SAFETY STANDARDS.

WITH COMPANY-OWNED PRODUCTION FOUNDRIES ACROSS THE GLOBE, ROTORA CONTROLS ALL PHASES OF DEVELOPMENT FROM CONCEPTUAL DESIGN TO FINAL FORGING PRODUCTION. ROTORA PROVES ITS BRAKING SYSTEM TECHNOLOGY WITH MULTIPLE ROAD RACE MOTORSPORT VENUES INCLUDING SCCA, N.A.S.A. AND D1 GRAND PRIX. TODAY, THE COMPANY CONTINUES TO MANUFACTURE A WIDE VARIETY OF HIGH PERFORMANCE CALIPERS, BRAKE DISCS, PADS, AND COMPLETE BRAKE UPGRADE SYSTEMS FOR THE DOMESTIC, IMPORT, EUROPEAN, AND TRUCK/SUV APPLICATIONS.

THE SUCCESS OF ROTORA COULD NOT HAVE BEEN MADE WITHOUT THE PRODUCTIVE PARTNERSHIP WITH ORGANIZATIONS FROM MANUFACTURERS TO RACE TEAMS. THESE PARTNERSHIPS PLAY A CRUCIAL ROLE IN ROTORA'S CONTINUING ADVANCEMENT.

CRAFTSMANSHIP, INNOVATION, AND PERFORMANCE: THESE ARE THE COMMITMENTS ROTORA OFFERS TO CONSUMER DEMANDS FOR THE VERY BEST IN QUALITY, SAFETY, AND PERFORMANCE PRODUCTS.

COMPANY

BRAKE SYSTEM

\_CALIPER KIT

\_BRAKE PAD

\_BRAKE DISC

\_BRAKE LINE



ACCELERATE. TURN. SHIFT. BRAKE.



ROTORA BRAKE SYSTEM

PROFILE

MADE OF FORGED BILLET ALUMINUM ALLOY AND CNC MACHINED TO ENSURE THE HIGHEST QUALITY; ROTORA'S HIGH PERFORMANCE BRAKE SYSTEM ENABLES SUPERIOR BRAKE MODULATION WHILE IMPROVING OVERALL PEDAL FEEL TO ENSURE EQUAL DISTRIBUTION OF WEIGHT TRANSFER WHEN BRAKING. TO ACHIEVE THIS PROPORTIONAL FRONT-TO-REAR BRAKE BIAS, ROTORA'S OPPOSING PISTON CALIPERS ARE FINE TUNED BY INCREASING THE CLAMP LOAD TO THE OPTIMAL LEVEL WHILE UTILIZING THE STOCK MASTER CYLINDER TO RETAIN OVERALL FRONT-TO-REAR BRAKE BIAS. ROTORA'S FULL BIG BRAKE SYSTEM DESIGN DELIVERS EXCELLENT INITIAL BITE, EXCEPTIONAL MODULATION, AND CONSISTENT PEDAL FEEL FOR STREET AND TRACK USE APPLICATIONS. ALL SYSTEMS ARE ABS COMPATIBLE AND DIRECT BOLT ON REPLACEMENT WITH MINIMAL MODIFICATIONS REQUIRED.

COMPONENTS/FEATURES:

- ROTORA FORGED BILLET ALUMINUM CALIPERS WITH SEQUENTIALLY SIZED PISTON BORE SIZES ENGINEERED TO EACH SPECIFIC VEHICLE.
- ROTORA FORGED BILLET 7075 ALUMINUM HAT WITH "FLOATING" DISC ASSEMBLY TO REDUCE HEAT RELATED STRESS AND UNSPRUNG WEIGHT.
- ROTORA ONE PIECE VENTED, OR TWO PIECE HEAT TREATED DIRECTIONAL VANE DISC SYSTEM TO IMPROVE AIRFLOW/COOLING UNDER SEVERE BRAKING. SLOTTED OR DRILLED/SLOTTED OVERSIZE DISCS UP TO 16" (405MM) TO ENSURE EQUAL HEAT DISSIPATION AND INCREASE THERMAL CAPACITY WHILE RELIEVING THE DISC AND BRAKE PAD SURFACE FREE OF EXCESS DEBRIS.
- ROTORA CERAMIC FORMULATED PADS DESIGNED FOR EXTREME STREET AND TRACK APPLICATION WITH HIGH CO-EFFICIENT OF FRICTION AND HIGH TEMPERATURE FADE RESISTANCE.
- ROTORA DOT COMPLIANT STAINLESS STEEL BRAIDED BRAKE LINES TO IMPROVE STIFFER PEDAL FEEL AND PREVENT BRAKE HOSE EXPANSION.
- ROTORA FORGED BILLET 7075 ALUMINUM OR CARBON STEEL (S45C) MOUNTING BRACKETS DESIGNED FOR MAXIMUM STRENGTH & WEIGHT SAVING.

OPTIONAL:

- STANDARD CALIPER COLOR: RED OR METALLIC BLUE.
- CUSTOM CALIPER COLOR: BLACK, CHROME, DARK BLUE, GOLD, GUNMETAL, ORANGE, SILVER, OR YELLOW (LEAD TIME OF 60 DAYS DEPENDING ON APPLICATION).
- CERAMIC PADS: ROTORA OFFERS A WIDE RANGE OF CERAMIC COMPOUND PAD GRADES. REFER TO BRAKE PADS SECTION TO ASSIST IN SELECTION.
- DISC TYPE: SLOTTED OR DRILLED/SLOTTED (FOR MORE SEVERE APPLICATIONS, SLOTTED IS PREFERRED. FOR STREET AND LIGHT TRACK USE, DRILLED/SLOTTED IS ACCEPTABLE).

2-PISTON (FC2):

2-PISTON CALIPER ■ 1 OR 2-PIECE DISC SYSTEM (SLOTTED OR DRILLED/SLOTTED): 290MM, OR 330MM ■ H2 CERAMIC PADS (HIGHER PAD GRADES OPTIONAL) ■ BILLET MOUNTING BRACKET (DEPENDING ON APPLICATION) ■ STAINLESS STEEL BRAKELINES & HARDWARE



4-PISTON (FC4):

4-PISTON CALIPER ■ 1 OR 2-PIECE DISC SYSTEM (SLOTTED OR DRILLED/SLOTTED): 330MM, OR 355MM ■ H2 CERAMIC PADS (HIGHER PAD GRADES OPTIONAL) ■ BILLET MOUNTING BRACKET (DEPENDING ON APPLICATION) ■ STAINLESS STEEL BRAKELINES & HARDWARE



4-PISTON (FF4):

4-PISTON CALIPER ■ 2-PIECE DISC SYSTEM (SLOTTED OR DRILLED/SLOTTED): 330MM, 355MM, OR 380MM ■ H2 CERAMIC PADS (HIGHER PAD GRADES OPTIONAL) ■ BILLET MOUNTING BRACKET ■ STAINLESS STEEL BRAKELINES & HARDWARE



- COMPANY
- PAKE SYSTEM
- CALIPER KIT
- BRAKE PAD
- BRAKE DISC
- BRAKE LINE



VOLVO RACING

REVERA®



PERFORMANCE:  
OPTIMIZING FRICTION.

\_COMPANY

BRAKE SYSTEM

\_CALIPER KIT

\_BRAKE PAD

\_BRAKE DISC

\_BRAKE LINE

**6-PISTON (FM6):**

**COMPONENTS**

6-PISTON CALIPER ■ 2-PIECE DISC SYSTEM (SLOTTED OR DRILLED/SLOTTED): 257MM ■ H2 CERAMIC PADS (HIGHER PAD GRADES OPTIONAL) ■ BILLET MOUNTING BRACKET ■ STAINLESS STEEL BRAKELINES & HARDWARE

NOTE: IMAGE SHOWN MAY NOT BE FOR YOUR SPECIFIC VEHICLE.

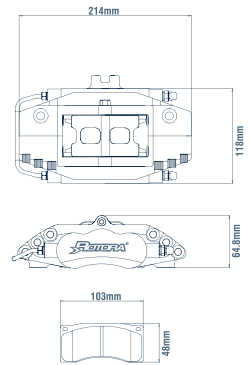

**6-PISTON (FC6):**

**COMPONENTS**

6-PISTON CALIPER ■ 2-PIECE DISC SYSTEM (SLOTTED OR DRILLED/SLOTTED): 330MM, OR 355MM ■ H2 CERAMIC PADS (HIGHER PAD GRADES OPTIONAL) ■ BILLET MOUNTING BRACKET ■ STAINLESS STEEL BRAKELINES & HARDWARE

NOTE: IMAGE SHOWN MAY NOT BE FOR YOUR SPECIFIC VEHICLE.

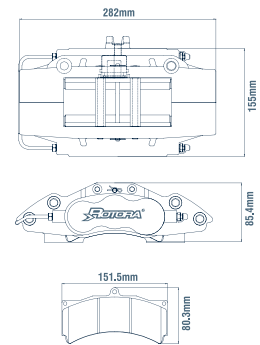

**8-PISTON (FC8):**

**COMPONENTS**

8-PISTON CALIPER ■ 2-PIECE DISC SYSTEM (SLOTTED OR DRILLED/SLOTTED): 380MM, OR 405MM ■ H2 CERAMIC PADS (HIGHER PAD GRADES OPTIONAL) ■ BILLET MOUNTING BRACKET ■ STAINLESS STEEL BRAKELINES & HARDWARE

NOTE: IMAGE SHOWN MAY NOT BE FOR YOUR SPECIFIC VEHICLE.

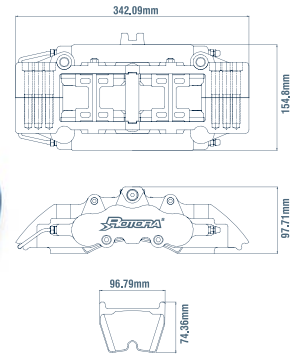

**12-PISTON (F12):**

**COMPONENTS**

12-PISTON CALIPER ■ 2-PIECE DISC SYSTEM (SLOTTED OR DRILLED/SLOTTED): 380MM, OR 405MM ■ H2 CERAMIC PADS (HIGHER PAD GRADES OPTIONAL) ■ BILLET MOUNTING BRACKET ■ STAINLESS STEEL BRAKELINES & HARDWARE

NOTE: IMAGE SHOWN MAY NOT BE FOR YOUR SPECIFIC VEHICLE.

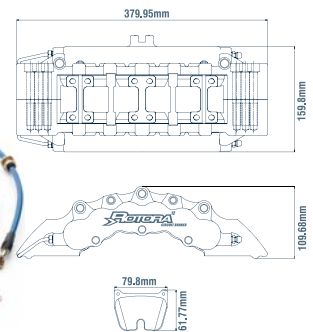



...A BRAKE SYSTEM  
WORTHY OF ITS SIZE

ROTORA CALIPER KIT OFFERS A COST EFFECTIVE SOLUTION TO MAXIMIZE BRAKING PERFORMANCE BY UTILIZING THE VEHICLE'S ORIGINAL BRAKE DISC. DESIGNED TO FIT UNDER STOCK SIZED DIAMETER WHEELS, ROTORA'S CALIPER KIT DELIVERS SUPERB BRAKING POWER AND EXCEPTIONAL MODULATION AND APPEARANCE. ROTORA CALIPER SYSTEM UTILIZES THE STOCK MASTER CYLINDER TO RETAIN OVERALL FRONT-TO-REAR BRAKE BIAS. ALL SYSTEMS ARE ABS COMPATIBLE AND DIRECT BOLT ON REPLACEMENT WITH VERY MINIMAL MODIFICATIONS REQUIRED.

**COMPONENTS/FEATURES:**

- ROTORA FORGED BILLET ALUMINUM CALIPERS WITH SEQUENTIALLY SIZED PISTON BORE SIZES ENGINEERED TO EACH SPECIFIC VEHICLE.
- ROTORA CERAMIC FORMULATED PADS DESIGNED FOR EXTREME STREET AND TRACK APPLICATION WITH HIGH CO-EFFICIENT OF FRICTION AND HIGH TEMPERATURE FADE RESISTANCE.
- ROTORA DOT COMPLIANT STAINLESS STEEL BRAIDED BRAKE LINES TO IMPROVE STIFFER PEDAL FEEL AND PREVENT BRAKE HOSE EXPANSION.
- ROTORA BILLET ALUMINUM OR STEEL MOUNTING BRACKETS DESIGNED FOR MAXIMUM STRENGTH OR WEIGHT SAVING.

**OPTIONAL:**

- **STANDARD CALIPER COLOR:** RED OR METALLIC BLUE.
- **CUSTOM CALIPER COLOR:** BLACK, CHROME, DARK BLUE, GOLD, GUNMETAL, ORANGE, SILVER, OR YELLOW (LEAD TIME OF 60 DAYS DEPENDING ON APPLICATION).
- **CERAMIC PADS:** ROTORA OFFERS A WIDE RANGE OF CERAMIC COMPOUND PAD GRADES. REFER TO BRAKE PADS SECTION TO ASSIST IN SELECTION.
- **DISC TYPE:** BASIC OEM, SLOTTED OR DRILLED/SLOTTED (FOR MORE SEVERE APPLICATIONS, SLOTTED IS PREFERRED. FOR STREET AND LIGHT TRACK USE, BASIC OEM DRILLED/SLOTTED IS ACCEPTABLE).

**4-PISTON (FM4):**

- 4-PISTON CALIPER ■ H2 CERAMIC PADS (HIGHER PAD GRADES OPTIONAL) ■ BILLET MOUNTING BRACKET (DEPENDING ON APPLICATION) ■ STAINLESS STEEL BRAKELINES & HARDWARE ■ OPTIONAL: (BASIC OEM, SLOTTED, DRILLED/SLOTTED BRAKE DISC)

**COMPONENTS**

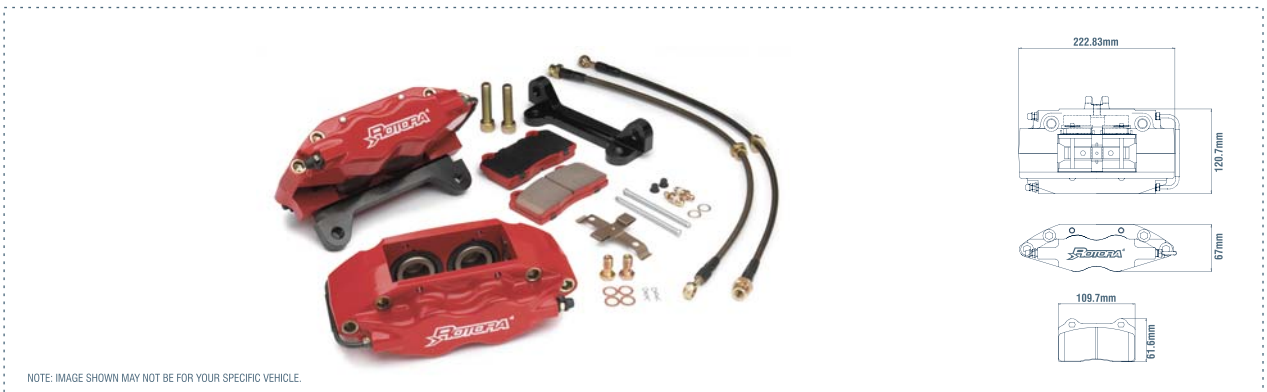

**4-PISTON (FC4):**

- 4-PISTON CALIPER ■ H2 CERAMIC PADS (HIGHER PAD GRADES OPTIONAL) ■ BILLET MOUNTING BRACKET (DEPENDING ON APPLICATION) ■ STAINLESS STEEL BRAKELINES & HARDWARE ■ OPTIONAL: (BASIC OEM, SLOTTED, DRILLED/SLOTTED BRAKE DISC)

**COMPONENTS**



**4-PISTON (FF4):**

- 4-PISTON CALIPER ■ H2 CERAMIC PADS (HIGHER PAD GRADES OPTIONAL) ■ BILLET MOUNTING BRACKET (DEPENDING ON APPLICATION) ■ STAINLESS STEEL BRAKELINES & HARDWARE ■ OPTIONAL: (BASIC OEM, SLOTTED, DRILLED/SLOTTED BRAKE DISC)

**COMPONENTS**





PERFECT BALANCE  
OF PERFORMANCE.



ROTORA CERAMIC BRAKE PADS ARE THE LATEST HIGH PERFORMANCE STREET AND RACE PADS TO BE INTRODUCED. ROTORA HAS APPLIED THE SAME MATERIALS, ENGINEERING, AND QUALITY STANDARDS FROM THE FORMULATION USED IN ITS HIGH PERFORMANCE BRAKE SYSTEMS TO OEM VEHICLES WITH STOCK CALIPERS. DESIGNED FOR EXTREME STREET OR TRACK AND HARD BRAKING APPLICATIONS, ROTORA PADS FEATURE CERAMIC-METALLIC STRENGTHENED NON-ASBESTOS FORMULA WITH A HIGH CO-EFFICIENT OF FRICTION AND HIGH TEMPERATURE FADE RESISTANCE WITH QUICK RECOVERY TO OFFER MORE CONSISTENT PEDAL FEEL FOR DRIVER CONFIDENCE. ROTORA IS CONSTANTLY DEVELOPING AND REFINING NEW CERAMIC BRAKE PAD COMPOUNDS AND NEW VARIATIONS WILL OFFER NOTHING BUT THE VERY BEST IN ALL ASPECTS OF BRAKE CONTROLLABILITY AND RELIABILITY.

ROTORA: 2008 BRAKE GUIDE - CIRCUIT BRAKER

CHARACTERISTICS:

EFFICIENCY TEST

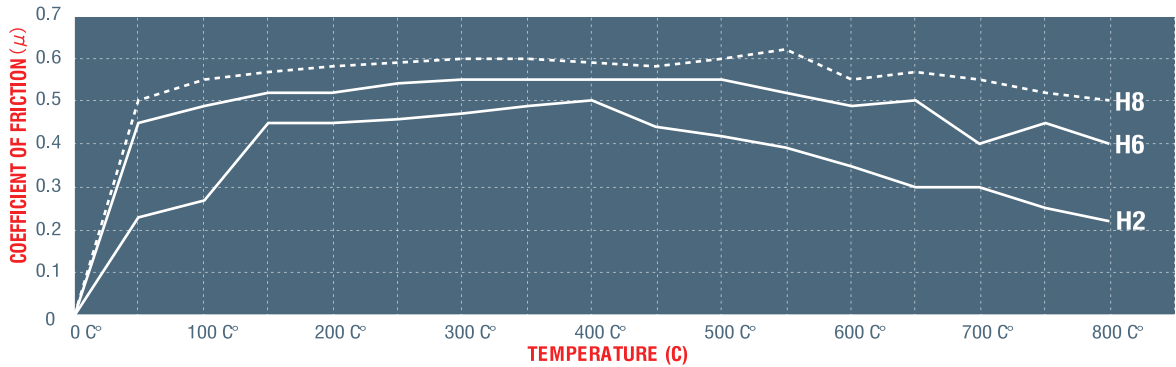

PAD TYPE: H2

PAD TYPE: H6

PAD TYPE: H8

COMPOUND: CERAMIC    DRIVE TYPE: STREET/LIGHT TRACK  
 DISC TEMPERATURE RANGE: 0-500 C/0-932 F    AVERAGE COEFFICIENT OF FRICTION: .25-.5

COMPOUND: HIGH-CERAMIC    DRIVE TYPE: TRACK/RACE  
 DISC TEMPERATURE RANGE: 200-660 C/392-1220 F    AVERAGE COEFFICIENT OF FRICTION: .44-.55

COMPOUND: CERAMIC METALLIC    DRIVE TYPE: RACE/ENDURANCE  
 DISC TEMPERATURE RANGE: -800 C/572-1472 F    AVERAGE COEFFICIENT OF FRICTION: .5-.62

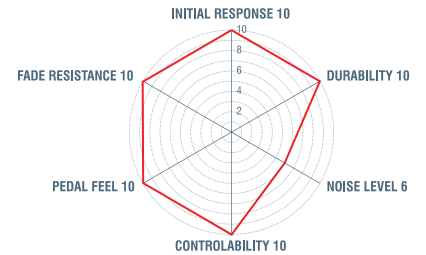
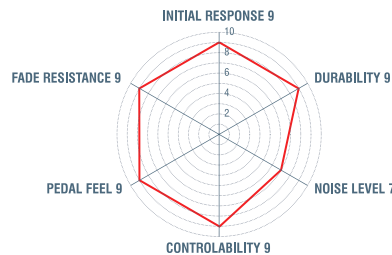
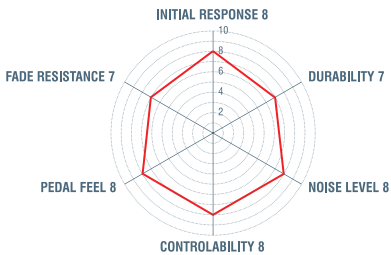

H2 HIGH-CERAMIC PAD OFFERS A SOLID BRAKE FADE RESISTANCE TO INCREASE DRIVER'S CONTROLLABILITY. WHETHER WEEKEND LIGHT TRACK, DRIFTING, OR DAILY DRIVING, ROTORA'S CERAMIC FORMULATED H2 PADS ACCOMMODATE ALL DRIVING STYLES, TRACK LENGTHS AND ENVIRONMENTAL CONDITIONS. THE IDEAL PAD FOR ALL-AROUND PERFORMANCE, DAILY STREET, AND TRACK RACEY.

CONTAINING A HIGHER CERAMIC STRENGTHENED FORMULATION, THE H6 HIGH-CERAMIC PAD DELIVERS EXCELLENT INITIAL BITE AND BRAKING FORCE UNDER HIGH BRAKE DISC TEMPERATURES. RECOMMENDED FOR TRACK USE, H6 HIGH-CERAMIC ACHIEVES CONSISTENT BRAKE PEDAL FEEL WHILE MAINTAINING STABLE CO-EFFICIENT OF FRICTION. THE IDEAL PAD FOR WINDING/TRACK.

TOP OF ROTORA'S CERAMIC PAD RANGE IS THE H8 CERAMIC METALLIC, THE ROAD RACE-SPEC UPGRADE OFFERING TREMENDOUS FADE RESISTANCE AND THERMAL STABILITY UNDER HIGH BRAKE DISC TEMPERATURES. RECOMMENDED FOR SERIOUS RACING, H8 HIGH-CERAMIC METALLIC PADS PRODUCE HIGH COEFFICIENT OF FRICTION THEREBY PROVIDING ULTIMATE STOPPING POWER AND EXCELLENT PEDAL FEEL RESPONSE FROM THE VERY START. WITH STRONG INITIAL BITE AND CONSISTENT MU LEVEL, THIS IS THE IDEAL PAD FOR ROAD RACING/ENDURANCE/HIGH CIRCUIT.

- COMPANY
- BRAKE SYSTEM
- CALIPER KIT
- BRAKE PAD
- BRAKE DISC
- BRAKE LINE



OPTIMIZED FORMULATIONS.

## ROTORA BRAKE DISC

PROFILE

DEVELOPED WITH THE SAME PARAMETERS AS THE ORIGINAL EQUIPMENT (OE) SPECIFICATIONS IN BOTH QUALITY AND FINISH, ROTORA'S DIRECT REPLACEMENT BRAKE DISCS ARE ASSURED TO MEET AND EXCEED ALL VEHICLE MANUFACTURERS' SPECIFICATIONS AND TOLERANCES UNDER THE WORLDWIDE ISO 9001 QUALITY STANDARDS. CNC MACHINED AND BALANCED FOR OPTIMUM PERFORMANCE, ROTORA'S BRAKE DISCS FEATURE SPECIAL SEGMENTED SLOT, OR DRILL/SLOT PATTERN TO ENSURE MAXIMUM HEAT AND GAS DISSIPATION FOR GREATER STOPPING POWER AND MINIMIZE WARPING AND CRACKING CAUSED BY REPEATED, HIGH STRESS, HIGH TEMPERATURE BRAKING. WITH AN "E-COAT" (BLACK) PLATING FINISH AS AN ADDED PROTECTIVE LAYER TO REDUCE CORROSION AND PROLONG DISC LIFE, ROTORA'S BRAKE DISC QUALITY GUARANTEES TOP PERFORMANCE AND LONGER DURABILITY.

## FEATURES:

- MILL BALANCED TO ELIMINATE DISC VIBRATIONS.
- UNIFORM THICKNESS AND FINISH OF BRAKING SURFACE TO ENSURE IMPROVED PAD TO DISC FITMENT.
- PRECISE TOLERANCE TO ENSURE TRUE RUN-OUT.



NOTE: IMAGE SHOWN MAY NOT BE FOR YOUR SPECIFIC VEHICLE.

## BASIC OEM DISC:

- DEVELOPED WITH THE SAME PARAMETERS AS THE ORIGINAL EQUIPMENT IN BOTH QUALITY AND FINISH.
- FOR DAILY DRIVING, BASIC OEM DISC IS PREFERRED.

## SLOTTED DISC:

- SEGMENTED SLOT PATTERN FOR IMPROVED PAD GRIP AND PEDAL FEEL.
- CLEANS AWAY DEBRIS BETWEEN PAD AND DISC.
- MINIMIZE WARPAGE AND BRAKE FADE RESISTANCE.
- ENSURES MAXIMUM HEAT AND GAS DISSIPATION.
- FOR MORE SEVERE APPLICATIONS (INCLUDING SUVs), SLOTTED IS PREFERRED.

## DRILLED &amp; SLOTTED DISC:

- SEGMENTED RADIUS DRILL & SLOT PATTERN FOR IMPROVED PAD GRIP AND REDUCE NOISE.
- CLEANS AWAY DEBRIS BETWEEN PAD AND DISC.
- ENSURES HEAT AND GAS DISSIPATION.
- FOR STREET AND LIGHT TRACK USE, DRILLED & SLOTTED IS PREFERRED.

## ROTORA STAINLESS STEEL BRAKELINES

PROFILE

ROTORA STAINLESS STEEL BRAIDED BRAKE LINES PREVENT BRAKE HOSE EXPANSION UNDER PRESSURE AND IMPROVE STIFFER PEDAL FEEL. ALL ROTORA'S STEEL BRAIDED LINES MEET D.O.T. COMPLIANCE STANDARDS AND PRESSURE TESTED TO MEET FMVSS-106 (FEDERAL MOTOR VEHICLE SAFETY STANDARDS) STANDARD. ALL KITS INCLUDE FITTINGS, HOSES AND ALL NECESSARY HARDWARE.



NOTE: IMAGE SHOWN MAY NOT BE FOR YOUR SPECIFIC VEHICLE.

\_COMPANY

\_BRAKE SYSTEM

\_CALIPER KIT

\_BRAKE PAD

\_BRAKE DISC

\_BRAKE LINE



Lowenhardt

FORM FOLLOWS FUNCTION.

ROTORA: 2008 BRAKE GUIDE \_ CIRCUIT BRAKER

\_COMPANY

BRAKE SYSTEM

\_CALIPER KIT

\_BRAKE PAD

\_BRAKE DISC

\_BRAKE LINE





CONFIDENCE IS GOOD. CONTROL IS BETTER.

## TERMS & CONDITIONS

### FREIGHT/SHIPPING:

PRICES DO NOT INCLUDE FREIGHT/SHIPPING CHARGES. ALL PRODUCTS ARE SHIPPED BY GROUND WITHIN THE UNITED STATES (EXCLUDING ALASKA AND HAWAII) UNLESS OTHER ARRANGEMENTS ARE MADE. INTERNATIONAL WORLDWIDE SHIPPING IS AVAILABLE; PLEASE CONTACT A ROTORA SALES REPRESENTATIVE FOR FURTHER ASSISTANCE.

### FREIGHT DAMAGE:

CUSTOMER MUST MAKE ANY AND ALL DAMAGE CLAIMS WITH THE RESPONSIBLE CARRIER, PREFERABLY AT THE TIME OF DELIVERY. ROTORA WILL THEN HANDLE THE CLAIM THROUGH THE CARRIER.

### PRICING:

ALL PRICES AND DISCOUNTS ARE SUBJECT TO CHANGE WITHOUT NOTICE. PLEASE VERIFY PRICES AND AVAILABILITY PRIOR TO ORDERING. BY PLACING AN ORDER YOU AGREE TO BE BOUND BY THESE TERMS AND CONDITIONS.

### BACK ORDERED & DROP SHIPPED PARTS:

WE MAKE EVERY EFFORT TO HAVE ALL PARTS AVAILABLE FOR IMMEDIATE SHIPMENT. IN THE EVENT THAT PART OF YOUR ORDER IS ON BACK ORDER, WE WILL SHIP THE AVAILABLE PARTS AND MARK THE "BACK ORDER" COLUMN OF THE INVOICE TO DESIGNATE THOSE PART(S) THAT ARE ON BACK ORDER. YOU WILL ALSO BE NOTIFIED BY PHONE OR E-MAIL IF ANY ITEMS ARE ON BACK ORDER AND BE GIVEN THE ESTIMATED DELIVERY TIME.

### SPECIAL ORDERS:

ROTORA WILL TAKE SPECIAL ORDERS. ALL SPECIAL ORDERS AND SPECIALLY PRICED MERCHANDISE MUST BE PAID FOR IN FULL AT THE TIME OF ORDER. ONCE ORDER HAS BEEN PLACED, IT IS NON-CANCELABLE. NO CANCELLATIONS, REFUNDS, OR EXCHANGES ON SPECIAL ORDER ITEMS OR CUSTOM ORDER ITEMS WILL BE ALLOWED. PARTS NOT IN STOCK, ALTHOUGH LISTED IN THIS WEB SITE, CATALOG, OR PRICE SHEET, CAN AT THE OPTION OF ROTORA BE CONSIDERED SPECIAL ORDER.

### WHEEL TO CALIPER CLEARANCE:

ROTORA'S CALIPERS AND/OR OVERSIZE DISCS ARE IN MOST CASES BIGGER THAN THE ORIGINAL CALIPERS AND/OR BRAKE DISCS. IT IS THE RESPONSIBILITY OF THE CUSTOMER TO DETERMINE THE FINAL FITMENT OF THE WHEEL TO THE ROTORA BRAKE SYSTEM. REFER TO THE WHEEL FITMENT CHART OR CONTACT ROTORA'S TECHNICAL SUPPORT TO CONFIRM IF A PARTICULAR WHEEL WILL FIT.

### BRAKE VIBRATION:

THE MOST COMMON CAUSE OF BRAKE VIBRATION IS IMPROPER BEDDING OF THE BRAKE SYSTEM/COMPONENTS. UNDER THE MOST EXTREME CONDITIONS, ANY BRAKE DISC MAY DISTORT, BUT UNEVEN PAD DEPOSITION IS A MORE TYPICAL CAUSE OF VIBRATION. IF THE SYSTEM IS NOT PROPERLY BEDDED-IN, UNEVEN PAD DEPOSITS WILL OCCUR CAUSING AN EVER-WORSENING VIBRATION. FAILURE TO IMMEDIATELY ADDRESS A PAD DEPOSITION/VIBRATION ISSUE MAY LEAD TO PERMANENT DAMAGE TO THE BRAKE DISCS. PLEASE READ AND UNDERSTAND THE BED-IN PROCEDURES INCLUDED WITH EACH INSTALLATION MANUAL. IF YOU HAVE ANY QUESTIONS, PLEASE CONTACT ROTORA TECHNICAL SUPPORT FOR FURTHER ASSISTANCE. ROTORA IS NOT LIABLE FOR VIBRATIONS CAUSED BY EXTREME USAGE OR IMPROPER BED-IN PROCEDURES.

### BRAKE NOISE:

DUE TO THE NATURE OF RACE PAD COMPOUNDS, PERFORMANCE PADS ARE MORE PRONE TO BRAKE NOISE AND SQUEAL. PROPER ANTI-SQUEAL SHIM PLATES BETWEEN THE CALIPER PISTONS AND BACKING PLATE OF THE PAD HELP REDUCE THE PROBLEM. ANTI-SQUEAL LUBRICANTS ARE ALSO AVAILABLE TO REDUCE NOISE AND SQUEAL. THE CUSTOMER IS RESPONSIBLE FOR ANY SQUEAL RELATED PROBLEMS DUE TO PAD SELECTION.

### RETURN POLICY:

RETURN FOR EXCHANGE OR REFUND WILL BE ALLOWED ONLY WITHIN 30 CALENDAR DAYS FROM THE DATE OF RECEIPT. ALL AUTHORIZED RETURN MERCHANDISE MUST BE UNUSED AND IN ITS ORIGINAL SALEABLE PACKAGING. NO RETURN OR EXCHANGE ON MERCHANDISE THAT SHOWS SIGNS OF HAVING BEEN INSTALLED, MOUNTED, SCRATCHED, OR DEFACED WILL BE ALLOWED. AN RMA NUMBER (RETURNED MATERIALS AUTHORIZATION) MUST BE ISSUED BEFORE ANY RETURNS CAN BE MADE. WE WILL NOT ACCEPT ANY RETURNS WITHOUT THIS NUMBER. PLEASE WRITE THIS NUMBER CLEARLY ON THE OUTSIDE OF THE RETURNING PACKAGE AND TAG THE ITEM(S) INSIDE WITH YOUR NAME AND RMA NUMBER. ALL RETURNS MUST BE RECEIVED BY ROTORA WITHIN 10 CALENDAR DAYS AFTER THE R.A. NUMBER HAS BEEN ISSUED. THE RMA NUMBER DOES NOT IMPLY A REPLACEMENT OR REFUND, BUT ONLY THAT WE WILL INSPECT THE MERCHANDISE BASED ON YOUR CLAIM. RETURNS MUST BE SENT FREIGHT PREPAID AND INSURED BY YOU. ORIGINAL SHIPPING AND HANDLING CHARGES ARE NOT REFUNDABLE. A PHOTO COPY OF YOUR INVOICE SHOWING THE INVOICE NUMBER MUST ACCOMPANY YOUR RETURN ALONG WITH A WRITTEN EXPLANATION AND A CONTACT PHONE NUMBER WHERE WE MAY BE ABLE TO REACH YOU. IT IS THE RESPONSIBILITY OF THE CUSTOMER/INSTALLER TO VERIFY THE CORRECTNESS OF SIZE AND APPLICATION OF THE PARTS BEFORE INSTALLATION. ROTORA WILL ONLY ISSUE CREDIT FOR MERCHANDISE RETURNED. A 20% RESTOCKING FEE WILL BE ASSESSED ON ALL AUTHORIZED RETURNS. NO CANCELLATIONS, REFUNDS, OR EXCHANGES ON SPECIAL ORDER ITEMS OR CUSTOM ORDER ITEMS WILL BE ALLOWED.

### SHIPPING ERRORS:

IF YOU RECEIVE AN INCORRECT ITEM DUE TO OUR ERROR, WE WILL ISSUE A CARRIER'S CALL TAG TO PICK UP THE INCORRECT ITEM(S) AND SHIP THE CORRECT ITEM(S) AT NO ADDITIONAL CHARGE TO YOU.

### CHANGES TO TERMS AND CONDITIONS:

ROTORA RESERVES THE RIGHT TO CHANGE THESE TERMS AND CONDITIONS AT ANY TIME WITHOUT PRIOR NOTICE, AND PURCHASER'S CONTINUED PURCHASE OF PARTS CONSTITUTES ACCEPTANCE OF THOSE CHANGES.

## DISCLAIMER OF WARRANTY & LIMITATION OF LIABILITY

ROTORA WARRANTS TO THE PURCHASER OF THIS PRODUCT, THAT IT IS FREE FROM DEFECTS IN WORKMANSHIP AND MATERIALS AT THE TIME OF PURCHASE. THIS PRODUCT WHEN PROPERLY INSTALLED IN THE TYPE OF VEHICLE PRESCRIBED, IN WHICH A DEFECT IN WORKMANSHIP AND MATERIAL SHALL BE FOUND, WILL BE EXCHANGED FREE OF CHARGE, IF RETURNED TO THE SELLER, WHO IS AUTHORIZED TO GIVE THIS WARRANTY. DUE TO THE EXTREME NATURE OF PERFORMANCE ROTORA BRAKE SYSTEMS AND COMPONENTS MAY ENCOUNTER, ROTORA CAN NOT EXTEND THIS WARRANTY BEYOND 2 WEEKS OR 500 MILES (THE RECOMMENDED BREAK IN DISTANCE) FROM TIME OF INSTALLATION. ROTORA IS NOT RESPONSIBLE FOR ITS PRODUCTS WHEN SUBJECTED IN MISUSE, ABUSE, IMPROPER APPLICATION, IMPROPER INSTALLATION, ACCIDENT, OR NORMAL WEAR.

ALL ROTORA BRAKE SYSTEMS AND BRAKE COMPONENTS ARE FOR STREET AND RECREATIONAL OFF ROAD USE ONLY. THEY ARE NOT APPROVED FOR OFF ROAD RACING, OR COMPETITION DRIVING.

THIS WARRANTY DOES NOT COVER, AND ROTORA WILL NOT PAY FOR, OR PROVIDE, LABOR OR MATERIALS WHICH MAY BE NECESSARY TO REMOVE A PRODUCT OR INSTALL A REPLACEMENT PRODUCT. THIS WARRANTY IS LIMITED TO EXCHANGE OF THE PRODUCT ONLY, WHEN RETURNED WITH ORIGINAL PURCHASE RECEIPT.

ROTORA'S LIABILITY HEREUNDER DOES NOT INCLUDE LABOR CHARGES OR INCIDENTAL OR CONSEQUENTIAL DAMAGES, NO OTHER WARRANTY IS HEREBY GIVEN, OBLIGATION UNDER THIS WARRANTY, AND OTHER EXPRESSED OR IMPLIED WARRANTIES PROVIDED UNDER STATE LAW, INCLUDING, BUT NOT NECESSARILY LIMITED TO, THE IMPLIED WARRANTIES OF MECHANIC ABILITY AND FITNESS FOR A PARTICULAR PURPOSE SHALL EXPIRE 2 WEEKS OR 500 MILES FROM DATE OF INSTALLATION.

NO PERSON IS AUTHORIZED BY ROTORA TO MODIFY OR ADD TO THE FOREGOING WARRANTY.



## ABBREVIATION & SYMBOL

"	INCH
#	NUMBER
A/T	AUTOMATIC TRANSMISSION
ABS	ANTI-LOCK BRAKE SYSTEM
AWD	ALL WHEEL DRIVE
CYL.	CYLINDER
DOHC	DOUBLE OVERHEAD CAM
DR	DOOR
DRW	DUAL REAL WHEEL
ENG	ENGINE
EXC	EXCLUDE
EXT	EXTENDED
F	FRONT
FWD	FRONT WHEEL DRIVE
GW	GROSS VEHICLE WEIGHT
HD	HEAVY DUTY
HP	HORSE POWER
L	LITRE
L	LEFT
LBS.	POUND
M/T	MANUAL TRANSMISSION
MM	MILLIMETER
N/A	NOT APPLICABLE / NOT AVAILABLE
NO.	NUMBER
OE	ORIGINAL EQUIPMENT
PKG	PACKAGE
R	REAR
R	RIGHT
REG	REGULAR
REQ'D	REQUIRED
RWD	REAL WHEEL DRIVE
SOHC	SINGLE OVERHEAD CAM
SRW	SINGLE REAL WHEEL
STD	STANDARD
TBA	TO BE ANNOUNCED
USD	US DOLLAR
VIN	VEHICLE IDENTIFICATION NUMBER
W/	WITH
W/O	WITHOUT
2WD	2 WHEEL DRIVE
4WD	4 WHEEL DRIVE

## TABLE OF CONTENTS

1-24	BRAKE SYSTEM
25-29	CALIPER KIT
30-33	SERVICE PART
34-111	BRAKE DISC
112-158	BRAKE PAD
159-181	STAINLESS STEEL BRAKE LINE
182	AERO PART
183-185	MISCELLANEOUS
186	WHEEL CLEARANCE CHART

# BRAKE SYSTEM

MAKE/MODEL	YEAR	CHASSIS	AXLE	PART #	CALIPER		DISC		WHEEL CHART			NOTES
					PISTON	TYPE	SIZE(MM)	TYPE	A (MM)	B (MM)	C (MM)	
<b>ACURA</b>												
CL (3.2L, V6)	01-03	YA4	F	RBK003.01	4	FC4	330X23	1-PIECE	23	187	113	
			F	RBK003.02	4	FC4	330X30	2-PIECE	32	187	113	
			F	RBK003.03	4	FF4	355X32	2-PIECE	37	199	121	
			R	RBK107.01	2	FC2	330X30	2-PIECE	22	189	112	
			R	RBK107.02	4	FC4	330X30	2-PIECE	17	187	113	
CSX CANADA MODEL	06-07	CL9	F	RBK003.04	4	FC4	330X23	1-PIECE	23	187	113	
			F	RBK003.05	4	FC4	330X30	2-PIECE	32	187	113	
			F	RBK003.06	4	FF4	355X32	2-PIECE	37	199	121	
			R									
EL CANADA MODEL	97-05		F	RBK007.01	4	FC4	330X21	1-PIECE	25	187	113	
			R									
EL CANADA MODEL	06-		F	RBK003.04	4	FC4	330X23	1-PIECE	23	187	113	
			F	RBK003.05	4	FC4	330X30	2-PIECE	32	187	113	
			F	RBK003.06	4	FF4	355X32	2-PIECE	37	199	121	
INTEGRA (EXC TYPE R)	90-01	DA9, DC2/4	F	RBK004.01	4	FC4	330X21	1-PIECE	25	187	113	
			R									
INTEGRA TYPE R	97-01	DC2	F	RBK006.01	4	FC4-A	295X23	1-PIECE	25	174	96	
			F	RBK006.03	4	FC4	330X30	2-PIECE	32	187	113	
			R									
MDX	01-06	YD18	F	RBK003.10	6	FC6	355X32	2-PIECE	45	201	122	
NSX	91-05	NA1/2	F	RBK044.01	4	FC4	330X30	2-PIECE	39	187	113	
			F	RBK044.03	4	FF4	355X32	2-PIECE	42	199	121	
			F	RBK044.02	6	FC6	355X32	2-PIECE	51	201	122	
			R	RBK110.01	4	FC4-B	330X30	2-PIECE	46	187	113	B
			R	RBK110.02	4	FC4	355X32	2-PIECE	48	199	125	B
RDX	07	KB16	F	RBK221.01	6	FC6	355X32	2-PIECE	45	201	122	C
			R	RBK222.01	4	FC4	355X32	2-PIECE	24	199	125	C
RSX, RSX-S (INTEGRA, INTEGRA TYPE-S) USA MODEL	02-06	DC5	F	RBK001.01	4	FC4	330X25	1-PIECE	22	187	113	
			F	RBK001.02	4	FC4	330X30	2-PIECE	27	187	113	
			F	RBK001.03	4	FF4	355X32	2-PIECE	30	199	121	
			F	RBK001.04	6	FC6	330X30	2-PIECE	42	191	108	
			R	RBK138.01	2	FC2	330X30	2-PIECE	36	189	112	B
TL, TL TYPE-S	99-03	UA4/5	F	RBK003.01	4	FC4	330X23	1-PIECE	23	187	113	
			F	RBK003.02	4	FC4	330X30	2-PIECE	32	187	113	
			F	RBK003.03	4	FF4	355X32	2-PIECE	37	199	121	
			R	RBK140.01	2	FC2	330X30	2-PIECE	22	189	112	
			R	RBK140.02	4	FC4	330X30	2-PIECE	17	187	113	
TL, TL TYPE-S (STD FRONT CALIPER)	04-07	UA6	F	RBK003.04	4	FC4	330X23	1-PIECE	23	187	113	
			F	RBK003.05	4	FC4	330X30	2-PIECE	32	187	113	
			F	RBK003.06	4	FF4	355X32	2-PIECE	37	199	121	
			R	RBK140.03	2	FC2	330X30	2-PIECE	22	189	112	
			R	RBK140.04	4	FC4	330X30	2-PIECE	17	187	113	
TL, TL TYPE-S (BREMBO FRONT CALIPER)	04-07	UA6	F	RBK109.01	4	FF4	355X32	2-PIECE	35	199	121	
			R	RBK140.03	2	FC2	330X30	2-PIECE	22	189	112	
			R	RBK140.04	4	FC4	330X30	2-PIECE	17	187	113	
			R									
TSX (ACCORD)	04-07	CL7-9 CM2/3	F	RBK003.04	4	FC4	330X23	1-PIECE	23	187	113	
			F	RBK003.05	4	FC4	330X30	2-PIECE	32	187	113	
			F	RBK003.06	4	FF4	355X32	2-PIECE	37	199	121	
			R									
<b>AUDI</b>												
ALL ROAD	01-06	C5	F	RBK056.04	4	FC4	330X30	2-PIECE	32	187	113	
			F	RBK057.01	6	FC6	355X32	2-PIECE	45	201	122	
			R									
A3, A3 QUATTRO EUROPE MODEL	96-04	8L	F	RBK052.01	4	FC4	330X30	2-PIECE	44	187	113	
			F	RBK052.03	4	FF4	355X32	2-PIECE	47	199	121	
			R									
A3 USA MODEL	06-08	B7	F	RBK111.01	4	FC4	330X30	2-PIECE	29	187	113	
A4, A4 QUATTRO	96-01	B5	F	RBK056.01	4	FC4	330X30	2-PIECE	32	187	113	
			F	RBK056.02	4	FF4	355X32	2-PIECE	35	199	121	
			R									
A4, A4 QUATTRO	02-07	B6, B7	F	RBK056.04	4	FC4	330X30	2-PIECE	32	187	113	
			F	RBK057.01	6	FC6	355X32	2-PIECE	45	201	122	
			R	RBK155.01	4	FC4	355X32	2-PIECE	45	199	125	B

# BRAKE SYSTEM

MAKE/MODEL	YEAR	CHASSIS	AXLE	PART #	CALIPER		DISC		WHEEL CHART			NOTES
					PISTON	TYPE	SIZE(MM)	TYPE	A (MM)	B (MM)	C (MM)	
A6	98-04	C5	F	RBK056.03	4	FC4	330X30	2-PIECE	32	187	113	
			F	RBK057.02	6	FC6	355X32	2-PIECE	45	201	122	
			R									
A6 QUATTRO (4.2L V8)	6/99-01	C5	F	RBK057.03	6	FC6	355X32	2-PIECE	45	201	122	
A6 QUATTRO (2.8L, 2.7L TURBO)	98-01	C5	F	RBK056.03	4	FC4	330X30	2-PIECE	32	187	113	
			F	RBK057.02	6	FC6	355X32	2-PIECE	45	201	122	
			R									
A6 QUATTRO (4.2L V8, 2.7L TURBO) W/ 4 PAD FRONT CALIPER	02-04	C5	F	RBK057.03	6	FC6	355X32	2-PIECE	45	201	122	
A6 QUATTRO (3.0L, 2.7L TURBO) W/ 2 PAD FRONT CALIPER	02-04	C5	F	RBK056.03	4	FC4	330X30	2-PIECE	32	187	113	
			F	RBK057.02	6	FC6	355X32	2-PIECE	45	201	122	
			R									
A8, A8 QUATTRO	04-07		F	RBK112.02	6	FC6	355X32	2-PIECE	32	201	122	
			F	RBK112.01	8	FC8	380X34	2-PIECE	34	217	126	
			R									
Q7	07-08		F	RBK095.01	8	FC8	405X36	2-PIECE	25	228	138	
			F	RBK095.02	12	FC12	405X36	2-PIECE	26	228	151	
			R	RBK189.01	4	FF4	380X34	2-PIECE	10	209	134	
S3	99-04	8L	F	RBK052.02	4	FC4	330X30	2-PIECE	44	187	113	
			F	RBK052.04	4	FF4	355X32	2-PIECE	47	199	121	
			R									
S4	2/99-02	B5	F	RBK056.03	4	FC4	330X30	2-PIECE	32	187	113	
			F	RBK057.02	6	FC6	355X32	2-PIECE	45	201	122	
			R									
S4	04-07	B6	F	RBK056.04	4	FC4	330X30	2-PIECE	32	187	113	
			F	RBK057.01	6	FC6	355X32	2-PIECE	45	201	122	
			R	RBK155.01	4	FC4	355X32	2-PIECE	45	199	125	B
S6	02-06	C5	F	RBK057.03	6	FC6	355X32	2-PIECE	45	201	122	
			R									
TT, TT QUATTRO	3/99-06	8N	F	RBK052.02	4	FC4	330X30	2-PIECE	44	187	113	
			F	RBK052.04	4	FF4	355X32	2-PIECE	47	199	121	
			R									
<b>BMW</b>												
M3	95-99	E36	F	RBK025.01	4	FC4	330X30	2-PIECE	25	187	113	
			F	RBK025.02	6	FC6	355X32	2-PIECE	37	201	122	
			R	RBK026.01	4	FC4	330X30	2-PIECE	18	187	113	
M3 (EXC COMPETITION PKG)	01-07	E46	F	RBK038.01	6	FC6	355X32	2-PIECE	40	201	122	
			F	RBK038.02	8	FC8	380X34	2-PIECE	41	217	126	
			R	RBK039.01	4	FC4	355X32	2-PIECE	21	199	125	
M3 (W/ COMPETITION PKG): CSL	06-07	E46	F	RBK038.01	6	FC6	355X32	2-PIECE	40	201	122	
			F	RBK038.02	8	FC8	380X34	2-PIECE	41	217	126	
			R	RBK202.01	4	FC4	355X32	2-PIECE	20	199	125	C
M5	85-87	E28	F	RBK187.01	6	FC6	355X32	2-PIECE	16	201	122	
			R									
M5	88-95	E34	F	RBK187.01	6	FC6	355X32	2-PIECE	16	201	122	
			R	RBK188.01	4	FC4	355X32	2-PIECE	21	199	125	
M5	00-04	E39	F	RBK064.01	6	FC6	355X32	2-PIECE	14	201	122	
			F	RBK064.02	8	FC8	380X34	2-PIECE	16	217	126	
			R	RBK039.02	4	FC4	355X32	2-PIECE	21	199	125	
M5	06-07	E60	F	RBK159.01	8	FC8	380X34	2-PIECE	17	217	126	
			F	RBK159.02	12	FC12	405X36	2-PIECE	19	228	151	
			R	RBK160.01	4	FF4	380X34	2-PIECE	23	209	134	
M6	87-88	E28	F	RBK187.01	6	FC6	355X32	2-PIECE	16	201	122	
			R									
M6	07-	E63/64	F	RBK159.01	8	FC8	380X34	2-PIECE	17	217	126	
			F	RBK159.02	12	FC12	405X36	2-PIECE	19	228	151	
			R	RBK160.01	4	FF4	380X34	2-PIECE	23	209	134	
X5	00-06	E53	F	RBK040.01	6	FC6	355X32	2-PIECE	29	201	122	
			F	RBK040.02	8	FC8	405X36	2-PIECE	32	228	138	
			R	RBK041.01	4	FC4	355X32	2-PIECE	1	199	125	
			R	RBK041.02	4	FF4	380X34	2-PIECE	3	209	134	
Z3 (EXC M SERIES)	96-02	E36	F	RBK049.01	6	FC6	355X32	2-PIECE	40	201	122	
Z3 (M SERIES)	98-02	E36/37	F	RBK025.01	4	FC4	330X30	2-PIECE	25	187	113	
			F	RBK025.02	6	FC6	355X32	2-PIECE	37	201	122	
			R	RBK148.01	4	FC4	330X30	2-PIECE	18	187	113	

# BRAKE SYSTEM

MAKE/MODEL	YEAR	CHASSIS	AXLE	PART #	CALIPER		DISC		WHEEL CHART			NOTES
					PISTON	TYPE	SIZE(MM)	TYPE	A (MM)	B (MM)	C (MM)	
Z4 (EXC M SERIES)	03-07	E85/86	F	RBK049.01	6	FC6	355X32	2-PIECE	40	201	122	
			R	RBK050.01	4	FC4	355X32	2-PIECE	11	199	125	
Z4 (M SERIES): 3.2L	06-07	E86	F	RBK038.01	6	FC6	355X32	2-PIECE	40	201	122	
			F	RBK038.02	8	FC8	380X34	2-PIECE	41	217	126	
			R	RBK202.01	4	FC4	355X32	2-PIECE	20	199	125	C
318, 323, 325, 328 SERIES	90-99	E36	F	RBK049.01	6	FC6	355X32	2-PIECE	40	201	122	
			R	RBK104.01	4	FC4	355X32	2-PIECE	21	199	125	
323, 325, 328 SERIES	99-07	E46	F	RBK049.01	6	FC6	355X32	2-PIECE	40	201	122	
			R	RBK137.01	4	FC4	355X32	2-PIECE	26	199	125	
325, 328 SERIES	06-07	E90/91/92	F	RBK113.01	6	FC6	355X32	2-PIECE	19	201	122	
			F	RBK113.02	8	FC8	380X34	2-PIECE	21	217	126	C
			R	RBK114.01	4	FC4	355X32	2-PIECE	15	199	125	
330 SERIES	00-07	E46	F	RBK049.01	6	FC6	355X32	2-PIECE	40	201	122	
			R	RBK083.01	4	FC4	355X32	2-PIECE	32	199	125	
330 SERIES	06	E90	F	RBK113.01	6	FC6	355X32	2-PIECE	19	201	122	
			F	RBK113.02	8	FC8	380X34	2-PIECE	21	217	126	C
			R	RBK114.02	4	FC4	355X32	2-PIECE	19	199	125	
335 SERIES	07	E90/92	F	RBK113.03	6	FC6	355X32	2-PIECE	19	201	122	C
			F	RBK113.04	8	FC8	380X34	2-PIECE	21	217	126	C
			R	RBK114.02	4	FC4	355X32	2-PIECE	19	199	125	
5 SERIES	81-87	E28	F	RBK187.01	6	FC6	355X32	2-PIECE	16	201	122	
5 SERIES	88-95	E34	F	RBK187.01	6	FC6	355X32	2-PIECE	16	201	122	
			R	RBK188.01	4	FC4	355X32	2-PIECE	21	199	125	
5 SERIES	96-03	E39	F	RBK064.01	6	FC6	355X32	2-PIECE	14	201	122	
			F	RBK064.02	8	FC8	380X34	2-PIECE	16	217	126	
			R	RBK039.02	4	FC4	355X32	2-PIECE	21	199	125	
5 SERIES	04-07	E60/61	F	RBK127.01	8	FC8	380X34	2-PIECE	17	217	126	
			F	RBK127.02	12	FC12	405X36	2-PIECE	19	228	151	
			R	RBK128.01	4	FF4	380X34	2-PIECE	23	209	134	
6 SERIES	76-90	E24	F	RBK187.01	6	FC6	355X32	2-PIECE	16	201	122	
6 SERIES	04-07	E63/64	F	RBK127.01	8	FC8	380X34	2-PIECE	17	217	126	
			F	RBK127.02	12	FC12	405X36	2-PIECE	19	228	151	
			R	RBK128.01	4	FF4	380X34	2-PIECE	23	209	134	
7 SERIES	86-94	E32	F	RBK187.01	6	FC6	355X32	2-PIECE	16	201	122	
			R	RBK188.01	4	FC4	355X32	2-PIECE	21	199	125	
7 SERIES	95-01	E38	F	RBK151.01	6	FC6	355X32	2-PIECE	13	201	122	
			F	RBK151.02	8	FC8	380X34	2-PIECE	16	217	126	
			R	RBK039.03	4	FC4	355X32	2-PIECE	21	199	125	
7 SERIES	02-3/05	E65/66	F	RBK127.03	8	FC8	380X34	2-PIECE	14	217	126	
			F	RBK127.04	12	FC12	405X36	2-PIECE	16	228	151	
			R	RBK128.02	4	FF4	380X34	2-PIECE	20	209	134	
7 SERIES	3/05-07	E65/66	F	RBK127.03	8	FC8	380X34	2-PIECE	14	217	126	
			F	RBK127.04	12	FC12	405X36	2-PIECE	16	228	151	
			R	RBK128.03	4	FF4	380X34	2-PIECE	13	209	134	
8 SERIES	90-97	E31	F	RBK187.01	6	FC6	355X32	2-PIECE	16	201	122	
			R	RBK200.01	4	FC4	355X32	2-PIECE	21	199	125	
<b>BUICK</b>												
RAINER	04-07		F	RBK091.01	6	FC6	355X32	2-PIECE	37	201	122	
			F	RBK091.02	8	FC8	380X34	2-PIECE	39	217	126	
			R	RBK092.01	4	FF4	380X34	2-PIECE	-2	209	134	G
<b>CADILLAC</b>												
CTS (EXC V-SERIES)	03-07		F	RBK125.01	6	FC6	355X32	2-PIECE	40	201	122	
			F	RBK125.02	8	FC8	380X34	2-PIECE	42	217	126	
			R	RBK126.01	4	FC4-A	355X32	2-PIECE	34	199	125	
			R	RBK126.02	4	FF4	380X34	2-PIECE	42	209	134	
CTS-V	04-07		F	RBK168.01	8	FC8	380X34	2-PIECE	42	217	126	
			R	RBK169.01	4	FF4	380X34	2-PIECE	42	209	134	
ESCALADE, ESV, EXT	02-06		F	RBK070.01	8	FC8	405X36	2-PIECE	31	228	138	
			F	RBK070.02	12	FC12	405X36	2-PIECE	32	228	151	
			R	RBK071.01	4	FC4	355X32	2-PIECE	-14	199	125	
			R	RBK071.02	4	FF4	380X34	2-PIECE	-12	209	134	
ESCALADE, ESV, EXT	07-		F	RBK165.01	8	FC8	405X36	2-PIECE	31	228	138	
			F	RBK165.02	12	FC12	405X36	2-PIECE	32	228	151	
			R	RBK166.01	4	FC4	355X32	2-PIECE	-14	199	125	F

# BRAKE SYSTEM

MAKE/MODEL	YEAR	CHASSIS	AXLE	PART #	CALIPER		DISC		WHEEL CHART			NOTES
					PISTON	TYPE	SIZE (MM)	TYPE	A (MM)	B (MM)	C (MM)	
STS (EXC V-SERIES)	05-07		R	RBK166.02	4	FF4	380X34	2-PIECE	-12	209	134	F
			F	RBK125.03	6	FC6	355X32	2-PIECE	40	201	122	
			F	RBK125.04	8	FC8	380X34	2-PIECE	42	217	126	
			R	RBK126.01	4	FC4-A	355X32	2-PIECE	34	199	125	
STS-V	06-07		R	RBK126.02	4	FF4	380X34	2-PIECE	42	209	134	
			F	RBK168.02	8	FC8	380X34	2-PIECE	42	217	126	
XLR (ALL MODEL)	04-07		R	RBK169.01	4	FF4	380X34	2-PIECE	42	209	134	
			F	RBK123.01	6	FC6	355X32	2-PIECE	48	201	122	
			F	RBK123.02	8	FC8	380X34	2-PIECE	50	217	126	
			R	RBK124.01	4	FC4	355X32	2-PIECE	32	199	125	
<b>CHEVROLET</b>												
AVALANCHE 1500	02-06		F	RBK070.01	8	FC8	405X36	2-PIECE	31	228	138	
			F	RBK070.02	12	FC12	405X36	2-PIECE	32	228	151	
			R	RBK071.01	4	FC4	355X32	2-PIECE	-14	199	125	
			R	RBK071.02	4	FF4	380X34	2-PIECE	-12	209	134	
AVALANCHE 1500	07-		F	RBK165.01	8	FC8	405X36	2-PIECE	31	228	138	
			F	RBK165.02	12	FC12	405X36	2-PIECE	32	228	151	
			R	RBK166.01	4	FC4	355X32	2-PIECE	-14	199	125	F
			R	RBK166.02	4	FF4	380X34	2-PIECE	-12	209	134	F
AVALANCHE 2500	02		F	RBK045.01	8	FC8	405X36	2-PIECE	5	228	138	
			F	RBK045.02	12	FC12	405X36	2-PIECE	5	228	151	
			R	RBK077.02	4	FF4	380X34	2-PIECE	-3	209	134	
AVALANCHE 2500	03-06		F	RBK045.01	8	FC8	405X36	2-PIECE	5	228	138	
			F	RBK045.02	12	FC12	405X36	2-PIECE	5	228	151	
			R	RBK077.03	4	FF4	380X34	2-PIECE	-3	209	134	
AVALANCHE 2500	07-		F	RBK045.01	8	FC8	405X36	2-PIECE	5	228	138	
			F	RBK045.02	12	FC12	405X36	2-PIECE	5	228	151	
			R	RBK077.02	4	FF4	380X34	2-PIECE	-3	209	134	
CAMARO	98-02		F	RBK081.01	4	FC4	330X30	2-PIECE	27	187	113	
			R									
CAVALIER (CADET)	92-05	JG00	F	RBK068.01	4	FC4	330X30	2-PIECE	31	187	113	A, E
CORVETTE (ALL MODEL)	97-04	C5	F	RBK212.01	6	FC6	355X32	2-PIECE	48	201	122	
			F	RBK212.02	8	FC8	380X34	2-PIECE	50	217	126	
			R	RBK213.01	4	FC4	355X32	2-PIECE	32	199	125	
CORVETTE (ALL MODEL)	05-07	C6	F	RBK123.01	6	FC6	355X32	2-PIECE	48	201	122	
			F	RBK123.02	8	FC8	380X34	2-PIECE	50	217	126	
			R	RBK124.01	4	FC4	355X32	2-PIECE	32	199	125	
SILVERADO 1500 (2WD, 4WD) EXC HD	99-04		F	RBK070.01	8	FC8	405X36	2-PIECE	31	228	138	
			F	RBK070.02	12	FC12	405X36	2-PIECE	32	228	151	
			R	RBK071.01	4	FC4	355X32	2-PIECE	-14	199	125	
			R	RBK071.02	4	FF4	380X34	2-PIECE	-12	209	134	
SILVERADO 1500 (2WD, 4WD) HD	01-03		F	RBK045.01	8	FC8	405X36	2-PIECE	5	228	138	
			F	RBK045.02	12	FC12	405X36	2-PIECE	5	228	151	
			R	RBK077.02	4	FF4	380X34	2-PIECE	-3	209	134	
SILVERADO 1500 (2WD, 4WD) HD W/ 4.63" REAR HUB HOLE	04		F	RBK045.01	8	FC8	405X36	2-PIECE	5	228	138	
			F	RBK045.02	12	FC12	405X36	2-PIECE	5	228	151	
			R	RBK077.02	4	FF4	380X34	2-PIECE	-3	209	134	
SILVERADO 1500 (2WD, 4WD) HD W/ 4.83" REAR HUB HOLE	04		F	RBK045.01	8	FC8	405X36	2-PIECE	5	228	138	
			F	RBK045.02	12	FC12	405X36	2-PIECE	5	228	151	
			R	RBK077.03	4	FF4	380X34	2-PIECE	-7	209	134	
SILVERADO 1500 (2WD, 4WD) EXC HD	05-06		F	RBK070.01	8	FC8	405X36	2-PIECE	31	228	138	
			F	RBK070.02	12	FC12	405X36	2-PIECE	32	228	151	
			R	RBK071.01	4	FC4	355X32	2-PIECE	-14	199	125	
			R	RBK071.02	4	FF4	380X34	2-PIECE	-12	209	134	
SILVERADO 1500 (2WD, 4WD) HD	05-06		F	RBK045.01	8	FC8	405X36	2-PIECE	5	228	138	
			F	RBK045.02	12	FC12	405X36	2-PIECE	5	228	151	
			R	RBK077.02	4	FF4	380X34	2-PIECE	-3	209	134	
SILVERADO 1500 (2WD, 4WD)	07-		F	RBK165.01	8	FC8	405X36	2-PIECE	31	228	138	
			F	RBK165.02	12	FC12	405X36	2-PIECE	32	228	151	
			R	RBK166.01	4	FC4	355X32	2-PIECE	-14	199	125	F
			R	RBK166.02	4	FF4	380X34	2-PIECE	-12	209	134	F
SILVERADO 2500 (2WD, 4WD) EXC HD (A/T) W/ 4.63" REAR HUB HOLE	99-04		F	RBK045.01	8	FC8	405X36	2-PIECE	5	228	138	
			F	RBK045.02	12	FC12	405X36	2-PIECE	5	228	151	
			R	RBK077.02	4	FF4	380X34	2-PIECE	-3	209	134	
SILVERADO 2500 (2WD, 4WD) EXC HD (M/T) W/ 4.83" REAR HUB HOLE	99-05		F	RBK045.01	8	FC8	405X36	2-PIECE	5	228	138	
			F	RBK045.02	12	FC12	405X36	2-PIECE	5	228	151	

# BRAKE SYSTEM

MAKE/MODEL	YEAR	CHASSIS	AXLE		CALIPER		DISC		WHEEL CHART			NOTES
			F/R	PART #	PISTON	TYPE	SIZE(MM)	TYPE	A (MM)	B (MM)	C (MM)	
SILVERADO 2500 (2WD, 4WD) HD	01-07		R	RBK077.03	4	FF4	380X34	2-PIECE	-7	209	134	
			F	RBK045.01	8	FC8	405X36	2-PIECE	5	228	138	
			F	RBK045.02	12	FC12	405X36	2-PIECE	5	228	151	
			R	RBK077.03	4	FF4	380X34	2-PIECE	-7	209	134	
SILVERADO 3500 (2WD) DRW	01-07		F	RBK045.01	8	FC8	405X36	2-PIECE	5	228	138	
			F	RBK045.02	12	FC12	405X36	2-PIECE	5	228	151	
			R									
SILVERADO 3500 (2WD) SRW	06-07		F	RBK045.01	8	FC8	405X36	2-PIECE	5	228	138	
			F	RBK045.02	12	FC12	405X36	2-PIECE	5	228	151	
			R	RBK077.03	4	FF4	380X34	2-PIECE	-7	209	134	
SILVERADO 3500 (4WD) DRW	01-07		F	RBK045.01	8	FC8	405X36	2-PIECE	5	228	138	
			F	RBK045.02	12	FC12	405X36	2-PIECE	5	228	151	
			R									
SILVERADO 3500 (4WD) SRW	04-07		F	RBK045.01	8	FC8	405X36	2-PIECE	5	228	138	
			F	RBK045.02	12	FC12	405X36	2-PIECE	5	228	151	
			R	RBK077.03	4	FF4	380X34	2-PIECE	-7	209	134	
SSR	03-07		F	RBK091.01	6	FC6	355X32	2-PIECE	37	201	122	
			F	RBK091.02	8	FC8	380X34	2-PIECE	39	217	126	
			R	RBK092.01	4	FF4	380X34	2-PIECE	-2	209	134	G
SUBURBAN 1500 (2WD, 4WD)	00-06		F	RBK070.01	8	FC8	405X36	2-PIECE	31	228	138	
			F	RBK070.02	12	FC12	405X36	2-PIECE	32	228	151	
			R	RBK071.01	4	FC4	355X32	2-PIECE	-14	199	125	
			R	RBK071.02	4	FF4	380X34	2-PIECE	-12	209	134	
SUBURBAN 1500 (2WD, 4WD)	07-		F	RBK165.01	8	FC8	405X36	2-PIECE	31	228	138	
			F	RBK165.02	12	FC12	405X36	2-PIECE	32	228	151	
			R	RBK166.01	4	FC4	355X32	2-PIECE	-14	199	125	F
			R	RBK166.02	4	FF4	380X34	2-PIECE	-12	209	134	F
SUBURBAN 2500 (2WD, 4WD) 2 WHEEL STEERING W/ 4.63" REAR HUB HOLE	00-06		F	RBK045.01	8	FC8	405X36	2-PIECE	5	228	138	
			F	RBK045.02	12	FC12	405X36	2-PIECE	5	228	151	
			R	RBK077.02	4	FF4	380X34	2-PIECE	-3	209	134	
SUBURBAN 2500 (2WD, 4WD) 2 WHEEL STEERING W/ 4.83" REAR HUB HOLE	00-06		F	RBK045.01	8	FC8	405X36	2-PIECE	5	228	138	
			F	RBK045.02	12	FC12	405X36	2-PIECE	5	228	151	
			R	RBK077.03	4	FF4	380X34	2-PIECE	-7	209	134	
SUBURBAN 2500 (2WD, 4WD) 4 WHEEL STEERING	03-05		F	RBK045.01	8	FC8	405X36	2-PIECE	5	228	138	
			F	RBK045.02	12	FC12	405X36	2-PIECE	5	228	151	
			R									
SUBURBAN 2500 (2WD, 4WD)	07		F	RBK045.01	8	FC8	405X36	2-PIECE	5	228	138	
			F	RBK045.02	12	FC12	405X36	2-PIECE	5	228	151	
			R	RBK077.02	4	FF4	380X34	2-PIECE	-3	209	134	
TAHOE (2WD, 4WD)	00-06		F	RBK070.01	8	FC8	405X36	2-PIECE	31	228	138	
			F	RBK070.02	12	FC12	405X36	2-PIECE	32	228	151	
			R	RBK071.01	4	FC4	355X32	2-PIECE	-14	199	125	
			R	RBK071.02	4	FF4	380X34	2-PIECE	-12	209	134	
TAHOE (2WD, 4WD)	07-		F	RBK165.01	8	FC8	405X36	2-PIECE	31	228	138	
			F	RBK165.02	12	FC12	405X36	2-PIECE	32	228	151	
			R	RBK166.01	4	FC4	355X32	2-PIECE	-14	199	125	F
			R	RBK166.02	4	FF4	380X34	2-PIECE	-12	209	134	F
TRAILBLAZER	02-07		F	RBK091.01	6	FC6	355X32	2-PIECE	37	201	122	
			F	RBK091.02	8	FC8	380X34	2-PIECE	39	217	126	
			R	RBK092.01	4	FF4	380X34	2-PIECE	-2	209	134	G
<b>CHRYSLER</b>												
CROSSFIRE	04-05	ZH32/32C	F	RBK149.01	4	FC4	330X30	2-PIECE	33	187	113	
			F	RBK149.02	6	FC6	355X32	2-PIECE	45	201	122	
			R	RBK098.02	4	FC4	330X30	2-PIECE	25	187	113	
			R	RBK098.01	4	FC4	355X32	2-PIECE	27	199	125	
PT CRUISER	01-07	PT24/24T	F	RBK046.01	4	FC4	330X30	2-PIECE	40	187	113	
SEBRING CONVERTIBLE	08		F	RBK220.01	4	FC4	330X24	1-PIECE	28	187	113	C
			F	RBK220.02	4	FC4	330X30	2-PIECE	34	187	113	C
			F	RBK220.03	4	FF4	355X32	2-PIECE	37	199	121	C
			F	RBK220.04	6	FC6	355X32	2-PIECE	46	201	122	C
SEBRING COUPE	95-00		F	RBK002.02	4	FC4	330X24	1-PIECE	28	187	113	
			F	RBK002.05	4	FC4	330X30	2-PIECE	34	187	113	
			R	RBK141.01	2	FC2	330X30	2-PIECE	24	189	112	F
			R	RBK141.02	4	FC4	330X30	2-PIECE	19	187	113	F
SEBRING COUPE	01-05		F	RBK018.01	4	FC4	330X24	1-PIECE	28	187	113	

# BRAKE SYSTEM

MAKE/MODEL	YEAR	CHASSIS	AXLE		CALIPER		DISC		WHEEL CHART			NOTES
			F/R	PART #	PISTON	TYPE	SIZE(MM)	TYPE	A (MM)	B (MM)	C (MM)	
			F	RBK018.02	4	FC4	330X30	2-PIECE	34	187	113	
			R	RBK141.01	2	FC2	330X30	2-PIECE	24	189	112	F
			R	RBK141.02	4	FC4	330X30	2-PIECE	19	187	113	F
SEBRING SEDAN	07		F	RBK220.01	4	FC4	330X24	1-PIECE	28	187	113	C
			F	RBK220.02	4	FC4	330X30	2-PIECE	34	187	113	C
			F	RBK220.03	4	FF4	355X32	2-PIECE	37	199	121	C
			F	RBK220.04	6	FC6	355X32	2-PIECE	46	201	122	C
			R									
300, 300C (EXC SRT-8)	05-07		F	RBK066.01	6	FC6	355X32	2-PIECE	39	201	122	
			F	RBK066.02	8	FC8	405X36	2-PIECE	43	228	138	
			R	RBK067.01	4	FC4	355X32	2-PIECE	18	199	125	
			R	RBK067.02	4	FF4	380X34	2-PIECE	23	209	134	
300C SRT-8	06-07		F	RBK152.01	8	FC8	405X36	2-PIECE	43	228	138	
			F	RBK152.02	12	FC12	405X36	2-PIECE	45	228	151	
			R	RBK153.01	4	FF4	380X34	2-PIECE	23	209	134	
<b>CITROËN</b>												
XSARA	4/97-		F	RBK142.01	4	FC4	330X30	2-PIECE	45	187	113	
EUROPE MODEL			R									
ZX	7/92-9/97		F	RBK142.01	4	FC4	330X30	2-PIECE	45	187	113	
EUROPE MODEL			R									
<b>DODGE</b>												
AVENGER	95-00		F	RBK002.02	4	FC4	330X24	1-PIECE	28	187	113	
			F	RBK002.05	4	FC4	330X30	2-PIECE	34	187	113	
			R	RBK141.01	2	FC2	330X30	2-PIECE	24	189	112	F
			R	RBK141.02	4	FC4	330X30	2-PIECE	19	187	113	F
AVENGER (SE, SXT, R/T)	08		F	RBK220.01	4	FC4	330X24	1-PIECE	28	187	113	C
			F	RBK220.02	4	FC4	330X30	2-PIECE	34	187	113	C
			F	RBK220.03	4	FF4	355X32	2-PIECE	37	199	121	C
			F	RBK220.04	6	FC6	355X32	2-PIECE	46	201	122	C
			R									
CALIBER (SE, SXT, R/T); EXC SRT	07		F	RBK220.01	4	FC4	330X24	1-PIECE	28	187	113	C
			F	RBK220.02	4	FC4	330X30	2-PIECE	34	187	113	C
			F	RBK220.03	4	FF4	355X32	2-PIECE	37	199	121	C
			F	RBK220.04	6	FC6	355X32	2-PIECE	46	201	122	C
			R									
CHARGER (EXC SRT-8)	06-07		F	RBK066.01	6	FC6	355X32	2-PIECE	39	201	122	
			F	RBK066.02	8	FC8	405X36	2-PIECE	43	228	138	
			R	RBK067.01	4	FC4	355X32	2-PIECE	18	199	125	
			R	RBK067.02	4	FF4	380X34	2-PIECE	23	209	134	
CHARGER SRT-8	06-07		F	RBK152.01	8	FC8	405X36	2-PIECE	43	228	138	
			F	RBK152.02	12	FC12	405X36	2-PIECE	45	228	151	
			R	RBK153.01	4	FF4	380X34	2-PIECE	23	209	134	
DURANGO	04-07		F	RBK117.02	8	FC8	405X36	2-PIECE	27	228	138	
			F	RBK117.04	12	FC12	405X36	2-PIECE	28	228	151	
			R	RBK118.02	4	FF4	380X34	2-PIECE	12	209	134	
MAGNUM (SE, SXT, R/T); EXC SRT-8	05-07		F	RBK066.01	6	FC6	355X32	2-PIECE	39	201	122	
			F	RBK066.02	8	FC8	405X36	2-PIECE	43	228	138	
			R	RBK067.01	4	FC4	355X32	2-PIECE	18	199	125	
			R	RBK067.02	4	FF4	380X34	2-PIECE	23	209	134	
MAGNUM SRT-8	06-07		F	RBK152.01	8	FC8	405X36	2-PIECE	43	228	138	
			F	RBK152.02	12	FC12	405X36	2-PIECE	45	228	151	
			R	RBK153.01	4	FF4	380X34	2-PIECE	23	209	134	
RAM 1500 (2WD, 4WD)	02-07		F	RBK117.01	8	FC8	405X36	2-PIECE	27	228	138	
			F	RBK117.03	12	FC12	405X36	2-PIECE	28	228	151	
			R	RBK118.01	4	FF4	380X34	2-PIECE	12	209	134	G
SRT-4	03-05	PLDS41	F	RBK046.01	4	FC4	330X30	2-PIECE	40	187	113	
			R									
STEALTH (2WD)	91-96	D21A, D22A, D27A	F	RBK002.01	4	FC4	330X24	1-PIECE	28	187	113	
			F	RBK002.04	4	FC4	330X30	2-PIECE	34	187	113	
			F	RBK002.07	4	FF4	355X32	2-PIECE	37	199	121	
			F	RBK002.10	6	FC6	355X32	2-PIECE	46	201	122	
			R									
STEALTH (AWD)	91-96	Z16A	F	RBK060.01	6	FC6	355X32	2-PIECE	46	201	122	
			R	RBK157.02	4	FC4	355X32	2-PIECE	29	199	125	
STRATUS COUPE	01-05		F	RBK018.01	4	FC4	330X24	1-PIECE	28	187	113	
			F	RBK018.02	4	FC4	330X30	2-PIECE	34	187	113	

# BRAKE SYSTEM

MAKE/MODEL	YEAR	CHASSIS	AXLE	PART #	CALIPER		DISC		WHEEL CHART			NOTES
					PISTON	TYPE	SIZE(MM)	TYPE	A (MM)	B (MM)	C (MM)	
			F/R									
			R	RBK141.01	2	FC2	330X30	2-PIECE	24	189	112	F
			R	RBK141.02	4	FC4	330X30	2-PIECE	19	187	113	F
<b>EAGLE</b>												
TALON (EXC TURBO)	90-94		F	RBK002.01	4	FC4	330X24	1-PIECE	28	187	113	
			F	RBK002.04	4	FC4	330X30	2-PIECE	34	187	113	
			F	RBK002.07	4	FF4	355X32	2-PIECE	37	199	121	
			F	RBK002.10	6	FC6	355X32	2-PIECE	46	201	122	
			R									
TALON (EXC TURBO)	95-96		F	RBK002.02	4	FC4	330X24	1-PIECE	28	187	113	
			F	RBK002.05	4	FC4	330X30	2-PIECE	34	187	113	
			F	RBK002.08	4	FF4	355X32	2-PIECE	37	199	121	
			F	RBK002.11	6	FC6	355X32	2-PIECE	46	201	122	
			R	RBK141.01	2	FC2	330X30	2-PIECE	24	189	112	F
			R	RBK141.02	4	FC4	330X30	2-PIECE	19	187	113	F
TALON (EXC TURBO)	97-99		F	RBK002.02	4	FC4	330X24	1-PIECE	28	187	113	
			F	RBK002.05	4	FC4	330X30	2-PIECE	34	187	113	
			F	RBK002.08	4	FF4	355X32	2-PIECE	37	199	121	
			F	RBK002.11	6	FC6	355X32	2-PIECE	46	201	122	
			R									
TALON (TSi TURBO 2WD, 4WD) EXC 94 4WD	90-11/94		F	RBK002.01	4	FC4	330X24	1-PIECE	28	187	113	
			F	RBK002.04	4	FC4	330X30	2-PIECE	34	187	113	
			F	RBK002.07	4	FF4	355X32	2-PIECE	37	199	121	
			F	RBK002.10	6	FC6	355X32	2-PIECE	46	201	122	
			R									
TALON (TSi TURBO 2WD, 4WD) EXC 94 2WD	12/94-99		F	RBK002.02	4	FC4	330X24	1-PIECE	28	187	113	
			F	RBK002.05	4	FC4	330X30	2-PIECE	34	187	113	
			F	RBK002.08	4	FF4	355X32	2-PIECE	37	199	121	
			F	RBK002.11	6	FC6	355X32	2-PIECE	46	201	122	
			R	RBK141.01	2	FC2	330X30	2-PIECE	24	189	112	F
			R	RBK141.02	4	FC4	330X30	2-PIECE	19	187	113	F
<b>FERRARI</b>												
348	89-93		F	RBK191.01	6	FC6	355X32	2-PIECE	33	201	122	A
			F	RBK191.02	8	FC8	380X34	2-PIECE	34	217	126	A
			R	RBK214.01	4	FC4	355X32	2-PIECE	5	199	121	A
F355	94-99		F	RBK191.01	6	FC6	355X32	2-PIECE	33	201	122	A
			F	RBK191.02	8	FC8	380X34	2-PIECE	34	217	126	A
			R	RBK214.01	4	FC4	355X32	2-PIECE	5	199	121	A
360 MODENA (EXC CERAMIC DISC)	00-04		F	RBK196.01	8	FC8	405X36	2-PIECE	55	228	138	A
			R	RBK197.01	8	FC8	405X36	2-PIECE	55	228	138	A, B
F430 (EXC CERAMIC DISC)	05-07		F	RBK196.01	8	FC8	405X36	2-PIECE	55	228	138	A
			R	RBK197.01	8	FC8	405X36	2-PIECE	55	228	138	A, B
<b>FORD</b>												
EXPEDITION (2WD, 4WD)	3/02-06		F	RBK089.01	8	FC8	405X36	2-PIECE	46	228	138	
			R									
EXPLORER (EXC SPORT, SPORT TRAC)	02-05		F	RBK193.01	6	FC6	355X32	2-PIECE	37.3	201	122	A
			R									
FOCUS EUROPE MODEL (5X108MM PCD)	05-07		F	RBK161.02	4	FC4	330X30	2-PIECE	33	187	114	
			R									
FOCUS	05-07	DAW	F	RBK201.01	4	FC4	330X30	2-PIECE	37	187	114	C
			R									
FOCUS SVT	02-04	ST170	F	RBK201.01	4	FC4	330X30	2-PIECE	37	187	114	C
			R									
FUSION	06-07		F	RBK043.01	4	FC4	330X30	2-PIECE	31	187	113	
			R									
MUSTANG (ALL MODEL)	94-04	SN95	F	RBK020.01	4	FC4	330X28	1-PIECE	33	187	113	
			F	RBK020.02	6	FC6	355X32	2-PIECE	48	201	122	
			R									
MUSTANG (ALL MODEL)	05-07	S197	F	RBK096.01	6	FC6	355X32	2-PIECE	46	201	122	
			F	RBK096.02	8	FC8	380X34	2-PIECE	45	217	126	
			R									
THUNDERBIRD	93-97		F	RBK020.03	4	FC4	330X28	1-PIECE	33	187	113	
			F	RBK020.04	6	FC6	355X32	2-PIECE	48	201	122	
			R									
<b>GMC</b>												



# BRAKE SYSTEM

MAKE/MODEL	YEAR	CHASSIS	AXLE	PART #	CALIPER		DISC		WHEEL CHART			NOTES
					PISTON	TYPE	SIZE(MM)	TYPE	A (MM)	B (MM)	C (MM)	
ENVOY	02-07		F	RBK091.01	6	FC6	355X32	2-PIECE	37	201	122	G
			F	RBK091.02	8	FC8	380X34	2-PIECE	39	217	126	
			R	RBK092.01	4	FF4	380X34	2-PIECE	-2	209	134	
SIERRA 1500 (2WD, 4WD) EXC HD	99-06		F	RBK070.01	8	FC8	405X36	2-PIECE	31	228	138	
			F	RBK070.02	12	FC12	405X36	2-PIECE	32	228	151	
			R	RBK071.01	4	FC4	355X32	2-PIECE	-14	199	125	
			R	RBK071.02	4	FF4	380X34	2-PIECE	-12	209	134	
SIERRA 1500 (2WD, 4WD) HD	01-06		F	RBK045.01	8	FC8	405X36	2-PIECE	5	228	138	
			F	RBK045.02	12	FC12	405X36	2-PIECE	5	228	151	
			R	RBK077.02	4	FF4	380X34	2-PIECE	-3	209	134	
SIERRA 1500 (2WD, 4WD)	07-		F	RBK165.01	8	FC8	405X36	2-PIECE	31	228	138	F
			F	RBK165.02	12	FC12	405X36	2-PIECE	32	228	151	
			R	RBK166.01	4	FC4	355X32	2-PIECE	-14	199	125	
			R	RBK166.02	4	FF4	380X34	2-PIECE	-12	209	134	
SIERRA 2500 (2WD, 4WD) EXC HD (A/T) W/ 4.63" REAR HUB HOLE	99-04		F	RBK045.01	8	FC8	405X36	2-PIECE	5	228	138	
			F	RBK045.02	12	FC12	405X36	2-PIECE	5	228	151	
			R	RBK077.02	4	FF4	380X34	2-PIECE	-3	209	134	
SIERRA 2500 (2WD, 4WD) EXC HD (M/T) W/ 4.83" REAR HUB HOLE	99-05		F	RBK045.01	8	FC8	405X36	2-PIECE	5	228	138	
			F	RBK045.02	12	FC12	405X36	2-PIECE	5	228	151	
			R	RBK077.03	4	FF4	380X34	2-PIECE	-7	209	134	
SIERRA 2500 (2WD, 4WD) HD	01-07		F	RBK045.01	8	FC8	405X36	2-PIECE	5	228	138	
			F	RBK045.02	12	FC12	405X36	2-PIECE	5	228	151	
			R	RBK077.03	4	FF4	380X34	2-PIECE	-7	209	134	
SIERRA 3500 (2WD) DRW	01-07		F	RBK045.01	8	FC8	405X36	2-PIECE	5	228	138	
			F	RBK045.02	12	FC12	405X36	2-PIECE	5	228	151	
			R									
SIERRA 3500 (2WD) SRW	06-07		F	RBK045.01	8	FC8	405X36	2-PIECE	5	228	138	
			F	RBK045.02	12	FC12	405X36	2-PIECE	5	228	151	
			R	RBK077.03	4	FF4	380X34	2-PIECE	-7	209	134	
SIERRA 3500 (4WD) DRW	01-07		F	RBK045.01	8	FC8	405X36	2-PIECE	5	228	138	
			F	RBK045.02	12	FC12	405X36	2-PIECE	5	228	151	
			R									
SIERRA 3500 (4WD) SRW	04-07		F	RBK045.01	8	FC8	405X36	2-PIECE	5	228	138	
			F	RBK045.02	12	FC12	405X36	2-PIECE	5	228	151	
			R	RBK077.03	4	FF4	380X34	2-PIECE	-7	209	134	
YUKON (2WD, 4WD) EXC XL	00-06		F	RBK070.01	8	FC8	405X36	2-PIECE	31	228	138	
			F	RBK070.02	12	FC12	405X36	2-PIECE	32	228	151	
			R	RBK071.01	4	FC4	355X32	2-PIECE	-14	199	125	
			R	RBK071.02	4	FF4	380X34	2-PIECE	-12	209	134	
YUKON (2WD, 4WD) EXC XL	07-		F	RBK165.01	8	FC8	405X36	2-PIECE	31	228	138	F
			F	RBK165.02	12	FC12	405X36	2-PIECE	32	228	151	
			R	RBK166.01	4	FC4	355X32	2-PIECE	-14	199	125	
			R	RBK166.02	4	FF4	380X34	2-PIECE	-12	209	134	
YUKON XL (1/2 TON)	00-06		F	RBK070.01	8	FC8	405X36	2-PIECE	31	228	138	
			F	RBK070.02	12	FC12	405X36	2-PIECE	32	228	151	
			R	RBK071.01	4	FC4	355X32	2-PIECE	-14	199	125	
			R	RBK071.02	4	FF4	380X34	2-PIECE	-12	209	134	
YUKON XL (1/2 TON)	07-		F	RBK165.01	8	FC8	405X36	2-PIECE	31	228	138	F
			F	RBK165.02	12	FC12	405X36	2-PIECE	32	228	151	
			R	RBK166.01	4	FC4	355X32	2-PIECE	-14	199	125	
			R	RBK166.02	4	FF4	380X34	2-PIECE	-12	209	134	
YUKON XL (3/4 TON) W/ 4.63" REAR HUB HOLE	00-02		F	RBK045.01	8	FC8	405X36	2-PIECE	5	228	138	
			F	RBK045.02	12	FC12	405X36	2-PIECE	5	228	151	
			R	RBK077.02	4	FF4	380X34	2-PIECE	-3	209	134	
YUKON XL (3/4 TON) W/ 4.83" REAR HUB HOLE	00-02		F	RBK045.01	8	FC8	405X36	2-PIECE	5	228	138	
			F	RBK045.02	12	FC12	405X36	2-PIECE	5	228	151	
			R	RBK077.03	4	FF4	380X34	2-PIECE	-7	209	134	
YUKON XL (3/4 TON) 2 WHEEL STEERING W/ 4.63" REAR HUB HOLE	03-06		F	RBK045.01	8	FC8	405X36	2-PIECE	5	228	138	
			F	RBK045.02	12	FC12	405X36	2-PIECE	5	228	151	
			R	RBK077.02	4	FF4	380X34	2-PIECE	-3	209	134	
YUKON XL (3/4 TON) 2 WHEEL STEERING W/ 4.83" REAR HUB HOLE	03-06		F	RBK045.01	8	FC8	405X36	2-PIECE	5	228	138	
			F	RBK045.02	12	FC12	405X36	2-PIECE	5	228	151	
			R	RBK077.03	4	FF4	380X34	2-PIECE	-7	209	134	
YUKON XL (3/4 TON) 4 WHEEL STEERING	03-05		F	RBK045.01	8	FC8	405X36	2-PIECE	5	228	138	
			F	RBK045.02	12	FC12	405X36	2-PIECE	5	228	151	
			R									
YUKON XL (3/4 TON)	07		F	RBK045.01	8	FC8	405X36	2-PIECE	5	228	138	
			F	RBK045.02	12	FC12	405X36	2-PIECE	5	228	151	

# BRAKE SYSTEM

MAKE/MODEL	YEAR	CHASSIS	AXLE	PART #	CALIPER		DISC		WHEEL CHART			NOTES
			F/R		PISTON	TYPE	SIZE(MM)	TYPE	A (MM)	B (MM)	C (MM)	
			R	RBK077.02	4	FF4	380X34	2-PIECE	-3	209	134	
<b>HONDA</b>												
ACCORD (4 CYL., V6)	98-02	CG1-3	F	RBK003.01	4	FC4	330X23	1-PIECE	23	187	113	
			F	RBK003.02	4	FC4	330X30	2-PIECE	32	187	113	
			F	RBK003.03	4	FF4	355X32	2-PIECE	37	199	121	
			R									
ACCORD (4 CYL., V6)	03-07	CM5-8	F	RBK003.04	4	FC4	330X23	1-PIECE	23	187	113	
			F	RBK003.05	4	FC4	330X30	2-PIECE	32	187	113	
			F	RBK003.06	4	FF4	355X32	2-PIECE	37	199	121	
			R									
ACCORD WAGON JAPAN MODEL	98-02	CH9	F	RBK006.01	4	FC4-A	295X23	1-PIECE	25	174	96	
			F	RBK006.03	4	FC4	330X30	2-PIECE	32	187	113	
			R									
CIVIC CRX (DX, HF, Si)	88-91	ED8/9	F	RBK005.01	4	FC4	295X21	1-PIECE	25	174	96	
			R									
CIVIC DEL SOL (EXC V-TEC)	93-97	EG1	F	RBK005.01	4	FC4	295X21	1-PIECE	25	174	96	
			R									
CIVIC DEL SOL (V-TEC)	93-97	EJ6-EJ8	F	RBK007.02	4	FC4	330X21	1-PIECE	25	187	113	
			R									
CIVIC DX	90-95	ED8/9, EH2/3 EG6	F	RBK005.01	4	FC4	295X21	1-PIECE	25	174	96	
			R									
CIVIC DX	96-00	EM1, EJ6-8	F	RBK005.02	4	FC4	295X21	1-PIECE	25	174	96	
			R									
CIVIC DX	01-05	EM2, ES1	F	RBK008.01	4	FC4	330X21	1-PIECE	25	187	113	
			R									
CIVIC DX (2.0L)	06-07		F	RBK143.01	4	FC4	330X23	1-PIECE	23	187	113	
			F	RBK143.02	4	FC4	330X30	2-PIECE	32	187	113	
			R									
CIVIC EX (W/ REAR DISC, ABS)	93-95	EH2/3	F	RBK004.01	4	FC4	330X21	1-PIECE	25	187	113	
			R									
CIVIC EX	96-00	EM1, EJ6-8	F	RBK007.01	4	FC4	330X21	1-PIECE	25	187	113	
			R									
CIVIC EX	01-05	EM2, ES1	F	RBK007.02	4	FC4	330X21	1-PIECE	25	187	113	
			R									
CIVIC EX (2.0L)	06-07		F	RBK143.01	4	FC4	330X23	1-PIECE	23	187	113	
			F	RBK143.02	4	FC4	330X30	2-PIECE	32	187	113	
			R									
CIVIC GX	97-00	EM1, EJ6-8	F	RBK005.02	4	FC4	295X21	1-PIECE	25	174	96	
			R									
CIVIC GX	01-05	EM2, ES1	F	RBK007.02	4	FC4	330X21	1-PIECE	25	187	113	
			R									
CIVIC HX	96-00	EM1, EJ6-8	F	RBK005.02	4	FC4	295X21	1-PIECE	25	174	96	
			R									
CIVIC HX	01-05	EM2, ES1	F	RBK008.01	4	FC4	330X21	1-PIECE	25	187	113	
			R									
CIVIC LX	90-95	ED8/9, EH2/3 EG6	F	RBK005.01	4	FC4	295X21	1-PIECE	25	174	96	
			R									
CIVIC LX (REAR DISC W/ ABS)	94-95	EH2/3	F	RBK004.01	4	FC4	330X21	1-PIECE	25	187	113	
			R									
CIVIC LX	96-00	EM1, EJ6-8	F	RBK005.02	4	FC4	295X21	1-PIECE	25	174	96	
			R									
CIVIC LX	01-03	EM2, ES1	F	RBK008.01	4	FC4	330X21	1-PIECE	25	187	113	
			R									
CIVIC LX	04-05	EM2, ES1	F	RBK007.02	4	FC4	330X21	1-PIECE	25	187	113	
			R									
CIVIC LX (2.0L)	06-07	FG1	F	RBK143.01	4	FC4	330X23	1-PIECE	23	187	113	
			F	RBK143.02	4	FC4	330X30	2-PIECE	32	187	113	
			R									
CIVIC Si	99-00	EM1, EJ6-8	F	RBK007.01	4	FC4	330X21	1-PIECE	25	187	113	
			R									
CIVIC Si (2.0L)	06-07	FG2	F	RBK143.01	4	FC4	330X23	1-PIECE	23	187	113	
			F	RBK143.02	4	FC4	330X30	2-PIECE	32	187	113	
			F	RBK143.03	4	FF4	355X32	2-PIECE	37	199	121	
			R									
CIVIC HATCHBACK	88-95	EG6	F	RBK005.01	4	FC4	295X21	1-PIECE	25	174	96	
			R									
CIVIC HATCHBACK (1600 Si W/ ABS ONLY)	94-95	EH2/3	F	RBK004.01	4	FC4	330X21	1-PIECE	25	187	113	

# BRAKE SYSTEM

MAKE/MODEL	YEAR	CHASSIS	AXLE	PART #	CALIPER		DISC		WHEEL CHART			NOTES
			F/R		PISTON	TYPE	SIZE(MM)	TYPE	A (MM)	B (MM)	C (MM)	
CIVIC HATCHBACK	96-00	EG6	R	RBK005.02	4	FC4	295X21	1-PIECE	25	174	96	
			F									
CIVIC HATCHBACK SI	02-03	EP3	F	RBK007.02	4	FC4	330X21	1-PIECE	25	187	113	
			R									
CIVIC HATCHBACK SI	04-05	EP3	F	RBK001.01	4	FC4	330X25	1-PIECE	22	187	113	
			F	RBK001.02	4	FC4	330X30	2-PIECE	27	187	113	
			F	RBK001.03	4	FF4	355X32	2-PIECE	30	199	121	
			R	RBK138.01	2	FC2	330X30	2-PIECE	36	189	112	
CIVIC TYPE R JAPAN MODEL	10/01-04	EP3	F	RBK001.01	4	FC4	330X25	1-PIECE	22	187	113	
			F	RBK001.02	4	FC4	330X30	2-PIECE	27	187	113	
			F	RBK001.03	4	FF4	355X32	2-PIECE	30	199	121	
			F	RBK001.04	6	FC6	330X30	2-PIECE	42	191	108	
CR-V	97-01	RD1-5	F	RBK006.02	4	FC4-A	295X23	1-PIECE	25	174	96	
			R	RBK006.04	4	FC4	330X30	2-PIECE	32	187	113	
CR-V	02-06	RD6-7	F	RBK001.01	4	FC4	330X25	1-PIECE	22	187	113	
			F	RBK001.02	4	FC4	330X30	2-PIECE	27	187	113	
			F	RBK001.03	4	FF4	355X32	2-PIECE	30	199	121	
			R	RBK140.05	2	FC2	330X30	2-PIECE	22	189	112	
CR-V	07	RE-3/4	F	RBK221.01	6	FC6	355X32	2-PIECE	45	201	122	C
			R									
ELEMENT	03-07	YH1/2	F	RBK001.01	4	FC4	330X25	1-PIECE	22	187	113	
			F	RBK001.02	4	FC4	330X30	2-PIECE	27	187	113	
			F	RBK001.03	4	FF4	355X32	2-PIECE	30	199	121	
			R	RBK140.05	2	FC2	330X30	2-PIECE	22	189	112	
FIT USA, JAPAN MODEL	01-07	GD1-4	F	RBK173.01	4	FC4	330X21	1-PIECE	25	187	113	
			R									
INTEGRA TYPE R JAPAN MODEL	6/01-06	DC5	F	RBK154.01	4	FC4	330X30	2-PIECE	17	187	113	
			F	RBK154.02	4	FF4	355X32	2-PIECE	20	199	121	
			F	RBK154.03	6	FC6	330X30	2-PIECE	32	191	108	
			R	RBK138.02	2	FC2	330X30	2-PIECE	21	189	112	
ODYSSEY JAPAN MODEL	10/94-1/00	RA1-5	F	RBK006.01	4	FC4-A	295X23	1-PIECE	25	174	96	
			R	RBK006.03	4	FC4	330X30	2-PIECE	32	187	113	
ODYSSEY	95-98	RA1-5	F	RBK006.01	4	FC4-A	295X23	1-PIECE	25	174	96	
			R	RBK006.03	4	FC4	330X30	2-PIECE	32	187	113	
ODYSSEY JAPAN MODEL	1/00-10/03	RA6-9	F	RBK006.01	4	FC4-A	295X23	1-PIECE	25	174	96	
			R	RBK006.03	4	FC4	330X30	2-PIECE	32	187	113	
ODYSSEY	99-04	RA6-9	F	RBK003.02	4	FC4	330X30	2-PIECE	32	187	113	
			R	RBK003.03	4	FF4	355X32	2-PIECE	37	199	121	
ODYSSEY	05-07	RB1/2	F	RBK221.01	6	FC6	355X32	2-PIECE	45	201	122	C
PILOT	03-07	YF18	F	RBK003.10	6	FC6	355X32	2-PIECE	45	201	122	
PRELUDE (ALL MODEL)	97-01	BB5/6/7	F	RBK006.02	4	FC4-A	295X23	1-PIECE	25	174	96	
			R	RBK006.04	4	FC4	330X30	2-PIECE	32	187	113	
RIDGELINE	06-07	YK16	F	RBK215.01	6	FC6	355X32	2-PIECE	45	201	122	C
STEP WAGN JAPAN MODEL	96-01	RF1/2	F	RBK006.01	4	FC4-A	295X23	1-PIECE	25	174	96	
			R	RBK006.03	4	FC4	330X30	2-PIECE	32	187	113	
S2000	00-07	AP1/2	F	RBK035.01	4	FC4	330X30	2-PIECE	34	187	113	
			F	RBK035.02	4	FF4	355X32	2-PIECE	37	199	121	
			F	RBK035.03	6	FC6	330X30	2-PIECE	50	191	108	
			R	RBK223.01	2	FC2	330X30	2-PIECE	45	189	112	
<b>HUMMER</b>												
H2	03-07		F	RBK045.01	8	FC8	405X36	2-PIECE	5	228	138	
			F	RBK045.02	12	FC12	405X36	2-PIECE	6	228	151	
			R	RBK077.01	4	FF4	380X34	2-PIECE	-3	209	134	

# BRAKE SYSTEM

MAKE/MODEL	YEAR	CHASSIS	AXLE		PART #	CALIPER		DISC		WHEEL CHART			NOTES
			F/R			PISTON	TYPE	SIZE(MM)	TYPE	A (MM)	B (MM)	C (MM)	
H3	06-07		F		RBK119.01	8	FC8	405X36	2-PIECE	24	228	138	G
			R		RBK120.01	4	FF4	380X34	2-PIECE	17	209	134	
<b>HYUNDAI</b>													
ELANTRA	8/98-00	RD	F		RBK012.03	4	FC4	330X30	1-PIECE	33	191	108	
			R		RBK012.04	4	FC4	330X30	2-PIECE	33	191	108	
ELANTRA	01-06	XD	F		RBK012.01	4	FC4	330X30	1-PIECE	33	187	113	
			R		RBK012.02	4	FC4	330X30	2-PIECE	33	187	113	
TIBURON	99-01	RC	F		RBK012.03	4	FC4	330X30	1-PIECE	33	187	113	
			R		RBK012.04	4	FC4	330X30	2-PIECE	33	187	113	
TIBURON	03-07	GK	F		RBK012.01	4	FC4	330X30	1-PIECE	33	187	113	
			R		RBK012.02	4	FC4	330X30	2-PIECE	33	187	113	
<b>INFINITI</b>													
FX35, FX45	03-07	T/PZ50	F		RBK073.01	6	FC6	355X32	2-PIECE	42	201	122	A
			F		RBK073.02	8	FC8	380X34	2-PIECE	44	217	126	
			F		RBK073.06	12	FC12	380X34	2-PIECE	45	220	138	
			R		RBK074.01	4	FC4-A	355X32	2-PIECE	19	199	125	
G20 (PRIMERA)	91-02	P10/11	F		RBK063.01	4	FC4	330X30	2-PIECE	30	187	113	
G35 (ALL MODEL)	02-06	V/NV/HV35 CPV35	F		RBK015.01	4	FC4	330X30	2-PIECE	30	187	113	
			F		RBK015.02	6	FC6	355X32	2-PIECE	42	201	122	
			F		RBK015.03	8	FC8	380X34	2-PIECE	44	217	126	
			R		RBK029.01	4	FC4-A	330X30	2-PIECE	32	187	113	
			R		RBK029.02	4	FC4-A	355X32	2-PIECE	20	199	125	
G35, G37 (ALL MODEL)	07-08	V36	F		RBK073.03	6	FC6	355X32	2-PIECE	42	201	122	
			F		RBK073.04	8	FC8	380X34	2-PIECE	44	217	126	
			R		RBK029.02	4	FC4-A	355X32	2-PIECE	20	199	125	
			R		RBK029.03	4	FF4	380X34	2-PIECE	22	209	134	
			F		RBK063.01	4	FC4	330X30	2-PIECE	30	187	113	
I30 (CEFIRO)	95-99	A32	F		RBK063.01	4	FC4	330X30	2-PIECE	30	187	113	
I30, I35 (CEFIRO)	00-04	A33	F		RBK158.01	4	FC4	330X30	2-PIECE	30	187	113	
M45 (GLORIA, CEDRIC)	03-05	Y34	F		RBK192.01	6	FC6	355X32	2-PIECE	42	201	122	
			R		RBK172.01	4	FC4-A	355X32	2-PIECE	18	199	125	
M35, M45 (FUGA)	06-07	GY50	F		RBK073.05	4	FC4	330X30	2-PIECE	30	187	113	
			F		RBK073.03	6	FC6	355X32	2-PIECE	42	201	122	
			F		RBK073.04	8	FC8	380X34	2-PIECE	44	217	126	
			R		RBK029.01	4	FC4-A	330X30	2-PIECE	32	187	113	
			R		RBK029.02	4	FC4-A	355X32	2-PIECE	20	199	125	
QX56	04-07	JA60	F		RBK075.01	8	FC8	405X36	2-PIECE	51	228	138	
			R										
Q45 (CIMA)	90-96	G50	F		RBK017.04	4	FC4	330X30	2-PIECE	30	187	113	
			R		RBK017.05	6	FC6	355X32	2-PIECE	42	201	122	
Q45 (CIMA)	97-01	Y33	F		RBK171.01	6	FC6	355X32	2-PIECE	43	201	122	
			R		RBK172.01	4	FC4-A	355X32	2-PIECE	18	199	125	
Q45 (CIMA)	02-07	F50	F		RBK192.01	6	FC6	355X32	2-PIECE	36	201	122	
			F		RBK192.02	8	FC8	380X34	2-PIECE	38	217	126	
			R		RBK172.01	4	FC4-A	355X32	2-PIECE	18	199	125	
<b>ISUZU</b>													
ASCENDER	03-07		F		RBK091.01	6	FC6	355X32	2-PIECE	37	201	122	G
			F		RBK091.02	8	FC8	380X34	2-PIECE	39	217	126	
			R		RBK092.01	4	FF4	380X34	2-PIECE	-2	209	134	
<b>JAGUAR</b>													
S TYPE R	03-05		F		RBK130.01	12	FC12	380X34	2-PIECE	18	220	138	A
			R		RBK131.01	4	FF4	380X34	2-PIECE	42	209	134	
XJR	04-05		F		RBK130.01	12	FC12	380X34	2-PIECE	18	220	138	A
			R		RBK131.01	4	FF4	380X34	2-PIECE	42	209	134	

# BRAKE SYSTEM

MAKE/MODEL	YEAR	CHASSIS	AXLE	PART #	CALIPER		DISC		WHEEL CHART			NOTES
					PISTON	TYPE	SIZE(MM)	TYPE	A (MM)	B (MM)	C (MM)	
<b>JEEP</b>												
WAGONEER	81-91		F	RBK132.01	8	FC8	405X36	2-PIECE	-	-	-	A
			R									
COMPASS	07		F	RBK220.01	4	FC4	330X24	1-PIECE	28	187	113	C
			F	RBK220.02	4	FC4	330X30	2-PIECE	34	187	113	C
			F	RBK220.03	4	FF4	355X32	2-PIECE	37	199	121	C
			F	RBK220.04	6	FC6	355X32	2-PIECE	46	201	122	C
			R									
PATRIOT	07		F	RBK220.01	4	FC4	330X24	1-PIECE	28	187	113	C
			F	RBK220.02	4	FC4	330X30	2-PIECE	34	187	113	C
			F	RBK220.03	4	FF4	355X32	2-PIECE	37	199	121	C
			F	RBK220.04	6	FC6	355X32	2-PIECE	46	201	122	C
			R									
<b>LAND ROVER</b>												
LR3	05-07		F	RBK135.01	8	FC8	380X34	2-PIECE	31	217	126	
			F	RBK135.02	12	FC12	405X36	2-PIECE	33	228	151	
			R	RBK136.01	4	FF4	380X34	2-PIECE	24	209	134	
RANGE ROVER	03-07		F	RBK133.01	8	FC8	380X34	2-PIECE	12	217	126	
			F	RBK133.02	12	FC12	405X36	2-PIECE	14	228	151	
			R	RBK134.01	4	FF4	380X34	2-PIECE	8	209	134	
RANGE ROVER SPORT	06-07		F	RBK135.01	8	FC8	380X34	2-PIECE	31	217	126	
			F	RBK135.02	12	FC12	405X36	2-PIECE	33	228	151	
			R	RBK136.01	4	FF4	380X34	2-PIECE	24	209	134	
<b>LEXUS</b>												
ES 300, ES 330 (WINDOM)	92-01	MCV20 VCV10	F	RBK062.01	4	FC4	330X30	2-PIECE	30	187	113	
			R									
ES 300, ES 330 (WINDOM)	02-06	MCV30/31	F	RBK062.01	4	FC4	330X30	2-PIECE	30	187	113	
			F	RBK084.01	6	FC6	355X32	2-PIECE	44	201	122	
			R	RBK139.01	2	FC2	330X30	2-PIECE	19	189	112	F
			R	RBK139.02	4	FC4	330X30	2-PIECE	14	187	113	F
ES 350	07	GSV40	F	RBK062.01	4	FC4	330X30	2-PIECE	30	187	113	
			F	RBK084.01	6	FC6	355X32	2-PIECE	44	201	122	
			R	RBK139.05	4	FC4	330X30	2-PIECE	13	187	113	
GS 300, GS 400, GS 430 (ARISTO)	91-97	JZS147	F	RBK024.01	4	FC4	330X32	1-PIECE	30	187	113	
			F	RBK024.02	4	FC4	330X30	2-PIECE	28	187	113	
			F	RBK024.03	4	FF4	355X32	2-PIECE	31	199	121	
			F	RBK024.04	6	FC6	355X32	2-PIECE	41	201	122	
			R	RBK028.01	4	FC4	355X32	2-PIECE	14	199	125	
GS 300, GS 400, GS 430 (ARISTO)	98-05	JZS160 UZS160/161	F	RBK024.01	4	FC4	330X32	1-PIECE	30	187	113	
			F	RBK024.02	4	FC4	330X30	2-PIECE	28	187	113	
			F	RBK024.03	4	FF4	355X32	2-PIECE	31	199	121	
			F	RBK024.04	6	FC6	355X32	2-PIECE	41	201	122	
			F	RBK024.05	8	FC8	380X34	2-PIECE	47	217	126	
			R	RBK027.01	4	FC4	330X30	2-PIECE	16	187	113	
			R	RBK027.02	4	FC4	355X32	2-PIECE	18	199	125	
GS 300, GS 350, GS 430, GS 450H	06-07	GRS190-195 UZS190 GWS191	F	RBK163.01	4	FF4	355X32	2-PIECE	31	199	121	
			F	RBK163.02	6	FC6	355X32	2-PIECE	40	201	122	
			F	RBK163.03	8	FC8	380X34	2-PIECE	47	217	126	
			R	RBK164.01	4	FC4	355X32	2-PIECE	12	199	125	
GX 470 (LANDCRUISER PRADO)	03-07	UZJ120	F	RBK082.01	6	FC6	355X32	2-PIECE	21	201	122	
			R	RBK059.01	4	FC4	355X32	2-PIECE	13	199	125	
IS 200, IS 300 (ALTEZZA)	00-05	JCE10/10W SXE10/GXE10	F	RBK013.01	4	FC4	330X32	1-PIECE	30	187	113	
			F	RBK013.02	4	FC4	330X30	2-PIECE	28	187	113	
			F	RBK013.03	6	FC6	355X32	2-PIECE	41	201	122	
			R	RBK027.03	4	FC4	330X30	2-PIECE	16	187	113	
			R	RBK027.04	4	FC4	355X32	2-PIECE	18	199	125	
IS 220d, IS 250	06-07	GSE20/25	F	RBK174.01	4	FF4	355X32	2-PIECE	33	199	121	C
			F	RBK174.02	6	FC6	355X32	2-PIECE	42	201	122	C
			R	RBK175.01	4	FC4	355X32	2-PIECE	12	199	125	C
IS 350	06-07	GSE21	F	RBK163.01	4	FF4	355X32	2-PIECE	31	199	121	
			F	RBK163.02	6	FC6	355X32	2-PIECE	40	201	122	
			F	RBK163.03	8	FC8	380X34	2-PIECE	47	217	126	
			R	RBK164.01	4	FC4	355X32	2-PIECE	12	199	125	
LS 400 (CELSIOR)	93-00	UCF10/11 UCF20/21	F	RBK024.01	4	FC4	330X32	1-PIECE	30	187	113	
			F	RBK024.02	4	FC4	330X30	2-PIECE	28	187	113	
			F	RBK024.03	4	FF4	355X32	2-PIECE	31	199	121	

# BRAKE SYSTEM

MAKE/MODEL	YEAR	CHASSIS	AXLE		PART #	CALIPER		DISC		WHEEL CHART			NOTES
			F/R			PISTON	TYPE	SIZE(MM)	TYPE	A (MM)	B (MM)	C (MM)	
			F		RBK024.04	6	FC6	355X32	2-PIECE	41	201	122	
			F		RBK024.05	8	FC8	380X34	2-PIECE	47	217	126	
			R		RBK028.02	4	FC4	355X32	2-PIECE	14	199	125	C
LS 430 (CELSIOR)	01-06	UCF30/31	F		RBK078.01	6	FC6	355X32	2-PIECE	55	201	122	
			F		RBK078.02	8	FC8	380X34	2-PIECE	57	217	126	A
			R		RBK079.01	4	FC4	355X32	2-PIECE	14	199	125	
			R		RBK079.02	4	FF4	380X34	2-PIECE	16	209	134	A
LS 460	07-	USF40/41	F		RBK144.01	8	FC8	380X34	2-PIECE	32	217	126	
			F		RBK144.02	12	FC12	405X36	2-PIECE	34	228	151	
			R		RBK145.01	4	FF4	380X34	2-PIECE	20	209	134	
LX 470 (LANDCRUISER CYGNUS)	98-07	UZJ100	F		RBK080.01	6	FC6	355X32	2-PIECE	-	-	-	
			F		RBK080.02	8	FC8	405X36	2-PIECE	-	-	-	A
			R		RBK147.01	8	FC8	405X36	2-PIECE	-9	228	138	A
RX 300 (HARRIER)	98-03	MCU10/15	F		RBK062.01	4	FC4	330X30	2-PIECE	30	187	113	
			F		RBK084.01	6	FC6	355X32	2-PIECE	44	201	122	
			R										
RX 330, RX 350, RX 400H (HARRIER)	04-08	MCU33/38 GSU35: MHU38	F		RBK084.01	6	FC6	355X32	2-PIECE	44	201	122	
			R		RBK085.01	4	FC4-A	330X30	2-PIECE	10	187	113	
SC 300, SC 400 (SOARER)	92-00	JZZ30/31 UZZ31	F		RBK024.06	4	FC4	330X32	1-PIECE	30	187	113	
			F		RBK024.07	4	FC4	330X30	2-PIECE	28	187	113	
			F		RBK024.08	4	FF4	355X32	2-PIECE	31	199	121	
			F		RBK024.09	6	FC6	355X32	2-PIECE	41	201	122	
			F		RBK024.10	8	FC8	380X34	2-PIECE	47	217	126	
			R		RBK028.01	4	FC4	355X32	2-PIECE	14	199	125	
SC 430 (SOARER)	4/01-07	UZZ40	F		RBK024.01	4	FC4	330X32	1-PIECE	30	187	113	
			F		RBK024.02	4	FC4	330X30	2-PIECE	28	187	113	
			F		RBK024.03	4	FF4	355X32	2-PIECE	31	199	121	
			F		RBK024.04	6	FC6	355X32	2-PIECE	41	201	122	
			F		RBK024.05	8	FC8	380X34	2-PIECE	47	217	126	
			R		RBK027.01	4	FC4	330X30	2-PIECE	16	187	113	
			R		RBK027.02	4	FC4	355X32	2-PIECE	18	199	125	
<b>LINCOLN</b>													
MK Z	07		F		RBK043.01	4	FC4	330X30	2-PIECE	31	187	113	
			R										
NAVIGATOR (2WD, 4WD)	3/02-06		F		RBK089.01	8	FC8	405X36	2-PIECE	46	228	138	
			R										
ZEPHYR	06		F		RBK043.01	4	FC4	330X30	2-PIECE	31	187	113	
			R										
<b>LOTUS</b>													
ELISE	05-		F		RBK198.01	4	FC4	330X30	2-PIECE	35	187	113	C
			R										
EXIGE	06-		F		RBK198.01	4	FC4	330X30	2-PIECE	35	187	113	C
			R										
<b>MAZDA</b>													
MAZDASPEED PROTÉGÉ	03	BJFW, BJF9	F		RBK043.02	4	FC4	330X30	2-PIECE	31	187	113	
			R										
MIATA MX-5 (ALL MODEL)	89-05	NA/NB/C, 6CE,	F		RBK023.01	4	FC4	330X30	2-PIECE	34	187	113	
			R										
MAZDASPEED MX-5 (TURBO)	04-05	NB/C	F		RBK023.01	4	FC4	330X30	2-PIECE	34	187	113	
			R										
PROTÉGÉ, PROTÉGÉ 5 (EXC 1.6L)	99-03	BJFP/FW	F		RBK043.02	4	FC4	330X30	2-PIECE	31	187	113	
			R										
RX7 (5 LUG) USA, JAPAN MODEL	86-92	FC3S/3C	F		RBK036.01	4	FC4	330X30	2-PIECE	15	187	113	
			R										
RX7 USA, JAPAN MODEL	93-02	FD3S	F		RBK019.01	4	FC4	330X30	2-PIECE	12	187	113	
			F		RBK019.02	6	FC6	355X32	2-PIECE	25	201	122	
			R		RBK051.01	4	FC4-A	330X30	2-PIECE	34	187	113	B
RX8	04-07	SE3P	F		RBK037.01	6	FC6	355X32	2-PIECE	47	201	122	
			R		RBK150.01	4	FC4	355X32	2-PIECE	38	199	125	B
3, MAZDASPEED 3 (AXELA)	04-07	BK3P	F		RBK069.01	4	FC4	330X30	2-PIECE	33	187	114	
			R										
5 (PREMACY)	06-07	BK3P	F		RBK069.01	4	FC4	330X30	2-PIECE	33	187	114	
			R										
6, MAZDASPEED 6 (ATENZA)	03-07	GG3P	F		RBK043.01	4	FC4	330X30	2-PIECE	31	187	113	
			R										

# BRAKE SYSTEM

MAKE/MODEL	YEAR	CHASSIS	AXLE		PART #	CALIPER		DISC		WHEEL CHART			NOTES
			F/R			PISTON	TYPE	SIZE(MM)	TYPE	A (MM)	B (MM)	C (MM)	
<b>MERCEDES-BENZ</b>													
B CLASS	05-	W245	F		RBK186.01	4	FC4	330X30	2-PIECE	35	187	113	A
C CLASS, AMG	94-00	W202	F		RBK149.01	4	FC4	330X30	2-PIECE	33	187	113	
			F		RBK149.02	6	FC6	355X32	2-PIECE	45	201	122	
			R		RBK098.02	4	FC4	330X30	2-PIECE	25	187	113	
			R		RBK098.01	4	FC4	355X32	2-PIECE	27	199	125	
C CLASS, AMG	01-07	W203	F		RBK097.01	4	FC4	330X30	2-PIECE	33	187	113	
			F		RBK097.02	6	FC6	355X32	2-PIECE	45	201	122	
			R		RBK098.02	4	FC4	330X30	2-PIECE	25	187	113	
			R		RBK098.01	4	FC4	355X32	2-PIECE	27	199	125	
CL CLASS	98-99	W140	F		RBK180.01	6	FC6	355X32	2-PIECE	10	201	122	
			R		RBK181.01	4	FC4	355X32	2-PIECE	26	199	125	
CL CLASS (EXC AMG)	00-06	W215	F		RBK177.01	6	FC6	355X32	2-PIECE	18	201	122	
			F		RBK177.02	8	FC8	380X34	2-PIECE	20	217	126	
			F		RBK177.03	12	FC12	405X36	2-PIECE	21	228	151	
			R		RBK100.01	4	FC4	355X32	2-PIECE	29	199	125	
			R		RBK100.02	4	FF4	380X34	2-PIECE	30	209	134	
CL CLASS (EXC AMG)	07-	W216	F		RBK225.01	8	FC8	380X34	2-PIECE	29	217	126	C
			F		RBK225.02	12	FC12	405X36	2-PIECE	30	228	151	C
			R		RBK179.01	4	FC4	355X32	2-PIECE	29	199	125	
			R		RBK179.02	4	FF4	380X34	2-PIECE	30	209	134	
CL55 AMG	01-02	W215	F		RBK177.01	6	FC6	355X32	2-PIECE	18	201	122	
			F		RBK177.02	8	FC8	380X34	2-PIECE	20	217	126	
			F		RBK177.03	12	FC12	405X36	2-PIECE	21	228	151	
			R		RBK100.01	4	FC4	355X32	2-PIECE	29	199	125	
			R		RBK100.02	4	FF4	380X34	2-PIECE	30	209	134	
CL55 AMG	03-06	W215	F		RBK178.01	8	FC8	380X34	2-PIECE	20	217	126	
			F		RBK178.02	12	FC12	405X36	2-PIECE	21	228	151	
			R		RBK100.01	4	FC4	355X32	2-PIECE	29	199	125	
			R		RBK100.02	4	FF4	380X34	2-PIECE	30	209	134	
CLK CLASS, CLK55 AMG	98-02	W208	F		RBK149.01	4	FC4	330X30	2-PIECE	33	187	113	
			F		RBK149.02	6	FC6	355X32	2-PIECE	45	201	122	
			R		RBK098.02	4	FC4	330X30	2-PIECE	25	187	113	
			R		RBK098.01	4	FC4	355X32	2-PIECE	27	199	125	
CLK CLASS (EXC AMG)	03-07	W209	F		RBK097.01	4	FC4	330X30	2-PIECE	33	187	113	
			F		RBK097.02	6	FC6	355X32	2-PIECE	45	201	122	
			R		RBK098.02	4	FC4	330X30	2-PIECE	25	187	113	
			R		RBK098.01	4	FC4	355X32	2-PIECE	27	199	125	
CLK55 AMG	03-06	W209	F		RBK097.02	6	FC6	355X32	2-PIECE	45	201	122	
R		RBK098.01	4	FC4	355X32	2-PIECE	27	199	125				
CLS CLASS (EXC AMG)	05-07	C219	F		RBK099.01	6	FC6	355X32	2-PIECE	27	201	122	
			F		RBK099.02	8	FC8	380X34	2-PIECE	29	217	126	
			F		RBK099.03	12	FC12	405X36	2-PIECE	30	228	151	
			R		RBK176.01	4	FC4	355X32	2-PIECE	17	199	125	
			R		RBK176.02	4	FF4	380X34	2-PIECE	19	209	134	
CLS55, CLS63 AMG	05-07	C219	F		RBK185.01	8	FC8	380X34	2-PIECE	29	217	126	
			F		RBK185.02	12	FC12	405X36	2-PIECE	30	228	151	
			R		RBK176.01	4	FC4	355X32	2-PIECE	17	199	125	
			R		RBK176.02	4	FF4	380X34	2-PIECE	19	209	134	
E CLASS, AMG	96-02	W210	F		RBK149.01	4	FC4	330X30	2-PIECE	33	187	113	
			F		RBK149.02	6	FC6	355X32	2-PIECE	45	201	122	
			R		RBK098.02	4	FC4	330X30	2-PIECE	25	187	113	
			R		RBK098.01	4	FC4	355X32	2-PIECE	27	199	125	
E CLASS (EXC 4-MATIC, AMG)	03-07	W211	F		RBK099.01	6	FC6	355X32	2-PIECE	27	201	122	
			F		RBK099.02	8	FC8	380X34	2-PIECE	29	217	126	
			F		RBK099.03	12	FC12	405X36	2-PIECE	30	228	151	
			R		RBK176.01	4	FC4	355X32	2-PIECE	17	199	125	
			R		RBK176.02	4	FF4	380X34	2-PIECE	19	209	134	
E55, E63 AMG	03-07	W211	F		RBK185.01	8	FC8	380X34	2-PIECE	29	217	126	
			F		RBK185.02	12	FC12	405X36	2-PIECE	30	228	151	
			R		RBK176.01	4	FC4	355X32	2-PIECE	17	199	125	
			R		RBK176.02	4	FF4	380X34	2-PIECE	19	209	134	
G500, G55 AMG	02-05	W463	F		RBK121.01	12	FC12	405X36	2-PIECE	11	228	151	C
			R		RBK122.01	4	FF4	380X34	2-PIECE	-14	209	134	C
ML430, ML500, ML55 AMG	00-05	W163	F		RBK182.01	6	FC6	355X32	2-PIECE	42	201	122	
			F		RBK182.02	8	FC8	380X34	2-PIECE	42	217	126	

# BRAKE SYSTEM

MAKE/MODEL	YEAR	CHASSIS	AXLE	PART #	CALIPER		DISC		WHEEL CHART			NOTES
			F/R		PISTON	TYPE	SIZE(MM)	TYPE	A (MM)	B (MM)	C (MM)	
S CLASS	92-99	W140	R	RBK183.01	4	FC4	355X32	2-PIECE	37	199	125	
			F	RBK180.01	6	FC6	355X32	2-PIECE	10	201	122	
S CLASS (EXC 4-MATIC, AMG)	00-06	W220	R	RBK181.01	4	FC4	355X32	2-PIECE	26	199	125	
			F	RBK177.01	6	FC6	355X32	2-PIECE	18	201	122	
			F	RBK177.02	8	FC8	380X34	2-PIECE	20	217	126	
			F	RBK177.03	12	FC12	405X36	2-PIECE	21	228	151	
			R	RBK100.01	4	FC4	355X32	2-PIECE	29	199	125	
S550 (EXC 4-MATIC)	07-	W221	R	RBK100.02	4	FF4	380X34	2-PIECE	30	209	134	
			F	RBK225.01	8	FC8	380X34	2-PIECE	29	217	126	C
			F	RBK225.02	12	FC12	405X36	2-PIECE	30	228	151	C
			R	RBK179.01	4	FC4	355X32	2-PIECE	29	199	125	
S55 AMG	01-02	W220	R	RBK179.02	4	FF4	380X34	2-PIECE	30	209	134	
			F	RBK177.01	6	FC6	355X32	2-PIECE	18	201	122	
			F	RBK177.02	8	FC8	380X34	2-PIECE	20	217	126	
			F	RBK177.03	12	FC12	405X36	2-PIECE	21	228	151	
			R	RBK100.01	4	FC4	355X32	2-PIECE	29	199	125	
S55 AMG	03-06	W220	R	RBK100.02	4	FF4	380X34	2-PIECE	30	209	134	
			F	RBK178.01	8	FC8	380X34	2-PIECE	20	217	126	
			F	RBK178.02	12	FC12	405X36	2-PIECE	21	228	151	
			R	RBK100.01	4	FC4	355X32	2-PIECE	29	199	125	
SL CLASS	90-02	R129	R	RBK100.02	4	FF4	380X34	2-PIECE	30	209	134	
			F	RBK184.01	4	FC4	330X30	2-PIECE	34	187	113	
			F	RBK184.02	6	FC6	355X32	2-PIECE	47	201	122	
			R	RBK098.02	4	FC4	330X30	2-PIECE	25	187	113	
SL CLASS (EXC AMG)	03-07	R230	R	RBK098.01	4	FC4	355X32	2-PIECE	27	199	125	
			F	RBK099.01	6	FC6	355X32	2-PIECE	27	201	122	
			F	RBK099.02	8	FC8	380X34	2-PIECE	29	217	126	
			F	RBK099.03	12	FC12	405X36	2-PIECE	30	228	151	
SL55 AMG	03-06	R230	R	RBK179.01	4	FC4	355X32	2-PIECE	29	199	125	
			F	RBK185.01	8	FC8	380X34	2-PIECE	29	217	126	
			F	RBK185.02	12	FC12	405X36	2-PIECE	30	228	151	
			R	RBK179.02	4	FF4	380X34	2-PIECE	30	209	134	
SLK CLASS (EXC AMG)	97-04	R170	R	RBK179.02	4	FF4	380X34	2-PIECE	30	209	134	
			F	RBK149.01	4	FC4	330X30	2-PIECE	33	187	113	
			F	RBK149.02	6	FC6	355X32	2-PIECE	45	201	122	
			R	RBK098.02	4	FC4	330X30	2-PIECE	25	187	113	
SLK CLASS (EXC AMG)	05-07	R171	R	RBK098.01	4	FC4	355X32	2-PIECE	27	199	125	
			F	RBK097.01	4	FC4	330X30	2-PIECE	33	187	113	
			F	RBK097.02	6	FC6	355X32	2-PIECE	45	201	122	
			R	RBK098.02	4	FC4	330X30	2-PIECE	25	187	113	
SLK55 AMG	05	R171	R	RBK098.01	4	FC4	355X32	2-PIECE	27	199	125	
			F	RBK097.02	6	FC6	355X32	2-PIECE	45	201	122	
190, 260, 300 CLASS	84-93	C/T/W124	F	RBK184.01	4	FC4	330X30	2-PIECE	34	187	113	
		W201	R	RBK098.02	4	FC4	330X30	2-PIECE	25	187	113	
<b>MERCURY</b>												
COUGAR	93-97		F	RBK020.03	4	FC4	330X28	1-PIECE	33	187	113	
			F	RBK020.04	6	FC6	355X32	2-PIECE	48	201	122	
MILAN	06-07		R									
			F	RBK043.01	4	FC4	330X30	2-PIECE	31	187	113	
<b>MINI</b>												
COOPER, COOPER-S	02-06	RA/RE16	F	RBK055.01	4	FC4	330X30	2-PIECE	35	187	113	
			R									
<b>MITSUBISHI</b>												
DIAMANTE	92-96	F16A/16, F07	F	RBK002.01	4	FC4	330X24	1-PIECE	28	187	113	
			F	RBK002.04	4	FC4	330X30	2-PIECE	34	187	113	
			R									
DIAMANTE	97-04	F38A	F	RBK018.01	4	FC4	330X24	1-PIECE	28	187	113	
			F	RBK018.02	4	FC4	330X30	2-PIECE	34	187	113	
			R									
ECLIPSE (2WD, 4WD)	4/89-93	D21A, D22A, D27A	F	RBK002.01	4	FC4	330X24	1-PIECE	28	187	113	
			F	RBK002.04	4	FC4	330X30	2-PIECE	34	187	113	
			F	RBK002.07	4	FF4	355X32	2-PIECE	37	199	121	



# BRAKE SYSTEM

MAKE/MODEL	YEAR	CHASSIS	AXLE	PART #	CALIPER		DISC		WHEEL CHART			NOTES
					PISTON	TYPE	SIZE(MM)	TYPE	A (MM)	B (MM)	C (MM)	
			F	RBK002.10	6	FC6	355X32	2-PIECE	46	201	122	
ECLIPSE (2WD, 4WD)	94-99	D31A/32A, D33A/38A	F	RBK002.02	4	FC4	330X24	1-PIECE	28	187	113	
			F	RBK002.05	4	FC4	330X30	2-PIECE	34	187	113	
			F	RBK002.08	4	FF4	355X32	2-PIECE	37	199	121	
			F	RBK002.11	6	FC6	355X32	2-PIECE	46	201	122	
			R	RBK141.01	2	FC2	330X30	2-PIECE	24	189	112	F
			R	RBK141.02	4	FC4	330X30	2-PIECE	19	187	113	F
ECLIPSE (4 CYL., V6)	00-05	D53A	F	RBK018.01	4	FC4	330X24	1-PIECE	28	187	113	
			F	RBK018.02	4	FC4	330X30	2-PIECE	34	187	113	
			F	RBK018.03	4	FF4	355X32	2-PIECE	37	199	121	
			F	RBK030.02	6	FC6	355X32	2-PIECE	46	201	122	
			R	RBK141.01	2	FC2	330X30	2-PIECE	24	189	112	F
			R	RBK141.02	4	FC4	330X30	2-PIECE	19	187	113	F
ECLIPSE (4 CYL., V6)	06-07	DK4A	F	RBK018.04	4	FC4	330X24	1-PIECE	28	187	113	
			F	RBK018.05	4	FC4	330X30	2-PIECE	34	187	113	
			F	RBK018.06	4	FF4	355X32	2-PIECE	37	199	121	
			F	RBK030.01	6	FC6	355X32	2-PIECE	46	201	122	
			R	RBK129.01	2	FC2	330X30	2-PIECE	24	189	112	
			R	RBK129.02	4	FC4	330X30	2-PIECE	19	187	113	
GALANT	89-1/93	E18A/33A, E38A/39A	F	RBK002.01	4	FC4	330X24	1-PIECE	28	187	113	
			F	RBK002.04	4	FC4	330X30	2-PIECE	34	187	113	
GALANT	2/93-1/98	E56A	F	RBK002.02	4	FC4	330X24	1-PIECE	28	187	113	
			F	RBK002.05	4	FC4	330X30	2-PIECE	34	187	113	
			R	RBK141.01	2	FC2	330X30	2-PIECE	24	189	112	F
			R	RBK141.02	4	FC4	330X30	2-PIECE	19	187	113	F
GALANT (4 CYL., V6)	2/98-03	EA3A/A8A	F	RBK018.01	4	FC4	330X24	1-PIECE	28	187	113	
			F	RBK018.02	4	FC4	330X30	2-PIECE	34	187	113	
			R	RBK141.01	2	FC2	330X30	2-PIECE	24	189	112	F
			R	RBK141.02	4	FC4	330X30	2-PIECE	19	187	113	F
GALANT (4 CYL., V6)	04-07	DJ1A/3A	F	RBK018.04	4	FC4	330X24	1-PIECE	28	187	113	
			F	RBK018.05	4	FC4	330X30	2-PIECE	34	187	113	
			F	RBK018.06	4	FF4	355X32	2-PIECE	37	199	121	
			F	RBK030.01	6	FC6	355X32	2-PIECE	46	201	122	
			R	RBK129.01	2	FC2	330X30	2-PIECE	24	189	112	
			R	RBK129.02	4	FC4	330X30	2-PIECE	19	187	113	
LANCER EVOLUTION (IV, V, VI, VII, VIII, IX)	97-06	CN/CP/CT9A	F	RBK030.03	6	FC6	330X30	2-PIECE	44	191	108	
			F	RBK030.01	6	FC6	355X32	2-PIECE	46	201	122	
			R	RBK031.01	4	FC4	330X30	2-PIECE	22	187	113	
LANCER LS	02-05	CS6A	F	RBK034.01	4	FM4	282X25	2-PIECE	29	163	89	
LANCER RALLIART (2.4L)	04-06	CS7A	F	RBK002.03	4	FC4	330X24	1-PIECE	28	187	113	
			F	RBK002.06	4	FC4	330X30	2-PIECE	34	187	113	
			F	RBK002.09	4	FF4	355X32	2-PIECE	37	199	121	
			R									
O-Z RALLY EDITION	02-06	CS6A	F	RBK034.01	4	FM4	282X25	2-PIECE	29	163	89	
3000 GT GT-SL	90-99	Z11A	F	RBK002.01	4	FC4	330X24	1-PIECE	28	187	113	
			F	RBK002.04	4	FC4	330X30	2-PIECE	34	187	113	
			F	RBK002.07	4	FF4	355X32	2-PIECE	37	199	121	
			F	RBK002.10	6	FC6	355X32	2-PIECE	46	201	122	
			R									
3000 GT-VR4	4/90-99	Z15/16A	F	RBK060.01	6	FC6	355X32	2-PIECE	46	201	122	
			R	RBK157.02	4	FC4	355X32	2-PIECE	29	199	125	
<b>NISSAN</b>												
ALTIMA	93-01	L30	F	RBK063.01	4	FC4	330X30	2-PIECE	30	187	113	
ALTIMA	02-06	L31	F	RBK158.01	4	FC4	330X30	2-PIECE	30	187	113	
			F	RBK158.02	6	FC6	355X32	2-PIECE	44	201	122	
			R	RBK029.01	4	FC4-A	330X30	2-PIECE	32	187	113	
			R	RBK029.02	4	FC4-A	355X32	2-PIECE	20	199	125	
ARMADA	04-07	TA60	F	RBK075.01	8	FC8	405X36	2-PIECE	51	228	138	
AVENIR SALUT JAPAN MODEL	8/95-8/98	PNW10	F	RBK017.01	4	FC4	330X30	2-PIECE	30	187	113	
			F	RBK017.02	6	FC6	355X32	2-PIECE	42	201	122	
			R									

# BRAKE SYSTEM

MAKE/MODEL	YEAR	CHASSIS	AXLE	PART #	CALIPER		DISC		WHEEL CHART			NOTES
					PISTON	TYPE	SIZE(MM)	TYPE	A (MM)	B (MM)	C (MM)	
ELGRAND JAPAN MODEL	02-	NE/E51	F	RBK190.01	4	FC4	330X30	2-PIECE	30	187	113	
			F	RBK190.02	6	FC6	355X32	2-PIECE	44	201	122	
			R									
FRONTIER (2WD, 4WD)	05-07	D40	F	RBK216.01	6	FC6	355X32	2-PIECE	55	201	122	C
			R	RBK217.01	4	FC4	355X32	2-PIECE	21	199	125	C
MAXIMA	8/89-3/99	A32	F	RBK063.01	4	FC4	330X30	2-PIECE	30	187	113	
MAXIMA	4/99-03	A33	F	RBK158.01	4	FC4	330X30	2-PIECE	30	187	113	
			R									
MAXIMA	04-07	A34	F	RBK158.01	4	FC4	330X30	2-PIECE	30	187	113	
			F	RBK158.02	6	FC6	355X32	2-PIECE	44	201	122	
			R	RBK029.01	4	FC4-A	330X30	2-PIECE	32	187	113	
			R	RBK029.02	4	FC4-A	355X32	2-PIECE	20	199	125	
MURANO	03-07	T/PZ50	F	RBK073.01	6	FC6	355X32	2-PIECE	42	201	122	
			F	RBK073.02	8	FC8	380X34	2-PIECE	44	217	126	
			R	RBK074.01	4	FC4-A	355X32	2-PIECE	19	199	125	
PATHFINDER	05-07	R51	F	RBK216.01	6	FC6	355X32	2-PIECE	55	201	122	C
SENTRA (ALL MODEL)	00-06	B15	F	RBK063.01	4	FC4	330X30	2-PIECE	30	187	113	
			R									
SILVIA JAPAN MODEL	1/99-8/02	S15	F	RBK017.01	4	FC4	330X30	2-PIECE	30	187	113	
			F	RBK017.02	6	FC6	355X32	2-PIECE	42	201	122	
			R	RBK017.03	8	FC8	380X34	2-PIECE	44	217	126	
SKYLINE GTS (R32) JAPAN MODEL	5/89-7/93	HCR32	F	RBK017.04	4	FC4	330X30	2-PIECE	30	187	113	
			F	RBK017.05	6	FC6	355X32	2-PIECE	42	201	122	
			F	RBK017.06	8	FC8	380X34	2-PIECE	44	217	126	
			R	RBK033.05	4	FC4-A	330X30	2-PIECE	31	187	113	
			R	RBK033.03	4	FC4-A	355X32	2-PIECE	18	199	125	
			R	RBK033.04	4	FF4	380X34	2-PIECE	21	209	134	
SKYLINE GT-R (R32, R33) JAPAN MODEL	2/93-12/98	BNRHNR32 BCNR33	F	RBK017.07	4	FC4	330X30	2-PIECE	30	187	113	
			F	RBK017.08	6	FC6	355X32	2-PIECE	42	201	122	
			F	RBK017.09	8	FC8	380X34	2-PIECE	44	217	126	
			R	RBK033.01	4	FC4-A	355X32	2-PIECE	18	199	125	
			R	RBK033.02	4	FF4	380X34	2-PIECE	21	209	134	
SKYLINE GTS (R33) JAPAN MODEL	8/93-5/98	ECR33	F	RBK017.10	4	FC4	330X30	2-PIECE	30	187	113	
			F	RBK017.11	6	FC6	355X32	2-PIECE	42	201	122	
			F	RBK017.12	8	FC8	380X34	2-PIECE	44	217	126	
			R	RBK033.06	4	FC4-A	330X30	2-PIECE	31	187	113	
			R	RBK033.01	4	FC4-A	355X32	2-PIECE	18	199	125	
			R	RBK033.02	4	FF4	380X34	2-PIECE	21	209	134	
SKYLINE GT-R (R34) JAPAN MODEL	1/99-8/02	BNR34	F	RBK032.01	6	FC6	355X32	2-PIECE	36	201	122	
			F	RBK032.02	8	FC8	380X34	2-PIECE	38	217	126	
			F	RBK032.03	12	FC12	380X34	2-PIECE	39	220	138	
			R	RBK033.01	4	FC4-A	355X32	2-PIECE	18	199	125	
			R	RBK033.02	4	FF4	380X34	2-PIECE	21	209	134	
STAGEA JAPAN MODEL	9/96-10/01	WGN34	F	RBK017.07	4	FC4	330X30	2-PIECE	30	187	113	
			F	RBK017.08	6	FC6	355X32	2-PIECE	42	201	122	
			R	RBK033.07	4	FC4-A	330X30	2-PIECE	31	187	113	
			R	RBK033.01	4	FC4-A	355X32	2-PIECE	18	199	125	
STAGEA JAPAN MODEL	10/01-	M35	F	RBK017.08	6	FC6	355X32	2-PIECE	42	201	122	
			R	RBK029.01	4	FC4-A	330X30	2-PIECE	32	187	113	
			R	RBK029.02	4	FC4-A	355X32	2-PIECE	20	199	125	
TEANA JAPAN MODEL	03-	J31	F	RBK162.01	4	FC4	330X30	2-PIECE	30	187	113	
			F	RBK162.02	6	FC6	355X32	2-PIECE	44	201	122	
			R	RBK029.01	4	FC4-A	330X30	2-PIECE	32	187	113	
			R	RBK029.02	4	FC4-A	355X32	2-PIECE	20	199	125	
TITAN	04-07	A60	F	RBK075.01	8	FC8	405X36	2-PIECE	51	228	138	
XTERRA	05-07	N50	F	RBK216.01	6	FC6	355X32	2-PIECE	55	201	122	C
			R	RBK217.01	4	FC4	355X32	2-PIECE	21	199	125	C
180SX, 200SX, 240SX, SILVIA (ALL MODEL)	5/88-1/99	PS/RS/RPS13 S13/14	F	RBK017.01	4	FC4	330X30	2-PIECE	30	187	113	
			F	RBK017.02	6	FC6	355X32	2-PIECE	42	201	122	
			F	RBK017.03	8	FC8	380X34	2-PIECE	44	217	126	
			R	RBK048.01	4	FC4-A	330X30	2-PIECE	31	187	113	B
300ZX (ALL MODEL) USA, JAPAN MODEL	6/89-96	Z32	F	RBK017.01	4	FC4	330X30	2-PIECE	30	187	113	
			F	RBK017.02	6	FC6	355X32	2-PIECE	42	201	122	
			F	RBK017.03	8	FC8	380X34	2-PIECE	44	217	126	

# BRAKE SYSTEM

MAKE/MODEL	YEAR	CHASSIS	AXLE	PART #	CALIPER		DISC		WHEEL CHART			NOTES
					PISTON	TYPE	SIZE(MM)	TYPE	A (MM)	B (MM)	C (MM)	
350Z (FAIRLADY Z)	02-07	Z33	R	RBK061.01	4	FC4-A	330X30	2-PIECE	31	187	113	
			R	RBK061.02	4	FC4-A	355X32	2-PIECE	18	199	125	
			F	RBK015.01	4	FC4	330X30	2-PIECE	30	187	113	
			F	RBK015.02	6	FC6	355X32	2-PIECE	42	201	122	
			F	RBK015.03	8	FC8	380X34	2-PIECE	44	217	126	
			R	RBK029.01	4	FC4-A	330X30	2-PIECE	32	187	113	
			R	RBK029.02	4	FC4-A	355X32	2-PIECE	20	199	125	
			R	RBK029.03	4	FF4	380X34	2-PIECE	22	209	134	
<b>OLDSMOBILE</b>												
BRAVADA	02-04		F	RBK091.01	6	FC6	355X32	2-PIECE	37	201	122	
			F	RBK091.02	8	FC8	380X34	2-PIECE	39	217	126	
			R	RBK092.01	4	FF4	380X34	2-PIECE	-2	209	134	G
<b>OPEL</b>												
OPEL GT	07-		F	RBK156.01	4	FC4	330X30	2-PIECE	34	187	113	
EUROPE MODEL			R									
<b>PEUGEOT</b>												
205, 206	84-07		F	RBK142.01	4	FC4	330X30	2-PIECE	45	187	113	
EUROPE MODEL			R									
306, 307	93-07		F	RBK142.01	4	FC4	330X30	2-PIECE	45	187	113	
EUROPE MODEL			R									
<b>PONTIAC</b>												
FIREBIRD, TRANS-AM	98-02		F	RBK081.01	4	FC4	330X30	2-PIECE	27	187	113	
			R									
SOLSTICE	06-07		F	RBK156.01	4	FC4	330X30	2-PIECE	34	187	113	
			R									
SUNFIRE	95-05	JF37	F	RBK068.01	4	FC4	330X30	2-PIECE	31	187	113	A, E
			R									
VIBE	03-07	ZZE132/33	F	RBK010.01	4	FC4	295X25	1-PIECE	25	174	96	
			F	RBK010.03	4	FC4	330X30	2-PIECE	30	187	113	
			R									
<b>PORSCHE</b>												
BOXSTER, BOXSTER S (EXC CERAMIC DISC)	97-07	TYPE 986/987	F	RBK053.01	6	FC6	355X32	2-PIECE	33	201	122	
			F	RBK053.02	8	FC8	380X34	2-PIECE	35	217	126	
			R									
CAYMAN, CAYMAN S (EXC CERAMIC DISC)	06-07		F	RBK053.01	6	FC6	355X32	2-PIECE	33	201	122	
			F	RBK053.02	8	FC8	380X34	2-PIECE	35	217	126	
			R									
CAYENNE	03-07		F	RBK095.01	8	FC8	405X36	2-PIECE	25	228	138	
			F	RBK095.02	12	FC12	405X36	2-PIECE	26	228	151	
			R	RBK189.01	4	FF4	380X34	2-PIECE	10	209	134	
911 CARRERA 2, 4 (EXC TURBO)	98-07	TYPE 996/997	F	RBK053.01	6	FC6	355X32	2-PIECE	33	201	122	
			F	RBK053.02	8	FC8	380X34	2-PIECE	35	217	126	
			R	RBK054.01	4	FC4	355X32	2-PIECE	16	199	125	
			R	RBK054.02	4	FF4	380X34	2-PIECE	18	209	134	
911 CARRERA 2, 4 (TURBO) EXC CERAMIC DISC	02-07	TYPE 996/997	F	RBK108.01	12	FC12	380X34	2-PIECE	37	220	138	
			R	RBK054.01	4	FC4	355X32	2-PIECE	16	199	125	
			R	RBK054.02	4	FF4	380X34	2-PIECE	18	209	134	
911 TURBO (EXC CERAMIC DISC)	01-05	TYPE 996	F	RBK108.01	12	FC12	380X34	2-PIECE	37	220	138	
			R	RBK054.01	4	FC4	355X32	2-PIECE	16	199	125	
			R	RBK054.02	4	FF4	380X34	2-PIECE	18	209	134	
<b>RENAULT SAMSUNG</b>												
SM7	05-07		F	RBK162.01	4	FC4	330X30	2-PIECE	30	187	113	
			F	RBK162.02	6	FC6	355X32	2-PIECE	44	201	122	
			R	RBK029.01	4	FC4-A	330X30	2-PIECE	32	187	113	
			R	RBK029.02	4	FC4-A	355X32	2-PIECE	20	199	125	
<b>SAAB</b>												
9-2X (ALL MODEL)	05-06	GDA	F	RBK011.01	4	FC4	330X24	1-PIECE	15	187	113	
			F	RBK011.02	4	FC4	330X30	2-PIECE	21	187	113	
			F	RBK021.06	6	FC6	330X30	2-PIECE	32	191	108	
			F	RBK021.03	6	FC6	355X32	2-PIECE	34	201	122	
			R	RBK016.01	2	FC2-A	290X18	1-PIECE	6	171	92	

# BRAKE SYSTEM

MAKE/MODEL	YEAR	CHASSIS	AXLE		PART #	CALIPER		DISC		WHEEL CHART			NOTES
			F/R			PISTON	TYPE	SIZE(MM)	TYPE	A (MM)	B (MM)	C (MM)	
9-3 (VIGGEN)	99-02		R		RBK016.02	4	FC4	330X30	2-PIECE	13	187	113	
			F		RBK203.01	4	FC4	330X30	2-PIECE	34	187	113	
			R		RBK204.01	4	FC4-B	330X30	2-PIECE	24	187	113	
9-3 (ARC, AERO, VECTOR)	03-05		F		RBK205.01	4	FC4	330X30	2-PIECE	34	187	113	
			R										
9-5 (ARC, AERO)	99-05		F		RBK203.01	4	FC4	330X30	2-PIECE	34	187	113	
			R		RBK204.01	4	FC4-B	330X30	2-PIECE	24	187	113	
9000, 9000 TURBO	84-98		F		RBK211.01	4	FC4	330X30	2-PIECE	35	187	113	
			R										
<b>SATURN</b>													
SKY	07-		F		RBK156.01	4	FC4	330X30	2-PIECE	34	187	113	
			R										
<b>SCION</b>													
xA, xB (IST, dB)	04-07	NCP30/31 NCP60/61	F		RBK042.01	4	FC4	330X30	2-PIECE	36	187	113	
			R										
xB (dB)	08	AZE151	F		RBK218.01	4	FC4	330X30	2-PIECE	33	187	113	C
			R										
xD	08		F		RBK228.01	4	FC4	330X30	2-PIECE	33	187	113	C
			R										
tC	05-07	ANT10L	F		RBK010.01	4	FC4	295X25	1-PIECE	25	174	96	
			R		RBK010.03	4	FC4	330X30	2-PIECE	30	187	113	
<b>SEAT</b>													
LEON	99-05	M1	F		RBK052.01	4	FC4	330X30	2-PIECE	44	187	113	
EUROPE MODEL			F		RBK052.03	4	FF4	355X32	2-PIECE	47	199	121	
LEON CUPRA (4X4, V6)	01-05	M1	F		RBK052.02	4	FC4	330X30	2-PIECE	44	187	113	
			EUROPE MODEL	F		RBK052.04	4	FF4	355X32	2-PIECE	47	199	121
TOLEDO	99-04	1M2	F		RBK052.01	4	FC4	330X30	2-PIECE	44	187	113	
			EUROPE MODEL	F		RBK052.03	4	FF4	355X32	2-PIECE	47	199	121
			R										
<b>SKODA</b>													
OKTAVIA	96-04	1U	F		RBK052.01	4	FC4	330X30	2-PIECE	44	187	113	
EUROPE MODEL			F		RBK052.03	4	FF4	355X32	2-PIECE	47	199	121	
			R										
<b>SUBARU</b>													
BAJA	03-06	B12	F		RBK011.01	4	FC4	330X24	1-PIECE	15	187	113	
			F		RBK011.02	4	FC4	330X30	2-PIECE	21	187	113	
			F		RBK021.06	6	FC6	330X30	2-PIECE	32	191	108	
			F		RBK021.03	6	FC6	355X32	2-PIECE	34	201	122	
			R		RBK016.05	2	FC2-A	290X18	1-PIECE	6	171	92	
			R		RBK016.06	4	FC4	330X30	2-PIECE	13	187	113	
FORESTER	98-02	SF5	F		RBK011.03	4	FC4	330X24	1-PIECE	15	187	113	
			F		RBK011.04	4	FC4	330X30	2-PIECE	21	187	113	
			F		RBK021.07	6	FC6	330X30	2-PIECE	32	191	108	
			F		RBK021.04	6	FC6	355X32	2-PIECE	34	201	122	
			R		RBK016.01	2	FC2-A	290X18	1-PIECE	6	171	92	
			R		RBK016.02	4	FC4	330X30	2-PIECE	13	187	113	
FORESTER	03-07	SG5	F		RBK011.01	4	FC4	330X24	1-PIECE	15	187	113	
			F		RBK011.02	4	FC4	330X30	2-PIECE	21	187	113	
			F		RBK021.06	6	FC6	330X30	2-PIECE	32	191	108	
			F		RBK021.03	6	FC6	355X32	2-PIECE	34	201	122	
			R		RBK016.01	2	FC2-A	290X18	1-PIECE	6	171	92	
			R		RBK016.02	4	FC4	330X30	2-PIECE	13	187	113	
IMPREZA	11/92-01	GC6/8	F		RBK011.03	4	FC4	330X24	1-PIECE	15	187	113	
			F		RBK011.04	4	FC4	330X30	2-PIECE	21	187	113	
			F		RBK021.07	6	FC6	330X30	2-PIECE	32	191	108	
			F		RBK021.04	6	FC6	355X32	2-PIECE	34	201	122	
			R		RBK016.01	2	FC2-A	290X18	1-PIECE	6	171	92	
			R		RBK016.02	4	FC4	330X30	2-PIECE	13	187	113	
IMPREZA 2.5RS	02-07	GDA/GGA	F		RBK011.01	4	FC4	330X24	1-PIECE	15	187	113	
			F		RBK011.02	4	FC4	330X30	2-PIECE	21	187	113	

# BRAKE SYSTEM

MAKE/MODEL	YEAR	CHASSIS	AXLE	PART #	CALIPER		DISC		WHEEL CHART			NOTES
			F/R		PISTON	TYPE	SIZE(MM)	TYPE	A (MM)	B (MM)	C (MM)	
			F	RBK021.06	6	FC6	330X30	2-PIECE	32	191	108	
			F	RBK021.03	6	FC6	355X32	2-PIECE	34	201	122	
			R	RBK016.01	2	FC2-A	290X18	1-PIECE	6	171	92	
			R	RBK016.02	4	FC4	330X30	2-PIECE	13	187	113	
IMPREZA OUTBACK	95-01	GC6/8	F	RBK011.03	4	FC4	330X24	1-PIECE	15	187	113	
			F	RBK011.04	4	FC4	330X30	2-PIECE	21	187	113	
			F	RBK021.07	6	FC6	330X30	2-PIECE	32	191	108	
			F	RBK021.04	6	FC6	355X32	2-PIECE	34	201	122	
			R	RBK016.01	2	FC2-A	290X18	1-PIECE	6	171	92	
			R	RBK016.02	4	FC4	330X30	2-PIECE	13	187	113	
IMPREZA OUTBACK	02-07	GDA	F	RBK011.01	4	FC4	330X24	1-PIECE	15	187	113	
			F	RBK011.02	4	FC4	330X30	2-PIECE	21	187	113	
			F	RBK021.06	6	FC6	330X30	2-PIECE	32	191	108	
			F	RBK021.03	6	FC6	355X32	2-PIECE	34	201	122	
			R	RBK016.01	2	FC2-A	290X18	1-PIECE	6	171	92	
			R	RBK016.02	4	FC4	330X30	2-PIECE	13	187	113	
IMPREZA WRX	02-05	GDA/GGA	F	RBK011.01	4	FC4	330X24	1-PIECE	15	187	113	
			F	RBK011.02	4	FC4	330X30	2-PIECE	21	187	113	
			F	RBK021.06	6	FC6	330X30	2-PIECE	32	191	108	
			F	RBK021.03	6	FC6	355X32	2-PIECE	34	201	122	
			R	RBK016.01	2	FC2-A	290X18	1-PIECE	6	171	92	
			R	RBK016.02	4	FC4	330X30	2-PIECE	13	187	113	
IMPREZA WRX EUROPE, JAPAN, USA MODEL	06-07	GDA/GGA	F	RBK011.05	4	FC4	330X24	1-PIECE	15	187	113	
			F	RBK011.06	4	FC4	330X30	2-PIECE	21	187	113	
			F	RBK021.05	6	FC6	330X30	2-PIECE	32	191	108	
			F	RBK021.01	6	FC6	355X32	2-PIECE	34	201	122	
IMPREZA WRX	08	GHA	F	RBK022.02	4	FC4-A	330X30	2-PIECE	25	187	113	
			F	RBK011.05	4	FC4	330X24	1-PIECE	15	187	113	
			F	RBK011.06	4	FC4	330X30	2-PIECE	21	187	113	
			F	RBK021.05	6	FC6	330X30	2-PIECE	32	191	108	
			F	RBK021.01	6	FC6	355X32	2-PIECE	34	201	122	
			R	RBK227.01	2	FC2	330X30	2-PIECE	24	189	112	C
IMPREZA WRX STI USA MODEL	1/03-07	GDF	F	RBK227.02	4	FC4	330X30	2-PIECE	17	187	113	C
			F	RBK021.05	6	FC6	330X30	2-PIECE	32	191	108	
			F	RBK021.01	6	FC6	355X32	2-PIECE	34	201	122	
			R	RBK022.01	4	FC4-A	330X30	2-PIECE	25	187	113	
IMPREZA WRX STI EUROPE, JAPAN MODEL	1/03-07	GDA/B/F	F	RBK016.02	4	FC4	330X30	2-PIECE	13	187	113	
			F	RBK021.05	6	FC6	330X30	2-PIECE	32	191	108	
			F	RBK021.01	6	FC6	355X32	2-PIECE	34	201	122	
LEGACY	90-99	BD/BG5	R	RBK016.02	4	FC4	330X30	2-PIECE	13	187	113	
			F	RBK011.03	4	FC4	330X24	1-PIECE	15	187	113	
			F	RBK011.04	4	FC4	330X30	2-PIECE	21	187	113	
			F	RBK021.07	6	FC6	330X30	2-PIECE	32	191	108	
			F	RBK021.04	6	FC6	355X32	2-PIECE	34	201	122	
			R	RBK016.01	2	FC2-A	290X18	1-PIECE	6	171	92	
LEGACY (L, L-S, 2.5i)	00-07	BH/BL/BP5/9	R	RBK016.02	4	FC4	330X30	2-PIECE	13	187	113	
			F	RBK011.01	4	FC4	330X24	1-PIECE	15	187	113	
			F	RBK011.02	4	FC4	330X30	2-PIECE	21	187	113	
			F	RBK021.06	6	FC6	330X30	2-PIECE	32	191	108	
			F	RBK021.03	6	FC6	355X32	2-PIECE	34	201	122	
			R	RBK016.05	2	FC2-A	290X18	1-PIECE	6	171	92	
LEGACY (GT, GT LTD, 2.5 GT)	00-07	BH/BL/BP5/9	R	RBK016.06	4	FC4	330X30	2-PIECE	13	187	113	
			F	RBK011.01	4	FC4	330X24	1-PIECE	15	187	113	
			F	RBK011.02	4	FC4	330X30	2-PIECE	21	187	113	
			F	RBK021.06	6	FC6	330X30	2-PIECE	32	191	108	
			F	RBK021.03	6	FC6	355X32	2-PIECE	34	201	122	
			R	RBK016.03	2	FC2-A	290X18	1-PIECE	6	171	92	
OUTBACK	00-04	GDA	R	RBK016.04	4	FC4	330X30	2-PIECE	13	187	113	
			F	RBK011.01	4	FC4	330X24	1-PIECE	15	187	113	
			F	RBK011.02	4	FC4	330X30	2-PIECE	21	187	113	
			F	RBK021.06	6	FC6	330X30	2-PIECE	32	191	108	
			F	RBK021.03	6	FC6	355X32	2-PIECE	34	201	122	
			R	RBK016.03	2	FC2-A	290X18	1-PIECE	6	171	92	
OUTBACK	05-07	GDA	R	RBK016.04	4	FC4	330X30	2-PIECE	13	187	113	
			F	RBK011.01	4	FC4	330X24	1-PIECE	15	187	113	
			F	RBK011.02	4	FC4	330X30	2-PIECE	21	187	113	
			F	RBK021.06	6	FC6	330X30	2-PIECE	32	191	108	
			F	RBK021.03	6	FC6	355X32	2-PIECE	34	201	122	
			R	RBK016.05	2	FC2-A	290X18	1-PIECE	6	171	92	

# BRAKE SYSTEM

MAKE/MODEL	YEAR	CHASSIS	AXLE	PART #	CALIPER		DISC		WHEEL CHART			NOTES
					PISTON	TYPE	SIZE(MM)	TYPE	A (MM)	B (MM)	C (MM)	
			F/R									
			R	RBK016.06	4	FC4	330X30	2-PIECE	13	187	113	
<b>SUZUKI</b>												
SX4	07-	YB41	F	RBK167.01	4	FC4	330X30	2-PIECE	32	187	113	
			F	RBK167.02	4	FF4	355X32	2-PIECE	37	199	121	
			R									
<b>TOYOTA</b>												
ALPHARD JAPAN MODEL	02-	ANH10/15W MNH10/15W	F	RBK062.01	4	FC4	330X30	2-PIECE	30	187	113	
			F	RBK084.01	6	FC6	355X32	2-PIECE	44	201	122	
			R	RBK170.01	4	FC4-A	330X30	2-PIECE	11	187	113	F
AVALON	95-04	MCX10/20	F	RBK062.01	4	FC4	330X30	2-PIECE	30	187	113	
			R									
AVALON	05-07	GSX30	F	RBK062.01	4	FC4	330X30	2-PIECE	30	187	113	
			F	RBK084.01	6	FC6	355X32	2-PIECE	44	201	122	
			R	RBK139.01	2	FC2	330X30	2-PIECE	19	189	112	F
			R	RBK139.02	4	FC4	330X30	2-PIECE	14	187	113	F
CAMRY	92-99	MCV/SXV10 MCV/SXV20	F	RBK062.01	4	FC4	330X30	2-PIECE	30	187	113	
			R									
CAMRY	00-01	MCV/SXV20	F	RBK062.01	4	FC4	330X30	2-PIECE	30	187	113	
			R	RBK139.03	2	FC2	330X30	2-PIECE	19	189	112	F
			R	RBK139.04	4	FC4	330X30	2-PIECE	14	187	113	F
CAMRY	02-06	ACV/MCV30 MCV31	F	RBK062.01	4	FC4	330X30	2-PIECE	30	187	113	
			F	RBK084.01	6	FC6	355X32	2-PIECE	44	201	122	
			R	RBK139.01	2	FC2	330X30	2-PIECE	19	189	112	F
			R	RBK139.02	4	FC4	330X30	2-PIECE	14	187	113	F
CAMRY	07	AHV/ACV40	F	RBK062.01	4	FC4	330X30	2-PIECE	30	187	113	
			F	RBK084.01	6	FC6	355X32	2-PIECE	44	201	122	
			R	RBK139.05	4	FC4	330X30	2-PIECE	13	187	113	
CELICA GT, GTS	00-05	ZZT230/231	F	RBK010.01	4	FC4	295X25	1-PIECE	25	174	96	
			F	RBK010.03	4	FC4	330X30	2-PIECE	30	187	113	
			R									
CHASER, CRESTA, MARK II JAPAN MODEL	92-10/00	JZX90/100	F	RBK013.01	4	FC4	330X32	1-PIECE	30	187	113	
			F	RBK013.02	4	FC4	330X30	2-PIECE	28	187	113	
			F	RBK013.03	6	FC6	355X32	2-PIECE	41	201	122	
			R									
CHASER, CRESTA, MARK II JAPAN MODEL	10/00-	JZX110	F	RBK013.01	4	FC4	330X32	1-PIECE	30	187	113	
			F	RBK013.02	4	FC4	330X30	2-PIECE	28	187	113	
			F	RBK013.03	6	FC6	355X32	2-PIECE	41	201	122	
			R	RBK027.03	4	FC4	330X30	2-PIECE	16	187	113	
			R	RBK027.04	4	FC4	355X32	2-PIECE	18	199	125	
COROLLA	84-85	AE85	F	RBK103.01	6	FM6	257X21	2-PIECE	-	-	-	
			R									
COROLLA	86-87	AE86	F	RBK103.02	6	FM6	257X21	2-PIECE	-	-	-	
			R									
COROLLA	03-07	ZZE130/131	F	RBK010.01	4	FC4	295X25	1-PIECE	25	174	96	
			F	RBK010.03	4	FC4	330X30	2-PIECE	30	187	113	
			R									
CROWN JAPAN MODEL	9/99-11/03	JZS171	F	RBK013.01	4	FC4	330X32	1-PIECE	30	187	113	
			F	RBK013.02	4	FC4	330X30	2-PIECE	28	187	113	
			F	RBK013.03	6	FC6	355X32	2-PIECE	41	201	122	
			R	RBK027.03	4	FC4	330X30	2-PIECE	16	187	113	
			R	RBK027.04	4	FC4	355X32	2-PIECE	18	199	125	
CROWN MAJESTA JAPAN MODEL	06-	UZS186/187	F	RBK174.01	4	FF4	355X32	2-PIECE	33	199	121	C
			F	RBK174.02	6	FC6	355X32	2-PIECE	42	201	122	C
			R	RBK164.01	4	FC4	355X32	2-PIECE	12	199	125	
ESTIMA JAPAN MODEL	00-05	ACR30/40W MCR30/40W	F	RBK062.01	4	FC4	330X30	2-PIECE	30	187	113	
			F	RBK084.01	6	FC6	355X32	2-PIECE	44	201	122	
			R	RBK170.01	4	FC4-A	330X30	2-PIECE	11	187	113	F
FJ CRUISER	07-	GSJ15	F	RBK082.01	6	FC6	355X32	2-PIECE	21	201	122	
			R	RBK059.01	4	FC4	355X32	2-PIECE	13	199	125	
HIGHLANDER (KLUGER)	01-03	ACU20/25 MCU20/25	F	RBK084.01	6	FC6	355X32	2-PIECE	44	201	122	
			R									
HIGHLANDER (KLUGER)	04-07	ACU20/25 MCU21/26	F	RBK084.01	6	FC6	355X32	2-PIECE	44	201	122	
			R	RBK085.01	4	FC4-A	330X30	2-PIECE	10	187	113	
MARK II QUALIS JAPAN MODEL	97-01	SXV20W MVV21W	F	RBK062.01	4	FC4	330X30	2-PIECE	30	187	113	
			F	RBK084.01	6	FC6	355X32	2-PIECE	44	201	122	
			R									

# BRAKE SYSTEM

MAKE/MODEL	YEAR	CHASSIS	AXLE		PART #	CALIPER		DISC		WHEEL CHART			NOTES
			F/R			PISTON	TYPE	SIZE(MM)	TYPE	A (MM)	B (MM)	C (MM)	
LANDCRUISER (LANDCRUISER 100)	98-07	UZJ100	F		RBK080.01	6	FC6	355X32	2-PIECE	-	-	-	
			F		RBK080.02	8	FC8	405X36	2-PIECE	-	-	-	A
			R		RBK147.01	8	FC8	405X36	2-PIECE	-9	228	138	A
MATRIX XR, XRS	03-07	ZZE136/138	F		RBK010.01	4	FC4	295X25	1-PIECE	25	174	96	
			F		RBK010.03	4	FC4	330X30	2-PIECE	30	187	113	
			R										
MR 2 USA, JAPAN MODEL	90-99	SW20/21	F		RBK009.01	4	FC4	330X30	1-PIECE	31	187	113	
			F		RBK009.02	4	FC4	330X30	2-PIECE	31	187	113	
			R		RBK047.01	4	FC4	330X30	2-PIECE	33	187	113	B
MRS SPYDER	00-05	ZZW30	F		RBK014.01	4	FC4	330X30	1-PIECE	35	187	113	
			F		RBK014.02	4	FC4	330X30	2-PIECE	35	187	113	
			R										
RAV 4	01-05	ACA21/23 ACA26/28	F		RBK062.02	4	FC4	330X30	2-PIECE	30	187	113	
			R										
SEQUOIA	01-07	UCK35/45	F		RBK058.01	6	FC6	355X32	2-PIECE	13	201	122	
			R		RBK059.01	4	FC4	355X32	2-PIECE	13	199	125	
SIENNA	04-07	MCL20/25	F		RBK062.01	4	FC4	330X30	2-PIECE	30	187	113	
			F		RBK084.01	6	FC6	355X32	2-PIECE	44	201	122	
			R		RBK170.01	4	FC4-A	330X30	2-PIECE	11	187	113	F
SOLARA	99-03	MCV/SXV20	F		RBK062.01	4	FC4	330X30	2-PIECE	30	187	113	
			R		RBK139.03	2	FC2	330X30	2-PIECE	19	189	112	F
			R		RBK139.04	4	FC4	330X30	2-PIECE	14	187	113	F
SOLARA	04-07	MCV31	F		RBK062.01	4	FC4	330X30	2-PIECE	30	187	113	
			F		RBK084.01	6	FC6	355X32	2-PIECE	44	201	122	
			R		RBK139.01	2	FC2	330X30	2-PIECE	19	189	112	F
			R		RBK139.02	4	FC4	330X30	2-PIECE	14	187	113	F
SUPRA USA, JAPAN MODEL	86-93	MA70	F		RBK194.01	4	FF4	355X32	2-PIECE	28	199	121	C
			R		RBK195.01	4	FC4	355X32	2-PIECE	13	199	125	C
SUPRA USA, JAPAN MODEL	93-02	JZA80	F		RBK024.06	4	FC4	330X32	1-PIECE	30	187	113	
			F		RBK024.07	4	FC4	330X30	2-PIECE	28	187	113	
			F		RBK024.08	4	FF4	355X32	2-PIECE	31	199	121	
			F		RBK024.09	6	FC6	355X32	2-PIECE	41	201	122	
			F		RBK024.10	8	FC8	380X34	2-PIECE	47	217	126	
TACOMA 2WD (2.4L, 4CYL.)	95-04	RZN140/150	F		RBK065.01	4	FC4	330X30	2-PIECE	-	-	-	
			R										
TACOMA (X-RUNNER): 2WD; 5 LUG	05-07	GRN225	F		RBK102.01	4	FC4	330X30	2-PIECE	20	187	113	
			F		RBK102.02	6	FC6	355X32	2-PIECE	35	201	122	
TACOMA (PRE-RUNNER): 4WD; 6 LUG	05-07	TRN240/245 GRN245/250	F		RBK082.01	6	FC6	355X32	2-PIECE	21	201	122	
			R										
TUNDRA	00-06	UCK/VCK30/40	F		RBK058.01	6	FC6	355X32	2-PIECE	12	201	122	
TUNDRA	07	GSK50/51 USK/UCK50-57	F		RBK219.01	12	FC12	405X36	2-PIECE	12	228	151	C
			R		RBK224.01	8	FC8	405X36	2-PIECE	16	228	138	A, C
YARIS (VITZ, BELTA) USA, JAPAN MODEL	05-07	NCP91/93	F		RBK199.01	4	FC4	330X30	2-PIECE	33	187	113	C
			R										
4 RUNNER (HILUX SURF)	03-07	GRNUZ21	F		RBK082.01	6	FC6	355X32	2-PIECE	21	201	122	
			R		RBK059.01	4	FC4	355X32	2-PIECE	13	199	125	
<b>VOLKSWAGEN</b>													
BORA 1.8T	98-04	1J2	F		RBK052.01	4	FC4	330X30	2-PIECE	44	187	113	
			F		RBK052.03	4	FF4	355X32	2-PIECE	47	199	121	
			R										
CORRADO	89-95	MK2	F		RBK101.01	4	FC4	330X30	2-PIECE	40	187	113	
EOS	07	MK5	F		RBK111.01	4	FC4	330X30	2-PIECE	29	187	113	
			R										
GOLF (EXC VR6)	93-11/98	MK3	F		RBK101.01	4	FC4	330X30	2-PIECE	40	187	113	
GOLF (1.8T, VR6); EXC 2.0 TURBO	12/98-06	MK4	F		RBK052.01	4	FC4	330X30	2-PIECE	44	187	113	
			F		RBK052.03	4	FF4	355X32	2-PIECE	47	199	121	
			R										
GOLF (GTI 2.0 TURBO)	06-07	MK5	F		RBK111.01	4	FC4	330X30	2-PIECE	29	187	113	
			R										
GOLF R32 EUROPE MODEL	9/02-		F		RBK052.02	4	FC4	330X30	2-PIECE	44	187	113	
			F		RBK052.04	4	FF4	355X32	2-PIECE	47	199	121	

# BRAKE SYSTEM

MAKE/MODEL	YEAR	CHASSIS	AXLE	PART #	CALIPER		DISC		WHEEL CHART			NOTES
					PISTON	TYPE	SIZE(MM)	TYPE	A (MM)	B (MM)	C (MM)	
JETTA 2, 3 (EXC VR6)	90-9/98	MK2/3	F R	RBK101.01	4	FC4	330X30	2-PIECE	40	187	113	
JETTA (1.8T, VR6)	10/98-12/04	MK4	F F R	RBK052.01 RBK052.03	4 4	FC4 FF4	330X30 355X32	2-PIECE 2-PIECE	44 47	187 199	113 121	
JETTA (2.5L, 2.0L TURBO)	05-07	MK5	F R	RBK111.01	4	FC4	330X30	2-PIECE	29	187	113	
NEW BEETLE (TURBO)	98-07		F F R	RBK052.01 RBK052.03	4 4	FC4 FF4	330X30 355X32	2-PIECE 2-PIECE	44 47	187 199	113 121	
PASSAT (EXC VR6)	90-97	B3/4	F R	RBK101.01	4	FC4	330X30	2-PIECE	40	187	113	
PASSAT (FWD)	98-05	B5, B5G	F F R	RBK056.01 RBK056.02	4 4	FC4 FF4	330X30 355X32	2-PIECE 2-PIECE	32 35	187 199	113 121	
PASSAT (2.0L TURBO, 3.6L)	06-07	MK5	F R	RBK111.01	4	FC4	330X30	2-PIECE	29	187	113	
PASSAT AWD (EXC W8)	02-05	B5G	F F R	RBK056.03 RBK057.02	4 6	FC4 FC6	330X30 355X32	2-PIECE 2-PIECE	32 45	187 201	113 122	
PHAETON	04-06		F F R	RBK112.02 RBK112.01	6 8	FC6 FC8	355X32 380X34	2-PIECE 2-PIECE	32 34	201 217	122 126	
RABBIT	07		F R	RBK111.01	4	FC4	330X30	2-PIECE	29	187	113	
TOUAREG	04-07	7LA	F F R	RBK095.01 RBK095.02 RBK189.01	8 12 4	FC8 FC12 FF4	405X36 405X36 380X34	2-PIECE 2-PIECE 2-PIECE	25 26 10	228 228 209	138 151 134	
TOURAN EUROPE MODEL	03-		F R	RBK111.01	4	FC4	330X30	2-PIECE	29	187	113	
<b>VOLVO</b>												
C30	07		F R	RBK161.01	4	FC4	330X30	2-PIECE	33	187	114	
C70	97-04		F R	RBK208.01 RBK209.01	4 2	FC4 FC2	330X30 330X30	2-PIECE 2-PIECE	29 13	187 189	113 112	
C70	06-07		F R	RBK161.01	4	FC4	330X30	2-PIECE	33	187	114	
S40	00-04		F R	RBK072.01	4	FC4	330X30	2-PIECE	33	187	113	
S40	05-07		F R	RBK161.01	4	FC4	330X30	2-PIECE	33	187	114	
S60	01-07		F F R	RBK206.01 RBK206.02 RBK207.01	4 6 4	FC4 FC6 FC4	330X30 355X32 330X30	2-PIECE 2-PIECE 2-PIECE	29 42 31	187 201 187	113 122 113	
S70 (2WD)	97-00		F R	RBK208.01 RBK209.01	4 2	FC4 FC2	330X30 330X30	2-PIECE 2-PIECE	29 13	187 189	113 112	
S70 (AWD)	99-00		F R	RBK208.01	4	FC4	330X30	2-PIECE	29	187	113	
S80	99-06		F F R	RBK206.01 RBK206.02 RBK207.01	4 6 4	FC4 FC6 FC4	330X30 355X32 330X30	2-PIECE 2-PIECE 2-PIECE	29 42 31	187 201 187	113 122 113	
V40	00-04		F R	RBK072.01	4	FC4	330X30	2-PIECE	33	187	113	
V50	05-07		F R	RBK161.01	4	FC4	330X30	2-PIECE	33	187	114	
V70 (EXC R, XC): 2WD	97-00		F R	RBK208.01 RBK209.01	4 2	FC4 FC2	330X30 330X30	2-PIECE 2-PIECE	29 13	187 189	113 112	
V70 (EXC R, XC): AWD	97-00		F R	RBK208.01	4	FC4	330X30	2-PIECE	29	187	113	
V70 (EXC R, XC)	01-07		F F R	RBK206.01 RBK206.02 RBK207.01	4 6 4	FC4 FC6 FC4	330X30 355X32 330X30	2-PIECE 2-PIECE 2-PIECE	29 42 31	187 201 187	113 122 113	
V70 R (AWD)	98-00		F R	RBK208.01	4	FC4	330X30	2-PIECE	29	187	113	
V70 R (AWD)	04-07		F F R	RBK206.01 RBK206.02 RBK207.01	4 6 4	FC4 FC6 FC4	330X30 355X32 330X30	2-PIECE 2-PIECE 2-PIECE	29 42 31	187 201 187	113 122 113	



# BRAKE SYSTEM

MAKE/MODEL	YEAR	CHASSIS	AXLE	PART #	CALIPER		DISC		WHEEL CHART			NOTES
			F/R		PISTON	TYPE	SIZE(MM)	TYPE	A (MM)	B (MM)	C (MM)	
V70 XC (AWD)	98-00		F	RBK208.01	4	FC4	330X30	2-PIECE	29	187	113	
V70 XC (AWD)	01-02		F	RBK206.01	4	FC4	330X30	2-PIECE	29	187	113	
			F	RBK206.02	6	FC6	355X32	2-PIECE	42	201	122	
			R	RBK207.01	4	FC4	330X30	2-PIECE	31	187	113	
XC70 (AWD)	03-07		F	RBK206.01	4	FC4	330X30	2-PIECE	29	187	113	
			F	RBK206.02	6	FC6	355X32	2-PIECE	42	201	122	
			R	RBK207.01	4	FC4	330X30	2-PIECE	31	187	113	
XC90	03-07		F	RBK210.01	6	FC6	355X32	2-PIECE	42	201	122	
			R	RBK207.01	4	FC4	330X30	2-PIECE	31	187	113	
850 SERIES	91-97		F	RBK208.01	4	FC4	330X30	2-PIECE	29	187	113	
			R	RBK209.01	2	FC2	330X30	2-PIECE	13	189	112	

## NOTES:

A=SPECIAL ORDER ONLY (LEAD TIME 60-90 DAYS DEPENDING ON APPLICATION)

B=(RACE ONLY) WITHOUT E-BRAKE

C=NEW (CONTACT ROTORA FOR AVAILABILITY)

D=LARGER STOCK MODEL DIAMETER BRAKE DISCS MUST BE UPGRADED WHEN USING THIS KIT (PLEASE CALL ROTORA FOR FURTHER ASSISTANCE)

E=ONE SET OF FRONT MODIFIED O.E KNUCKLE WILL BE SUPPLIED ALONG WITH A CORE CHARGE OF \$400.00USD

F=FOR REAR DISC MODELS ONLY (NOT REAR DRUM TO BRAKE DISC CONVERSION)

G=REAR STAINLESS STEEL BRAIDED BRAKE LINES NOT INCLUDED (REAR BRAKE SYSTEM UTILIZES ORIGINAL BRAKE LINE)

## PART NUMBER INFORMATION:

ADD LETTER TO THE END OF THE PART# TO INDICATE CALIPER COLOR (A=RED OR M=METALLIC BLUE). EXAMPLE: RBK004.01A

CUSTOM CALIPER COLOR: ADD \$300.00USD PER CALIPER SET SURCHARGE. LEADTIME 60-90 DAYS (DEPENDING ON APPLICATION)

CUSTOM CALIPER COLOR INCLUDE (B=DARK BLUE, C=CHROME, D=GUNMETAL, E=GOLD, F=SILVER, G=BLACK, K=ORANGE, Y=YELLOW)

ADD "S" (SLOTTED DISC) OR "C" (CROSS-DRILLED & SLOTTED) TO THE END OF THE CALIPER COLOR LETTER FOR DISC TYPE. EXAMPLE: RBK004.01AS

## GENERAL INFORMATION:

LEFT: DRIVER SIDE, RIGHT: PASSENGER SIDE (NORTH AMERICA)

UNLESS OTHERWISE SPECIFIED, ALL BRAKE SYSTEMS ARE FOR NORTH AMERICAN VEHICLES

ROTORA BRAKE SYSTEM MAY REQUIRE MINOR MODIFICATION OR REMOVAL OF THE OEM DUST COVER SHIELD/BACKING PLATE

## BIG BRAKE SYSTEM STANDARD COMPONENTS: (PER AXLE)

A SET OF PRE-INSTALLED BILLET CALIPERS

A SET OF 1 OR 2-PIECE SYSTEM OVERSIZE HEATED TREATED, VENTED DISCS (SLOTTED OR DRILLED & SLOTTED)

A SET OF STAINLESS STEEL BRAIDED BRAKE LINES (DOT COMPLIANT)

A SET OF T-BILLET 7075 GRADE MOUNTING BRACKETS (DEPENDING ON APPLICATION)

A SET OF H2 CERAMIC FORMULATED PADS

OPTIONAL: HIGHER CERAMIC PAD GRADES AVAILABLE (PLEASE CALL ROTORA FOR FURTHER ASSISTANCE IN PAD GRADE SELECTION)

# CALIPER KIT

MAKE/MODEL	YEAR	CHASSIS	AXLE	PART #	CALIPER		DISC	WHEEL CHART			NOTES
					PISTON	TYPE		SIZE(MM)	A (MM)	B (MM)	
<b>ACURA</b>											
CL (3.0 V6)	98-99	YA22	F R	RCK006.05	4	FM4-C	282X23	26	163	88	
CL (3.2 V6)	01-03	YA4	F R	RCK003.01	4	FC4-B	300X28	30	176	98	C
CSX CANADA MODEL	06-07	CL9	F R	RCK003.02	4	FC4-B	300X28	30	176	98	C
EL CANADA MODEL	06	CL9	F R	RCK003.02	4	FC4-B	300X28	30	176	98	C
INTEGRA TYPE R	97-01	DC2	F R	RCK006.02	4	FM4-C	282X23	26	163	88	
LEGEND SEDAN	91-95	KA7/8	F R	RCK006.10	4	FM4-C	282X23	26	163	88	
RL	96-98	KA96	F R	RCK006.10	4	FM4-C	282X23	26	163	88	
RL	99-04	KA96	F R	RCK006.11	4	FM4-C	282X23	26	163	88	
RSX (EXC TYPE-S)	02-06	DC5	F R	RCK001.01	4	FM4-B	300X25	27	170	98	D
RSX-S	02-06	DC5	F R	RCK001.02	4	FM4-B	300X25	27	170	98	
TL (2.5L)	95-98	UA26	F R	RCK006.03	4	FM4-C	282X23	26	163	88	
TL (3.2L)	96-98	UA36	F R	RCK006.10	4	FM4-C	282X23	26	163	88	
TL, TL TYPE-S	99-03	UA4/5	F R	RCK003.01	4	FC4-B	300X28	30	176	98	C
TL, TL TYPE-S (STD FRONT CALIPER)	04-07	UA6	F R	RCK003.02	4	FC4-B	300X28	30	176	98	C
TSX	04-07	CL7/9	F R	RCK003.02	4	FC4-B	300X28	30	176	98	C
VIGOR	92-94	CC2	F R	RCK006.03	4	FM4-C	282X23	26	163	88	
<b>BMW</b>											
M3	95-99	E36	F R	RCK025.01	4	FF4	315X28	26	184	102	
				RCK026.01	4	FM4	312X20.2	9	176	104	
M3 (EXC COMPETITION PKG)	01-07	E46	F R	RCK038.01	4	FF4	325X28	26	188	106	
				RCK039.01	4	FM4-B	327X20	8	183	112	
M3 (W/ COMPETITION PKG); CSL	06-07	E46	F R	RCK038.02	4	FF4	345X28	26	198	116	C
				RCK202.01	4	FM4-B	328X20	7	183	112	C
Z3 (EXC M SERIES)	96-02	E36	F R	RCK049.02	4	FM4-A	300X22	19	170	98	D
Z3 (M SERIES)	98-02	E36/37	F R	RCK025.01	4	FF4	315X28	26	184	102	
				RCK148.01	4	FM4	312X20.2	9	176	104	
Z4 (2.5L); EXC M SERIES	03-06	E85/86	F R	RCK049.02	4	FM4-A	300X22	19	170	98	D
				RCK050.02	2	FC2	294X19	-1	172	94	D
Z4 (3.0L); EXC M SERIES	03-07	E85/86	F R	RCK049.01	4	FM4-A	300X22	19	170	98	
				RCK050.01	2	FC2	294X19	-1	172	94	
Z4 (M SERIES); 3.2L	06-07	E86	F R	RCK038.02	4	FF4	345X28	26	198	116	C
				RCK202.01	4	FM4-B	328X20	7	183	112	C
318, 323, 325, 328 SERIES	10/90-99	E36	F R	RCK049.02	4	FM4-A	300X22	19	170	98	D
323, 325, 328 SERIES	99-07	E46	F R	RCK049.01	4	FM4-A	300X22	19	170	98	
325, 328 SERIES	06-07	E90/91/92	F R	RCK113.01	4	FC4	329.5X24	-1	187	113	C, D
				RCK114.01	4	FC4	335.5X22	6	190	116	C, D
330 SERIES	06	E90	F R	RCK113.02	4	FC4	329.5X24	-1	187	113	C
				RCK114.02	4	FC4	335.5X22	6	190	116	C
335 SERIES	07	E90/92	F R	RCK113.03	6	FC6	347.5X30	18	198	119	C
				RCK114.02	4	FC4	335.5X22	6	190	116	C
<b>CADILLAC</b>											
XLR (EXC V SERIES)	04-07		F R	RCK123.01	4	FF4	340X32	36	194	114	D
				RCK124.01	4	FM4	330X26	26	184	113	D
<b>CHEVROLET</b>											
CORVETTE (BASE MODEL)	05-07	C6	F	RCK123.01	4	FF4	340X32	36	194	114	D

# CALIPER KIT

MAKE/MODEL	YEAR	CHASSIS	AXLE	PART #	CALIPER		DISC SIZE(MM)	WHEEL CHART			NOTES
			F/R		PISTON	TYPE		A (MM)	B (MM)	C (MM)	
CORVETTE (Z51)	05-07	C6	R	RCK124.01	4	FM4	330X26	26	184	113	D
			F	RCK123.02	4	FF4	340X32	36	194	114	
			R	RCK124.02	4	FM4	330X26	26	184	113	
CORVETTE (Z06)	06-07	C6	F	RCK123.03	6	FC6	355X32	48	201	122	C
			R	RCK124.03	4	FC4	340X26	32	192	118	C
<b>FORD</b>											
FOCUS EUROPE MODEL (5X108MM PCD)	05-07		F R	RCK161.02	4	FC4	300X25	26	176	98	C, D
FOCUS	05-07	DAW	F R	RCK201.02	4	FM4	300X24	29	170	98	C, D
FOCUS SVT	02-04	ST170	F R	RCK201.01	4	FM4	300X24	29	170	98	C
MUSTANG (COBRA, BULLIT)	94-04	SN95	F R	RCK020.01	4	FC4	330X28	33	191	108	
<b>HONDA</b>											
ACCORD (V6)	98-02	CG1/2/3	F R	RCK006.01	4	FM4-C	282X23	26	163	88	
ACCORD (ALL MODEL) EXC. 6 SPEED M/T	03-07	CM5-CM8	F R	RCK006.08	4	FM4-C	282X23	26	163	88	
ACCORD (6 SPEED M/T)	03-07	CM5-CM8	F R	RCK003.02	4	FC4-B	300X28	30	176	98	C
CIVIC COUPE DX, EX, LX (1.8L)	06-07	FG1	F R	RCK143.02	4	FM4	300X25	27	170	98	D
CIVIC COUPE Si (2.0L)	06-07	FG2	F R	RCK143.01	4	FM4	300X25	27	170	98	
CIVIC HATCHBACK Si	04-05	EP3	F R	RCK001.01	4	FM4-B	300X25	27	170	98	D
CR-V	97-01	RD1-5	F R	RCK006.06	4	FM4-C	282X23	26	163	88	
CR-V	02-04	RD6	F R	RCK006.09	4	FM4-C	282X23	26	163	88	
CR-V	05-06	RD7	F R	RCK001.02	4	FM4-B	300X25	27	170	98	
ELEMENT	03-07	YH1/2	F R	RCK006.09	4	FM4-C	282X23	26	163	88	
ODYSSEY USA MODEL	95-98	RA1-5	F R	RCK006.02	4	FM4-C	282X23	26	163	88	
ODYSSEY JAPAN MODEL	94-03	RA1-9	F R	RCK006.02	4	FM4-C	282X23	26	163	88	
PRELUDE (S, SE, Si)	92-96	BB2	F R	RCK006.07	4	FM4-C	282X23	26	163	88	D
PRELUDE (V-TEC)	92-96	BB1	F R	RCK006.04	4	FM4-C	282X23	26	163	88	
PRELUDE (ALL MODEL)	97-01	BB5/6/7	F R	RCK006.06	4	FM4-C	282X23	26	163	88	
S2000	00-07	AP1/2	F R	RCK035.01	4	FM4-B	300X25	35	170	98	
<b>INFINITI</b>											
G20	99-02	P11	F R	RCK063.02	4	FM4	280X22	22	163	88	
G37	08	V36	F	RCK073.03	6	FC6	355X32	43	201	122	C
			R	RCK029.01	4	FC4	350X20	8	196	122	C
I30 (CEFIRO)	95-99	A32	F R	RCK063.01	4	FM4	280X22	22	163	88	
<b>LEXUS</b>											
ES 300, 330 (WINDOM)	02-06	MCV30/31	F R	RCK084.02	6	FC6	319X28	39	187	113	C, D
ES 350 (WINDOM)	07	GSV40	F R	RCK084.02	6	FC6	319X28	39	187	113	C, D
RX 300 (HARRIER)	98-03	MCU10/15	F R	RCK084.02	6	FC6	319X28	39	187	113	C, D
RX 330, 350, 400H (HARRIER)	04-08	MCU33/38 GSU35; MHU38	F	RCK084.01	6	FC6	319X28	39	187	113	C
			R								

# CALIPER KIT

MAKE/MODEL	YEAR	CHASSIS	AXLE	PART #	CALIPER		DISC	WHEEL CHART			NOTES
					PISTON	TYPE		SIZE(MM)	A (MM)	B (MM)	
<b>MAZDA</b>											
MIATA MX-5 (NORMAL SUSPENSION)	89-05	NA8C, 6CE	F R	RCK023.01	4	FM4-A	269.5X22	25	159	83	D
MIATA MX-5 (SPORT, HARD SUSPENSION)	01-05	NB8C	F R	RCK023.02	4	FM4-A	269.5X22	25	159	83	
MIATA MX-5 (MAZDASPEED TURBO)	04-05	NB8C	F R	RCK023.02	4	FM4-A	269.5X22	25	159	83	
3 (AXELA); 2000cc ENG, EXC MAZDASPEED 3	04-07	BK3P	F R	RCK069.02	4	FC4	300X25	26	176	98	C, D
3 (AXELA); 2300cc ENG, EXC MAZDASPEED 3	04-07	BK3P	F R	RCK069.01	4	FC4	300X25	26	176	98	C
5 (PREMACY)	06-07	BK3P	F R	RCK069.01	4	FC4	300X25	26	176	98	C
<b>MINI</b>											
COOPER, COOPER-S	02-06	RAVRE16	F R	RCK055.01	4	FM4-A	276X22	27	161	86	
<b>NISSAN</b>											
ALTIMA	93-01	U13, L30	F R	RCK063.02	4	FM4	280X22	22	163	88	
MAXIMA	9/89-3/99	A32	F R	RCK063.01	4	FM4	280X22	22	163	88	
SENTRA (1.8L)	00-06	B15	F R	RCK063.03	4	FM4	280X22	22	163	88	D
SENTRA (2.0L, 2.5L) EXC SPEC V	00-06	B15	F R	RCK063.02	4	FM4	280X22	22	163	88	
<b>OPEL</b>											
OPEL GT EUROPE MODEL	07		F R	RCK156.01	4	FC4	296X26.2	32	174	96	
<b>PONTIAC</b>											
SOLSTICE	06-07		F R	RCK156.01	4	FC4	296X26.2	32	174	96	
<b>SAAB</b>											
9-2X 2.5L (LINEAR)	05-06	GDA	F R	RCK011.03	4	FM4	276.8X24	15	162	87	
9-2X 2.0L TURBO (AERO)	05-06	GDA	F R	RCK011.01	4	FM4	293.5X24	15	168	95	
<b>SATURN</b>											
SKY	06		F R	RCK156.01	4	FC4	296X26.2	32	174	96	
<b>SUBARU</b>											
BAJA	03-05	B12	F R	RCK011.01	4	FM4	293.5X24	15	168	95	
FORESTER	98-02	SF5	F R	RCK011.02	4	FM4	276.8X24	15	162	87	
FORESTER	03-07	SG5	F R	RCK011.01	4	FM4	293.5X24	15	168	95	
IMPREZA	11/92-01	GC6/8	F R	RCK011.04	4	FM4	276.8X24	15	162	87	D
IMPREZA 2.5RS	98-01	GC8	F R	RCK011.02	4	FM4	276.8X24	15	162	87	
IMPREZA 2.5RS	02-07	GDA/B, GGA	F R	RCK011.03	4	FM4	276.8X24	15	162	87	
IMPREZA OUTBACK	95-01	GC6/8	F	RCK011.04	4	FM4	276.8X24	15	162	87	D

# CALIPER KIT

MAKE/MODEL	YEAR	CHASSIS	AXLE	PART #	CALIPER		DISC SIZE(MM)	WHEEL CHART			NOTES
			F/R		PISTON	TYPE		A (MM)	B (MM)	C (MM)	
IMPREZA OUTBACK	02-07	GDA	R F R	RCK011.03	4	FM4	276.8X24	15	162	87	
IMPREZA WRX	02-07	GDA/B: GGA	F R	RCK011.01	4	FM4	293.5X24	15	168	95	
LEGACY L	90-99	BD/BG5	F R	RCK011.04	4	FM4	276.8X24	15	162	87	D
LEGACY GT, LSi, LS, LTD	90-99	BD/BG5	F R	RCK011.02	4	FM4	276.8X24	15	162	87	
LEGACY L, L-S	00-04	BH/BL/BP5	F R	RCK011.03	4	FM4	276.8X24	15	162	87	
LEGACY GT, LTD	00-04	BH/BL/BP5	F R	RCK011.01	4	FM4	293.5X24	15	168	95	
LEGACY 2.5i (EXC 2.5 GT)	05	BH/BL/BP5	F R	RCK011.03	4	FM4	276.8X24	15	162	87	
OUTBACK	00	GDA	F R	RCK011.03	4	FM4	276.8X24	15	162	87	
OUTBACK (EXC TURBO)	01-05	GDA	F R	RCK011.01	4	FM4	293.5X24	15	168	95	
<b>TOYOTA</b>											
ALPHARD JAPAN MODEL	02-	ANH10/15W MNH10/15W	F R	RCK084.02	6	FC6	319X28	39	187	113	C, D
AVALON	05-07	G SX30	F R	RCK084.02	6	FC6	319X28	39	187	113	C, D
CAMRY	02-06	ACV/MCV30 MCV31	F R	RCK084.02	6	FC6	319X28	39	187	113	C, D
CAMRY	07	AHV/ACV40	F R	RCK084.02	6	FC6	319X28	39	187	113	C, D
ESTIMA JAPAN MODEL	00-	ACR30/40W MCR30/40W	F R	RCK084.02	6	FC6	319X28	39	187	113	C, D
HIGHLANDER (KLUGER)	01-03	ACU20/25 MCU20/25	F R	RCK084.02	6	FC6	319X28	39	187	113	C, D
HIGHLANDER (KLUGER); EXC HYBRID	04-07	ACU20/25 MCU21/26	F R	RCK084.02	6	FC6	319X28	39	187	113	C, D
HIGHLANDER (KLUGER); HYBRID	06-07	MHU28	F R	RCK084.01	6	FC6	319X28	39	187	113	C
MARK II QUALIS JAPAN MODEL	97-01	SXV20W MVV21W	F F	RCK084.02	6	FC6	319X28	39	187	113	C, D
SIENNA	04-07	MCL20/25	F R	RCK084.02	6	FC6	319X28	39	187	113	C, D
SOLARA	04-07	MCV31	F R	RCK084.02	6	FC6	319X28	39	187	113	C, D
SUPRA	86-93	MA70	F R	RCK194.01	4	FM4	276X22	17	171	99	C
<b>VOLVO</b>											
C30	07		F R	RCK161.01	4	FC4	300X25	26	176	98	C
C70	06-07		F R	RCK161.01	4	FC4	300X25	26	176	98	C
S40 (2.4i)	05-07		F R	RCK161.01	4	FC4	300X25	26	176	98	C
V50 (2.4i)	05-07		F R	RCK161.01	4	FC4	300X25	26	176	98	C

## NOTES:

A=SPECIAL ORDER ONLY (LEAD TIME 60-90 DAYS DEPENDING ON APPLICATION)

B=(RACE ONLY) WITHOUT E-BRAKE

C=NEW (CONTACT ROTORA FOR AVAILABILITY)

D=LARGER STOCK MODEL DIAMETER BRAKE DISCS MUST BE UPGRADED WHEN USING THIS KIT (PLEASE CALL ROTORA FOR FURTHER ASSISTANCE)

E=ONE SET OF FRONT MODIFIED O.E KNUCKLE WILL BE SUPPLIED ALONG WITH A CORE CHARGE OF \$400.00USD

F=FOR REAR DISC MODELS ONLY (NOT REAR DRUM TO BRAKE DISC CONVERSION)

G=REAR STAINLESS STEEL BRAIDED BRAKE LINES NOT INCLUDED (REAR BRAKE SYSTEM UTILIZES ORIGINAL BRAKE LINE)

## PART NUMBER INFORMATION:

ADD LETTER TO THE END OF THE PART# TO INDICATE CALIPER COLOR (A=RED OR M=METALLIC BLUE). EXAMPLE: RCK011.01M

CUSTOM CALIPER COLOR INCLUDE (B=DARK BLUE, C=CHROME, D=GUNMETAL, E=GOLD, F=SILVER, G=BLACK, K=ORANGE, Y=YELLOW)

# CALIPER KIT

MAKE/MODEL	YEAR	CHASSIS	AXLE	PART #	CALIPER		DISC	WHEEL CHART			NOTES
					PISTON	TYPE	SIZE(MM)	A (MM)	B (MM)	C (MM)	
			F/R								

CUSTOM CALIPER COLOR INCLUDE (B=DARK BLUE, C=CHROME, D=GUNMETAL, E=GOLD, F=SILVER, G=BLACK, Y=YELLOW)

**GENERAL INFORMATION:**

LEFT: DRIVER SIDE, RIGHT: PASSENGER SIDE (NORTH AMERICA)

UNLESS OTHERWISE SPECIFIED, ALL BRAKE SYSTEMS ARE FOR NORTH AMERICAN VEHICLES

ROTORA BRAKE SYSTEM MAY REQUIRE MINOR MODIFICATION OR REMOVAL OF THE OEM DUST COVER SHIELD/BACKING PLATE

**CALIPER KIT STANDARD COMPONENTS: (PER AXLE)**

A SET OF PRE-INSTALLED BILLET CALIPERS

A SET OF STAINLESS STEEL BRAIDED BRAKE LINES (DOT COMPLIANT)

A SET OF T-BILLET 7075 GRADE MOUNTING BRACKETS (DEPENDING ON APPLICATION)

A SET OF H2 CERAMIC FORMULATED PADS

OPTIONAL: HIGHER CERAMIC PAD GRADES AVAILABLE (PLEASE CALL ROTORA FOR FURTHER ASSISTANCE IN PAD GRADE SELECTION)

OPTIONAL: 1-PIECE SYSTEM (SLOTTED OR DRILLED & SLOTTED) VENTED DISCS

# SERVICE PART

TYPE	DESCRIPTION	SIDE	PART #	NOTES
		L/R		
<b>BRAKE DISC &amp; DISC RING</b>				
PRICES ARE PER SINGLE DISC. BRAKE DISC ASSEMBLY KIT INCLUDED FOR ALL 2-PIECE DISC. T-BILLET MOUNTING HAT NOT INCLUDED.				
1-PIECE DISC	ALL 290X18MM DIAMETER DISC (SLOTTED)	L R	CALL CALL	
1-PIECE DISC	ALL 290X18MM DIAMETER DISC (DRILLED & SLOTTED)	L R	CALL CALL	
1-PIECE DISC	ALL 295MM DIAMETER DISC (SLOTTED)	L R	CALL CALL	
1-PIECE DISC	ALL 295MM DIAMETER DISC (DRILLED & SLOTTED)	L R	CALL CALL	
1-PIECE DISC	ALL 330MM DIAMETER DISC (SLOTTED)	L R	CALL CALL	
1-PIECE DISC	ALL 330MM DIAMETER DISC (DRILLED & SLOTTED)	L R	CALL CALL	
2-PIECE DISC	282X25MM; 44 VANE; 11.5MM AIR GAP; 8 BOLT; (SLOTTED)	L R	RR.282.1S RR.282.2S	
2-PIECE DISC	282X25MM; 44 VANE; 11.5 AIRMM GAP; 8 BOLT; (DRILLED & SLOTTED)	L R	RR.282.1C RR.282.2C	
2-PIECE DISC	330X30MM; 40 VANE; 17MM AIR GAP; 10 BOLT; (SLOTTED)	L R	RR.330.1S RR.330.2S	
2-PIECE DISC	330X30MM; 40 VANE; 17MM AIR GAP; 10 BOLT; (DRILLED & SLOTTED)	L R	RR.330.1C RR.330.2C	
2-PIECE DISC	330X30MM; 40 VANE; 17MM AIR GAP; 10 BOLT; (SLOTTED); REAR DRUM=190MM DIA.	L R	RR.330.D.1S RR.330.D.2S	
2-PIECE DISC	330X30MM; 40 VANE; 17MM AIR GAP; 10 BOLT; (DRILLED & SLOTTED); REAR DRUM=190MM DIA.	L R	RR.330.D.1C RR.330.D.2C	
2-PIECE DISC	355X32MM; 48 VANE; 17MM AIR GAP; 10 BOLT; (SLOTTED)	L R	RR.355.1S RR.355.2S	
2-PIECE DISC	355X32MM; 48 VANE; 17MM AIR GAP; 10 BOLT; (DRILLED & SLOTTED)	L R	RR.355.1C RR.355.2C	
2-PIECE DISC	380X34MM; 72 VANE; 18MM AIR GAP; 12 BOLT; (SLOTTED)	L R	RR.380.1S RR.380.2S	
2-PIECE DISC	380X34MM; 72 VANE; 18MM AIR GAP; 12 BOLT; (DRILLED & SLOTTED)	L R	RR.380.1C RR.380.2C	
2-PIECE DISC	405X36MM; 72 VANE; 18MM AIR GAP; 12 BOLT; (SLOTTED)	L R	RR.405.1S RR.405.2S	
2-PIECE DISC	405X36MM; 72 VANE; 18MM AIR GAP; 12 BOLT; (DRILLED & SLOTTED)	L R	RR.405.1C RR.405.2C	
<b>BRAKE DISC ASSEMBLY KIT</b>				
PRICES ARE PER SINGLE PIN WITH HARDWARE.				
DISC ASSEMBLY KIT	FLANGE BUSHING, SCREW & WASHER 282MM DISCS (8 PINS PER DISC); 330MM AND 355MM DISCS (10 PINS PER DISC)		MK06.1	
DISC ASSEMBLY KIT	FLANGE BUSHING, SCREW & WASHER 380MM AND 405MM DISCS (12 PINS PER DISC)		MK08.2	
<b>BRAKE DISC T-BILLET HAT</b>				
T-BILLET 7075 FORGED GRADE. PRICES ARE PER T-BILLET HAT. BRAKE DISC ASSEMBLY KIT NOT INCLUDED. PLEASE CONTACT ROTORA FOR VEHICLE TYPE AND PART NO.				
ALUMINUM HAT	282X25MM (11.1") FRONT/REAR DISC		CALL	
ALUMINUM HAT	330X30MM (13") FRONT DISC		CALL	
ALUMINUM HAT	330X30MM (13") REAR DISC		CALL	
ALUMINUM HAT	355X32MM (14") FRONT DISC		CALL	
ALUMINUM HAT	355X32MM (14") REAR DISC		CALL	
ALUMINUM HAT	380X34MM (15") FRONT DISC		CALL	
ALUMINUM HAT	380X34MM (15") REAR DISC		CALL	
ALUMINUM HAT	405X36MM (16") FRONT DISC		CALL	
ALUMINUM HAT	405X36MM (16") REAR DISC		CALL	
<b>CALIPER</b>				

# SERVICE PART

TYPE	DESCRIPTION	SIDE	PART #	NOTES
		L/R		
PRICES ARE PER FORGED CALIPER. PISTONS, PRESSURE SEALS AND DUST BOOTS INCLUDED. PADS AND BRACKETS NOT INCLUDED. PLEASE CONTACT ROTORA FOR VEHICLE TYPE AND PART NO.				
2-PISTON	FC2-A CALIPER SERIES; INTEGRAL BRACKET		CALL	
2-PISTON	FC2 CALIPER SERIES		CALL	
4-PISTON	FM4-A/B/C CALIPER SERIES; INTEGRAL BRACKET		CALL	
4-PISTON	FM4 CALIPER SERIES		CALL	
4-PISTON	FC4-A/B CALIPER SERIES; INTEGRAL BRACKET		CALL	
4-PISTON	FC4 CALIPER SERIES		CALL	
4-PISTON	FF4 CALIPER SERIES		CALL	
6-PISTON	FM6 CALIPER SERIES		CALL	
6-PISTON	FC6 CALIPER SERIES		CALL	
8-PISTON	FC8 CALIPER SERIES		CALL	
12-PISTON	FC12 CALIPER SERIES		CALL	

## CALIPER HARDWARE

PRICES ARE PER SINGLE SIDE CALIPER SET UNLESS OTHERWISE SPECIFIED.				
BLEEDER KIT	2 BLEEDER SCREWS, 2 WASHER SEALS, 2 DUST CAPS		SPC.1	
BRIDGE RETAINING CLIP	FC2 CALIPER SERIES (2-PISTON)		SPC.A.20	
BRIDGE RETAINING CLIP	FM4 CALIPER SERIES (4-PISTON)		SPC.A.40	
BRIDGE RETAINING CLIP	FC4 CALIPER SERIES (4-PISTON)		SPC.A.41	
BRIDGE RETAINING CLIP	FF4 CALIPER SERIES (4-PISTON)		SPC.A.42	
BRIDGE RETAINING CLIP	FM6 CALIPER SERIES (6-PISTON)		SPC.A.60	
BRIDGE RETAINING CLIP	FC6 CALIPER SERIES (6-PISTON)		SPC.A.61	
BRIDGE RETAINING CLIP	FC8 CALIPER SERIES (8-PISTON); 2 PER SINGLE CALIPER		SPC.A.80	
BRIDGE RETAINING CLIP	FC12 CALIPER SERIES (8-PISTON); 3 PER SINGLE CALIPER		SPC.A.120	
BRIDGE BOLT/PIN	FF4 CALIPER SERIES (4-PISTON)		SPC.B.40	
BRIDGE BOLT/PIN	FM6 CALIPER SERIES (6-PISTON)		SPC.B.60	
BRIDGE BOLT/PIN	FC6 CALIPER SERIES (6-PISTON)		SPC.B.61	
BRIDGE BOLT/PIN	FC8 CALIPER SERIES (8-PISTON); 2 PER SINGLE CALIPER		SPC.B.80	
BRIDGE BOLT/PIN	FC12 CALIPER SERIES (8-PISTON); 3 PER SINGLE CALIPER		SPC.B.120	
CALIPER BOLT	CALIPER BODY & CALIPER MOUNTING BOLT; 1 EACH		CALL	
CROSS OVER TUBE	FC2 CALIPER SERIES (2-PISTON)		SPC.C.20	
CROSS OVER TUBE	FM4 CALIPER SERIES (4-PISTON)		SPC.C.40	
CROSS OVER TUBE	FC4 CALIPER SERIES (4-PISTON)		SPC.C.41	
CROSS OVER TUBE	FF4 CALIPER SERIES (4-PISTON)		SPC.C.42	
CROSS OVER TUBE	FM6 CALIPER SERIES (6-PISTON)		SPC.C.60	
CROSS OVER TUBE	FC6 CALIPER SERIES (6-PISTON)		SPC.C.61	



# SERVICE PART

TYPE	DESCRIPTION	SIDE	PART #	NOTES
		L/R		
CROSS OVER TUBE	FC8 CALIPER SERIES (8-PISTON); 2 PER SINGLE CALIPER		SPC.C.80	
CROSS OVER TUBE	FC12 CALIPER SERIES (12-PISTON); 3 PER SINGLE CALIPER		SPC.C.120	
PAD PIN & COTTER CLIP	FC2 CALIPER SERIES (2-PISTON)		SPC.F.20	
PAD PIN & COTTER CLIP	FM4 CALIPER SERIES (4-PISTON)		SPC.F.40	
PAD PIN & COTTER CLIP	FC4 CALIPER SERIES (4-PISTON)		SPC.F.41	
PAD PIN & COTTER CLIP	FC6 CALIPER SERIES (6-PISTON)		SPC.F.60	
PISTON SEAL	27MM; 1 PRESSURE SEAL, 1 DUST BOOT		SPC.D.27	
PISTON SEAL	30.23MM; 1 PRESSURE SEAL, 1 DUST BOOT		SPC.D.30.23	
PISTON SEAL	32MM; 1 PRESSURE SEAL, 1 DUST BOOT		SPC.D.32	
PISTON SEAL	33.96MM; 1 PRESSURE SEAL, 1 DUST BOOT		SPC.D.33.96	
PISTON SEAL	34.93MM; 1 PRESSURE SEAL, 1 DUST BOOT		SPC.D.34.93	
PISTON SEAL	38.18MM; 1 PRESSURE SEAL, 1 DUST BOOT		SPC.D.38.18	
PISTON SEAL	40.45MM; 1 PRESSURE SEAL, 1 DUST BOOT		SPC.D.40.45	
PISTON SEAL	42.85MM; 1 PRESSURE SEAL, 1 DUST BOOT		SPC.D.42.85	
PISTON SEAL	44.5MM; 1 PRESSURE SEAL, 1 DUST BOOT		SPC.D.44.5	
PISTON	27MM PISTON; SINGLE		SPC.E.27	
PISTON	30.23MM PISTON; SINGLE		SPC.E.30.23	
PISTON	32MM PISTON; SINGLE		SPC.E.32	
PISTON	33.96MM PISTON; SINGLE		SPC.E.33.96	
PISTON	34.93MM PISTON; SINGLE		SPC.E.34.93	
PISTON	38.18MM PISTON; SINGLE		SPC.E.38.18	
PISTON	40.45MM PISTON; SINGLE		SPC.E.40.45	
PISTON	42.85MM PISTON; SINGLE		SPC.E.42.85	
PISTON	44.5MM PISTON; SINGLE		SPC.E.44.5	
<b>CALIPER MOUNTING BRACKET</b>				
T-BILLET 7075 FORGED GRADE. PRICES ARE PER SINGLE BRACKET. CALIPER MOUNTING BOLTS NOT INCLUDED. PLEASE CONTACT ROTORA FOR VEHICLE TYPE AND PART NO.				
BRACKET	FC2 CALIPER SERIES (2-PISTON)		CALL	
BRACKET	FM4 CALIPER SERIES (4-PISTON)		CALL	
BRACKET	FC4 CALIPER SERIES; (4-PISTON) W/ 330MM OR 355MM DISCS		CALL	
BRACKET	FF4 CALIPER SERIES; (4-PISTON) W/ 330MM, 355MM, OR 380MM DISCS		CALL	
BRACKET	FM6 CALIPER SERIES; (6-PISTON) W/ 282MM OR 330MM DISCS		CALL	
BRACKET	FC6 CALIPER SERIES; (6-PISTON) W/ 330MM OR 355MM DISCS		CALL	
BRACKET	FC8 CALIPER SERIES; (8-PISTON) W/ 380MM OR 405MM DISCS		CALL	
BRACKET	FC12 CALIPER SERIES; (12-PISTON) W/ 380MM OR 405MM DISCS		CALL	

# SERVICE PART

TYPE	DESCRIPTION	SIDE	PART #	NOTES
		L/R		
<b>PAD</b>				
PRICES ARE PER AXLE SET.				
2-PISTON PAD	FC2 CALIPER SERIES H2 CERAMIC (STREET/LIGHT TRACK)		RP.02.1	
2-PISTON PAD	FC2 CALIPER SERIES H6 HIGH-CERAMIC (TRACK/RACE)		RP.02.2	
2-PISTON PAD	FC2 CALIPER SERIES H8 CERAMIC-METALLIC (RACE/ENDURANCE)		RP.02.3	
4-PISTON PAD	FM4 CALIPER SERIES H2 CERAMIC (STREET/LIGHT TRACK)		RP.4M.1	
4-PISTON PAD	FM4 CALIPER SERIES H6 HIGH-CERAMIC (TRACK/RACE)		RP.4M.2	
4-PISTON PAD	FM4 CALIPER SERIES H8 CERAMIC-METALLIC (RACE/ENDURANCE)		RP.4M.3	
4-PISTON PAD	FC4 CALIPER SERIES H2 CERAMIC (STREET/LIGHT TRACK)		RP.04.1	
4-PISTON PAD	FC4 CALIPER SERIES H6 HIGH-CERAMIC (TRACK/RACE)		RP.04.2	
4-PISTON PAD	FC4 CALIPER SERIES H8 CERAMIC-METALLIC (RACE/ENDURANCE)		RP.04.3	
4-PISTON PAD	FF4 CALIPER SERIES H2 CERAMIC (STREET/LIGHT TRACK)		RP.4N.1	
4-PISTON PAD	FF4 CALIPER SERIES H6 HIGH-CERAMIC (TRACK/RACE)		RP.4N.2	
4-PISTON PAD	FF4 CALIPER SERIES H8 CERAMIC-METALLIC (RACE/ENDURANCE)		RP.4N.3	
6-PISTON PAD	FM6 CALIPER SERIES H2 CERAMIC (STREET/LIGHT TRACK)		RP.6M.1	
6-PISTON PAD	FM6 CALIPER SERIES H6 HIGH-CERAMIC (TRACK/RACE)		RP.6M.2	
6-PISTON PAD	FM6 CALIPER SERIES H8 CERAMIC-METALLIC (RACE/ENDURANCE)		RP.6M.3	
6-PISTON PAD	FC6 CALIPER SERIES H2 CERAMIC (STREET/LIGHT TRACK)		RP.06.1	
6-PISTON PAD	FC6 CALIPER SERIES H6 HIGH-CERAMIC (TRACK/RACE)		RP.06.2	
6-PISTON PAD	FC6 CALIPER SERIES H8 CERAMIC-METALLIC (RACE/ENDURANCE)		RP.06.3	
8-PISTON PAD	FC8 CALIPER SERIES H2 CERAMIC (STREET/LIGHT TRACK)		RP.08.1	
8-PISTON PAD	FC8 CALIPER SERIES H6 HIGH-CERAMIC (TRACK/RACE)		RP.08.2	
8-PISTON PAD	FC8 CALIPER SERIES H8 CERAMIC-METALLIC (RACE/ENDURANCE)		RP.08.3	
12-PISTON PAD	FC12 CALIPER SERIES H2 CERAMIC (STREET/LIGHT TRACK)		RP.12.1	
12-PISTON PAD	FC12 CALIPER SERIES H6 HIGH-CERAMIC (TRACK/RACE)		RP.12.2	
12-PISTON PAD	FC12 CALIPER SERIES H8 CERAMIC-METALLIC (RACE/ENDURANCE)		RP.12.3	
<b>STAINLESS STEEL BRAKE LINE &amp; FITTING</b>				
PRICES ARE PER AXLE SET. PLEASE CONTACT ROTORA FOR VEHICLE TYPE AND PART NO.				
STAINLESS STEEL BRAKE LINE	FITTINGS, HOSES, AND HARDWARE		CALL	
BANJO BOLT KIT	2 BANJO BOLTS, 4 CRUSH COPPER WASHERS		SPL.1	

**NOTES:**

A-SPECIAL ORDER (PLEASE CALL FOR AVAILABILITY)

**GENERAL INFORMATION:**

"L"=LEFT SIDE: DRIVER SIDE, "R"=RIGHT SIDE: PASSENGER SIDE (NORTH AMERICA)

BRAKE DISC		BASIC OEM		SLOTTED		DRILLED & SLOTTED		NOTES
MAKE/MODEL	AXLE	PART #		PART #		PART #		
YEAR	F/R	LEFT	RIGHT	LEFT	RIGHT	LEFT	RIGHT	
<b>ACURA</b>								
<b>CL COUPE</b>								
97	2.2L (4 CYL.)	F	R.40022	R.40022	R.40022.1S	R.40022.2S	R.40022.1C	R.40022.2C
		R	R.40024	R.40024	R.40024.1S	R.40024.2S	R.40024.1C	R.40024.2C
97	3.0L (V6)	F	R.40025	R.40025	R.40025.1S	R.40025.2S	R.40025.1C	R.40025.2C
		R	R.40024	R.40024	R.40024.1S	R.40024.2S	R.40024.1C	R.40024.2C
98-99	2.3L (4 CYL.)	F	R.40039	R.40039	R.40039.1S	R.40039.2S	R.40039.1C	R.40039.2C
		R	R.40041	R.40041	R.40041.1S	R.40041.2S	R.40041.1C	R.40041.2C
98-99	3.0L (V6)	F	R.40037	R.40037	R.40037.1S	R.40037.2S	R.40037.1C	R.40037.2C
		R	R.40041	R.40041	R.40041.1S	R.40041.2S	R.40041.1C	R.40041.2C
01-03	3.2L (V6)	F	R.40046	R.40046	R.40046.1S	R.40046.2S	R.40046.1C	R.40046.2C
		R	R.40052	R.40052	R.40052.1S	R.40052.2S	R.40052.1C	R.40052.2C
<b>CSX (CANADA)</b>								
06		F	R.40036	R.40036	R.40036.1S	R.40036.2S	R.40036.1C	R.40036.2C
		R	R.40040	R.40040	R.40040.1S	R.40040.2S	R.40040.1C	R.40040.2C
06-07	CSX (2.0L)	F	R.40036	R.40036	R.40036.1S	R.40036.2S	R.40036.1C	R.40036.2C
		R	R.40040	R.40040	R.40040.1S	R.40040.2S	R.40040.1C	R.40040.2C
06-07	CSX TYPE-S (2.0L)	F	R.40057	R.40057	R.40057.1S	R.40057.2S	R.40057.1C	R.40057.2C
		R	R.40040	R.40040	R.40040.1S	R.40040.2S	R.40040.1C	R.40040.2C
<b>EL (CANADA)</b>								
97-00		F	R.40021	R.40021	R.40021.1S	R.40021.2S	R.40021.1C	R.40021.2C
		R						
01-05		F	R.40021	R.40021	R.40021.1S	R.40021.2S	R.40021.1C	R.40021.2C
		R	R.40060	R.40060	R.40060.1S	R.40060.2S	R.40060.1C	R.40060.2C
06		F	R.40046	R.40046	R.40046.1S	R.40046.2S	R.40046.1C	R.40046.2C
		R	R.40055	R.40055	R.40055.1S	R.40055.2S	R.40055.1C	R.40055.2C
<b>INTEGRA</b>								
86-89		F	R.40013	R.40013	R.40013.1S	R.40013.2S	R.40013.1C	R.40013.2C
		R	R.40014	R.40014	R.40014.1S	R.40014.2S	R.40014.1C	R.40014.2C
90-96		F	R.40021	R.40021	R.40021.1S	R.40021.2S	R.40021.1C	R.40021.2C
		R	R.40017	R.40017	R.40017.1S	R.40017.2S	R.40017.1C	R.40017.2C
97-01	EXC TYPE R	F	R.40021	R.40021	R.40021.1S	R.40021.2S	R.40021.1C	R.40021.2C
		R	R.40017	R.40017	R.40017.1S	R.40017.2S	R.40017.1C	R.40017.2C
97-01	TYPE R	F	R.40026	R.40026	R.40026.1S	R.40026.2S	R.40026.1C	R.40026.2C
		R	R.40042	R.40042	R.40042.1S	R.40042.2S	R.40042.1C	R.40042.2C
<b>LEGEND</b>								
89-90	COUPE, SEDAN	F	R.40020	R.40020	R.40020.1S	R.40020.2S	R.40020.1C	R.40020.2C
		R	R.40019	R.40019	R.40019.1S	R.40019.2S	R.40019.1C	R.40019.2C
91-92		F	R.40026	R.40026	R.40026.1S	R.40026.2S	R.40026.1C	R.40026.2C
		R	R.40027	R.40027	R.40027.1S	R.40027.2S	R.40027.1C	R.40027.2C
93-95	COUPE	F	R.40033	R.40033	R.40033.1S	R.40033.2S	R.40033.1C	R.40033.2C
		R	R.40027	R.40027	R.40027.1S	R.40027.2S	R.40027.1C	R.40027.2C
93-95	SEDAN (EXC GS)	F	R.40026	R.40026	R.40026.1S	R.40026.2S	R.40026.1C	R.40026.2C
		R	R.40027	R.40027	R.40027.1S	R.40027.2S	R.40027.1C	R.40027.2C
94-95	SEDAN GS	F	R.40033	R.40033	R.40033.1S	R.40033.2S	R.40033.1C	R.40033.2C
		R	R.40027	R.40027	R.40027.1S	R.40027.2S	R.40027.1C	R.40027.2C
<b>MDX</b>								
01-06		F	R.40046	R.40046	R.40046.1S	R.40046.2S	R.40046.1C	R.40046.2C
		R	R.40053	R.40053	R.40053.1S	R.40053.2S	R.40053.1C	R.40053.2C
07		F	R.40071	R.40071	R.40071.1S	R.40071.2S	R.40071.1C	R.40071.2C
		R	R.40072	R.40072	R.40072.1S	R.40072.2S	R.40072.1C	R.40072.2C
<b>NSX</b>								
91-96		F	R.40028	R.40028	R.40028.1S	R.40028.2S	R.40028.1C	R.40028.2C
		R	R.40029	R.40029	R.40029.1S	R.40029.2S	R.40029.1C	R.40029.2C
<b>RDX</b>								
07		F	R.40073	R.40073	R.40073.1S	R.40073.2S	R.40073.1C	R.40073.2C
		R						
<b>RL</b>								
96-98		F	R.40026	R.40026	R.40026.1S	R.40026.2S	R.40026.1C	R.40026.2C
		R	R.40027	R.40027	R.40027.1S	R.40027.2S	R.40027.1C	R.40027.2C
99-01		F	R.40049	R.40049	R.40049.1S	R.40049.2S	R.40049.1C	R.40049.2C
		R	R.40051	R.40051	R.40051.1S	R.40051.2S	R.40051.1C	R.40051.2C
02-04		F	R.40049	R.40049	R.40049.1S	R.40049.2S	R.40049.1C	R.40049.2C
		R	R.40054	R.40054	R.40054.1S	R.40054.2S	R.40054.1C	R.40054.2C
05-07		F	R.40066	R.40066	R.40066.1S	R.40066.2S	R.40066.1C	R.40066.2C
		R	R.40067	R.40067	R.40067.1S	R.40067.2S	R.40067.1C	R.40067.2C
<b>RSX</b>								
02-06	EXC TYPE-S	F	R.40056	R.40056	R.40056.1S	R.40056.2S	R.40056.1C	R.40056.2C

BRAKE DISC		BASIC OEM		SLOTTED		DRILLED & SLOTTED		NOTES	
		AXLE	PART #		PART #		PART #		
MAKE/MODEL	YEAR	F/R	LEFT	RIGHT	LEFT	RIGHT	LEFT	RIGHT	
		R	R.40042	R.40042	R.40042.1S	R.40042.2S	R.40042.1C	R.40042.2C	
02-06	TYPE-S	F	R.40057	R.40057	R.40057.1S	R.40057.2S	R.40057.1C	R.40057.2C	
		R	R.40042	R.40042	R.40042.1S	R.40042.2S	R.40042.1C	R.40042.2C	
<b>SLX</b>									
96-99		F	R.43013	R.43013	R.43013.1S	R.43013.2S	R.43013.1C	R.43013.2C	
		R	R.43015	R.43015	R.43015.1S	R.43015.2S	R.43015.1C	R.43015.2C	
<b>TL</b>									
95-98	2.5L	F	R.40030	R.40030	R.40030.1S	R.40030.2S	R.40030.1C	R.40030.2C	
		R	R.40035	R.40035	R.40035.1S	R.40035.2S	R.40035.1C	R.40035.2C	
96-98	3.2L	F	R.40026	R.40026	R.40026.1S	R.40026.2S	R.40026.1C	R.40026.2C	
		R	R.40045	R.40045	R.40045.1S	R.40045.2S	R.40045.1C	R.40045.2C	
99-03		F	R.40046	R.40046	R.40046.1S	R.40046.2S	R.40046.1C	R.40046.2C	
		R	R.40047	R.40047	R.40047.1S	R.40047.2S	R.40047.1C	R.40047.2C	
04-07	EXC BREMBO CALIPER	F	R.40046	R.40046	R.40046.1S	R.40046.2S	R.40046.1C	R.40046.2C	
		R	R.40061	R.40061	R.40061.1S	R.40061.2S	R.40061.1C	R.40061.2C	
04-07	W/ BREMBO CALIPER	F	R.40062	R.40062	R.40062.1S	R.40062.2S	R.40062.1C	R.40062.2C	c
		R	R.40061	R.40061	R.40061.1S	R.40061.2S	R.40061.1C	R.40061.2C	
<b>TSX</b>									
04-07		F	R.40046	R.40046	R.40046.1S	R.40046.2S	R.40046.1C	R.40046.2C	
		R	R.40055	R.40055	R.40055.1S	R.40055.2S	R.40055.1C	R.40055.2C	
<b>VIGOR</b>									
92-94		F	R.40030	R.40030	R.40030.1S	R.40030.2S	R.40030.1C	R.40030.2C	
		R	R.40031	R.40031	R.40031.1S	R.40031.2S	R.40031.1C	R.40031.2C	
<b>AM GENERAL</b>									
<b>HUMMER H1 (FROM 2003, SEE HUMMER)</b>									
92-03	EXC 12100 LBS. GVW	F	R.67033	R.67033	R.67033.1S	R.67033.2S	R.67033.1C	R.67033.2C	
		R	R.67033	R.67033	R.67033.1S	R.67033.2S	R.67033.1C	R.67033.2C	
<b>AUDI</b>									
<b>ALLROAD</b>									
01-03		F	R.33066	R.33066	R.33066.1S	R.33066.2S	R.33066.1C	R.33066.2C	
		R	R.33064	R.33064	R.33064.1S	R.33064.2S	R.33064.1C	R.33064.2C	
04-06	2.7L (V6)	F	R.33066	R.33066	R.33066.1S	R.33066.2S	R.33066.1C	R.33066.2C	
		R	R.33064	R.33064	R.33064.1S	R.33064.2S	R.33064.1C	R.33064.2C	
04-06	4.2L (V8)	F	R.33066	R.33066	R.33066.1S	R.33066.2S	R.33066.1C	R.33066.2C	
		R	R.33089	R.33089	R.33089.1S	R.33089.2S	R.33089.1C	R.33089.2C	
<b>A3</b>									
06-08		F	R.33098	R.33098	R.33098.1S	R.33098.2S	R.33098.1C	R.33098.2C	c
		R	R.33099	R.33099	R.33099.1S	R.33099.2S	R.33099.1C	R.33099.2C	c
<b>A4, A4 QUATTRO</b>									
96-01		F	R.33039	R.33039	R.33039.1S	R.33039.2S	R.33039.1C	R.33039.2C	
		R	R.33048	R.33048	R.33048.1S	R.33048.2S	R.33048.1C	R.33048.2C	
02-7/04	1.8L TURBO	F	R.33039	R.33039	R.33039.1S	R.33039.2S	R.33039.1C	R.33039.2C	
		R	R.33106	R.33106	R.33106.1S	R.33106.2S	R.33106.1C	R.33106.2C	
02-7/04	3.0L	F	R.33107	R.33107	R.33107.1S	R.33107.2S	R.33107.1C	R.33107.2C	
		R	R.33108	R.33108	R.33108.1S	R.33108.2S	R.33108.1C	R.33108.2C	
8/04-06	1.8L TURBO	F	R.33103	R.33103	R.33103.1S	R.33103.2S	R.33103.1C	R.33103.2C	A
		R	R.33106	R.33106	R.33106.1S	R.33106.2S	R.33106.1C	R.33106.2C	
8/04-06	3.0L	F	R.33107	R.33107	R.33107.1S	R.33107.2S	R.33107.1C	R.33107.2C	
		R	R.33108	R.33108	R.33108.1S	R.33108.2S	R.33108.1C	R.33108.2C	
05-07	2.0L TURBO, 3.2L	F	R.33096	R.33096	R.33096.1S	R.33096.2S	R.33096.1C	R.33096.2C	
		R	R.33097	R.33097	R.33097.1S	R.33097.2S	R.33097.1C	R.33097.2C	
<b>A6 (EXC QUATTRO)</b>									
95-01	15" WHEEL (STD SUSPENSION)	F	R.33039	R.33039	R.33039.1S	R.33039.2S	R.33039.1C	R.33039.2C	
		R	R.33038	R.33038	R.33038.1S	R.33038.2S	R.33038.1C	R.33038.2C	
98-04	16" WHEEL (SPORT SUSPENSION)	F	R.33107	R.33107	R.33107.1S	R.33107.2S	R.33107.1C	R.33107.2C	
		R	R.33038	R.33038	R.33038.1S	R.33038.2S	R.33038.1C	R.33038.2C	
05-07		F	R.33111	R.33111	R.33111.1S	R.33111.2S	R.33111.1C	R.33111.2C	
		R	R.33104	R.33104	R.33104.1S	R.33104.2S	R.33104.1C	R.33104.2C	
<b>A6 QUATTRO</b>									
95-98		F	R.33039	R.33039	R.33039.1S	R.33039.2S	R.33039.1C	R.33039.2C	
		R	R.33038	R.33038	R.33038.1S	R.33038.2S	R.33038.1C	R.33038.2C	
98-01	15" WHEEL (STD SUSPENSION)	F	R.33039	R.33039	R.33039.1S	R.33039.2S	R.33039.1C	R.33039.2C	
		R	R.33058	R.33058	R.33058.1S	R.33058.2S	R.33058.1C	R.33058.2C	
98-01	16" WHEEL (SPORT SUSPENSION)	F	R.33107	R.33107	R.33107.1S	R.33107.2S	R.33107.1C	R.33107.2C	
	AVANT	R	R.33063	R.33063	R.33063.1S	R.33063.2S	R.33063.1C	R.33063.2C	
98-01	16" WHEEL (SPORT SUSPENSION)	F	R.33107	R.33107	R.33107.1S	R.33107.2S	R.33107.1C	R.33107.2C	

BRAKE DISC		BASIC OEM		SLOTTED		DRILLED & SLOTTED		NOTES	
MAKE/MODEL		AXLE	PART #		PART #		PART #		
YEAR		F/R	LEFT	RIGHT	LEFT	RIGHT	LEFT		RIGHT
	SEDAN	R	R.33058	R.33058	R.33058.1S	R.33058.2S	R.33058.1C	R.33058.2C	
98-01	16" WHEEL (W/ 215/55 R16 TIRES)	F	R.33107	R.33107	R.33107.1S	R.33107.2S	R.33107.1C	R.33107.2C	
		R	R.33064	R.33064	R.33064.1S	R.33064.2S	R.33064.1C	R.33064.2C	
6/99-01	2.7L TURBO	F	R.33066	R.33066	R.33066.1S	R.33066.2S	R.33066.1C	R.33066.2C	
		R	R.33064	R.33064	R.33064.1S	R.33064.2S	R.33064.1C	R.33064.2C	
6/99-01	4.2L (V8)	F	R.33065	R.33065	R.33065.1S	R.33065.2S	R.33065.1C	R.33065.2C	
		R	R.33072	R.33072	R.33072.1S	R.33072.2S	R.33072.1C	R.33072.2C	
02-04	3.0L-AVANT	F	R.33066	R.33066	R.33066.1S	R.33066.2S	R.33066.1C	R.33066.2C	
		R	R.33063	R.33063	R.33063.1S	R.33063.2S	R.33063.1C	R.33063.2C	
02-04	3.0L-SEDAN	F	R.33066	R.33066	R.33066.1S	R.33066.2S	R.33066.1C	R.33066.2C	
		R	R.33064	R.33064	R.33064.1S	R.33064.2S	R.33064.1C	R.33064.2C	
02-04	2.7L TURBO (4 PAD FRONT CALIPER)	F	R.33065	R.33065	R.33065.1S	R.33065.2S	R.33065.1C	R.33065.2C	
		R	R.33064	R.33064	R.33064.1S	R.33064.2S	R.33064.1C	R.33064.2C	
02-04	2.7L TURBO (2 PAD FRONT CALIPER)	F	R.33066	R.33066	R.33066.1S	R.33066.2S	R.33066.1C	R.33066.2C	
		R	R.33064	R.33064	R.33064.1S	R.33064.2S	R.33064.1C	R.33064.2C	
02-04	4.2L (V8)	F	R.33065	R.33065	R.33065.1S	R.33065.2S	R.33065.1C	R.33065.2C	
		R	R.33072	R.33072	R.33072.1S	R.33072.2S	R.33072.1C	R.33072.2C	
05-07	3.2L	F	R.33111	R.33111	R.33111.1S	R.33111.2S	R.33111.1C	R.33111.2C	
		R	R.33104	R.33104	R.33104.1S	R.33104.2S	R.33104.1C	R.33104.2C	
05-07	4.2L (V8)	F	R.33100	R.33100	R.33100.1S	R.33100.2S	R.33100.1C	R.33100.2C	
		R	R.33101	R.33101	R.33101.1S	R.33101.2S	R.33101.1C	R.33101.2C	
<b>A8, A8 QUATTRO</b>									
97-8/99		F	R.33107	R.33107	R.33107.1S	R.33107.2S	R.33107.1C	R.33107.2C	
		R	R.33026	R.33026	R.33026.1S	R.33026.2S	R.33026.1C	R.33026.2C	
9/99-03		F	R.33060	R.33060	R.33060.1S	R.33060.2S	R.33060.1C	R.33060.2C	
		R	R.33061	R.33061	R.33061.1S	R.33061.2S	R.33061.1C	R.33061.2C	
04		F	R.33092	R.33092	R.33092.1S	R.33092.2S	R.33092.1C	R.33092.2C	A
		R	R.33102	R.33102	R.33102.1S	R.33102.2S	R.33102.1C	R.33102.2C	A
05-07	3.2L	F	R.33111	R.33111	R.33111.1S	R.33111.2S	R.33111.1C	R.33111.2C	
		R	R.33104	R.33104	R.33104.1S	R.33104.2S	R.33104.1C	R.33104.2C	
05-07	4.2L (V8)	F	R.33100	R.33100	R.33100.1S	R.33100.2S	R.33100.1C	R.33100.2C	
		R	R.33101	R.33101	R.33101.1S	R.33101.2S	R.33101.1C	R.33101.2C	
<b>CABRIOLET (SEE A4 FROM 2002)</b>									
94-98		F	R.33029	R.33029	R.33029.1S	R.33029.2S	R.33029.1C	R.33029.2C	
		R	R.33020	R.33020	R.33020.1S	R.33020.2S	R.33020.1C	R.33020.2C	
<b>Q7</b>									
07-08		F	R.33090	R.33091	R.33090.1S	R.33090.2S	R.33090.1C	R.33090.2C	B
		R	R.33078	R.33078	R.33078.1S	R.33078.2S	R.33078.1C	R.33078.2C	
<b>S4</b>									
92-94		F	R.33040	R.33040	R.33040.1S	R.33040.2S	R.33040.1C	R.33040.2C	
		R	R.33033	R.33033	R.33033.1S	R.33033.2S	R.33033.1C	R.33033.2C	
2/99-02		F	R.33066	R.33066	R.33066.1S	R.33066.2S	R.33066.1C	R.33066.2C	
		R	R.33067	R.33067	R.33066.1S	R.33066.2S	R.33066.1C	R.33066.2C	
04-07		F	R.33087	R.33087	R.33087.1S	R.33087.2S	R.33087.1C	R.33087.2C	A
		R	R.33088	R.33088	R.33088.1S	R.33088.2S	R.33088.1C	R.33088.2C	A
<b>S6</b>									
95-98		F	R.33040	R.33040	R.33040.1S	R.33040.2S	R.33040.1C	R.33040.2C	
		R	R.33033	R.33033	R.33033.1S	R.33033.2S	R.33033.1C	R.33033.2C	
02-04		F	R.33065	R.33065	R.33065.1S	R.33065.2S	R.33065.1C	R.33065.2C	
		R	R.33072	R.33072	R.33072.1S	R.33072.2S	R.33072.1C	R.33072.2C	
<b>S8</b>									
01-03		F	R.33073	R.33073	R.33073.1S	R.33073.2S	R.33073.1C	R.33073.2C	A
		R	R.33056	R.33056	R.33056.1S	R.33056.2S	R.33056.1C	R.33056.2C	A
<b>TT (EXC QUATTRO)</b>									
3/99-06		F	R.33062	R.33062	R.33062.1S	R.33062.2S	R.33062.1C	R.33062.2C	
		R	R.33057	R.33057	R.33057.1S	R.33057.2S	R.33057.1C	R.33057.2C	
08		F	R.33098	R.33098	R.33098.1S	R.33098.2S	R.33098.1C	R.33098.2C	C
		R							
<b>TT QUATTRO</b>									
00-06	180 HP	F	R.33062	R.33062	R.33062.1S	R.33062.2S	R.33062.1C	R.33062.2C	
		R	R.33068	R.33068	R.33068.1S	R.33068.2S	R.33068.1C	R.33068.2C	
00-06	225 HP	F	R.33062	R.33062	R.33062.1S	R.33062.2S	R.33062.1C	R.33062.2C	
		R	R.33069	R.33069	R.33069.1S	R.33069.2S	R.33069.1C	R.33069.2C	
04-06	3.2L(V6)	F	R.33094	R.33093	R.33094.1S	R.33094.2S	R.33094.1C	R.33094.2C	A, B
		R	R.33069	R.33069	R.33069.1S	R.33069.2S	R.33069.1C	R.33069.2C	
<b>BMW</b>									
<b>M3</b>									

BRAKE DISC		BASIC OEM		SLOTTED		DRILLED & SLOTTED		NOTES	
MAKE/MODEL		AXLE	PART #		PART #		PART #		NOTES
YEAR		F/R	LEFT	RIGHT	LEFT	RIGHT	LEFT	RIGHT	
87-91	E30	F	R.34023	R.34023	R.34023.1S	R.34023.2S	R.34023.1C	R.34023.2C	
		R	R.34028	R.34028	R.34028.1S	R.34028.2S	R.34028.1C	R.34028.2C	
95-99	E36	F	R.34038	R.34039	R.34038.1S	R.34038.2S	R.34038.1C	R.34038.2C	B
		R	R.34036	R.34037	R.34036.1S	R.34036.2S	R.34036.1C	R.34036.2C	B
01-07	E46 (EXC COMPETITION PKG)	F	R.34058	R.34059	R.34058.1S	R.34058.2S	R.34058.1C	R.34058.2C	B
		R	R.34054	R.34054	R.34054.1S	R.34054.2S	R.34054.1C	R.34054.2C	
<b>M5</b>									
89-93		F	R.34033	R.34033	R.34033.1S	R.34033.2S	R.34033.1C	R.34033.2C	
		R	R.34034	R.34034	R.34034.1S	R.34034.2S	R.34034.1C	R.34034.2C	
00-04	E39	F	R.34062	R.34063	R.34062.1S	R.34062.2S	R.34062.1C	R.34062.2C	B, C
		R	R.34054	R.34054	R.34054.1S	R.34054.2S	R.34054.1C	R.34054.2C	
<b>X3</b>									
04-07		F	R.34075	R.34075	R.34075.1S	R.34075.2S	R.34075.1C	R.34075.2C	
		R	R.34076	R.34076	R.34076.1S	R.34076.2S	R.34076.1C	R.34076.2C	
<b>X5</b>									
00-01		F	R.34050	R.34050	R.34050.1S	R.34050.2S	R.34050.1C	R.34050.2C	A
		R	R.34051	R.34051	R.34051.1S	R.34051.2S	R.34051.1C	R.34051.2C	A
02-03	3.0i, 4.4i (W/ SOLID REAR DISC)	F	R.34050	R.34050	R.34050.1S	R.34050.2S	R.34050.1C	R.34050.2C	A
		R	R.34051	R.34051	R.34051.1S	R.34051.2S	R.34051.1C	R.34051.2C	A
02-03	4.6is	F	R.34060	R.34060	R.34060.1S	R.34060.2S	R.34060.1C	R.34060.2C	A
		R	R.34061	R.34061	R.34061.1S	R.34061.2S	R.34061.1C	R.34061.2C	A
04	3.0i, 4.4i (W/ SOLID REAR DISC)	F	R.34050	R.34050	R.34050.1S	R.34050.2S	R.34050.1C	R.34050.2C	A
		R	R.34051	R.34051	R.34051.1S	R.34051.2S	R.34051.1C	R.34051.2C	A
04	4.4i (W/ VENTED REAR DISC)	F	R.34050	R.34050	R.34050.1S	R.34050.2S	R.34050.1C	R.34050.2C	A
		R	R.34061	R.34061	R.34061.1S	R.34061.2S	R.34061.1C	R.34061.2C	A
05-06	3.0i (W/ SOLID REAR DISC)	F	R.34050	R.34050	R.34050.1S	R.34050.2S	R.34050.1C	R.34050.2C	A
		R	R.34051	R.34051	R.34051.1S	R.34051.2S	R.34051.1C	R.34051.2C	A
05-06	4.4i (W/ VENTED REAR DISC)	F	R.34050	R.34050	R.34050.1S	R.34050.2S	R.34050.1C	R.34050.2C	A
		R	R.34061	R.34061	R.34061.1S	R.34061.2S	R.34061.1C	R.34061.2C	A
05-06	4.8is	F	R.34060	R.34060	R.34060.1S	R.34060.2S	R.34060.1C	R.34060.2C	A
		R	R.34061	R.34061	R.34061.1S	R.34061.2S	R.34061.1C	R.34061.2C	A
<b>Z3</b>									
96-97	4 CYL.	F	R.34040	R.34040	R.34040.1S	R.34040.2S	R.34040.1C	R.34040.2C	
		R	R.34047	R.34047	R.34047.1S	R.34047.2S	R.34047.1C	R.34047.2C	
96-97	EXC M SERIES (6 CYL.)	F	R.34029	R.34029	R.34029.1S	R.34029.2S	R.34029.1C	R.34029.2C	
		R	R.34047	R.34047	R.34047.1S	R.34047.2S	R.34047.1C	R.34047.2C	
98	4 CYL.	F	R.34040	R.34040	R.34040.1S	R.34040.2S	R.34040.1C	R.34040.2C	
		R	R.34047	R.34047	R.34047.1S	R.34047.2S	R.34047.1C	R.34047.2C	
98	EXC M SERIES (6 CYL.)	F	R.34029	R.34029	R.34029.1S	R.34029.2S	R.34029.1C	R.34029.2C	
		R	R.34047	R.34047	R.34047.1S	R.34047.2S	R.34047.1C	R.34047.2C	
98	M SERIES	F	R.34038	R.34039	R.34038.1S	R.34038.2S	R.34038.1C	R.34038.2C	B
		R	R.34036	R.34037	R.34036.1S	R.34036.2S	R.34036.1C	R.34036.2C	B
99-00	EXC M SERIES	F	R.34029	R.34029	R.34029.1S	R.34029.2S	R.34029.1C	R.34029.2C	
		R	R.34047	R.34047	R.34047.1S	R.34047.2S	R.34047.1C	R.34047.2C	
99-00	M SERIES	F	R.34038	R.34039	R.34038.1S	R.34038.2S	R.34038.1C	R.34038.2C	B
		R	R.34036	R.34037	R.34036.1S	R.34036.2S	R.34036.1C	R.34036.2C	B
01-02	2.5L	F	R.34029	R.34029	R.34029.1S	R.34029.2S	R.34029.1C	R.34029.2C	
		R	R.34047	R.34047	R.34047.1S	R.34047.2S	R.34047.1C	R.34047.2C	
01-02	3.0L (EXC M SERIES)	F	R.34048	R.34048	R.34048.1S	R.34048.2S	R.34048.1C	R.34048.2C	
		R	R.34047	R.34047	R.34047.1S	R.34047.2S	R.34047.1C	R.34047.2C	
01-02	M SERIES	F	R.34038	R.34039	R.34038.1S	R.34038.2S	R.34038.1C	R.34038.2C	B
		R	R.34036	R.34037	R.34036.1S	R.34036.2S	R.34036.1C	R.34036.2C	B
<b>Z4</b>									
03-1/06	2.5i	F	R.34029	R.34029	R.34029.1S	R.34029.2S	R.34029.1C	R.34029.2C	
		R	R.34068	R.34068	R.34068.1S	R.34068.2S	R.34068.1C	R.34068.2C	C
03-1/06	3.0i	F	R.34048	R.34048	R.34048.1S	R.34048.2S	R.34048.1C	R.34048.2C	
		R	R.34069	R.34069	R.34069.1S	R.34069.2S	R.34069.1C	R.34069.2C	C
2/06-07	3.0i	F	R.34048	R.34048	R.34048.1S	R.34048.2S	R.34048.1C	R.34048.2C	
		R	R.34069	R.34069	R.34069.1S	R.34069.2S	R.34069.1C	R.34069.2C	C
2/06-07	3.0Si	F	R.34052	R.34052	R.34052.1S	R.34052.2S	R.34052.1C	R.34052.2C	
		R	R.34069	R.34069	R.34069.1S	R.34069.2S	R.34069.1C	R.34069.2C	C
<b>Z8 (ALPINA ROADSTER)</b>									
00-03		F							
		R	R.34043	R.34043	R.34043.1S	R.34043.2S	R.34043.1C	R.34043.2C	
<b>318i, iS</b>									
90-4/91	E30	F	R.34018	R.34018	R.34018.1S	R.34018.2S	R.34018.1C	R.34018.2C	
		R	R.34019	R.34019	R.34019.1S	R.34019.2S	R.34019.1C	R.34019.2C	
11/91-98	E36	F	R.34029	R.34029	R.34029.1S	R.34029.2S	R.34029.1C	R.34029.2C	

BRAKE DISC		BASIC OEM		SLOTTED		DRILLED & SLOTTED		NOTES
MAKE/MODEL	AXLE	PART #		PART #		PART #		
YEAR	F/R	LEFT	RIGHT	LEFT	RIGHT	LEFT	RIGHT	
	R	R.34030	R.34030	R.34030.1S	R.34030.2S	R.34030.1C	R.34030.2C	
<b>318Ti</b>								
95-99	F	R.34040	R.34040	R.34040.1S	R.34040.2S	R.34040.1C	R.34040.2C	
	R	R.34041	R.34041	R.34041.1S	R.34041.2S	R.34041.1C	R.34041.2C	
<b>323 SERIES (E36, E46)</b>								
98-99	F	R.34029	R.34029	R.34029.1S	R.34029.2S	R.34029.1C	R.34029.2C	
	R	R.34044	R.34044	R.34044.1S	R.34044.2S	R.34044.1C	R.34044.2C	
98-99	F	R.34029	R.34029	R.34029.1S	R.34029.2S	R.34029.1C	R.34029.2C	
	R	R.34030	R.34030	R.34030.1S	R.34030.2S	R.34030.1C	R.34030.2C	
00	F	R.34029	R.34029	R.34029.1S	R.34029.2S	R.34029.1C	R.34029.2C	
	R	R.34044	R.34044	R.34044.1S	R.34044.2S	R.34044.1C	R.34044.2C	
00	F	R.34048	R.34048	R.34048.1S	R.34048.2S	R.34048.1C	R.34048.2C	
	R	R.34049	R.34049	R.34049.1S	R.34049.2S	R.34049.1C	R.34049.2C	
<b>325, 328 SERIES (E30, E36)</b>								
89-9/90	F	R.34018	R.34018	R.34018.1S	R.34018.2S	R.34018.1C	R.34018.2C	
	R	R.61066	R.61066	R.61066.1S	R.61066.2S	R.61066.1C	R.61066.2C	
89-9/90	F	R.34018	R.34018	R.34018.1S	R.34018.2S	R.34018.1C	R.34018.2C	
	R	R.34019	R.34019	R.34019.1S	R.34019.2S	R.34019.1C	R.34019.2C	
10/90-4/91	F	R.34018	R.34018	R.34018.1S	R.34018.2S	R.34018.1C	R.34018.2C	
	R	R.34019	R.34019	R.34019.1S	R.34019.2S	R.34019.1C	R.34019.2C	
10/90-4/91	F	R.34029	R.34029	R.34029.1S	R.34029.2S	R.34029.1C	R.34029.2C	
	R	R.34030	R.34030	R.34030.1S	R.34030.2S	R.34030.1C	R.34030.2C	
5/91-96	F	R.34029	R.34029	R.34029.1S	R.34029.2S	R.34029.1C	R.34029.2C	
	R	R.34030	R.34030	R.34030.1S	R.34030.2S	R.34030.1C	R.34030.2C	
97-99	F	R.34029	R.34029	R.34029.1S	R.34029.2S	R.34029.1C	R.34029.2C	
	R	R.34030	R.34030	R.34030.1S	R.34030.2S	R.34030.1C	R.34030.2C	
97-99	F	R.34029	R.34029	R.34029.1S	R.34029.2S	R.34029.1C	R.34029.2C	
	R	R.34044	R.34044	R.34044.1S	R.34044.2S	R.34044.1C	R.34044.2C	
<b>325 SERIES (E46, E90)</b>								
01-05	F	R.34048	R.34048	R.34048.1S	R.34048.2S	R.34048.1C	R.34048.2C	
	R	R.34056	R.34056	R.34056.1S	R.34056.2S	R.34056.1C	R.34056.2C	A
01-05	F	R.34048	R.34048	R.34048.1S	R.34048.2S	R.34048.1C	R.34048.2C	
	R	R.34049	R.34049	R.34049.1S	R.34049.2S	R.34049.1C	R.34049.2C	
06	F	R.34048	R.34048	R.34048.1S	R.34048.2S	R.34048.1C	R.34048.2C	
	R	R.34049	R.34049	R.34049.1S	R.34049.2S	R.34049.1C	R.34049.2C	
06	F	R.34077	R.34077	R.34077.1S	R.34077.2S	R.34077.1C	R.34077.2C	C
	R	R.34078	R.34078	R.34078.1S	R.34078.2S	R.34078.1C	R.34078.2C	C
06	F	R.34077	R.34077	R.34077.1S	R.34077.2S	R.34077.1C	R.34077.2C	C
	R	R.34091	R.34091	R.34091.1S	R.34091.2S	R.34091.1C	R.34091.2C	C
07	F	R.34048	R.34048	R.34048.1S	R.34048.2S	R.34048.1C	R.34048.2C	
	R	R.34049	R.34049	R.34049.1S	R.34049.2S	R.34049.1C	R.34049.2C	
<b>328 SERIES (E46, E90, E91, E92)</b>								
99-00	F	R.34048	R.34048	R.34048.1S	R.34048.2S	R.34048.1C	R.34048.2C	
	R	R.34049	R.34049	R.34049.1S	R.34049.2S	R.34049.1C	R.34049.2C	
07	F	R.34077	R.34077	R.34077.1S	R.34077.2S	R.34077.1C	R.34077.2C	C
	R	R.34078	R.34078	R.34078.1S	R.34078.2S	R.34078.1C	R.34078.2C	C
07	F	R.34077	R.34077	R.34077.1S	R.34077.2S	R.34077.1C	R.34077.2C	C
	R	R.34091	R.34091	R.34091.1S	R.34091.2S	R.34091.1C	R.34091.2C	C
<b>330 SERIES (E46, E90)</b>								
00-06	F	R.34052	R.34052	R.34052.1S	R.34052.2S	R.34052.1C	R.34052.2C	
	R	R.34057	R.34057	R.34057.1S	R.34057.2S	R.34057.1C	R.34057.2C	
06	F	R.34079	R.34079	R.34079.1S	R.34079.2S	R.34079.1C	R.34079.2C	C
	R	R.34080	R.34080	R.34080.1S	R.34080.2S	R.34080.1C	R.34080.2C	C
07	F	R.34052	R.34052	R.34052.1S	R.34052.2S	R.34052.1C	R.34052.2C	
	R	R.34057	R.34057	R.34057.1S	R.34057.2S	R.34057.1C	R.34057.2C	
<b>335i SERIES (E90, E92)</b>								
07	F	R.34093	R.34093	R.34093.1S	R.34093.2S	R.34093.1C	R.34093.2C	C
	R	R.34080	R.34080	R.34080.1S	R.34080.2S	R.34080.1C	R.34080.2C	C
<b>525i</b>								
89-95	F	R.34024	R.34024	R.34024.1S	R.34024.2S	R.34024.1C	R.34024.2C	
	R	R.34025	R.34025	R.34025.1S	R.34025.2S	R.34025.1C	R.34025.2C	
01-03	F	R.34045	R.34045	R.34045.1S	R.34045.2S	R.34045.1C	R.34045.2C	
	R	R.34046	R.34046	R.34046.1S	R.34046.2S	R.34046.1C	R.34046.2C	
04-05	F	R.34073	R.34073	R.34073.1S	R.34073.2S	R.34073.1C	R.34073.2C	
	R	R.34074	R.34074	R.34074.1S	R.34074.2S	R.34074.1C	R.34074.2C	
04-05	F	R.34070	R.34070	R.34070.1S	R.34070.2S	R.34070.1C	R.34070.2C	
	R	R.34074	R.34074	R.34074.1S	R.34074.2S	R.34074.1C	R.34074.2C	
06-07	F	R.34070	R.34070	R.34070.1S	R.34070.2S	R.34070.1C	R.34070.2C	

MAKE/MODEL		AXLE	BASIC OEM		SLOTTED		DRILLED & SLOTTED		NOTES
			PART #		PART #		PART #		
YEAR		F/R	LEFT	RIGHT	LEFT	RIGHT	LEFT	RIGHT	
06-07	XI-AWD	R	R.34074	R.34074	R.34074.1S	R.34074.2S	R.34074.1C	R.34074.2C	
		F	R.34070	R.34070	R.34070.1S	R.34070.2S	R.34070.1C	R.34070.2C	
		R	R.34085	R.34085	R.34085.1S	R.34085.2S	R.34085.1C	R.34085.2C	
<b>528i</b>									
96-00		F	R.34045	R.34045	R.34045.1S	R.34045.2S	R.34045.1C	R.34045.2C	
	R	R.34046	R.34046	R.34046.1S	R.34046.2S	R.34046.1C	R.34046.2C		
<b>530i</b>									
93-95		F	R.34024	R.34024	R.34024.1S	R.34024.2S	R.34024.1C	R.34024.2C	
	R	R.34025	R.34025	R.34025.1S	R.34025.2S	R.34025.1C	R.34025.2C		
01-03		F	R.34055	R.34055	R.34055.1S	R.34055.2S	R.34055.1C	R.34055.2C	
		R	R.34046	R.34046	R.34046.1S	R.34046.2S	R.34046.1C	R.34046.2C	
04-07	EXC XI-AWD	F	R.34070	R.34070	R.34070.1S	R.34070.2S	R.34070.1C	R.34070.2C	
		R	R.34074	R.34074	R.34074.1S	R.34074.2S	R.34074.1C	R.34074.2C	
06-07	XI-AWD	F	R.34070	R.34070	R.34070.1S	R.34070.2S	R.34070.1C	R.34070.2C	
		R	R.34085	R.34085	R.34085.1S	R.34085.2S	R.34085.1C	R.34085.2C	
<b>535i, is</b>									
89-93		F	R.34024	R.34024	R.34024.1S	R.34024.2S	R.34024.1C	R.34024.2C	
	R	R.34025	R.34025	R.34025.1S	R.34025.2S	R.34025.1C	R.34025.2C		
<b>540i</b>									
93-95		F	R.34021	R.34021	R.34021.1S	R.34021.2S	R.34021.1C	R.34021.2C	
	R	R.34034	R.34034	R.34034.1S	R.34034.2S	R.34034.1C	R.34034.2C		
96-3/00		F	R.34031	R.34031	R.34031.1S	R.34031.2S	R.34031.1C	R.34031.2C	
	R	R.34046	R.34046	R.34046.1S	R.34046.2S	R.34046.1C	R.34046.2C		
4/00-03		F	R.34055	R.34055	R.34055.1S	R.34055.2S	R.34055.1C	R.34055.2C	
	R	R.34046	R.34046	R.34046.1S	R.34046.2S	R.34046.1C	R.34046.2C		
<b>545i, 550i (E60)</b>									
04-07		F	R.34071	R.34071	R.34071.1S	R.34071.2S	R.34071.1C	R.34071.2C	C
	R	R.34072	R.34072	R.34072.1S	R.34072.2S	R.34072.1C	R.34072.2C	C	
<b>645Ci, 650i (E63, E64)</b>									
04-06		F	R.34071	R.34071	R.34071.1S	R.34071.2S	R.34071.1C	R.34071.2C	C
	R	R.34072	R.34072	R.34072.1S	R.34072.2S	R.34072.1C	R.34072.2C	C	
<b>730i</b>									
92-93		F	R.34024	R.34024	R.34024.1S	R.34024.2S	R.34024.1C	R.34024.2C	
	R	R.34022	R.34022	R.34022.1S	R.34022.2S	R.34022.1C	R.34022.2C		
<b>735, 735i, 735iL</b>									
3/88-92		F	R.34021	R.34021	R.34021.1S	R.34021.2S	R.34021.1C	R.34021.2C	
	R	R.34022	R.34022	R.34022.1S	R.34022.2S	R.34022.1C	R.34022.2C		
<b>740i, 740iL</b>									
93-94		F	R.34021	R.34021	R.34021.1S	R.34021.2S	R.34021.1C	R.34021.2C	
	R	R.34026	R.34026	R.34026.1S	R.34026.2S	R.34026.1C	R.34026.2C		
95-01		F	R.34031	R.34031	R.34031.1S	R.34031.2S	R.34031.1C	R.34031.2C	
	R	R.34032	R.34032	R.34032.1S	R.34032.2S	R.34032.1C	R.34032.2C		
<b>745i (E65), 745Li (E66)</b>									
02-05		F	R.34064	R.34064	R.34064.1S	R.34064.2S	R.34064.1C	R.34064.2C	A
	R	R.34065	R.34065	R.34065.1S	R.34065.2S	R.34065.1C	R.34065.2C		
<b>750i, 750iL (E32, E38), 750i, 750Li (E65, E66)</b>									
88-94		F	R.34021	R.34021	R.34021.1S	R.34021.2S	R.34021.1C	R.34021.2C	
	R	R.34026	R.34026	R.34026.1S	R.34026.2S	R.34026.1C	R.34026.2C		
95-01		F	R.34042	R.34042	R.34042.1S	R.34042.2S	R.34042.1C	R.34042.2C	
	R	R.34043	R.34043	R.34043.1S	R.34043.2S	R.34043.1C	R.34043.2C		
06-07		F	R.34064	R.34064	R.34064.1S	R.34064.2S	R.34064.1C	R.34064.2C	A
	R								
<b>760i (E65), 760Li (E66)</b>									
03-3/05		F	R.34064	R.34064	R.34064.1S	R.34064.2S	R.34064.1C	R.34064.2C	A
	R	R.34065	R.34065	R.34065.1S	R.34065.2S	R.34065.1C	R.34065.2C		
6/05-06		F	R.34064	R.34064	R.34064.1S	R.34064.2S	R.34064.1C	R.34064.2C	A
	R								
<b>840Ci</b>									
94-97		F	R.34035	R.34035	R.34035.1S	R.34035.2S	R.34035.1C	R.34035.2C	
	R	R.34032	R.34032	R.34032.1S	R.34032.2S	R.34032.1C	R.34032.2C		
<b>850Ci, 850i</b>									
90-7/93		F	R.34031	R.34031	R.34031.1S	R.34031.2S	R.34031.1C	R.34031.2C	
	R	R.34032	R.34032	R.34032.1S	R.34032.2S	R.34032.1C	R.34032.2C		
8/93-97		F	R.34035	R.34035	R.34035.1S	R.34035.2S	R.34035.1C	R.34035.2C	
	R	R.34032	R.34032	R.34032.1S	R.34032.2S	R.34032.1C	R.34032.2C		
<b>850CSI</b>									
94-95		F	R.34031	R.34031	R.34031.1S	R.34031.2S	R.34031.1C	R.34031.2C	
	R	R.34032	R.34032	R.34032.1S	R.34032.2S	R.34032.1C	R.34032.2C		



BRAKE DISC		BASIC OEM		SLOTTED		DRILLED & SLOTTED		NOTES
MAKE/MODEL	AXLE	PART #		PART #		PART #		
YEAR	F/R	LEFT	RIGHT	LEFT	RIGHT	LEFT	RIGHT	
<b>BUICK</b>								
<b>ALLURE (CANADA)</b>								
05-07	F	R.62073	R.62073	R.62073.1S	R.62073.2S	R.62073.1C	R.62073.2C	
	R	R.62074	R.62074	R.62074.1S	R.62074.2S	R.62074.1C	R.62074.2C	
<b>CENTURY</b>								
90-96	F	R.62017	R.62017	R.62017.1S	R.62017.2S	R.62017.1C	R.62017.2C	
	R							
97-03	F	R.62057	R.62057	R.62057.1S	R.62057.2S	R.62057.1C	R.62057.2C	
	R	R.62058	R.62058	R.62058.1S	R.62058.2S	R.62058.1C	R.62058.2C	
04-05	F	R.62057	R.62057	R.62057.1S	R.62057.2S	R.62057.1C	R.62057.2C	
	R	R.62058	R.62058	R.62058.1S	R.62058.2S	R.62058.1C	R.62058.2C	
<b>LA CROSSE</b>								
05-07	F	R.62073	R.62073	R.62073.1S	R.62073.2S	R.62073.1C	R.62073.2C	
	R	R.62074	R.62074	R.62074.1S	R.62074.2S	R.62074.1C	R.62074.2C	
<b>LE SABRE</b>								
90-91	F	R.62017	R.62017	R.62017.1S	R.62017.2S	R.62017.1C	R.62017.2C	
	R							
92-97	F	R.62050	R.62050	R.62050.1S	R.62050.2S	R.62050.1C	R.62050.2C	
	R							
98-99	F	R.62057	R.62057	R.62057.1S	R.62057.2S	R.62057.1C	R.62057.2C	
	R							
00-04	15" WHEEL	F	R.62057	R.62057	R.62057.1S	R.62057.2S	R.62057.1C	R.62057.2C
		R	R.62045	R.62045	R.62045.1S	R.62045.2S	R.62045.1C	R.62045.2C
00-04	16" WHEEL	F	R.62055	R.62055	R.62055.1S	R.62055.2S	R.62055.1C	R.62055.2C
		R	R.62045	R.62045	R.62045.1S	R.62045.2S	R.62045.1C	R.62045.2C
05	15" WHEEL	F	R.62057	R.62057	R.62057.1S	R.62057.2S	R.62057.1C	R.62057.2C
		R	R.62045	R.62045	R.62045.1S	R.62045.2S	R.62045.1C	R.62045.2C
05	16" WHEEL	F	R.62087	R.62087	R.62087.1S	R.62087.2S	R.62087.1C	R.62087.2C
		R	R.62045	R.62045	R.62045.1S	R.62045.2S	R.62045.1C	R.62045.2C
<b>LUCERNE</b>								
06-07	CX, CXL (3.8L V6)	F	R.62098	R.62098	R.62098.1S	R.62098.2S	R.62098.1C	R.62098.2C
		R	R.62101	R.62101	R.62101.1S	R.62101.2S	R.62101.1C	R.62101.2C
06-07	CXL, CXS (4.6L V8)	F	R.62099	R.62099	R.62099.1S	R.62099.2S	R.62099.1C	R.62099.2C
		R	R.62101	R.62101	R.62101.1S	R.62101.2S	R.62101.1C	R.62101.2C
<b>PARK AVENUE</b>								
91-96		F	R.62050	R.62050	R.62050.1S	R.62050.2S	R.62050.1C	R.62050.2C
		R						
97	W/ REAR DRUM	F	R.62055	R.62055	R.62055.1S	R.62055.2S	R.62055.1C	R.62055.2C
		R						
97	W/ REAR DISC	F	R.62055	R.62055	R.62055.1S	R.62055.2S	R.62055.1C	R.62055.2C
		R	R.62045	R.62045	R.62045.1S	R.62045.2S	R.62045.1C	R.62045.2C
98-02	W/ REAR DISC (EXC ULTRA SERIES)	F	R.62055	R.62055	R.62055.1S	R.62055.2S	R.62055.1C	R.62055.2C
		R	R.62045	R.62045	R.62045.1S	R.62045.2S	R.62045.1C	R.62045.2C
03-05	EXC ULTRA SERIES	F	R.62055	R.62055	R.62055.1S	R.62055.2S	R.62055.1C	R.62055.2C
		R	R.62045	R.62045	R.62045.1S	R.62045.2S	R.62045.1C	R.62045.2C
03-05	ULTRA SERIES	F	R.62055	R.62055	R.62055.1S	R.62055.2S	R.62055.1C	R.62055.2C
		R	R.62064	R.62064	R.62064.1S	R.62064.2S	R.62064.1C	R.62064.2C
<b>RAINER</b>								
04-05	5 PASSENGER	F	R.66051	R.66051	R.66051.1S	R.66051.2S	R.66051.1C	R.66051.2C
		R	R.66052	R.66052	R.66052.1S	R.66052.2S	R.66052.1C	R.66052.2C
06-07	4.2L (6 CYL.)	F	R.66063	R.66063	R.66063.1S	R.66063.2S	R.66063.1C	R.66063.2C
		R	R.66052	R.66052	R.66052.1S	R.66052.2S	R.66052.1C	R.66052.2C
06-07	5.3L (V8)	F	R.66053	R.66053	R.66053.1S	R.66053.2S	R.66053.1C	R.66053.2C
		R	R.66052	R.66052	R.66052.1S	R.66052.2S	R.66052.1C	R.66052.2C
<b>REATTA</b>								
90-91		F	R.62017	R.62017	R.62017.1S	R.62017.2S	R.62017.1C	R.62017.2C
		R	R.62024	R.62024	R.62024.1S	R.62024.2S	R.62024.1C	R.62024.2C
<b>REGAL</b>								
89-93		F	R.62028	R.62028	R.62028.1S	R.62028.2S	R.62028.1C	R.62028.2C
		R	R.62029	R.62029	R.62029.1S	R.62029.2S	R.62029.1C	R.62029.2C
94-95	W/ 267MM DISC	F	R.62028	R.62028	R.62028.1S	R.62028.2S	R.62028.1C	R.62028.2C
		R	R.62051	R.62051	R.62051.1S	R.62051.2S	R.62051.1C	R.62051.2C
95-96	W/ 286MM DISC	F	R.62054	R.62054	R.62054.1S	R.62054.2S	R.62054.1C	R.62054.2C
		R	R.62051	R.62051	R.62051.1S	R.62051.2S	R.62051.1C	R.62051.2C
97-98		F	R.62057	R.62057	R.62057.1S	R.62057.2S	R.62057.1C	R.62057.2C
		R	R.62058	R.62058	R.62058.1S	R.62058.2S	R.62058.1C	R.62058.2C
99-02	GS	F	R.62057	R.62057	R.62057.1S	R.62057.2S	R.62057.1C	R.62057.2C

MAKE/MODEL YEAR		AXLE F/R	BASIC OEM		SLOTTED		DRILLED & SLOTTED		NOTES
			PART #		PART #		PART #		
			LEFT	RIGHT	LEFT	RIGHT	LEFT	RIGHT	
99-02	LS	R	R.62058	R.62058	R.62058.1S	R.62058.2S	R.62058.1C	R.62058.2C	
		F	R.62057	R.62057	R.62057.1S	R.62057.2S	R.62057.1C	R.62057.2C	
03-04		F	R.62057	R.62057	R.62057.1S	R.62057.2S	R.62057.1C	R.62057.2C	
		R	R.62058	R.62058	R.62058.1S	R.62058.2S	R.62058.1C	R.62058.2C	
<b>RENDEZVOUS</b>									
02-07	2WD	F	R.66046	R.66046	R.66046.1S	R.66046.2S	R.66046.1C	R.66046.2C	
		R	R.66048	R.66048	R.66048.1S	R.66048.2S	R.66048.1C	R.66048.2C	
02-07	4WD	F	R.66047	R.66047	R.66047.1S	R.66047.2S	R.66047.1C	R.66047.2C	
		R	R.66048	R.66048	R.66048.1S	R.66048.2S	R.66048.1C	R.66048.2C	
<b>RIVIERA</b>									
90-91		F	R.62017	R.62017	R.62017.1S	R.62017.2S	R.62017.1C	R.62017.2C	
		R	R.62024	R.62024	R.62024.1S	R.62024.2S	R.62024.1C	R.62024.2C	
92-96		F	R.62050	R.62050	R.62050.1S	R.62050.2S	R.62050.1C	R.62050.2C	
		R	R.62045	R.62045	R.62045.1S	R.62045.2S	R.62045.1C	R.62045.2C	
97-99		F	R.62055	R.62055	R.62055.1S	R.62055.2S	R.62055.1C	R.62055.2C	
		R	R.62045	R.62045	R.62045.1S	R.62045.2S	R.62045.1C	R.62045.2C	
<b>ROADMASTER</b>									
91-96		F	R.62035	R.62035	R.62035.1S	R.62035.2S	R.62035.1C	R.62035.2C	
		R							
<b>SKYLARK</b>									
90	EXC PERFORMANCE PKG	F	R.62023	R.62023	R.62023.1S	R.62023.2S	R.62023.1C	R.62023.2C	
		R							
90	W/ PERFORMANCE PKG	F	R.62034	R.62034	R.62034.1S	R.62034.2S	R.62034.1C	R.62034.2C	
		R							
91-98		F	R.62034	R.62034	R.62034.1S	R.62034.2S	R.62034.1C	R.62034.2C	
		R							
<b>TERRAZA</b>									
05	FWD (EXC SPECIAL SUSPENSION)	F	R.62073	R.62073	R.62073.1S	R.62073.2S	R.62073.1C	R.62073.2C	
		R	R.66060	R.66060	R.66060.1S	R.66060.2S	R.66060.1C	R.66060.2C	
05	FWD (W/ SPECIAL SUSPENSION) AWD	F	R.62073	R.62073	R.62073.1S	R.62073.2S	R.62073.1C	R.62073.2C	
		R	R.66058	R.66058	R.66058.1S	R.66058.2S	R.66058.1C	R.66058.2C	
06	FWD (EXC SPECIAL SUSPENSION)	F	R.66061	R.66061	R.66061.1S	R.66061.2S	R.66061.1C	R.66061.2C	
		R	R.66062	R.66062	R.66062.1S	R.66062.2S	R.66062.1C	R.66062.2C	
06	FWD (W/ SPECIAL SUSPENSION) AWD	F	R.66061	R.66061	R.66061.1S	R.66061.2S	R.66061.1C	R.66061.2C	
		R	R.66066	R.66066	R.66066.1S	R.66066.2S	R.66066.1C	R.66066.2C	
07	FWD	F	R.66061	R.66061	R.66061.1S	R.66061.2S	R.66061.1C	R.66061.2C	
		R	R.66062	R.66062	R.66062.1S	R.66062.2S	R.66062.1C	R.66062.2C	
<b>CADILLAC</b>									
<b>ALLANTÉ</b>									
90-92		F	R.62017	R.62017	R.62017.1S	R.62017.2S	R.62017.1C	R.62017.2C	
		R	R.62024	R.62024	R.62024.1S	R.62024.2S	R.62024.1C	R.62024.2C	
93		F	R.62050	R.62050	R.62050.1S	R.62050.2S	R.62050.1C	R.62050.2C	
		R	R.62045	R.62045	R.62045.1S	R.62045.2S	R.62045.1C	R.62045.2C	
<b>CTS (EXC CTS-V)</b>									
03-05	STD SUSPENSION	F	R.62069	R.62069	R.62069.1S	R.62069.2S	R.62069.1C	R.62069.2C	
		R	R.62071	R.62071	R.62071.1S	R.62071.2S	R.62071.1C	R.62071.2C	
03-05	SPORT SUSPENSION	F	R.62070	R.62070	R.62070.1S	R.62070.2S	R.62070.1C	R.62070.2C	
		R	R.62071	R.62071	R.62071.1S	R.62071.2S	R.62071.1C	R.62071.2C	
06-07	STD SUSPENSION	F	R.62069	R.62069	R.62069.1S	R.62069.2S	R.62069.1C	R.62069.2C	
		R	R.62071	R.62071	R.62071.1S	R.62071.2S	R.62071.1C	R.62071.2C	
06-07	SPORT SUSPENSION	F	R.62084	R.62084	R.62084.1S	R.62084.2S	R.62084.1C	R.62084.2C	
		R	R.62088	R.62088	R.62088.1S	R.62088.2S	R.62088.1C	R.62088.2C	
<b>CTS-V</b>									
04-07	W/ BREMBO CALIPER	F	R.62075	R.62075	R.62075.1S	R.62075.2S	R.62075.1C	R.62075.2C	
		R	R.62076	R.62076	R.62076.1S	R.62076.2S	R.62076.1C	R.62076.2C	
<b>DEVILLE, DEVILLE CONCOURS</b>									
90	STD	F	R.62017	R.62017	R.62017.1S	R.62017.2S	R.62017.1C	R.62017.2C	
		R							
90	HD	F	R.62050	R.62050	R.62050.1S	R.62050.2S	R.62050.1C	R.62050.2C	
		R							
91-93	STD, HD	F	R.62050	R.62050	R.62050.1S	R.62050.2S	R.62050.1C	R.62050.2C	
		R							
94-96		F	R.62050	R.62050	R.62050.1S	R.62050.2S	R.62050.1C	R.62050.2C	
		R	R.62045	R.62045	R.62045.1S	R.62045.2S	R.62045.1C	R.62045.2C	
97		F	R.62055	R.62055	R.62055.1S	R.62055.2S	R.62055.1C	R.62055.2C	
		R	R.62045	R.62045	R.62045.1S	R.62045.2S	R.62045.1C	R.62045.2C	

BRAKE DISC		BASIC OEM		SLOTTED		DRILLED & SLOTTED		NOTES	
		AXLE	PART #		PART #		PART #		
MAKE/MODEL	YEAR	F/R	LEFT	RIGHT	LEFT	RIGHT	LEFT	RIGHT	
98-99	STD, W/ REAR DISC	F	R.62055	R.62055	R.62055.1S	R.62055.2S	R.62055.1C	R.62055.2C	
		R	R.62045	R.62045	R.62045.1S	R.62045.2S	R.62045.1C	R.62045.2C	
98-99	HD, W/ REAR DRUM	F	R.62063	R.62063	R.62063.1S	R.62063.2S	R.62063.1C	R.62063.2C	
		R							
00-05	STD	F	R.62055	R.62055	R.62055.1S	R.62055.2S	R.62055.1C	R.62055.2C	
		R	R.62064	R.62064	R.62064.1S	R.62064.2S	R.62064.1C	R.62064.2C	
00-05	HD	F	R.66042	R.66042	R.66042.1S	R.66042.2S	R.66042.1C	R.66042.2C	
		R	R.62067	R.62067	R.62067.1S	R.62067.2S	R.62067.1C	R.62067.2C	
<b>DTS</b>									
06-07	SEDAN	F	R.62099	R.62099	R.62099.1S	R.62099.2S	R.62099.1C	R.62099.2C	
		R	R.62101	R.62101	R.62101.1S	R.62101.2S	R.62101.1C	R.62101.2C	
06-07	HD	F	R.62100	R.62100	R.62100.1S	R.62100.2S	R.62100.1C	R.62100.2C	
		R	R.62067	R.62067	R.62067.1S	R.62067.2S	R.62067.1C	R.62067.2C	
<b>ELDORADO</b>									
90-91		F	R.62017	R.62017	R.62017.1S	R.62017.2S	R.62017.1C	R.62017.2C	
		R	R.62024	R.62024	R.62024.1S	R.62024.2S	R.62024.1C	R.62024.2C	
92-96		F	R.62050	R.62050	R.62050.1S	R.62050.2S	R.62050.1C	R.62050.2C	
		R	R.62045	R.62045	R.62045.1S	R.62045.2S	R.62045.1C	R.62045.2C	
97-02		F	R.62055	R.62055	R.62055.1S	R.62055.2S	R.62055.1C	R.62055.2C	
		R	R.62045	R.62045	R.62045.1S	R.62045.2S	R.62045.1C	R.62045.2C	
<b>ESCALADE</b>									
99-01		F	R.66009	R.66009	R.66009.1S	R.66009.2S	R.66009.1C	R.66009.2C	
		R							
02-06	2WD, 4WD	F	R.66040	R.66040	R.66040.1S	R.66040.2S	R.66040.1C	R.66040.2C	
		R	R.66045	R.66045	R.66045.1S	R.66045.2S	R.66045.1C	R.66045.2C	
07		F	R.66057	R.66057	R.66057.1S	R.66057.2S	R.66057.1C	R.66057.2C	
		R	R.66065	R.66065	R.66065.1S	R.66065.2S	R.66065.1C	R.66065.2C	
<b>SEVILLE, STS, SLS</b>									
90-91		F	R.62017	R.62017	R.62017.1S	R.62017.2S	R.62017.1C	R.62017.2C	
		R	R.62024	R.62024	R.62024.1S	R.62024.2S	R.62024.1C	R.62024.2C	
92-96		F	R.62050	R.62050	R.62050.1S	R.62050.2S	R.62050.1C	R.62050.2C	
		R	R.62045	R.62045	R.62045.1S	R.62045.2S	R.62045.1C	R.62045.2C	
97		F	R.62055	R.62055	R.62055.1S	R.62055.2S	R.62055.1C	R.62055.2C	
		R	R.62045	R.62045	R.62045.1S	R.62045.2S	R.62045.1C	R.62045.2C	
98-02		F	R.62055	R.62055	R.62055.1S	R.62055.2S	R.62055.1C	R.62055.2C	
		R	R.62064	R.62064	R.62064.1S	R.62064.2S	R.62064.1C	R.62064.2C	
03-04		F	R.62070	R.62070	R.62070.1S	R.62070.2S	R.62070.1C	R.62070.2C	
		R	R.62064	R.62064	R.62064.1S	R.62064.2S	R.62064.1C	R.62064.2C	
05-07	STS STD BRAKE	F	R.62070	R.62070	R.62070.1S	R.62070.2S	R.62070.1C	R.62070.2C	
		R	R.62071	R.62071	R.62071.1S	R.62071.2S	R.62071.1C	R.62071.2C	
05-07	STS PERFORMANCE BRAKE	F	R.62084	R.62084	R.62084.1S	R.62084.2S	R.62084.1C	R.62084.2C	
		R	R.62088	R.62088	R.62088.1S	R.62088.2S	R.62088.1C	R.62088.2C	
06-07	STS-V SUPERCHARGED BREMBO CALIPER	F	R.62075	R.62075	R.62075.1S	R.62075.2S	R.62075.1C	R.62075.2C	
		R	R.62076	R.62076	R.62076.1S	R.62076.2S	R.62076.1C	R.62076.2C	
<b>SRX</b>									
04-07		F	R.62082	R.62082	R.62082.1S	R.62082.2S	R.62082.1C	R.62082.2C	
		R	R.62083	R.62083	R.62083.1S	R.62083.2S	R.62083.1C	R.62083.2C	
<b>STS (SEE SEVILLE, STS, SLS)</b>									
<b>XLR</b>									
04		F	R.62059	R.62060	R.62059.1S	R.62059.2S	R.62059.1C	R.62059.2C	B
		R	R.62061	R.62062	R.62061.1S	R.62061.2S	R.62061.1C	R.62061.2C	B
05-07	EXC XLR-V	F	R.62085	R.62085	R.62085.1S	R.62085.2S	R.62085.1C	R.62085.2C	
		R	R.62061	R.62062	R.62061.1S	R.62061.2S	R.62061.1C	R.62061.2C	B
06-07	XLR-V SUPERCHARGED	F	R.62086	R.62086	R.62086.1S	R.62086.2S	R.62086.1C	R.62086.2C	D
		R	R.62096	R.62096	R.62096.1S	R.62096.2S	R.62096.1C	R.62096.2C	C, D
<b>CHEVROLET</b>									
<b>ASTRO VAN</b>									
90-95	2WD (W/ REAR ABS)	F	R.62012	R.62012	R.62012.1S	R.62012.2S	R.62012.1C	R.62012.2C	
		R							
90-95	2WD (W/ 4 WHEEL ABS)	F	R.66016	R.66016	R.66016.1S	R.66016.2S	R.66016.1C	R.66016.2C	
		R							
90-95	4WD	F	R.66022	R.66022	R.66022.1S	R.66022.2S	R.66022.1C	R.66022.2C	
		R							
96-02	2WD	F	R.66016	R.66016	R.66016.1S	R.66016.2S	R.66016.1C	R.66016.2C	
		R							
96-02	4WD	F	R.66022	R.66022	R.66022.1S	R.66022.2S	R.66022.1C	R.66022.2C	
		R							

BRAKE DISC		BASIC OEM		SLOTTED		DRILLED & SLOTTED		NOTES	
		AXLE	PART #		PART #		PART #		
MAKE/MODEL	YEAR	F/R	LEFT	RIGHT	LEFT	RIGHT	LEFT	RIGHT	
03-05		F	R.66040	R.66040	R.66040.1S	R.66040.2S	R.66040.1C	R.66040.2C	
		R	R.66041	R.66041	R.66041.1S	R.66041.2S	R.66041.1C	R.66041.2C	
<b>AVALANCHE 1500</b>									
02	W/ LIMITED SLIP AXLE	F	R.66040	R.66040	R.66040.1S	R.66040.2S	R.66040.1C	R.66040.2C	
		R	R.66045	R.66045	R.66045.1S	R.66045.2S	R.66045.1C	R.66045.2C	
02	W/O LIMITED SLIP AXLE	F	R.66040	R.66040	R.66040.1S	R.66040.2S	R.66040.1C	R.66040.2C	
		R	R.66041	R.66041	R.66041.1S	R.66041.2S	R.66041.1C	R.66041.2C	
03-06		F	R.66040	R.66040	R.66040.1S	R.66040.2S	R.66040.1C	R.66040.2C	
		R	R.66045	R.66045	R.66045.1S	R.66045.2S	R.66045.1C	R.66045.2C	
07		F	R.66057	R.66057	R.66057.1S	R.66057.2S	R.66057.1C	R.66057.2C	
		R	R.66065	R.66065	R.66065.1S	R.66065.2S	R.66065.1C	R.66065.2C	
<b>AVALANCHE 2500</b>									
02	EXC 2" BODY RAISE	F	R.66042	R.66042	R.66042.1S	R.66042.2S	R.66042.1C	R.66042.2C	
		R	R.66043	R.66043	R.66043.1S	R.66043.2S	R.66043.1C	R.66043.2C	
02	2" BODY RAISE	F	R.66059	R.66059	R.66059.1S	R.66059.2S	R.66059.1C	R.66059.2C	
		R	R.66043	R.66043	R.66043.1S	R.66043.2S	R.66043.1C	R.66043.2C	
03-04	EXC 2" BODY RAISE	F	R.66042	R.66042	R.66042.1S	R.66042.2S	R.66042.1C	R.66042.2C	
		R	R.66044	R.66044	R.66044.1S	R.66044.2S	R.66044.1C	R.66044.2C	
03-04	2" BODY RAISE	F	R.66059	R.66059	R.66059.1S	R.66059.2S	R.66059.1C	R.66059.2C	
		R	R.66044	R.66044	R.66044.1S	R.66044.2S	R.66044.1C	R.66044.2C	
05-06		F	R.66042	R.66042	R.66042.1S	R.66042.2S	R.66042.1C	R.66042.2C	
		R	R.66044	R.66044	R.66044.1S	R.66044.2S	R.66044.1C	R.66044.2C	
07		F	R.66042	R.66042	R.66042.1S	R.66042.2S	R.66042.1C	R.66042.2C	
		R	R.66043	R.66043	R.66043.1S	R.66043.2S	R.66043.1C	R.66043.2C	
<b>BERETTA</b>									
92-96		F	R.62034	R.62034	R.62034.1S	R.62034.2S	R.62034.1C	R.62034.2C	
		R							
<b>CADET (SEE CAVALIER)</b>									
<b>CAMARO</b>									
89-92	W/ REAR DRUM	F	R.62013	R.62013	R.62013.1S	R.62013.2S	R.62013.1C	R.62013.2C	
		R							
89-92	W/ REAR DISC	F	R.62013	R.62013	R.62013.1S	R.62013.2S	R.62013.1C	R.62013.2C	
	EXC 1LE PERFORMANCE PKG	R	R.62033	R.62033	R.62033.1S	R.62033.2S	R.62033.1C	R.62033.2C	
89-92	W/ 1LE PERFORMANCE PKG	F	R.80003	R.80003	R.80003.1S	R.80003.2S	R.80003.1C	R.80003.2C	
		R	R.62033	R.62033	R.62033.1S	R.62033.2S	R.62033.1C	R.62033.2C	
93-97	W/ REAR DRUM	F	R.62050	R.62050	R.62050.1S	R.62050.2S	R.62050.1C	R.62050.2C	
		R							
93-97	W/ REAR DISC	F	R.62050	R.62050	R.62050.1S	R.62050.2S	R.62050.1C	R.62050.2C	
		R	R.62049	R.62049	R.62049.1S	R.62049.2S	R.62049.1C	R.62049.2C	
98-02		F	R.62055	R.62055	R.62055.1S	R.62055.2S	R.62055.1C	R.62055.2C	
		R	R.62065	R.62065	R.62065.1S	R.62065.2S	R.62065.1C	R.62065.2C	
<b>CAPRICE</b>									
91-93		F	R.62035	R.62035	R.62035.1S	R.62035.2S	R.62035.1C	R.62035.2C	
		R							
94-96	W/ REAR DRUM	F	R.62035	R.62035	R.62035.1S	R.62035.2S	R.62035.1C	R.62035.2C	
		R							
94-96	W/ REAR DISC	F	R.62035	R.62035	R.62035.1S	R.62035.2S	R.62035.1C	R.62035.2C	
		R	R.62053	R.62053	R.62053.1S	R.62053.2S	R.62053.1C	R.62053.2C	
<b>CAVALIER</b>									
92-05		F	R.62034	R.62034	R.62034.1S	R.62034.2S	R.62034.1C	R.62034.2C	
		R							
<b>COBALT</b>									
05-07	BASE LS, LT	F	R.62072	R.62072	R.62072.1S	R.62072.2S	R.62072.1C	R.62072.2C	
	4 LUG	R							
05-07	SS SUPERCHARGED	F	R.62078	R.62078	R.62078.1S	R.62078.2S	R.62078.1C	R.62078.2C	
	5 LUG	R	R.62079	R.62079	R.62079.1S	R.62079.2S	R.62079.1C	R.62079.2C	
07	LS, LTZ	F	R.62104	R.62104	R.62104.1S	R.62104.2S	R.62104.1C	R.62104.2C	
	16" WHEEL, 5 LUG	R						c	
<b>COLORADO</b>									
04-07	ALL MODEL	F	R.66056	R.66056	R.66056.1S	R.66056.2S	R.66056.1C	R.66056.2C	
		R							
<b>CORSICA</b>									
91		F	R.62023	R.62023	R.62023.1S	R.62023.2S	R.62023.1C	R.62023.2C	
		R							
92-96		F	R.62034	R.62034	R.62034.1S	R.62034.2S	R.62034.1C	R.62034.2C	
		R							
<b>CORVETTE</b>									
89-95	STD SUSPENSION	F	R.62040	R.62040	R.62040.1S	R.62040.2S	R.62040.1C	R.62040.2C	

BRAKE DISC		BASIC OEM		SLOTTED		DRILLED & SLOTTED		NOTES	
		MAKE/MODEL	AXLE	PART #		PART #			PART #
YEAR		F/R	LEFT	RIGHT	LEFT	RIGHT	LEFT	RIGHT	
89-95	HD SUSPENSION	R	R.62041	R.62041	R.62041.1S	R.62041.2S	R.62041.1C	R.62041.2C	B
		F	R.62046	R.62047	R.62046.1S	R.62046.2S	R.62046.1C	R.62046.2C	
		R	R.62041	R.62041	R.62041.1S	R.62041.2S	R.62041.1C	R.62041.2C	
96		F	R.62046	R.62047	R.62046.1S	R.62046.2S	R.62046.1C	R.62046.2C	B
		R	R.62041	R.62041	R.62041.1S	R.62041.2S	R.62041.1C	R.62041.2C	
97-04		F	R.62059	R.62060	R.62059.1S	R.62059.2S	R.62059.1C	R.62059.2C	B
		R	R.62061	R.62062	R.62061.1S	R.62061.2S	R.62061.1C	R.62061.2C	B
05-07	EXC Z51 PKG	F	R.62085	R.62085	R.62085.1S	R.62085.2S	R.62085.1C	R.62085.2C	
		R	R.62061	R.62062	R.62061.1S	R.62061.2S	R.62061.1C	R.62061.2C	B
05-07	Z51 PKG	F	R.62086	R.62086	R.62086.1S	R.62086.2S	R.62086.1C	R.62086.2C	D
		R	R.62061	R.62062	R.62061.1S	R.62061.2S	R.62061.1C	R.62061.2C	B
06-07	Z06	F	R.62102	R.62102	R.62102.1S	R.62102.2S	R.62102.1C	R.62102.2C	C, D
		R	R.62103	R.62103	R.62103.1S	R.62103.2S	R.62103.1C	R.62103.2C	C, D
<b>C1500 SERIES (1/2 TON) PICKUP 2WD</b>									
90-91	EXC HD	F	R.66010	R.66010	R.66010.1S	R.66010.2S	R.66010.1C	R.66010.2C	
		R							
90-91	HD	F	R.66011	R.66011	R.66011.1S	R.66011.2S	R.66011.1C	R.66011.2C	
		R							
92-94		F	R.66011	R.66011	R.66011.1S	R.66011.2S	R.66011.1C	R.66011.2C	
		R							
95-99		F	R.66025	R.66025	R.66025.1S	R.66025.2S	R.66025.1C	R.66025.2C	
		R							
<b>C2500 SERIES (3/4 TON) PICKUP 2WD</b>									
90-93	11" REAR DRUM BRAKE 7200 LBS. GVW	F	R.66012	R.66012	R.66012.1S	R.66012.2S	R.66012.1C	R.66012.2C	
		R							
90-93	13" REAR DRUM BRAKE 8600 LBS. GVW, W/ REAR WHEEL ABS	F	R.66014	R.66014	R.66014.1S	R.66014.2S	R.66014.1C	R.66014.2C	
		R							
92-93	13" REAR DRUM BRAKE 8600 LBS. GVW, W/ 4 WHEEL ABS	F	R.66027	R.66027	R.66027.1S	R.66027.2S	R.66027.1C	R.66027.2C	
		R							
94-96	11" REAR DRUM BRAKE 7200 LBS. GVW, W/ REAR WHEEL ABS	F	R.66012	R.66012	R.66012.1S	R.66012.2S	R.66012.1C	R.66012.2C	
		R							
94-96	11" REAR DRUM BRAKE 7200 LBS. GVW, W/ 4 WHEEL ABS	F	R.66035	R.66035	R.66035.1S	R.66035.2S	R.66035.1C	R.66035.2C	
		R							
94-96	13" REAR DRUM BRAKE 8600 LBS. GVW, W/ REAR WHEEL ABS	F	R.66014	R.66014	R.66014.1S	R.66014.2S	R.66014.1C	R.66014.2C	
		R							
94-96	13" REAR DRUM BRAKE 8600 LBS. GVW, W/ 4 WHEEL ABS	F	R.66027	R.66027	R.66027.1S	R.66027.2S	R.66027.1C	R.66027.2C	
		R							
97-98	11" REAR DRUM BRAKE 7200 LBS. GVW	F	R.66035	R.66035	R.66035.1S	R.66035.2S	R.66035.1C	R.66035.2C	
		R							
97-00	13" REAR DRUM BRAKE 8600 LBS. GVW	F	R.66027	R.66027	R.66027.1S	R.66027.2S	R.66027.1C	R.66027.2C	
		R							
<b>EQUINOX</b>									
06		F	R.62068	R.62068	R.62068.1S	R.62068.2S	R.62068.1C	R.62068.2C	
		R							
<b>EXPRESS 1500 (1/2 TON) VAN</b>									
96-02		F	R.66025	R.66025	R.66025.1S	R.66025.2S	R.66025.1C	R.66025.2C	
		R							
03-07		F	R.66040	R.66040	R.66040.1S	R.66040.2S	R.66040.1C	R.66040.2C	
		R	R.66045	R.66045	R.66045.1S	R.66045.2S	R.66045.1C	R.66045.2C	
<b>EXPRESS 2500 (3/4 TON) VAN</b>									
96-00	6 LUG	F	R.66035	R.66035	R.66035.1S	R.66035.2S	R.66035.1C	R.66035.2C	
		R							
96-00	8 LUG	F	R.66027	R.66027	R.66027.1S	R.66027.2S	R.66027.1C	R.66027.2C	
		R							
01-02	6 LUG	F	R.66035	R.66035	R.66035.1S	R.66035.2S	R.66035.1C	R.66035.2C	
		R							
01-02	8 LUG (7700-8600 LBS. GVW) GAS	F	R.66027	R.66027	R.66027.1S	R.66027.2S	R.66027.1C	R.66027.2C	
		R							
01-02	8 LUG (7700-8600 LBS. GVW) DIESEL ENG	F	R.66049	R.66049	R.66049.1S	R.66049.2S	R.66049.1C	R.66049.2C	
		R							
03-06	7300 LBS. GVW	F	R.66040	R.66040	R.66040.1S	R.66040.2S	R.66040.1C	R.66040.2C	
		R	R.66054	R.66054	R.66054.1S	R.66054.2S	R.66054.1C	R.66054.2C	
03-07	8500 LBS. PANEL 8600 LBS. GVW PASS	F	R.66042	R.66042	R.66042.1S	R.66042.2S	R.66042.1C	R.66042.2C	
		R	R.66043	R.66043	R.66043.1S	R.66043.2S	R.66043.1C	R.66043.2C	
06-07	8500 LBS. PANEL (DIESEL ENG) 8600 LBS. GVW PASS	F	R.66042	R.66042	R.66042.1S	R.66042.2S	R.66042.1C	R.66042.2C	
		R	R.66044	R.66044	R.66044.1S	R.66044.2S	R.66044.1C	R.66044.2C	
<b>EXPRESS 3500 (1 TON) VAN</b>									
96-00	SRW	F	R.66027	R.66027	R.66027.1S	R.66027.2S	R.66027.1C	R.66027.2C	

BRAKE DISC		BASIC OEM		SLOTTED		DRILLED & SLOTTED		NOTES	
MAKE/MODEL		AXLE	PART #		PART #		PART #		
YEAR		F/R	LEFT	RIGHT	LEFT	RIGHT	LEFT		RIGHT
01	SRW (W/ G315 CAB, CHASSIS)	R F	R.66027	R.66027	R.66027.1S	R.66027.2S	R.66027.1C	R.66027.2C	
01	SRW (EXC G315 CAB, CHASSIS)	F R	R.66049	R.66049	R.66049.1S	R.66049.2S	R.66049.1C	R.66049.2C	
02	SRW	F R	R.66049	R.66049	R.66049.1S	R.66049.2S	R.66049.1C	R.66049.2C	
03	SRW	F R	R.66059 R.66044	R.66059 R.66044	R.66059.1S R.66044.1S	R.66059.2S R.66044.2S	R.66059.1C R.66044.1C	R.66059.2C R.66044.2C	
03	DRW	F R	R.66059 R.66050	R.66059 R.66050	R.66059.1S R.66050.1S	R.66059.2S R.66050.2S	R.66059.1C R.66050.1C	R.66059.2C R.66050.2C	
04-07	SRW (86MM HIGH REAR)	F R	R.66059 R.66043	R.66059 R.66043	R.66059.1S R.66043.1S	R.66059.2S R.66043.2S	R.66059.1C R.66043.1C	R.66059.2C R.66043.2C	
04-07	SRW (91MM HIGH REAR)	F R	R.66059 R.66044	R.66059 R.66044	R.66059.1S R.66044.1S	R.66059.2S R.66044.2S	R.66059.1C R.66044.1C	R.66059.2C R.66044.2C	
04-07	DRW	F R	R.66059 R.66050	R.66059 R.66050	R.66059.1S R.66050.1S	R.66059.2S R.66050.2S	R.66059.1C R.66050.1C	R.66059.2C R.66050.2C	
<b>HHR</b>									
06-07		F R	R.62095	R.62095	R.62095.1S	R.62095.2S	R.62095.1C	R.62095.2C	
<b>IMPALA</b>									
94-96		F R	R.62035 R.62053	R.62035 R.62053	R.62035.1S R.62053.1S	R.62035.2S R.62053.2S	R.62035.1C R.62053.1C	R.62035.2C R.62053.2C	
99-04		F R	R.62055 R.62058	R.62055 R.62058	R.62055.1S R.62058.1S	R.62055.2S R.62058.2S	R.62055.1C R.62058.1C	R.62055.2C R.62058.2C	
05	BASE, LS	F R	R.62087 R.62058	R.62087 R.62058	R.62087.1S R.62058.1S	R.62087.2S R.62058.2S	R.62087.1C R.62058.1C	R.62087.2C R.62058.2C	
05	SS	F R	R.62055 R.62058	R.62055 R.62058	R.62055.1S R.62058.1S	R.62055.2S R.62058.2S	R.62055.1C R.62058.1C	R.62055.2C R.62058.2C	
06-07		F R	R.62098 R.62097	R.62098 R.62097	R.62098.1S R.62097.1S	R.62098.2S R.62097.2S	R.62098.1C R.62097.1C	R.62098.2C R.62097.2C	C C
<b>LUMINA</b>									
90-93		F R	R.62028 R.62029	R.62028 R.62029	R.62028.1S R.62029.1S	R.62028.2S R.62029.2S	R.62028.1C R.62029.1C	R.62028.2C R.62029.2C	
94	W/ REAR DRUM	F R	R.62028	R.62028	R.62028.1S	R.62028.2S	R.62028.1C	R.62028.2C	
94	W/ REAR DISC	F R	R.62028 R.62029	R.62028 R.62029	R.62028.1S R.62029.1S	R.62028.2S R.62029.2S	R.62028.1C R.62029.1C	R.62028.2C R.62029.2C	
95	W/ REAR DRUM (267MM DISC)	F R	R.62028	R.62028	R.62028.1S	R.62028.2S	R.62028.1C	R.62028.2C	
95	W/ REAR DRUM (286MM DISC)	F R	R.62054	R.62054	R.62054.1S	R.62054.2S	R.62054.1C	R.62054.2C	
95	W/ REAR DISC (267MM DISC)	F R	R.62028 R.62051	R.62028 R.62051	R.62028.1S R.62051.1S	R.62028.2S R.62051.2S	R.62028.1C R.62051.1C	R.62028.2C R.62051.2C	
95	W/ REAR DISC (286MM DISC)	F R	R.62054 R.62051	R.62054 R.62051	R.62054.1S R.62051.1S	R.62054.2S R.62051.2S	R.62054.1C R.62051.1C	R.62054.2C R.62051.2C	
96-99	W/ REAR DRUM	F R	R.62054	R.62054	R.62054.1S	R.62054.2S	R.62054.1C	R.62054.2C	
96-99	W/ REAR DISC	F R	R.62054 R.62051	R.62054 R.62051	R.62054.1S R.62051.1S	R.62054.2S R.62051.2S	R.62054.1C R.62051.1C	R.62054.2C R.62051.2C	
00-01		F R	R.62054	R.62054	R.62054.1S	R.62054.2S	R.62054.1C	R.62054.2C	
<b>MALIBU, MALIBU MAXX</b>									
97-03		F R	R.62056	R.62056	R.62056.1S	R.62056.2S	R.62056.1C	R.62056.2C	
04	OLD BODY STYLE	F R	R.62056	R.62056	R.62056.1S	R.62056.2S	R.62056.1C	R.62056.2C	
04	NEW BODY STYLE (EXC MAXX) W/ REAR DRUM	F R	R.62077	R.62077	R.62077.1S	R.62077.2S	R.62077.1C	R.62077.2C	
04	NEW BODY STYLE (EXC MAXX) W/ REAR DISC	F R	R.62077 R.62079	R.62077 R.62079	R.62077.1S R.62079.1S	R.62077.2S R.62079.2S	R.62077.1C R.62079.1C	R.62077.2C R.62079.2C	
04	MAXX (3.5L ENG)	F R	R.62078 R.62079	R.62078 R.62079	R.62078.1S R.62079.1S	R.62078.2S R.62079.2S	R.62078.1C R.62079.1C	R.62078.2C R.62079.2C	
05	OLD BODY STYLE	F R	R.62056	R.62056	R.62056.1S	R.62056.2S	R.62056.1C	R.62056.2C	
05	NEW BODY STYLE (EXC MAXX) W/ REAR DRUM	F R	R.62077	R.62077	R.62077.1S	R.62077.2S	R.62077.1C	R.62077.2C	
05	SEDAN, MAXX (3.5L ENG)	F	R.62078	R.62078	R.62078.1S	R.62078.2S	R.62078.1C	R.62078.2C	

BRAKE DISC		BASIC OEM		SLOTTED		DRILLED & SLOTTED		NOTES
		AXLE	PART #		PART #		PART #	
MAKE/MODEL	YEAR	F/R	LEFT	RIGHT	LEFT	RIGHT	LEFT	RIGHT
06-07	SEDAN (2.2L ENG)	R	R.62079	R.62079	R.62079.1S	R.62079.2S	R.62079.1C	R.62079.2C
		F	R.62077	R.62077	R.62077.1S	R.62077.2S	R.62077.1C	R.62077.2C
		R						
06-07	SEDAN, MAXX 3.5L ENG, 3.9L ENG	F	R.62078	R.62078	R.62078.1S	R.62078.2S	R.62078.1C	R.62078.2C
		R	R.62079	R.62079	R.62079.1S	R.62079.2S	R.62079.1C	R.62079.2C
<b>MONTE CARLO</b>								
95	W/ REAR DRUM (267MM DISC)	F	R.62028	R.62028	R.62028.1S	R.62028.2S	R.62028.1C	R.62028.2C
		R						
95	W/ REAR DRUM (286MM DISC)	F	R.62054	R.62054	R.62054.1S	R.62054.2S	R.62054.1C	R.62054.2C
		R						
95	W/ REAR DISC (267MM DISC)	F	R.62028	R.62028	R.62028.1S	R.62028.2S	R.62028.1C	R.62028.2C
		R	R.62051	R.62051	R.62051.1S	R.62051.2S	R.62051.1C	R.62051.2C
95	W/ REAR DISC (286MM DISC)	F	R.62054	R.62054	R.62054.1S	R.62054.2S	R.62054.1C	R.62054.2C
		R	R.62051	R.62051	R.62051.1S	R.62051.2S	R.62051.1C	R.62051.2C
96-99	W/ REAR DRUM	F	R.62054	R.62054	R.62054.1S	R.62054.2S	R.62054.1C	R.62054.2C
		R						
96-99	W/ REAR DISC	F	R.62054	R.62054	R.62054.1S	R.62054.2S	R.62054.1C	R.62054.2C
		R	R.62051	R.62051	R.62051.1S	R.62051.2S	R.62051.1C	R.62051.2C
00-04		F	R.62055	R.62055	R.62055.1S	R.62055.2S	R.62055.1C	R.62055.2C
		R	R.62058	R.62058	R.62058.1S	R.62058.2S	R.62058.1C	R.62058.2C
05	LS	F	R.62087	R.62087	R.62087.1S	R.62087.2S	R.62087.1C	R.62087.2C
		R	R.62058	R.62058	R.62058.1S	R.62058.2S	R.62058.1C	R.62058.2C
05	SS	F	R.62055	R.62055	R.62055.1S	R.62055.2S	R.62055.1C	R.62055.2C
		R	R.62058	R.62058	R.62058.1S	R.62058.2S	R.62058.1C	R.62058.2C
06-07		F	R.62098	R.62098	R.62098.1S	R.62098.2S	R.62098.1C	R.62098.2C
		R	R.62097	R.62097	R.62097.1S	R.62097.2S	R.62097.1C	R.62097.2C
<b>OPTRA (CANADA)</b>								
04-06	W/ REAR DRUM	F	R.49009	R.49009	R.49009.1S	R.49009.2S	R.49009.1C	R.49009.2C
		R						
04-06	W/ REAR DISC	F	R.49009	R.49009	R.49009.1S	R.49009.2S	R.49009.1C	R.49009.2C
		R	R.49010	R.49010	R.49010.1S	R.49010.2S	R.49010.1C	R.49010.2C
<b>PRIZM</b>								
98-02		F	R.44092	R.44092	R.44092.1S	R.44092.2S	R.44092.1C	R.44092.2C
		R						
<b>SILVERADO 1500 (1/2 TON) 2WD</b>								
99-00		F	R.66040	R.66040	R.66040.1S	R.66040.2S	R.66040.1C	R.66040.2C
		R	R.66041	R.66041	R.66041.1S	R.66041.2S	R.66041.1C	R.66041.2C
01	2 DR	F	R.66040	R.66040	R.66040.1S	R.66040.2S	R.66040.1C	R.66040.2C
		R	R.66041	R.66041	R.66041.1S	R.66041.2S	R.66041.1C	R.66041.2C
01	4 DR (HD)	F	R.66042	R.66042	R.66042.1S	R.66042.2S	R.66042.1C	R.66042.2C
		R	R.66043	R.66043	R.66043.1S	R.66043.2S	R.66043.1C	R.66043.2C
02	REG CAB (2 WHEEL STEERING)	F	R.66040	R.66040	R.66040.1S	R.66040.2S	R.66040.1C	R.66040.2C
		R	R.66041	R.66041	R.66041.1S	R.66041.2S	R.66041.1C	R.66041.2C
02	EXT CAB (4 WHEEL STEERING)	F	R.66040	R.66040	R.66040.1S	R.66040.2S	R.66040.1C	R.66040.2C
		R	R.66045	R.66045	R.66045.1S	R.66045.2S	R.66045.1C	R.66045.2C
02	4 DR (HD)	F	R.66042	R.66042	R.66042.1S	R.66042.2S	R.66042.1C	R.66042.2C
		R	R.66043	R.66043	R.66043.1S	R.66043.2S	R.66043.1C	R.66043.2C
03	REG CAB	F	R.66040	R.66040	R.66040.1S	R.66040.2S	R.66040.1C	R.66040.2C
		R	R.66041	R.66041	R.66041.1S	R.66041.2S	R.66041.1C	R.66041.2C
03	EXT CAB (2 WHEEL STEERING)	F	R.66040	R.66040	R.66040.1S	R.66040.2S	R.66040.1C	R.66040.2C
		R	R.66041	R.66041	R.66041.1S	R.66041.2S	R.66041.1C	R.66041.2C
03	EXT CAB (4 WHEEL STEERING) 330MM REAR DISC	F	R.66040	R.66040	R.66040.1S	R.66040.2S	R.66040.1C	R.66040.2C
		R	R.66045	R.66045	R.66045.1S	R.66045.2S	R.66045.1C	R.66045.2C
03	EXT CAB (4 WHEEL STEERING) 325MM REAR DISC	F	R.66040	R.66040	R.66040.1S	R.66040.2S	R.66040.1C	R.66040.2C
		R	R.66041	R.66041	R.66041.1S	R.66041.2S	R.66041.1C	R.66041.2C
03	CREW CAB (4 DR) HD 2 WHEEL STEERING	F	R.66042	R.66042	R.66042.1S	R.66042.2S	R.66042.1C	R.66042.2C
		R	R.66043	R.66043	R.66043.1S	R.66043.2S	R.66043.1C	R.66043.2C
03	CREW CAB (4 DR) HD 4 WHEEL STEERING	F	R.66042	R.66042	R.66042.1S	R.66042.2S	R.66042.1C	R.66042.2C
		R	R.66041	R.66041	R.66041.1S	R.66041.2S	R.66041.1C	R.66041.2C
04	REG CAB	F	R.66040	R.66040	R.66040.1S	R.66040.2S	R.66040.1C	R.66040.2C
		R	R.66041	R.66041	R.66041.1S	R.66041.2S	R.66041.1C	R.66041.2C
04	CREW CAB	F	R.66040	R.66040	R.66040.1S	R.66040.2S	R.66040.1C	R.66040.2C
		R	R.66045	R.66045	R.66045.1S	R.66045.2S	R.66045.1C	R.66045.2C
04	EXT CAB (STD DUTY) 2 WHEEL STEERING	F	R.66040	R.66040	R.66040.1S	R.66040.2S	R.66040.1C	R.66040.2C
		R	R.66041	R.66041	R.66041.1S	R.66041.2S	R.66041.1C	R.66041.2C
04	EXT CAB (STD DUTY) 4 WHEEL STEERING	F	R.66040	R.66040	R.66040.1S	R.66040.2S	R.66040.1C	R.66040.2C
		R	R.66045	R.66045	R.66045.1S	R.66045.2S	R.66045.1C	R.66045.2C
04	EXT CAB (HYBRID ELECTRIC)	F	R.66040	R.66040	R.66040.1S	R.66040.2S	R.66040.1C	R.66040.2C

BRAKE DISC		BASIC OEM		SLOTTED		DRILLED & SLOTTED		NOTES	
MAKE/MODEL		AXLE	PART #		PART #		PART #		
YEAR		F/R	LEFT	RIGHT	LEFT	RIGHT	LEFT		RIGHT
		R	R.66041	R.66041	R.66041.1S	R.66041.2S	R.66041.1C	R.66041.2C	
04	EXT CAB (HD)	F	R.66042	R.66042	R.66042.1S	R.66042.2S	R.66042.1C	R.66042.2C	
	4.63" REAR HUB HOLE	R	R.66043	R.66043	R.66043.1S	R.66043.2S	R.66043.1C	R.66043.2C	
04	EXT CAB (HD)	F	R.66042	R.66042	R.66042.1S	R.66042.2S	R.66042.1C	R.66042.2C	
	4.83" REAR HUB HOLE	R	R.66044	R.66044	R.66044.1S	R.66044.2S	R.66044.1C	R.66044.2C	
05	W/ REAR DRUM	F	R.66057	R.66057	R.66057.1S	R.66057.2S	R.66057.1C	R.66057.2C	
		R							
05	HD CREW CAB (W/O QUADRASTEER)	F	R.66042	R.66042	R.66042.1S	R.66042.2S	R.66042.1C	R.66042.2C	
		R	R.66043	R.66043	R.66043.1S	R.66043.2S	R.66043.1C	R.66043.2C	
05	HD CREW CAB (W/ QUADRASTEER)	F	R.66042	R.66042	R.66042.1S	R.66042.2S	R.66042.1C	R.66042.2C	
		R	R.66055	R.66055	R.66055.1S	R.66055.2S	R.66055.1C	R.66055.2C	
05	EXT CAB (HYBRID ELECTRIC)	F	R.66040	R.66040	R.66040.1S	R.66040.2S	R.66040.1C	R.66040.2C	
		R	R.66041	R.66041	R.66041.1S	R.66041.2S	R.66041.1C	R.66041.2C	
06	W/ REAR DRUM	F	R.66057	R.66057	R.66057.1S	R.66057.2S	R.66057.1C	R.66057.2C	
		R							
06	REG, EXT CAB	F	R.66040	R.66040	R.66040.1S	R.66040.2S	R.66040.1C	R.66040.2C	
	W/ 6400 & 7000 LBS. REAR AXLE	R	R.66041	R.66041	R.66041.1S	R.66041.2S	R.66041.1C	R.66041.2C	
06	HD CREW CAB	F	R.66042	R.66042	R.66042.1S	R.66042.2S	R.66042.1C	R.66042.2C	
		R	R.66043	R.66043	R.66043.1S	R.66043.2S	R.66043.1C	R.66043.2C	
06	EXT CAB (SS-6.0L V8)	F	R.66040	R.66040	R.66040.1S	R.66040.2S	R.66040.1C	R.66040.2C	
		R	R.66045	R.66045	R.66045.1S	R.66045.2S	R.66045.1C	R.66045.2C	
07	W/ REAR DRUM	F	R.66057	R.66057	R.66057.1S	R.66057.2S	R.66057.1C	R.66057.2C	
		R							
07	W/ REAR DISC	F	R.66057	R.66057	R.66057.1S	R.66057.2S	R.66057.1C	R.66057.2C	
		R	R.66065	R.66065	R.66065.1S	R.66065.2S	R.66065.1C	R.66065.2C	
<b>SILVERADO 1500 (1/2 TON) 4WD</b>									
99-00		F	R.66040	R.66040	R.66040.1S	R.66040.2S	R.66040.1C	R.66040.2C	
		R	R.66041	R.66041	R.66041.1S	R.66041.2S	R.66041.1C	R.66041.2C	
01-02	REG CAB	F	R.66040	R.66040	R.66040.1S	R.66040.2S	R.66040.1C	R.66040.2C	
		R	R.66041	R.66041	R.66041.1S	R.66041.2S	R.66041.1C	R.66041.2C	
01-02	EXT CAB	F	R.66040	R.66040	R.66040.1S	R.66040.2S	R.66040.1C	R.66040.2C	
		R	R.66045	R.66045	R.66045.1S	R.66045.2S	R.66045.1C	R.66045.2C	
01-02	4 DR (HD)	F	R.66042	R.66042	R.66042.1S	R.66042.2S	R.66042.1C	R.66042.2C	
		R	R.66043	R.66043	R.66043.1S	R.66043.2S	R.66043.1C	R.66043.2C	
03	REG CAB	F	R.66040	R.66040	R.66040.1S	R.66040.2S	R.66040.1C	R.66040.2C	
		R	R.66041	R.66041	R.66041.1S	R.66041.2S	R.66041.1C	R.66041.2C	
03	EXT CAB (2 WHEEL STEERING)	F	R.66040	R.66040	R.66040.1S	R.66040.2S	R.66040.1C	R.66040.2C	
		R	R.66041	R.66041	R.66041.1S	R.66041.2S	R.66041.1C	R.66041.2C	
03	EXT CAB (4 WHEEL STEERING)	F	R.66040	R.66040	R.66040.1S	R.66040.2S	R.66040.1C	R.66040.2C	
	330MM REAR DISC	R	R.66045	R.66045	R.66045.1S	R.66045.2S	R.66045.1C	R.66045.2C	
03	EXT CAB (4 WHEEL STEERING)	F	R.66040	R.66040	R.66040.1S	R.66040.2S	R.66040.1C	R.66040.2C	
	325MM REAR DISC	R	R.66041	R.66041	R.66041.1S	R.66041.2S	R.66041.1C	R.66041.2C	
03	CREW CAB (4 DR) HD	F	R.66042	R.66042	R.66042.1S	R.66042.2S	R.66042.1C	R.66042.2C	
	2 WHEEL STEERING	R	R.66043	R.66043	R.66043.1S	R.66043.2S	R.66043.1C	R.66043.2C	
03	CREW CAB (4 DR) HD	F	R.66042	R.66042	R.66042.1S	R.66042.2S	R.66042.1C	R.66042.2C	
	4 WHEEL STEERING	R	R.66055	R.66055	R.66055.1S	R.66055.2S	R.66055.1C	R.66055.2C	
04	REG CAB	F	R.66040	R.66040	R.66040.1S	R.66040.2S	R.66040.1C	R.66040.2C	
		R	R.66041	R.66041	R.66041.1S	R.66041.2S	R.66041.1C	R.66041.2C	
04	CREW CAB	F	R.66040	R.66040	R.66040.1S	R.66040.2S	R.66040.1C	R.66040.2C	
		R	R.66045	R.66045	R.66045.1S	R.66045.2S	R.66045.1C	R.66045.2C	
04	EXT CAB (STD DUTY)	F	R.66040	R.66040	R.66040.1S	R.66040.2S	R.66040.1C	R.66040.2C	
	2 WHEEL STEERING	R	R.66041	R.66041	R.66041.1S	R.66041.2S	R.66041.1C	R.66041.2C	
04	EXT CAB (STD DUTY)	F	R.66040	R.66040	R.66040.1S	R.66040.2S	R.66040.1C	R.66040.2C	
	4 WHEEL STEERING	R	R.66045	R.66045	R.66045.1S	R.66045.2S	R.66045.1C	R.66045.2C	
04	EXT CAB (HYBRID ELECTRIC)	F	R.66040	R.66040	R.66040.1S	R.66040.2S	R.66040.1C	R.66040.2C	
		R	R.66041	R.66041	R.66041.1S	R.66041.2S	R.66041.1C	R.66041.2C	
04	EXT CAB (HD)	F	R.66042	R.66042	R.66042.1S	R.66042.2S	R.66042.1C	R.66042.2C	
	4.63" REAR HUB HOLE	R	R.66043	R.66043	R.66043.1S	R.66043.2S	R.66043.1C	R.66043.2C	
04	EXT CAB (HD)	F	R.66042	R.66042	R.66042.1S	R.66042.2S	R.66042.1C	R.66042.2C	
	4.83" REAR HUB HOLE	R	R.66044	R.66044	R.66044.1S	R.66044.2S	R.66044.1C	R.66044.2C	
04	EXT CAB (SS-6.0L V8)	F	R.66040	R.66040	R.66040.1S	R.66040.2S	R.66040.1C	R.66040.2C	
		R	R.66045	R.66045	R.66045.1S	R.66045.2S	R.66045.1C	R.66045.2C	
05	W/ REAR DRUM	F	R.66057	R.66057	R.66057.1S	R.66057.2S	R.66057.1C	R.66057.2C	
		R							
05	HD CREW CAB (W/O QUADRASTEER)	F	R.66042	R.66042	R.66042.1S	R.66042.2S	R.66042.1C	R.66042.2C	
		R	R.66043	R.66043	R.66043.1S	R.66043.2S	R.66043.1C	R.66043.2C	
05	HD CREW CAB (W/ QUADRASTEER)	F	R.66042	R.66042	R.66042.1S	R.66042.2S	R.66042.1C	R.66042.2C	
		R	R.66055	R.66055	R.66055.1S	R.66055.2S	R.66055.1C	R.66055.2C	



BRAKE DISC		BASIC OEM		SLOTTED		DRILLED & SLOTTED		NOTES	
		AXLE	PART #		PART #		PART #		
MAKE/MODEL	YEAR	F/R	LEFT	RIGHT	LEFT	RIGHT	LEFT	RIGHT	
05	EXT CAB (HYBRID ELECTRIC)	F	R.66040	R.66040	R.66040.1S	R.66040.2S	R.66040.1C	R.66040.2C	
		R	R.66041	R.66041	R.66041.1S	R.66041.2S	R.66041.1C	R.66041.2C	
05	EXT CAB (SS-6.0L V8)	F	R.66040	R.66040	R.66040.1S	R.66040.2S	R.66040.1C	R.66040.2C	
		R	R.66045	R.66045	R.66045.1S	R.66045.2S	R.66045.1C	R.66045.2C	
06	W/ REAR DRUM	F	R.66057	R.66057	R.66057.1S	R.66057.2S	R.66057.1C	R.66057.2C	
		R							
06	REG, EXT CAB W/ 6400 & 7000 LBS. REAR AXLE	F	R.66040	R.66040	R.66040.1S	R.66040.2S	R.66040.1C	R.66040.2C	
		R	R.66041	R.66041	R.66041.1S	R.66041.2S	R.66041.1C	R.66041.2C	
06	HD CREW CAB	F	R.66042	R.66042	R.66042.1S	R.66042.2S	R.66042.1C	R.66042.2C	
		R	R.66043	R.66043	R.66043.1S	R.66043.2S	R.66043.1C	R.66043.2C	
06	EXT CAB (SS-6.0L V8)	F	R.66040	R.66040	R.66040.1S	R.66040.2S	R.66040.1C	R.66040.2C	
		R	R.66045	R.66045	R.66045.1S	R.66045.2S	R.66045.1C	R.66045.2C	
07	W/ REAR DRUM	F	R.66057	R.66057	R.66057.1S	R.66057.2S	R.66057.1C	R.66057.2C	
		R							
07	W/ REAR DISC	F	R.66057	R.66057	R.66057.1S	R.66057.2S	R.66057.1C	R.66057.2C	
		R	R.66065	R.66065	R.66065.1S	R.66065.2S	R.66065.1C	R.66065.2C	
<b>SILVERADO 2500 (3/4 TON) 2WD &amp; 4WD</b>									
99-00		F	R.66042	R.66042	R.66042.1S	R.66042.2S	R.66042.1C	R.66042.2C	
		R	R.66043	R.66043	R.66043.1S	R.66043.2S	R.66043.1C	R.66043.2C	
01-03	EXC HD (A/T)	F	R.66042	R.66042	R.66042.1S	R.66042.2S	R.66042.1C	R.66042.2C	
		R	R.66043	R.66043	R.66043.1S	R.66043.2S	R.66043.1C	R.66043.2C	
01-03	EXC HD (M/T)	F	R.66042	R.66042	R.66042.1S	R.66042.2S	R.66042.1C	R.66042.2C	
		R	R.66044	R.66044	R.66044.1S	R.66044.2S	R.66044.1C	R.66044.2C	
01-03	HD	F	R.66059	R.66059	R.66059.1S	R.66059.2S	R.66059.1C	R.66059.2C	
		R	R.66044	R.66044	R.66044.1S	R.66044.2S	R.66044.1C	R.66044.2C	
04	EXC HD (A/T)	F	R.66042	R.66042	R.66042.1S	R.66042.2S	R.66042.1C	R.66042.2C	
		R	R.66043	R.66043	R.66043.1S	R.66043.2S	R.66043.1C	R.66043.2C	
04	EXC HD (M/T)	F	R.66042	R.66042	R.66042.1S	R.66042.2S	R.66042.1C	R.66042.2C	
		R	R.66044	R.66044	R.66044.1S	R.66044.2S	R.66044.1C	R.66044.2C	
04	HD (2 WHEEL STEERING)	F	R.66059	R.66059	R.66059.1S	R.66059.2S	R.66059.1C	R.66059.2C	
		R	R.66044	R.66044	R.66044.1S	R.66044.2S	R.66044.1C	R.66044.2C	
04	HD (4 WHEEL STEERING)	F	R.66059	R.66059	R.66059.1S	R.66059.2S	R.66059.1C	R.66059.2C	
		R	R.66055	R.66055	R.66055.1S	R.66055.2S	R.66055.1C	R.66055.2C	
05	EXC HD	F	R.66042	R.66042	R.66042.1S	R.66042.2S	R.66042.1C	R.66042.2C	
		R	R.66044	R.66044	R.66044.1S	R.66044.2S	R.66044.1C	R.66044.2C	
05	HD	F	R.66059	R.66059	R.66059.1S	R.66059.2S	R.66059.1C	R.66059.2C	
		R	R.66044	R.66044	R.66044.1S	R.66044.2S	R.66044.1C	R.66044.2C	
06-07		F	R.66059	R.66059	R.66059.1S	R.66059.2S	R.66059.1C	R.66059.2C	
		R	R.66044	R.66044	R.66044.1S	R.66044.2S	R.66044.1C	R.66044.2C	
<b>SILVERADO 3500 (1 TON) 2WD</b>									
01-05		F	R.66059	R.66059	R.66059.1S	R.66059.2S	R.66059.1C	R.66059.2C	
		R	R.66050	R.66050	R.66050.1S	R.66050.2S	R.66050.1C	R.66050.2C	
06-07	SRW	F	R.66059	R.66059	R.66059.1S	R.66059.2S	R.66059.1C	R.66059.2C	
		R	R.66044	R.66044	R.66044.1S	R.66044.2S	R.66044.1C	R.66044.2C	
06-07	DRW	F	R.66059	R.66059	R.66059.1S	R.66059.2S	R.66059.1C	R.66059.2C	
		R	R.66050	R.66050	R.66050.1S	R.66050.2S	R.66050.1C	R.66050.2C	
<b>SILVERADO 3500 (1 TON) 4WD</b>									
01-03		F	R.66059	R.66059	R.66059.1S	R.66059.2S	R.66059.1C	R.66059.2C	
		R	R.66050	R.66050	R.66050.1S	R.66050.2S	R.66050.1C	R.66050.2C	
04-07	SRW	F	R.66059	R.66059	R.66059.1S	R.66059.2S	R.66059.1C	R.66059.2C	
		R	R.66044	R.66044	R.66044.1S	R.66044.2S	R.66044.1C	R.66044.2C	
04-07	DRW	F	R.66059	R.66059	R.66059.1S	R.66059.2S	R.66059.1C	R.66059.2C	
		R	R.66050	R.66050	R.66050.1S	R.66050.2S	R.66050.1C	R.66050.2C	
<b>SSR</b>									
03-05		F	R.66053	R.66053	R.66053.1S	R.66053.2S	R.66053.1C	R.66053.2C	A
		R	R.66052	R.66052	R.66052.1S	R.66052.2S	R.66052.1C	R.66052.2C	A
06-07		F	R.66063	R.66063	R.66063.1S	R.66063.2S	R.66063.1C	R.66063.2C	A
		R	R.66052	R.66052	R.66052.1S	R.66052.2S	R.66052.1C	R.66052.2C	A
<b>SUBURBAN 1500 (1/2 TON) 2WD &amp; 4WD</b>									
92-93		F	R.66025	R.66025	R.66025.1S	R.66025.2S	R.66025.1C	R.66025.2C	
		R							
94-99	11" REAR DRUM BRAKE (6 LUG)	F	R.66025	R.66025	R.66025.1S	R.66025.2S	R.66025.1C	R.66025.2C	
94-99	13" REAR DRUM BRAKE (8 LUG)	F	R.66027	R.66027	R.66027.1S	R.66027.2S	R.66027.1C	R.66027.2C	
		R							
00	11" REAR DRUM BRAKE (6 LUG)	F	R.66025	R.66025	R.66025.1S	R.66025.2S	R.66025.1C	R.66025.2C	
		R							
00	13" REAR DRUM BRAKE (8 LUG)	F	R.66027	R.66027	R.66027.1S	R.66027.2S	R.66027.1C	R.66027.2C	

BRAKE DISC		BASIC OEM		SLOTTED		DRILLED & SLOTTED		NOTES	
MAKE/MODEL		AXLE	PART #		PART #		PART #		
YEAR		F/R	LEFT	RIGHT	LEFT	RIGHT	LEFT		RIGHT
		R							
00	W/ LIMITED SLIP AXLE	F	R.66040	R.66040	R.66040.1S	R.66040.2S	R.66040.1C	R.66040.2C	
		R	R.66045	R.66045	R.66045.1S	R.66045.2S	R.66045.1C	R.66045.2C	
00	W/O LIMITED SLIP AXLE	F	R.66040	R.66040	R.66040.1S	R.66040.2S	R.66040.1C	R.66040.2C	
		R	R.66041	R.66041	R.66041.1S	R.66041.2S	R.66041.1C	R.66041.2C	
01-02	W/ LIMITED SLIP AXLE	F	R.66040	R.66040	R.66040.1S	R.66040.2S	R.66040.1C	R.66040.2C	
		R	R.66045	R.66045	R.66045.1S	R.66045.2S	R.66045.1C	R.66045.2C	
01-02	W/O LIMITED SLIP AXLE	F	R.66040	R.66040	R.66040.1S	R.66040.2S	R.66040.1C	R.66040.2C	
		R	R.66041	R.66041	R.66041.1S	R.66041.2S	R.66041.1C	R.66041.2C	
03-06		F	R.66040	R.66040	R.66040.1S	R.66040.2S	R.66040.1C	R.66040.2C	
		R	R.66045	R.66045	R.66045.1S	R.66045.2S	R.66045.1C	R.66045.2C	
07		F	R.66057	R.66057	R.66057.1S	R.66057.2S	R.66057.1C	R.66057.2C	
		R	R.66065	R.66065	R.66065.1S	R.66065.2S	R.66065.1C	R.66065.2C	
<b>SUBURBAN 2500 (3/4 TON) 2WD</b>									
92-99		F	R.66027	R.66027	R.66027.1S	R.66027.2S	R.66027.1C	R.66027.2C	
		R							
00	W/ REAR DRUM	F	R.66027	R.66027	R.66027.1S	R.66027.2S	R.66027.1C	R.66027.2C	
		R							
00	W/ REAR DISC (4.63" REAR HUB HOLE)	F	R.66042	R.66042	R.66042.1S	R.66042.2S	R.66042.1C	R.66042.2C	
		R	R.66043	R.66043	R.66043.1S	R.66043.2S	R.66043.1C	R.66043.2C	
00	W/ REAR DISC (4.83" REAR HUB HOLE)	F	R.66042	R.66042	R.66042.1S	R.66042.2S	R.66042.1C	R.66042.2C	
		R	R.66044	R.66044	R.66044.1S	R.66044.2S	R.66044.1C	R.66044.2C	
01-05	2 WHEEL STEERING (W/ REAR DISC) 4.63" REAR HUB HOLE	F	R.66042	R.66042	R.66042.1S	R.66042.2S	R.66042.1C	R.66042.2C	
		R	R.66043	R.66043	R.66043.1S	R.66043.2S	R.66043.1C	R.66043.2C	
01-05	2 WHEEL STEERING (W/ REAR DISC) 4.83" REAR HUB HOLE	F	R.66042	R.66042	R.66042.1S	R.66042.2S	R.66042.1C	R.66042.2C	
		R	R.66044	R.66044	R.66044.1S	R.66044.2S	R.66044.1C	R.66044.2C	
03-05	4 WHEEL STEERING	F	R.66042	R.66042	R.66042.1S	R.66042.2S	R.66042.1C	R.66042.2C	
		R	R.66041	R.66041	R.66041.1S	R.66041.2S	R.66041.1C	R.66041.2C	
06	4.63" REAR HUB HOLE	F	R.66042	R.66042	R.66042.1S	R.66042.2S	R.66042.1C	R.66042.2C	
		R	R.66043	R.66043	R.66043.1S	R.66043.2S	R.66043.1C	R.66043.2C	
06	4.83" REAR HUB HOLE	F	R.66042	R.66042	R.66042.1S	R.66042.2S	R.66042.1C	R.66042.2C	
		R	R.66044	R.66044	R.66044.1S	R.66044.2S	R.66044.1C	R.66044.2C	
07		F	R.66042	R.66042	R.66042.1S	R.66042.2S	R.66042.1C	R.66042.2C	
		R	R.66043	R.66043	R.66043.1S	R.66043.2S	R.66043.1C	R.66043.2C	
<b>SUBURBAN 2500 (3/4 TON) 4WD</b>									
92-99		F	R.66042	R.66042	R.66042.1S	R.66042.2S	R.66042.1C	R.66042.2C	
		R							
00	W/ REAR DRUM	F	R.66042	R.66042	R.66042.1S	R.66042.2S	R.66042.1C	R.66042.2C	
		R							
00	W/ REAR DISC (4.63" REAR HUB HOLE)	F	R.66042	R.66042	R.66042.1S	R.66042.2S	R.66042.1C	R.66042.2C	
		R	R.66043	R.66043	R.66043.1S	R.66043.2S	R.66043.1C	R.66043.2C	
00	W/ REAR DISC (4.83" REAR HUB HOLE)	F	R.66042	R.66042	R.66042.1S	R.66042.2S	R.66042.1C	R.66042.2C	
		R	R.66044	R.66044	R.66044.1S	R.66044.2S	R.66044.1C	R.66044.2C	
01-05	2 WHEEL STEERING (W/ REAR DISC) 4.63" REAR HUB HOLE	F	R.66042	R.66042	R.66042.1S	R.66042.2S	R.66042.1C	R.66042.2C	
		R	R.66043	R.66043	R.66043.1S	R.66043.2S	R.66043.1C	R.66043.2C	
01-05	2 WHEEL STEERING (W/ REAR DISC) 4.83" REAR HUB HOLE	F	R.66042	R.66042	R.66042.1S	R.66042.2S	R.66042.1C	R.66042.2C	
		R	R.66044	R.66044	R.66044.1S	R.66044.2S	R.66044.1C	R.66044.2C	
03-05	4 WHEEL STEERING	F	R.66042	R.66042	R.66042.1S	R.66042.2S	R.66042.1C	R.66042.2C	
		R	R.66041	R.66041	R.66041.1S	R.66041.2S	R.66041.1C	R.66041.2C	
06	4.63" REAR HUB HOLE	F	R.66042	R.66042	R.66042.1S	R.66042.2S	R.66042.1C	R.66042.2C	
		R	R.66043	R.66043	R.66043.1S	R.66043.2S	R.66043.1C	R.66043.2C	
06	4.83" REAR HUB HOLE	F	R.66042	R.66042	R.66042.1S	R.66042.2S	R.66042.1C	R.66042.2C	
		R	R.66044	R.66044	R.66044.1S	R.66044.2S	R.66044.1C	R.66044.2C	
07		F	R.66042	R.66042	R.66042.1S	R.66042.2S	R.66042.1C	R.66042.2C	
		R	R.66043	R.66043	R.66043.1S	R.66043.2S	R.66043.1C	R.66043.2C	
<b>S-10 BLAZER SUV (2WD)</b>									
89-90		F	R.62013	R.62013	R.62013.1S	R.62013.2S	R.62013.1C	R.62013.2C	
		R							
91-95	W/O 4 WHEEL ABS	F	R.62013	R.62013	R.62013.1S	R.62013.2S	R.62013.1C	R.62013.2C	
		R							
91-95	W/ 4 WHEEL ABS	F	R.66017	R.66017	R.66017.1S	R.66017.2S	R.66017.1C	R.66017.2C	
		R							
96-97		F	R.66017	R.66017	R.66017.1S	R.66017.2S	R.66017.1C	R.66017.2C	
		R							
98-03		F	R.66038	R.66038	R.66038.1S	R.66038.2S	R.66038.1C	R.66038.2C	
		R	R.66039	R.66039	R.66039.1S	R.66039.2S	R.66039.1C	R.66039.2C	
04-05	ZR2	F	R.66038	R.66038	R.66038.1S	R.66038.2S	R.66038.1C	R.66038.2C	
		R	R.66036	R.66036	R.66036.1S	R.66036.2S	R.66036.1C	R.66036.2C	

BRAKE DISC		BASIC OEM		SLOTTED		DRILLED & SLOTTED		NOTES	
		AXLE	PART #		PART #		PART #		
MAKE/MODEL	YEAR	F/R	LEFT	RIGHT	LEFT	RIGHT	LEFT	RIGHT	
04-05	EXC ZR2	F	R.66038	R.66038	R.66038.1S	R.66038.2S	R.66038.1C	R.66038.2C	
		R	R.66039	R.66039	R.66039.1S	R.66039.2S	R.66039.1C	R.66039.2C	
<b>S-10 (T-10) BLAZER SUV (4WD)</b>									
89-96		F	R.66006	R.66006	R.66006.1S	R.66006.2S	R.66006.1C	R.66006.2C	
		R							
97	W/ REAR DRUM	F	R.66006	R.66006	R.66006.1S	R.66006.2S	R.66006.1C	R.66006.2C	
		R							
97	W/ REAR DISC	F	R.66038	R.66038	R.66038.1S	R.66038.2S	R.66038.1C	R.66038.2C	
		R	R.66036	R.66036	R.66036.1S	R.66036.2S	R.66036.1C	R.66036.2C	
98-01		F	R.66038	R.66038	R.66038.1S	R.66038.2S	R.66038.1C	R.66038.2C	
		R	R.66036	R.66036	R.66036.1S	R.66036.2S	R.66036.1C	R.66036.2C	
02-03	2 DR (A/T)	F	R.66038	R.66038	R.66038.1S	R.66038.2S	R.66038.1C	R.66038.2C	
		R	R.66039	R.66039	R.66039.1S	R.66039.2S	R.66039.1C	R.66039.2C	
02-03	2 DR (M/T)	F	R.66038	R.66038	R.66038.1S	R.66038.2S	R.66038.1C	R.66038.2C	
		R	R.66036	R.66036	R.66036.1S	R.66036.2S	R.66036.1C	R.66036.2C	
02-03	4 DR (A/T)	F	R.66038	R.66038	R.66038.1S	R.66038.2S	R.66038.1C	R.66038.2C	
		R	R.66039	R.66039	R.66039.1S	R.66039.2S	R.66039.1C	R.66039.2C	
04	2 DR (EXC ZR2) M/T	F	R.66038	R.66038	R.66038.1S	R.66038.2S	R.66038.1C	R.66038.2C	
		R	R.66036	R.66036	R.66036.1S	R.66036.2S	R.66036.1C	R.66036.2C	
04	2 DR (EXC ZR2) A/T	F	R.66038	R.66038	R.66038.1S	R.66038.2S	R.66038.1C	R.66038.2C	
		R	R.66039	R.66039	R.66039.1S	R.66039.2S	R.66039.1C	R.66039.2C	
04	2DR (ZR2)	F	R.66038	R.66038	R.66038.1S	R.66038.2S	R.66038.1C	R.66038.2C	
		R	R.66036	R.66036	R.66036.1S	R.66036.2S	R.66036.1C	R.66036.2C	
04	4 DR (A/T)	F	R.66038	R.66038	R.66038.1S	R.66038.2S	R.66038.1C	R.66038.2C	
		R	R.66039	R.66039	R.66039.1S	R.66039.2S	R.66039.1C	R.66039.2C	
05	2 DR (EXC ZR2) M/T	F	R.66038	R.66038	R.66038.1S	R.66038.2S	R.66038.1C	R.66038.2C	
		R	R.66036	R.66036	R.66036.1S	R.66036.2S	R.66036.1C	R.66036.2C	
05	2 DR (EXC ZR2) A/T	F	R.66038	R.66038	R.66038.1S	R.66038.2S	R.66038.1C	R.66038.2C	
		R	R.66039	R.66039	R.66039.1S	R.66039.2S	R.66039.1C	R.66039.2C	
05	2DR (ZR2)	F	R.66038	R.66038	R.66038.1S	R.66038.2S	R.66038.1C	R.66038.2C	
		R	R.66036	R.66036	R.66036.1S	R.66036.2S	R.66036.1C	R.66036.2C	
<b>S-10 PICKUP (2WD)</b>									
89-90		F	R.62013	R.62013	R.62013.1S	R.62013.2S	R.62013.1C	R.62013.2C	
		R							
91-95	W/O 4 WHEEL ABS	F	R.62013	R.62013	R.62013.1S	R.62013.2S	R.62013.1C	R.62013.2C	
		R							
91-95	W/ 4 WHEEL ABS	F	R.66017	R.66017	R.66017.1S	R.66017.2S	R.66017.1C	R.66017.2C	
		R							
96-97	EXC ELECTRIC PICKUP	F	R.66017	R.66017	R.66017.1S	R.66017.2S	R.66017.1C	R.66017.2C	
		R							
96-97	ELECTRIC PICKUP	F	R.66006	R.66006	R.66006.1S	R.66006.2S	R.66006.1C	R.66006.2C	
		R							
98-03		F	R.66017	R.66017	R.66017.1S	R.66017.2S	R.66017.1C	R.66017.2C	
		R							
04		F	R.66038	R.66038	R.66038.1S	R.66038.2S	R.66038.1C	R.66038.2C	
		R	R.66039	R.66039	R.66039.1S	R.66039.2S	R.66039.1C	R.66039.2C	
<b>S-10 (T-10) PICKUP (4WD)</b>									
89-97		F	R.66006	R.66006	R.66006.1S	R.66006.2S	R.66006.1C	R.66006.2C	
		R							
98-03		F	R.66038	R.66038	R.66038.1S	R.66038.2S	R.66038.1C	R.66038.2C	
		R	R.66036	R.66036	R.66036.1S	R.66036.2S	R.66036.1C	R.66036.2C	
04	2.2L ENG	F	R.66038	R.66038	R.66038.1S	R.66038.2S	R.66038.1C	R.66038.2C	
		R	R.66036	R.66036	R.66036.1S	R.66036.2S	R.66036.1C	R.66036.2C	
04	4.3L ENG	F	R.66038	R.66038	R.66038.1S	R.66038.2S	R.66038.1C	R.66038.2C	
		R	R.66039	R.66039	R.66039.1S	R.66039.2S	R.66039.1C	R.66039.2C	
<b>TAHOE 2WD</b>									
95-00		F	R.66025	R.66025	R.66025.1S	R.66025.2S	R.66025.1C	R.66025.2C	
		R							
00-06		F	R.66040	R.66040	R.66040.1S	R.66040.2S	R.66040.1C	R.66040.2C	
		R	R.66045	R.66045	R.66045.1S	R.66045.2S	R.66045.1C	R.66045.2C	
07		F	R.66057	R.66057	R.66057.1S	R.66057.2S	R.66057.1C	R.66057.2C	
		R	R.66065	R.66065	R.66065.1S	R.66065.2S	R.66065.1C	R.66065.2C	
<b>TAHOE 4WD</b>									
95-00	W/ REAR DRUM	F	R.66009	R.66009	R.66009.1S	R.66009.2S	R.66009.1C	R.66009.2C	
		R							
00-02	W/ REAR DISC	F	R.66040	R.66040	R.66040.1S	R.66040.2S	R.66040.1C	R.66040.2C	
	W/ LIMITED SLIP AXLE	R	R.66045	R.66045	R.66045.1S	R.66045.2S	R.66045.1C	R.66045.2C	
00-02	W/ REAR DISC	F	R.66040	R.66040	R.66040.1S	R.66040.2S	R.66040.1C	R.66040.2C	



MAKE/MODEL YEAR		AXLE F/R	BASIC OEM		SLOTTED		DRILLED & SLOTTED		NOTES
			PART #		PART #		PART #		
			LEFT	RIGHT	LEFT	RIGHT	LEFT	RIGHT	
90-93		F R	R.63017	R.63017	R.63017.1S	R.63017.2S	R.63017.1C	R.63017.2C	
<b>IMPERIAL</b>									
90-93		F R	R.63017	R.63017	R.63017.1S	R.63017.2S	R.63017.1C	R.63017.2C	
<b>INTREPID, ES (CANADA)</b>									
99-04	W/ REAR DRUM	F R	R.63034	R.63034	R.63034.1S	R.63034.2S	R.63034.1C	R.63034.2C	
99-04	W/ REAR DISC	F R	R.63034 R.63035	R.63034 R.63035	R.63034.1S R.63035.1S	R.63034.2S R.63035.2S	R.63034.1C R.63035.1C	R.63034.2C R.63035.2C	
<b>LeBARON (ALL MODEL)</b>									
90-95	W/ REAR DRUM	F R	R.63017	R.63017	R.63017.1S	R.63017.2S	R.63017.1C	R.63017.2C	
90-95	W/ REAR DISC	F R	R.63017 R.63029	R.63017 R.63029	R.63017.1S R.63029.1S	R.63017.2S R.63029.2S	R.63017.1C R.63029.1C	R.63017.2C R.63029.2C	
90-95	282MM FRONT DISC W/ REAR DISC	F R	R.63027 R.63030	R.63027 R.63030	R.63027.1S R.63030.1S	R.63027.2S R.63030.2S	R.63027.1C R.63030.1C	R.63027.2C R.63030.2C	
<b>LHS</b>									
93-97		F R	R.63034 R.63035	R.63034 R.63035	R.63034.1S R.63035.1S	R.63034.2S R.63035.2S	R.63034.1C R.63035.1C	R.63034.2C R.63035.2C	
98-00	282MM FRONT DISC	F R	R.63044 R.63035	R.63044 R.63035	R.63044.1S R.63035.1S	R.63044.2S R.63035.2S	R.63044.1C R.63035.1C	R.63044.2C R.63035.2C	
98-00	297MM FRONT DISC	F R	R.63045 R.63035	R.63045 R.63035	R.63045.1S R.63035.1S	R.63045.2S R.63035.2S	R.63045.1C R.63035.1C	R.63045.2C R.63035.2C	
01		F R	R.63045 R.63035	R.63045 R.63035	R.63045.1S R.63035.1S	R.63045.2S R.63035.2S	R.63045.1C R.63035.1C	R.63045.2C R.63035.2C	
<b>NEON (FROM 2002 SEE DODGE NEON)</b>									
00-01	W/ REAR DRUM	F R	R.63050	R.63050	R.63050.1S	R.63050.2S	R.63050.1C	R.63050.2C	
00-01	W/ REAR DISC	F R	R.63050 R.63040	R.63050 R.63040	R.63050.1S R.63040.1S	R.63050.2S R.63040.2S	R.63050.1C R.63040.1C	R.63050.2C R.63040.2C	
<b>NEW YORKER</b>									
90	W/ REAR DRUM	F R	R.63017	R.63017	R.63017.1S	R.63017.2S	R.63017.1C	R.63017.2C	
90	W/ REAR DISC	F R	R.63017 R.63028	R.63017 R.63028	R.63017.1S R.63028.1S	R.63017.2S R.63028.2S	R.63017.1C R.63028.1C	R.63017.2C R.63028.2C	
91-93	W/ REAR DRUM	F R	R.63017	R.63017	R.63017.1S	R.63017.2S	R.63017.1C	R.63017.2C	
91-93	W/ REAR DISC	F R	R.63017 R.63029	R.63017 R.63029	R.63017.1S R.63029.1S	R.63017.2S R.63029.2S	R.63017.1C R.63029.1C	R.63017.2C R.63029.2C	
94	W/ REAR DRUM	F R	R.63034	R.63034	R.63034.1S	R.63034.2S	R.63034.1C	R.63034.2C	
94	W/ REAR DISC	F R	R.63034 R.63035	R.63034 R.63035	R.63034.1S R.63035.1S	R.63034.2S R.63035.2S	R.63034.1C R.63035.1C	R.63034.2C R.63035.2C	
95-96		F R	R.63034 R.63035	R.63034 R.63035	R.63034.1S R.63035.1S	R.63034.2S R.63035.2S	R.63034.1C R.63035.1C	R.63034.2C R.63035.2C	
<b>PACIFICA</b>									
04-07		F R	R.63058 R.63057	R.63058 R.63057	R.63058.1S R.63057.1S	R.63058.2S R.63057.2S	R.63058.1C R.63057.1C	R.63058.2C R.63057.2C	
<b>PROWLER</b>									
02		F R	R.67039	R.67039	R.67039.1S	R.67039.2S	R.67039.1C	R.67039.2C	
<b>PT CRUISER</b>									
01-02	W/ REAR DRUM	F R	R.63052	R.63052	R.63052.1S	R.63052.2S	R.63052.1C	R.63052.2C	
01-02	W/ REAR DISC (EXC TURBO)	F R	R.63052 R.63040	R.63052 R.63040	R.63052.1S R.63040.1S	R.63052.2S R.63040.2S	R.63052.1C R.63040.1C	R.63052.2C R.63040.2C	
03	W/ REAR DRUM	F R	R.63052	R.63052	R.63052.1S	R.63052.2S	R.63052.1C	R.63052.2C	
03	W/ REAR DISC (EXC TURBO)	F R	R.63052 R.63040	R.63052 R.63040	R.63052.1S R.63040.1S	R.63052.2S R.63040.2S	R.63052.1C R.63040.1C	R.63052.2C R.63040.2C	
03	TURBO	F R	R.63053 R.63054	R.63053 R.63054	R.63053.1S R.63054.1S	R.63053.2S R.63054.2S	R.63053.1C R.63054.1C	R.63053.2C R.63054.2C	
04-05	W/ REAR DRUM (EXC TURBO)	F R	R.63052	R.63052	R.63052.1S	R.63052.2S	R.63052.1C	R.63052.2C	
04-05	W/ REAR DRUM TURBO (LIMITED PLATINUM)	F R	R.63053	R.63053	R.63053.1S	R.63053.2S	R.63053.1C	R.63053.2C	
04-05	W/ REAR DISC	F	R.63053	R.63053	R.63053.1S	R.63053.2S	R.63053.1C	R.63053.2C	

BRAKE DISC		BASIC OEM		SLOTTED		DRILLED & SLOTTED		NOTES	
		AXLE	PART #		PART #		PART #		
MAKE/MODEL	YEAR	F/R	LEFT	RIGHT	LEFT	RIGHT	LEFT	RIGHT	
	TURBO (LIMITED PLATINUM)	R	R.63043	R.63043	R.63043.1S	R.63043.2S	R.63043.1C	R.63043.2C	
04-05	W/ REAR DISC	F	R.63053	R.63053	R.63053.1S	R.63053.2S	R.63053.1C	R.63053.2C	
	HO TURBO (GT, SERIES 3)	R	R.63054	R.63054	R.63054.1S	R.63054.2S	R.63054.1C	R.63054.2C	
06-07	W/ REAR DRUM	F	R.63052	R.63052	R.63052.1S	R.63052.2S	R.63052.1C	R.63052.2C	
		R							
06-07	W/ REAR DISC	F	R.63052	R.63052	R.63052.1S	R.63052.2S	R.63052.1C	R.63052.2C	
	TURBO (LIMITED)	R	R.63043	R.63043	R.63043.1S	R.63043.2S	R.63043.1C	R.63043.2C	
06-07	W/ REAR DISC	F	R.63053	R.63053	R.63053.1S	R.63053.2S	R.63053.1C	R.63053.2C	
	HO TURBO (GT)	R	R.63054	R.63054	R.63054.1S	R.63054.2S	R.63054.1C	R.63054.2C	
<b>SEBRING CONVERTIBLE</b>									
96-00	W/ REAR DRUM	F	R.63041	R.63041	R.63041.1S	R.63041.2S	R.63041.1C	R.63041.2C	
		R							
96-00	W/ REAR DISC	F	R.63041	R.63041	R.63041.1S	R.63041.2S	R.63041.1C	R.63041.2C	
		R	R.63043	R.63043	R.63043.1S	R.63043.2S	R.63043.1C	R.63043.2C	
01-04		F	R.63042	R.63042	R.63042.1S	R.63042.2S			
		R	R.63043	R.63043	R.63043.1S	R.63043.2S	R.63043.1C	R.63043.2C	
05-06	W/ REAR DRUM (4 CYL.)	F	R.63042	R.63042	R.63042.1S	R.63042.2S			
		R							
05-06	W/ REAR DISC (6 CYL.)	F	R.63042	R.63042	R.63042.1S	R.63042.2S			
		R	R.63043	R.63043	R.63043.1S	R.63043.2S	R.63043.1C	R.63043.2C	
08	2.4L (W/ REAR DRUM)	F	R.63067	R.63067	R.63067.1S	R.63067.2S	R.63067.1C	R.63067.2C	C
		R							
08	TOURING (2.7L)	F	R.63067	R.63067	R.63067.1S	R.63067.2S	R.63067.1C	R.63067.2C	C
		R	R.63066	R.63066	R.63066.1S	R.63066.2S	R.63066.1C	R.63066.2C	C
08	LIMITED (3.5L)	F	R.63067	R.63067	R.63067.1S	R.63067.2S	R.63067.1C	R.63067.2C	C
		R	R.63069	R.63069	R.63069.1S	R.63069.2S	R.63069.1C	R.63069.2C	C
<b>SEBRING COUPE</b>									
95-99	W/ REAR DRUM	F	R.46042	R.46042	R.46042.1S	R.46042.2S	R.46042.1C	R.46042.2C	
		R							
95-99	W/ REAR DISC	F	R.46042	R.46042	R.46042.1S	R.46042.2S	R.46042.1C	R.46042.2C	
		R	R.46047	R.46047	R.46047.1S	R.46047.2S	R.46047.1C	R.46047.2C	
00		F	R.46042	R.46042	R.46042.1S	R.46042.2S	R.46042.1C	R.46042.2C	
		R	R.46047	R.46047	R.46047.1S	R.46047.2S	R.46047.1C	R.46047.2C	
01-05	W/ REAR DRUM (4 CYL.)	F	R.46042	R.46042	R.46042.1S	R.46042.2S	R.46042.1C	R.46042.2C	
		R							
01-05	W/ REAR DISC (6 CYL.)	F	R.46061	R.46061	R.46061.1S	R.46061.2S	R.46061.1C	R.46061.2C	
		R	R.46047	R.46047	R.46047.1S	R.46047.2S	R.46047.1C	R.46047.2C	
<b>SEBRING SEDAN</b>									
01-02		F	R.63042	R.63042	R.63042.1S	R.63042.2S			
		R	R.63043	R.63043	R.63043.1S	R.63043.2S	R.63043.1C	R.63043.2C	
03-06	W/ REAR DRUM (4 CYL.)	F	R.63042	R.63042	R.63042.1S	R.63042.2S			
		R							
03-06	W/ REAR DISC (6 CYL.)	F	R.63042	R.63042	R.63042.1S	R.63042.2S			
		R	R.63043	R.63043	R.63043.1S	R.63043.2S	R.63043.1C	R.63043.2C	
08	2.4L (W/ REAR DRUM)	F	R.63067	R.63067	R.63067.1S	R.63067.2S	R.63067.1C	R.63067.2C	C
		R							
08	2.7L (TOURING)	F	R.63067	R.63067	R.63067.1S	R.63067.2S	R.63067.1C	R.63067.2C	C
		R	R.63066	R.63066	R.63066.1S	R.63066.2S	R.63066.1C	R.63066.2C	C
08	3.5L (LIMITED)	F	R.63067	R.63067	R.63067.1S	R.63067.2S	R.63067.1C	R.63067.2C	C
		R	R.63069	R.63069	R.63069.1S	R.63069.2S	R.63069.1C	R.63069.2C	C
<b>SRT-6 (SEE CROSSFIRE)</b>									
<b>SRT-8 (SEE 300C)</b>									
<b>300, 300C</b>									
05	300, TOURING, LIMITED (2.7L, 3.5L)	F	R.63059	R.63059	R.63059.1S	R.63059.2S	R.63059.1C	R.63059.2C	
	W/ SOLID REAR DISC	R	R.63060	R.63060	R.63060.1S	R.63060.2S	R.63060.1C	R.63060.2C	
05	300C (5.7L)	F	R.63061	R.63061	R.63061.1S	R.63061.2S	R.63061.1C	R.63061.2C	
	W/ VENTED REAR DISC	R	R.63062	R.63062	R.63062.1S	R.63062.2S	R.63062.1C	R.63062.2C	
06-07	300, TOURING, LIMITED (2.7L, 3.5L), 2WD	F	R.63059	R.63059	R.63059.1S	R.63059.2S	R.63059.1C	R.63059.2C	
	W/ SOLID REAR DISC	R	R.63060	R.63060	R.63060.1S	R.63060.2S	R.63060.1C	R.63060.2C	
06-07	300, TOURING, LIMITED (3.5L), AWD	F	R.63061	R.63061	R.63061.1S	R.63061.2S	R.63061.1C	R.63061.2C	
	W/ VENTED REAR DISC	R	R.63062	R.63062	R.63062.1S	R.63062.2S	R.63062.1C	R.63062.2C	
06-07	300C (5.7L), 2WD & AWD	F	R.63061	R.63061	R.63061.1S	R.63061.2S	R.63061.1C	R.63061.2C	
	W/ VENTED REAR DISC	R	R.63062	R.63062	R.63062.1S	R.63062.2S	R.63062.1C	R.63062.2C	
06-07	SRT-8	F	R.63063	R.63063	R.63063.1S	R.63063.2S	R.63063.1C	R.63063.2C	C
		R	R.63064	R.63064	R.63064.1S	R.63064.2S	R.63064.1C	R.63064.2C	C
<b>300M</b>									
99-04	W/O PERFORMANCE PKG	F	R.63045	R.63045	R.63045.1S	R.63045.2S	R.63045.1C	R.63045.2C	
		R	R.63035	R.63035	R.63035.1S	R.63035.2S	R.63035.1C	R.63035.2C	

BRAKE DISC		BASIC OEM		SLOTTED		DRILLED & SLOTTED			
MAKE/MODEL	AXLE	PART #		PART #		PART #		NOTES	
YEAR	F/R	LEFT	RIGHT	LEFT	RIGHT	LEFT	RIGHT		
99-04	W/ PERFORMANCE PKG	F	R.63048	R.63048	R.63048.1S	R.63048.2S	R.63048.1C	R.63048.2C	
		R	R.63035	R.63035	R.63035.1S	R.63035.2S	R.63035.1C	R.63035.2C	
<b>DODGE</b>									
<b>AVENGER</b>									
95-99	W/ REAR DRUM	F	R.46042	R.46042	R.46042.1S	R.46042.2S	R.46042.1C	R.46042.2C	
		R							
95-99	W/ REAR DISC	F	R.46042	R.46042	R.46042.1S	R.46042.2S	R.46042.1C	R.46042.2C	
		R	R.46047	R.46047	R.46047.1S	R.46047.2S	R.46047.1C	R.46047.2C	
00		F	R.46042	R.46042	R.46042.1S	R.46042.2S	R.46042.1C	R.46042.2C	
		R	R.46047	R.46047	R.46047.1S	R.46047.2S	R.46047.1C	R.46047.2C	
08	SE, SXT (2.4L)	F	R.63067	R.63067	R.63067.1S	R.63067.2S	R.63067.1C	R.63067.2C	C
		R							
08	SXT (2.7L)	F	R.63067	R.63067	R.63067.1S	R.63067.2S	R.63067.1C	R.63067.2C	C
		R	R.63066	R.63066	R.63066.1S	R.63066.2S	R.63066.1C	R.63066.2C	C
08	R/T (3.5L)	F	R.63067	R.63067	R.63067.1S	R.63067.2S	R.63067.1C	R.63067.2C	C
		R	R.63069	R.63069	R.63069.1S	R.63069.2S	R.63069.1C	R.63069.2C	C
<b>CALIBER</b>									
07	SE, SXT (1.8L)	F	R.63068	R.63068	R.63068.1S	R.63068.2S	R.63068.1C	R.63068.2C	C
		R							
07	SE, SXT (2.0L)	F	R.63067	R.63067	R.63067.1S	R.63067.2S	R.63067.1C	R.63067.2C	C
		R							
07	R/T (2.4L), AWD	F	R.63067	R.63067	R.63067.1S	R.63067.2S	R.63067.1C	R.63067.2C	C
		R	R.63066	R.63066	R.63066.1S	R.63066.2S	R.63066.1C	R.63066.2C	C
<b>CHARGER</b>									
06-07	DAYTONA R/T (5.7L V8)	F	R.63061	R.63061	R.63061.1S	R.63061.2S	R.63061.1C	R.63061.2C	
	W/ VENTED REAR DISC	R	R.63065	R.63065	R.63065.1S	R.63065.2S	R.63065.1C	R.63065.2C	C
06-07	SE (3.5L V8)	F	R.63059	R.63059	R.63059.1S	R.63059.2S	R.63059.1C	R.63059.2C	
	W/ SOLID REAR DISC	R	R.63060	R.63060	R.63060.1S	R.63060.2S	R.63060.1C	R.63060.2C	
06-07	SXT (3.5L V6), R/T (5.7L V8)	F	R.63061	R.63061	R.63061.1S	R.63061.2S	R.63061.1C	R.63061.2C	
	W/ VENTED REAR DISC	R	R.63062	R.63062	R.63062.1S	R.63062.2S	R.63062.1C	R.63062.2C	
06-07	SRT-8	F	R.63063	R.63063	R.63063.1S	R.63063.2S	R.63063.1C	R.63063.2C	C
		R	R.63064	R.63064	R.63064.1S	R.63064.2S	R.63064.1C	R.63064.2C	C
<b>COLT (EXC VISTA &amp; WAGON)</b>									
93	2 DR	F	R.46044	R.46044	R.46044.1S	R.46044.2S	R.46044.1C	R.46044.2C	
		R							
93	4 DR (W/ REAR DRUM)	F	R.46043	R.46043	R.46043.1S	R.46043.2S	R.46043.1C	R.46043.2C	
		R							
93	4 DR (W/ REAR DISC)	F	R.46043	R.46043	R.46043.1S	R.46043.2S	R.46043.1C	R.46043.2C	
		R	R.46045	R.46045	R.46045.1S	R.46045.2S	R.46045.1C	R.46045.2C	
94	2 DR (SOLID FRONT DISC)	F	R.46044	R.46044	R.46044.1S	R.46044.2S	R.46044.1C	R.46044.2C	
		R							
94	2 DR (VENTED FRONT DISC)	F	R.46043	R.46043	R.46043.1S	R.46043.2S	R.46043.1C	R.46043.2C	
		R							
94	4 DR (W/ REAR DRUM)	F	R.46043	R.46043	R.46043.1S	R.46043.2S	R.46043.1C	R.46043.2C	
		R							
94	4 DR (W/ REAR DISC)	F	R.46043	R.46043	R.46043.1S	R.46043.2S	R.46043.1C	R.46043.2C	
		R	R.46045	R.46045	R.46045.1S	R.46045.2S	R.46045.1C	R.46045.2C	
<b>COLT VISTA</b>									
92-94	2WD, 4WD (WITH REAR DRUM)	F	R.46039	R.46039	R.46039.1S	R.46039.2S	R.46039.1C	R.46039.2C	
		R							
92-94	2WD, 4WD (WITH REAR DISC)	F	R.46039	R.46039	R.46039.1S	R.46039.2S	R.46039.1C	R.46039.2C	
		R	R.46038	R.46038	R.46038.1S	R.46038.2S	R.46038.1C	R.46038.2C	
<b>DAKOTA</b>									
97-02	2WD, 4WD	F	R.67038	R.67038	R.67038.1S	R.67038.2S	R.67038.1C	R.67038.2C	
		R							
03-04	2WD, 4WD (W/ REAR DRUM)	F	R.67057	R.67057	R.67057.1S	R.67057.2S	R.67057.1C	R.67057.2C	
		R							
03-04	2WD, 4WD (W/ REAR DISC)	F	R.67057	R.67057	R.67057.1S	R.67057.2S	R.67057.1C	R.67057.2C	
		R	R.67058	R.67058	R.67058.1S	R.67058.2S	R.67058.1C	R.67058.2C	
05-07	2WD, 4WD	F	R.67065	R.67065	R.67065.1S	R.67065.2S	R.67065.1C	R.67065.2C	
		R							
<b>DAYTONA</b>									
90	W/ REAR DRUM	F	R.63017	R.63017	R.63017.1S	R.63017.2S	R.63017.1C	R.63017.2C	
		R							
90	W/ REAR DISC (14" WHEEL)	F	R.63017	R.63017	R.63017.1S	R.63017.2S	R.63017.1C	R.63017.2C	
		R	R.63029	R.63029	R.63029.1S	R.63029.2S	R.63029.1C	R.63029.2C	
90	W/ REAR DISC (15" WHEEL)	F	R.63027	R.63027	R.63027.1S	R.63027.2S	R.63027.1C	R.63027.2C	

BRAKE DISC		BASIC OEM		SLOTTED		DRILLED & SLOTTED		NOTES	
MAKE/MODEL		AXLE	PART #		PART #		PART #		
YEAR		F/R	LEFT	RIGHT	LEFT	RIGHT	LEFT		RIGHT
90	W/ REAR DISC (16" WHEEL)	R	R.63029	R.63029	R.63029.1S	R.63029.2S	R.63029.1C	R.63029.2C	
		F	R.63027	R.63027	R.63027.1S	R.63027.2S	R.63027.1C	R.63027.2C	
		R	R.63030	R.63030	R.63030.1S	R.63030.2S	R.63030.1C	R.63030.2C	
91	260MM FRONT DISC	F	R.63017	R.63017	R.63017.1S	R.63017.2S	R.63017.1C	R.63017.2C	
		R							
91	282MM FRONT DISC	F	R.63027	R.63027	R.63027.1S	R.63027.2S	R.63027.1C	R.63027.2C	
	W/ REAR DRUM	R							
91	W/ REAR DISC	F	R.63027	R.63027	R.63027.1S	R.63027.2S	R.63027.1C	R.63027.2C	
		R	R.63030	R.63030	R.63030.1S	R.63030.2S	R.63030.1C	R.63030.2C	
92-93	260MM FRONT DISC	F	R.63017	R.63017	R.63017.1S	R.63017.2S	R.63017.1C	R.63017.2C	
		R							
92-93	W/ REAR DISC	F	R.63027	R.63027	R.63027.1S	R.63027.2S	R.63027.1C	R.63027.2C	
		R	R.63030	R.63030	R.63030.1S	R.63030.2S	R.63030.1C	R.63030.2C	
<b>DURANGO</b>									
98-02		F	R.67038	R.67038	R.67038.1S	R.67038.2S	R.67038.1C	R.67038.2C	
		R							
03		F	R.67059	R.67059	R.67059.1S	R.67059.2S	R.67059.1C	R.67059.2C	
		R	R.67060	R.67060	R.67060.1S	R.67060.2S	R.67060.1C	R.67060.2C	
04-07		F	R.67053	R.67053	R.67053.1S	R.67053.2S	R.67053.1C	R.67053.2C	
		R	R.67054	R.67054	R.67054.1S	R.67054.2S	R.67054.1C	R.67054.2C	
<b>DYNASTY</b>									
90	W/ REAR DRUM	F	R.63017	R.63017	R.63017.1S	R.63017.2S	R.63017.1C	R.63017.2C	
		R							
90	W/ REAR DISC	F	R.63017	R.63017	R.63017.1S	R.63017.2S	R.63017.1C	R.63017.2C	
		R	R.63028	R.63028	R.63028.1S	R.63028.2S	R.63028.1C	R.63028.2C	
91-93	W/ REAR DRUM	F	R.63017	R.63017	R.63017.1S	R.63017.2S	R.63017.1C	R.63017.2C	
		R							
91-93	W/ REAR DISC	F	R.63017	R.63017	R.63017.1S	R.63017.2S	R.63017.1C	R.63017.2C	
		R	R.63029	R.63029	R.63029.1S	R.63029.2S	R.63029.1C	R.63029.2C	
<b>INTREPID</b>									
93-94	W/ REAR DRUM	F	R.63034	R.63034	R.63034.1S	R.63034.2S	R.63034.1C	R.63034.2C	
		R							
93-94	W/ REAR DISC	F	R.63034	R.63034	R.63034.1S	R.63034.2S	R.63034.1C	R.63034.2C	
		R	R.63035	R.63035	R.63035.1S	R.63035.2S	R.63035.1C	R.63035.2C	
95-96		F	R.63034	R.63034	R.63034.1S	R.63034.2S	R.63034.1C	R.63034.2C	
		R	R.63035	R.63035	R.63035.1S	R.63035.2S	R.63035.1C	R.63035.2C	
97	W/ REAR DRUM	F	R.63034	R.63034	R.63034.1S	R.63034.2S	R.63034.1C	R.63034.2C	
		R							
97	W/ REAR DISC	F	R.63034	R.63034	R.63034.1S	R.63034.2S	R.63034.1C	R.63034.2C	
		R	R.63035	R.63035	R.63035.1S	R.63035.2S	R.63035.1C	R.63035.2C	
98-00	15" WHEEL	F	R.63044	R.63044	R.63044.1S	R.63044.2S	R.63044.1C	R.63044.2C	
		R	R.63035	R.63035	R.63035.1S	R.63035.2S	R.63035.1C	R.63035.2C	
98-00	16", 17" WHEEL	F	R.63045	R.63045	R.63045.1S	R.63045.2S	R.63045.1C	R.63045.2C	
	W/O PERFORMANCE PKG	R	R.63035	R.63035	R.63035.1S	R.63035.2S	R.63035.1C	R.63035.2C	
01-04	W/O PERFORMANCE PKG	F	R.63045	R.63045	R.63045.1S	R.63045.2S	R.63045.1C	R.63045.2C	
		R	R.63035	R.63035	R.63035.1S	R.63035.2S	R.63035.1C	R.63035.2C	
01-04	W/ PERFORMANCE PKG	F	R.63048	R.63048	R.63048.1S	R.63048.2S	R.63048.1C	R.63048.2C	
		R	R.63035	R.63035	R.63035.1S	R.63035.2S	R.63035.1C	R.63035.2C	
<b>MAGNUM</b>									
05	SE, SXT (2.7L V6, 3.5L V6)	F	R.63059	R.63059	R.63059.1S	R.63059.2S	R.63059.1C	R.63059.2C	
	W/ SOLID REAR DISC	R	R.63060	R.63060	R.63060.1S	R.63060.2S	R.63060.1C	R.63060.2C	
05	RT (5.7L V8)	F	R.63061	R.63061	R.63061.1S	R.63061.2S	R.63061.1C	R.63061.2C	
	W/ VENTED REAR DISC	R	R.63062	R.63062	R.63062.1S	R.63062.2S	R.63062.1C	R.63062.2C	
06-07	SE, SXT (2.7L V6, 3.5L V6) 2WD	F	R.63059	R.63059	R.63059.1S	R.63059.2S	R.63059.1C	R.63059.2C	
	W/ SOLID REAR DISC	R	R.63060	R.63060	R.63060.1S	R.63060.2S	R.63060.1C	R.63060.2C	
06-07	SXT (3.5L V6) AWD, R/T (5.7L V8) 2WD, AWD	F	R.63061	R.63061	R.63061.1S	R.63061.2S	R.63061.1C	R.63061.2C	
	W/ VENTED REAR DISC	R	R.63062	R.63062	R.63062.1S	R.63062.2S	R.63062.1C	R.63062.2C	
06-07	SRT-8	F	R.63063	R.63063	R.63063.1S	R.63063.2S	R.63063.1C	R.63063.2C	C
		R	R.63064	R.63064	R.63064.1S	R.63064.2S	R.63064.1C	R.63064.2C	C
<b>NEON</b>									
94-95	W/ REAR DRUM (4 LUG)	F	R.63038	R.63038	R.63038.1S	R.63038.2S	R.63038.1C	R.63038.2C	
		R							
94-95	W/ REAR DRUM (5 LUG)	F	R.63039	R.63039	R.63039.1S	R.63039.2S	R.63039.1C	R.63039.2C	
		R							
96	W/ REAR DRUM (4 LUG)	F	R.63038	R.63038	R.63038.1S	R.63038.2S	R.63038.1C	R.63038.2C	
		R							
96	W/ REAR DRUM (5 LUG)	F	R.63039	R.63039	R.63039.1S	R.63039.2S	R.63039.1C	R.63039.2C	
		R							



BRAKE DISC		BASIC OEM		SLOTTED		DRILLED & SLOTTED		NOTES	
		AXLE	PART #		PART #		PART #		
MAKE/MODEL	YEAR	F/R	LEFT	RIGHT	LEFT	RIGHT	LEFT	RIGHT	
96	W/ REAR DISC	F	R.63039	R.63039	R.63039.1S	R.63039.2S	R.63039.1C	R.63039.2C	
		R	R.63040	R.63040	R.63040.1S	R.63040.2S	R.63040.1C	R.63040.2C	
97-99	W/ REAR DRUM	F	R.63039	R.63039	R.63039.1S	R.63039.2S	R.63039.1C	R.63039.2C	
		R							
97-99	W/ REAR DISC	F	R.63039	R.63039	R.63039.1S	R.63039.2S	R.63039.1C	R.63039.2C	
		R	R.63040	R.63040	R.63040.1S	R.63040.2S	R.63040.1C	R.63040.2C	
00-03	W/ REAR DRUM	F	R.63050	R.63050	R.63050.1S	R.63050.2S	R.63050.1C	R.63050.2C	
		R							
00-03	W/ REAR DISC	F	R.63050	R.63050	R.63050.1S	R.63050.2S	R.63050.1C	R.63050.2C	
		R	R.63040	R.63040	R.63040.1S	R.63040.2S	R.63040.1C	R.63040.2C	
04-05	W/ REAR DRUM	F	R.63050	R.63050	R.63050.1S	R.63050.2S	R.63050.1C	R.63050.2C	
		R							
04-05	W/ REAR DISC	F	R.63050	R.63050	R.63050.1S	R.63050.2S	R.63050.1C	R.63050.2C	
		R	R.63043	R.63043	R.63043.1S	R.63043.2S	R.63043.1C	R.63043.2C	
<b>NITRO</b>									
07		F	R.63071	R.63071	R.63071.1S	R.63071.2S	R.63071.1C	R.63071.2C	c
		R	R.63070	R.63070	R.63070.1S	R.63070.2S	R.63070.1C	R.63070.2C	c
<b>RAM 1500 PICKUP (2WD)</b>									
94-99		F	R.67028	R.67028	R.67028.1S	R.67028.2S	R.67028.1C	R.67028.2C	
		R							
00-01		F	R.67048	R.67048	R.67048.1S	R.67048.2S	R.67048.1C	R.67048.2C	
		R							
02-05		F	R.67053	R.67053	R.67053.1S	R.67053.2S	R.67053.1C	R.67053.2C	
		R	R.67054	R.67054	R.67054.1S	R.67054.2S	R.67054.1C	R.67054.2C	
06-07	REG CAB & QUAD CAB	F	R.67053	R.67053	R.67053.1S	R.67053.2S	R.67053.1C	R.67053.2C	
		R	R.67054	R.67054	R.67054.1S	R.67054.2S	R.67054.1C	R.67054.2C	
06-07	MEGA CAB	F	R.67061	R.67061	R.67061.1S	R.67061.2S	R.67061.1C	R.67061.2C	
		R	R.67062	R.67062	R.67062.1S	R.67062.2S	R.67062.1C	R.67062.2C	
<b>RAM 1500 PICKUP (4WD)</b>									
94-99		F	R.67029	R.67029	R.67029.1S	R.67029.2S	R.67029.1C	R.67029.2C	
		R							
00-01		F	R.67050	R.67050	R.67050.1S	R.67050.2S	R.67050.1C	R.67050.2C	
		R							
02-05		F	R.67053	R.67053	R.67053.1S	R.67053.2S	R.67053.1C	R.67053.2C	
		R	R.67054	R.67054	R.67054.1S	R.67054.2S	R.67054.1C	R.67054.2C	
06-07	REG CAB & QUAD CAB	F	R.67053	R.67053	R.67053.1S	R.67053.2S	R.67053.1C	R.67053.2C	
		R	R.67054	R.67054	R.67054.1S	R.67054.2S	R.67054.1C	R.67054.2C	
06-07	MEGA CAB	F	R.67061	R.67061	R.67061.1S	R.67061.2S	R.67061.1C	R.67061.2C	
		R	R.67062	R.67062	R.67062.1S	R.67062.2S	R.67062.1C	R.67062.2C	
<b>RAM 2500 PICKUP (2WD)</b>									
94-99		F	R.67030	R.67030	R.67030.1S	R.67030.2S	R.67030.1C	R.67030.2C	
		R							
00-7/4/00		F	R.67046	R.67046	R.67046.1S	R.67046.2S	R.67046.1C	R.67046.2C	
		R							
7/5/00-02	W/ REAR DISC	F	R.67046	R.67046	R.67046.1S	R.67046.2S	R.67046.1C	R.67046.2C	
		R	R.67051	R.67051	R.67051.1S	R.67051.2S	R.67051.1C	R.67051.2C	
03-07		F	R.67061	R.67061	R.67061.1S	R.67061.2S	R.67061.1C	R.67061.2C	
		R	R.67062	R.67062	R.67062.1S	R.67062.2S	R.67062.1C	R.67062.2C	
<b>RAM 2500 PICKUP (4WD)</b>									
94-96	3500 LBS. FRONT AXLE 7500 LBS. GVW	F	R.62042	R.62042	R.62042.1S	R.62042.2S	R.62042.1C	R.62042.2C	
		R							
94-96	4500 LBS. FRONT AXLE 8800 LBS. GVW	F	R.66026	R.66026	R.66026.1S	R.66026.2S	R.66026.1C	R.66026.2C	
		R							
97	7500 LBS. GVW	F	R.62042	R.62042	R.62042.1S	R.62042.2S	R.62042.1C	R.62042.2C	
		R							
97	8800 LBS. GVW	F	R.66026	R.66026	R.66026.1S	R.66026.2S	R.66026.1C	R.66026.2C	
		R							
98-99		F	R.66026	R.66026	R.66026.1S	R.66026.2S	R.66026.1C	R.66026.2C	
		R							
00-7/00		F	R.67046	R.67046	R.67046.1S	R.67046.2S	R.67046.1C	R.67046.2C	
		R							
7/5/00-02		F	R.67046	R.67046	R.67046.1S	R.67046.2S	R.67046.1C	R.67046.2C	
		R	R.67051	R.67051	R.67051.1S	R.67051.2S	R.67051.1C	R.67051.2C	
03-07		F	R.67061	R.67061	R.67061.1S	R.67061.2S	R.67061.1C	R.67061.2C	
		R	R.67062	R.67062	R.67062.1S	R.67062.2S	R.67062.1C	R.67062.2C	
<b>RAM 3500 PICKUP (2WD &amp; 4WD)</b>									
94-99	W/ SOLID REAR AXLE	F	R.66026	R.66026	R.66026.1S	R.66026.2S	R.66026.1C	R.66026.2C	
		R							

MAKE/MODEL		AXLE	BASIC OEM		SLOTTED		DRILLED & SLOTTED		NOTES
			PART #		PART #		PART #		
YEAR		F/R	LEFT	RIGHT	LEFT	RIGHT	LEFT	RIGHT	
00-7/4/00		F R	R.67046	R.67046	R.67046.1S	R.67046.2S	R.67046.1C	R.67046.2C	
7/5/00-02		F R	R.67046 R.67051	R.67046 R.67051	R.67046.1S R.67051.1S	R.67046.2S R.67051.2S	R.67046.1C R.67051.1C	R.67046.2C R.67051.2C	
03-07		F R	R.67061 R.67062	R.67061 R.67062	R.67061.1S R.67062.1S	R.67061.2S R.67062.2S	R.67061.1C R.67062.1C	R.67061.2C R.67062.2C	
<b>RAM SRT-10</b>									
04-06		F R	R.67064 R.67066	R.67064 R.67066	R.67064.1S R.67066.1S	R.67064.2S R.67066.2S	R.67064.1C R.67066.1C	R.67064.2C R.67066.2C	C C
<b>SHADOW</b>									
90-94	W/ REAR DRUM	F R	R.63017	R.63017	R.63017.1S	R.63017.2S	R.63017.1C	R.63017.2C	
90-94	W/ REAR DISC	F R	R.63017 R.63029	R.63017 R.63029	R.63017.1S R.63029.1S	R.63017.2S R.63029.2S	R.63017.1C R.63029.1C	R.63017.2C R.63029.2C	
<b>SPIRIT</b>									
90	W/ REAR DRUM	F R	R.63017	R.63017	R.63017.1S	R.63017.2S	R.63017.1C	R.63017.2C	
90	W/ REAR DISC	F R	R.63017 R.63029	R.63017 R.63029	R.63017.1S R.63029.1S	R.63017.2S R.63029.2S	R.63017.1C R.63029.1C	R.63017.2C R.63029.2C	
91-95	W/ REAR DRUM	F R	R.63017	R.63017	R.63017.1S	R.63017.2S	R.63017.1C	R.63017.2C	
91-95	260MM FRONT DISC	F R	R.63017 R.63029	R.63017 R.63029	R.63017.1S R.63029.1S	R.63017.2S R.63029.2S	R.63017.1C R.63029.1C	R.63017.2C R.63029.2C	
91-95	282MM FRONT DISC	F R	R.63027 R.63030	R.63027 R.63030	R.63027.1S R.63030.1S	R.63027.2S R.63030.2S	R.63027.1C R.63030.1C	R.63027.2C R.63030.2C	
<b>SRT-4</b>									
03-05		F R	R.63053 R.63054	R.63053 R.63054	R.63053.1S R.63054.1S	R.63053.2S R.63054.2S	R.63053.1C R.63054.1C	R.63053.2C R.63054.2C	
<b>SRT-8 (SEE CHARGER, MAGNUM)</b>									
<b>SRT-8 (SEE VIPER)</b>									
<b>STEALTH</b>									
91-93	2WD	F R	R.46032 R.46033	R.46032 R.46033	R.46032.1S R.46033.1S	R.46032.2S R.46033.2S	R.46032.1C R.46033.1C	R.46032.2C R.46033.2C	
91-93	AWD	F R	R.46031 R.46034	R.46031 R.46034	R.46031.1S R.46034.1S	R.46031.2S R.46034.2S	R.46031.1C R.46034.1C	R.46031.2C R.46034.2C	
94-96	2WD	F R	R.46032 R.46033	R.46032 R.46033	R.46032.1S R.46033.1S	R.46032.2S R.46033.2S	R.46032.1C R.46033.1C	R.46032.2C R.46033.2C	
94-96	AWD	F R	R.46052 R.46053	R.46052 R.46053	R.46052.1S R.46053.1S	R.46052.2S R.46053.2S	R.46052.1C R.46053.1C	R.46052.2C R.46053.2C	
<b>STRATUS COUPE</b>									
01-05	4 CYL.	F R	R.46042	R.46042	R.46042.1S	R.46042.2S	R.46042.1C	R.46042.2C	
01-05	6 CYL.	F R	R.46061 R.46047	R.46061 R.46047	R.46061.1S R.46047.1S	R.46061.2S R.46047.2S	R.46061.1C R.46047.1C	R.46061.2C R.46047.2C	
<b>STRATUS SEDAN</b>									
95-00	W/ REAR DRUM (14" WHEEL)	F R	R.63041	R.63041	R.63041.1S	R.63041.2S	R.63041.1C	R.63041.2C	
95-00	W/ REAR DRUM (15" WHEEL)	F R	R.63042	R.63042	R.63042.1S	R.63042.2S			
95-00	W/ REAR DISC (14" WHEEL)	F R	R.63041 R.63043	R.63041 R.63043	R.63041.1S R.63043.1S	R.63041.2S R.63043.2S	R.63041.1C R.63043.1C	R.63041.2C R.63043.2C	
95-00	W/ REAR DISC (15" WHEEL)	F R	R.63042 R.63043	R.63042 R.63043	R.63042.1S R.63043.1S	R.63042.2S R.63043.2S	R.63043.1C	R.63043.2C	
01-02		F R	R.63042 R.63043	R.63042 R.63043	R.63042.1S R.63043.1S	R.63042.2S R.63043.2S	R.63043.1C	R.63043.2C	
03-06	W/ REAR DRUM (4 CYL.)	F R	R.63042	R.63042	R.63042.1S	R.63042.2S			
03-06	W/ REAR DISC (6 CYL.)	F R	R.63042 R.63043	R.63042 R.63043	R.63042.1S R.63043.1S	R.63042.2S R.63043.2S	R.63043.1C	R.63043.2C	
<b>VIPER</b>									
92-02		F R	R.63036 R.63037	R.63036 R.63037	R.63036.1S R.63037.1S	R.63036.2S R.63037.2S	R.63036.1C R.63037.1C	R.63036.2C R.63037.2C	
03-06	SRT-10	F R	R.63055 R.63056	R.63055 R.63056	R.63055.1S R.63056.1S	R.63055.2S R.63056.2S	R.63055.1C R.63056.1C	R.63055.2C R.63056.2C	
08	SRT-10	F R	R.63055 R.63056	R.63055 R.63056	R.63055.1S R.63056.1S	R.63055.2S R.63056.2S	R.63055.1C R.63056.1C	R.63055.2C R.63056.2C	
<b>EAGLE</b>									

BRAKE DISC		BASIC OEM		SLOTTED		DRILLED & SLOTTED		NOTES	
MAKE/MODEL		AXLE	PART #		PART #		PART #		NOTES
YEAR		F/R	LEFT	RIGHT	LEFT	RIGHT	LEFT	RIGHT	
<b>TALON (EXC TURBO)</b>									
90-94		F	R.46042	R.46042	R.46042.1S	R.46042.2S	R.46042.1C	R.46042.2C	
		R	R.46028	R.46028	R.46028.1S	R.46028.2S	R.46028.1C	R.46028.2C	
95-96		F	R.46042	R.46042	R.46042.1S	R.46042.2S	R.46042.1C	R.46042.2C	
		R	R.46047	R.46047	R.46047.1S	R.46047.2S	R.46047.1C	R.46047.2C	
97-99		F	R.46042	R.46042	R.46042.1S	R.46042.2S	R.46042.1C	R.46042.2C	
		R							
<b>TALON (TSi TURBO)</b>									
90-92	2WD, 4WD	F	R.46042	R.46042	R.46042.1S	R.46042.2S	R.46042.1C	R.46042.2C	
		R	R.46028	R.46028	R.46028.1S	R.46028.2S	R.46028.1C	R.46028.2C	
93	2WD	F	R.46042	R.46042	R.46042.1S	R.46042.2S	R.46042.1C	R.46042.2C	
		R	R.46028	R.46028	R.46028.1S	R.46028.2S	R.46028.1C	R.46028.2C	
93	4WD	F	R.46032	R.46032	R.46032.1S	R.46032.2S	R.46032.1C	R.46032.2C	
		R	R.46028	R.46028	R.46028.1S	R.46028.2S	R.46028.1C	R.46028.2C	
94	2WD	F	R.46042	R.46042	R.46042.1S	R.46042.2S	R.46042.1C	R.46042.2C	
		R	R.46028	R.46028	R.46028.1S	R.46028.2S	R.46028.1C	R.46028.2C	
94	4WD	F	R.46032	R.46032	R.46032.1S	R.46032.2S	R.46032.1C	R.46032.2C	
		R	R.46048	R.46048	R.46048.1S	R.46048.2S	R.46048.1C	R.46048.2C	
94-11/94	2WD (FJ MODEL)	F	R.46042	R.46042	R.46042.1S	R.46042.2S	R.46042.1C	R.46042.2C	
		R	R.46047	R.46047	R.46047.1S	R.46047.2S	R.46047.1C	R.46047.2C	
94-11/94	4WD (FJ MODEL) W/ VENTED REAR DISC	F	R.46032	R.46032	R.46032.1S	R.46032.2S	R.46032.1C	R.46032.2C	
		R	R.46048	R.46048	R.46048.1S	R.46048.2S	R.46048.1C	R.46048.2C	
12/94-97	2WD (FJ MODEL)	F	R.46042	R.46042	R.46042.1S	R.46042.2S	R.46042.1C	R.46042.2C	
		R	R.46047	R.46047	R.46047.1S	R.46047.2S	R.46047.1C	R.46047.2C	
12/94-97	4WD (FJ MODEL) W/ SOLID REAR DISC	F	R.46032	R.46032	R.46032.1S	R.46032.2S	R.46032.1C	R.46032.2C	
		R	R.46047	R.46047	R.46047.1S	R.46047.2S	R.46047.1C	R.46047.2C	
98-99	2WD	F	R.46042	R.46042	R.46042.1S	R.46042.2S	R.46042.1C	R.46042.2C	
		R	R.46047	R.46047	R.46047.1S	R.46047.2S	R.46047.1C	R.46047.2C	
98-99	4WD	F	R.46057	R.46057	R.46057.1S	R.46057.2S	R.46057.1C	R.46057.2C	
		R	R.46047	R.46047	R.46047.1S	R.46047.2S	R.46047.1C	R.46047.2C	
<b>FORD</b>									
<b>BRONCO</b>									
5/88-93		F	R.65013	R.65013	R.65013.1S	R.65013.2S	R.65013.1C	R.65013.2C	
		R							
94-96		F	R.65041	R.65041	R.65041.1S	R.65041.2S	R.65041.1C	R.65041.2C	
		R							
<b>CONTOUR</b>									
95-97	W/ REAR DRUM	F	R.61048	R.61048	R.61048.1S	R.61048.2S	R.61048.1C	R.61048.2C	
		R							
95-97	W/ REAR DISC	F	R.61048	R.61048	R.61048.1S	R.61048.2S	R.61048.1C	R.61048.2C	
		R	R.61050	R.61050	R.61050.1S	R.61050.2S	R.61050.1C	R.61050.2C	
98-00	W/ REAR DRUM	F	R.61048	R.61048	R.61048.1S	R.61048.2S	R.61048.1C	R.61048.2C	
		R							
98-00	W/ REAR DISC	F	R.61056	R.61056	R.61056.1S	R.61056.2S	R.61056.1C	R.61056.2C	
		R	R.61050	R.61050	R.61050.1S	R.61050.2S	R.61050.1C	R.61050.2C	
<b>CROWN VICTORIA</b>									
98-02		F	R.61055	R.61055	R.61055.1S	R.61055.2S	R.61055.1C	R.61055.2C	
		R	R.61052	R.61052	R.61052.1S	R.61052.2S	R.61052.1C	R.61052.2C	
03-06		F	R.61072	R.61072	R.61072.1S	R.61072.2S	R.61072.1C	R.61072.2C	
		R	R.61073	R.61073	R.61073.1S	R.61073.2S	R.61073.1C	R.61073.2C	
<b>EDGE</b>									
07	2WD	F	R.61092	R.61092	R.61092.1S	R.61092.2S	R.61092.1C	R.61092.2C	
		R	R.61091	R.61091	R.61091.1S	R.61091.2S	R.61091.1C	R.61091.2C	
07	4WD	F	R.61090	R.61090	R.61090.1S	R.61090.2S	R.61090.1C	R.61090.2C	
		R	R.61091	R.61091	R.61091.1S	R.61091.2S	R.61091.1C	R.61091.2C	
<b>ESCAPE</b>									
01-04		F	R.65089	R.65089	R.65089.1S	R.65089.2S	R.65089.1C	R.65089.2C	
		R							
05-08	W/ REAR DRUM	F	R.65089	R.65089	R.65089.1S	R.65089.2S	R.65089.1C	R.65089.2C	
		R							
05-08	W/ REAR DISC	F	R.65107	R.65107	R.65107.1S	R.65107.2S	R.65107.1C	R.65107.2C	
		R	R.65108	R.65108	R.65108.1S	R.65108.2S	R.65108.1C	R.65108.2C	
<b>ESCORT, ZX2</b>									
91-92	DOHC 1.8L	F	R.45040	R.45040	R.45040.1S	R.45040.2S	R.45040.1C	R.45040.2C	
		R	R.45041	R.45041	R.45041.1S	R.45041.2S	R.45041.1C	R.45041.2C	
91-92	SOHC 1.9L (CALIPER CAST#22-13)	F	R.45039	R.45039	R.45039.1S	R.45039.2S	R.45039.1C	R.45039.2C	
		R							

BRAKE DISC		BASIC OEM		SLOTTED		DRILLED & SLOTTED		NOTES	
MAKE/MODEL		AXLE	PART #		PART #		PART #		
YEAR		F/R	LEFT	RIGHT	LEFT	RIGHT	LEFT		RIGHT
93-96	DOHC 1.8L	F	R.45040	R.45040	R.45040.1S	R.45040.2S	R.45040.1C	R.45040.2C	
		R	R.45041	R.45041	R.45041.1S	R.45041.2S	R.45041.1C	R.45041.2C	
93-96	SOHC 1.9L (CALIPER CAST#22-13)	F	R.45039	R.45039	R.45039.1S	R.45039.2S	R.45039.1C	R.45039.2C	
		R							
93-96	SOHC 1.9L (CALIPER CAST#22-14)	F	R.45040	R.45040	R.45040.1S	R.45040.2S	R.45040.1C	R.45040.2C	
		R	R.45041	R.45041	R.45041.1S	R.45041.2S	R.45041.1C	R.45041.2C	
97-03	W/ REAR DRUM	F	R.45040	R.45040	R.45040.1S	R.45040.2S	R.45040.1C	R.45040.2C	
		R							
97-03	W/ REAR DISC	F	R.45040	R.45040	R.45040.1S	R.45040.2S	R.45040.1C	R.45040.2C	
		R	R.45041	R.45041	R.45041.1S	R.45041.2S	R.45041.1C	R.45041.2C	
<b>EXCURSION</b>									
99-02	2WD	F	R.65073	R.65073	R.65073.1S	R.65073.2S	R.65073.1C	R.65073.2C	
		R	R.65071	R.65071	R.65071.1S	R.65071.2S	R.65071.1C	R.65071.2C	
99-02	4WD	F	R.65086	R.65086	R.65086.1S	R.65086.2S	R.65086.1C	R.65086.2C	
		R	R.65071	R.65071	R.65071.1S	R.65071.2S	R.65071.1C	R.65071.2C	
03-05	2WD	F	R.65104	R.65104	R.65104.1S	R.65104.2S	R.65104.1C	R.65104.2C	
		R	R.65071	R.65071	R.65071.1S	R.65071.2S	R.65071.1C	R.65071.2C	
03-05	4WD	F	R.65086	R.65086	R.65086.1S	R.65086.2S	R.65086.1C	R.65086.2C	
		R	R.65071	R.65071	R.65071.1S	R.65071.2S	R.65071.1C	R.65071.2C	
<b>EXPEDITION</b>									
97-11/29/99	2WD	F	R.65063	R.65063	R.65063.1S	R.65063.2S	R.65063.1C	R.65063.2C	
		R	R.65059	R.65059	R.65059.1S	R.65059.2S	R.65059.1C	R.65059.2C	
97-11/29/99	4WD	F	R.65058	R.65058	R.65058.1S	R.65058.2S	R.65058.1C	R.65058.2C	
		R	R.65059	R.65059	R.65059.1S	R.65059.2S	R.65059.1C	R.65059.2C	
11/30/99-3/18/02	2WD	F	R.65081	R.65081	R.65081.1S	R.65081.2S	R.65081.1C	R.65081.2C	
		R	R.65085	R.65085	R.65085.1S	R.65085.2S	R.65085.1C	R.65085.2C	
11/30/99-3/18/02	4WD	F	R.65088	R.65088	R.65088.1S	R.65088.2S	R.65088.1C	R.65088.2C	
		R	R.65085	R.65085	R.65085.1S	R.65085.2S	R.65085.1C	R.65085.2C	
3/19/02-06		F	R.65097	R.65097	R.65097.1S	R.65097.2S	R.65097.1C	R.65097.2C	
		R	R.65095	R.65095	R.65095.1S	R.65095.2S	R.65095.1C	R.65095.2C	
07		F	R.65119	R.65119	R.65119.1S	R.65119.2S	R.65119.1C	R.65119.2C	c
		R	R.65120	R.65120	R.65120.1S	R.65120.2S	R.65120.1C	R.65120.2C	c
<b>EXPLORER (EXC SPORT, SPORT TRAC)</b>									
93-94	2WD	F	R.65036	R.65036	R.65036.1S	R.65036.2S	R.65036.1C	R.65036.2C	
		R							
93-94	4WD	F	R.65035	R.65035	R.65035.1S	R.65035.2S	R.65035.1C	R.65035.2C	
		R							
95-01	2WD	F	R.65051	R.65051	R.65051.1S	R.65051.2S	R.65051.1C	R.65051.2C	
		R	R.65052	R.65052	R.65052.1S	R.65052.2S	R.65052.1C	R.65052.2C	
95-01	4WD	F	R.65054	R.65054	R.65054.1S	R.65054.2S	R.65054.1C	R.65054.2C	
		R	R.65052	R.65052	R.65052.1S	R.65052.2S	R.65052.1C	R.65052.2C	
02-05		F	R.65091	R.65091	R.65091.1S	R.65091.2S	R.65091.1C	R.65091.2C	
		R	R.65090	R.65090	R.65090.1S	R.65090.2S	R.65090.1C	R.65090.2C	
06-07		F	R.65118	R.65118	R.65118.1S	R.65118.2S	R.65118.1C	R.65118.2C	
		R	R.65090	R.65090	R.65090.1S	R.65090.2S	R.65090.1C	R.65090.2C	
<b>EXPLORER (SPORT, SPORT TRAC)</b>									
01-02	SPORT (2WD)	F	R.65083	R.65083	R.65083.1S	R.65083.2S	R.65083.1C	R.65083.2C	
		R	R.65052	R.65052	R.65052.1S	R.65052.2S	R.65052.1C	R.65052.2C	
01-02	SPORT (4WD)	F	R.65082	R.65082	R.65082.1S	R.65082.2S	R.65082.1C	R.65082.2C	
		R	R.65052	R.65052	R.65052.1S	R.65052.2S	R.65052.1C	R.65052.2C	
01-02	SPORT TRAC (2WD)	F	R.65083	R.65083	R.65083.1S	R.65083.2S	R.65083.1C	R.65083.2C	
		R							
01-02	SPORT SPORT (4WD)	F	R.65082	R.65082	R.65082.1S	R.65082.2S	R.65082.1C	R.65082.2C	
		R							
03-05	2WD	F	R.65083	R.65083	R.65083.1S	R.65083.2S	R.65083.1C	R.65083.2C	
		R	R.65096	R.65096	R.65096.1S	R.65096.2S	R.65096.1C	R.65096.2C	
03-05	4WD	F	R.65082	R.65082	R.65082.1S	R.65082.2S	R.65082.1C	R.65082.2C	
		R	R.65096	R.65096	R.65096.1S	R.65096.2S	R.65096.1C	R.65096.2C	
07		F	R.65118	R.65118	R.65118.1S	R.65118.2S	R.65118.1C	R.65118.2C	
		R	R.65090	R.65090	R.65090.1S	R.65090.2S	R.65090.1C	R.65090.2C	
<b>E150 (1/2 TON) VAN &amp; WAGON</b>									
90-93		F	R.65001	R.65001	R.65001.1S	R.65001.2S	R.65001.1C	R.65001.2C	
		R							
94-01	W/ 4 WHEEL ABS	F	R.65040	R.65040	R.65040.1S	R.65040.2S	R.65040.1C	R.65040.2C	
		R							
94-01	W/ REAR WHEEL ABS	F	R.65039	R.65039	R.65039.1S	R.65039.2S	R.65039.1C	R.65039.2C	
		R							
02-03		F	R.65040	R.65040	R.65040.1S	R.65040.2S	R.65040.1C	R.65040.2C	

MAKE/MODEL YEAR		AXLE F/R	BASIC OEM		SLOTTED		DRILLED & SLOTTED		NOTES
			PART #		PART #		PART #		
			LEFT	RIGHT	LEFT	RIGHT	LEFT	RIGHT	
		R							
<b>E250 (3/4 TON) VAN</b>									
89-91		F	R.65026	R.65026	R.65026.1S	R.65026.2S	R.65026.1C	R.65026.2C	
		R							
92-93		F	R.65037	R.65037	R.65037.1S	R.65037.2S	R.65037.1C	R.65037.2C	
		R							
94	W/ REAR WHEEL ABS	F	R.65037	R.65037	R.65037.1S	R.65037.2S	R.65037.1C	R.65037.2C	
		R							
95-10/00	W/ 4 WHEEL ABS	F	R.65046	R.65046	R.65046.1S	R.65046.2S	R.65046.1C	R.65046.2C	
		R							
95-10/00	W/ REAR WHEEL ABS	F	R.65045	R.65045	R.65045.1S	R.65045.2S	R.65045.1C	R.65045.2C	
		R							
11/00-03	W/ REAR DRUM	F	R.65046	R.65046	R.65046.1S	R.65046.2S	R.65046.1C	R.65046.2C	
		R							
11/00-03	W/ REAR DISC	F	R.65046	R.65046	R.65046.1S	R.65046.2S	R.65046.1C	R.65046.2C	
		R	R.65078	R.65078	R.65078.1S	R.65078.2S	R.65078.1C	R.65078.2C	
04-07		F	R.65046	R.65046	R.65046.1S	R.65046.2S	R.65046.1C	R.65046.2C	
		R	R.65078	R.65078	R.65078.1S	R.65078.2S	R.65078.1C	R.65078.2C	
<b>E350 (1 TON) VAN &amp; WAGON</b>									
89-91	SRW	F	R.65026	R.65026	R.65026.1S	R.65026.2S	R.65026.1C	R.65026.2C	
		R							
89-91	DRW	F	R.65006	R.65006	R.65006.1S	R.65006.2S	R.65006.1C	R.65006.2C	
		R							
92-93	SRW	F	R.65037	R.65037	R.65037.1S	R.65037.2S	R.65037.1C	R.65037.2C	
		R							
92-93	DRW	F	R.65006	R.65006	R.65006.1S	R.65006.2S	R.65006.1C	R.65006.2C	
		R							
94	SRW (W/ REAR WHEEL ABS)	F	R.65037	R.65037	R.65037.1S	R.65037.2S	R.65037.1C	R.65037.2C	
		R							
94	DRW	F	R.65006	R.65006	R.65006.1S	R.65006.2S	R.65006.1C	R.65006.2C	
		R							
95-98	SRW (W/ 4 WHEEL ABS)	F	R.65046	R.65046	R.65046.1S	R.65046.2S	R.65046.1C	R.65046.2C	
		R							
95-98	SRW (W/ REAR WHEEL ABS)	F	R.65045	R.65045	R.65045.1S	R.65045.2S	R.65045.1C	R.65045.2C	
		R							
95-98	DRW (W/ 4 WHEEL ABS)	F	R.65042	R.65042	R.65042.1S	R.65042.2S	R.65042.1C	R.65042.2C	
		R							
99-07	SRW (W/ 4 WHEEL ABS)	F	R.65046	R.65046	R.65046.1S	R.65046.2S	R.65046.1C	R.65046.2C	
		R	R.65078	R.65078	R.65078.1S	R.65078.2S	R.65078.1C	R.65078.2C	
99-07	SRW (W/ REAR WHEEL ABS)	F	R.65045	R.65045	R.65045.1S	R.65045.2S	R.65045.1C	R.65045.2C	
		R	R.65078	R.65078	R.65078.1S	R.65078.2S	R.65078.1C	R.65078.2C	
99-07	DRW (W/ 4 WHEEL ABS)	F	R.65042	R.65042	R.65042.1S	R.65042.2S	R.65042.1C	R.65042.2C	
		R	R.65079	R.65079	R.65079.1S	R.65079.2S	R.65079.1C	R.65079.2C	
<b>E450, 47 (1 TON) SUPER DUTY</b>									
96-01	W/ 4 WHEEL ABS	F	R.65042	R.65042	R.65042.1S	R.65042.2S	R.65042.1C	R.65042.2C	
		R	R.65064	R.65064	R.65064.1S	R.65064.2S	R.65064.1C	R.65064.2C	
02-07		F	R.65042	R.65042	R.65042.1S	R.65042.2S	R.65042.1C	R.65042.2C	
		R	R.65064	R.65064	R.65064.1S	R.65064.2S	R.65064.1C	R.65064.2C	
<b>E550</b>									
02-05		F	R.65087	R.65087	R.65087.1S	R.65087.2S	R.65087.1C	R.65087.2C	
		R	R.65092	R.65092	R.65092.1S	R.65092.2S	R.65092.1C	R.65092.2C	
<b>F150 (1/2 TON) PICKUP 2WD</b>									
73-79		F	R.65001	R.65001	R.65001.1S	R.65001.2S	R.65001.1C	R.65001.2C	
		R							
80-83	W/ 10" REAR DRUM	F	R.65011	R.65011	R.65011.1S	R.65011.2S	R.65011.1C	R.65011.2C	
		R							
80-83	W/ 11" REAR DRUM	F	R.65001	R.65001	R.65001.1S	R.65001.2S	R.65001.1C	R.65001.2C	
		R							
84-93		F	R.65001	R.65001	R.65001.1S	R.65001.2S	R.65001.1C	R.65001.2C	
		R							
94-96	W/ 4 WHEEL ABS	F	R.65040	R.65040	R.65040.1S	R.65040.2S	R.65040.1C	R.65040.2C	
		R							
94-96	W/ REAR WHEEL ABS	F	R.65039	R.65039	R.65039.1S	R.65039.2S	R.65039.1C	R.65039.2C	
		R							
97-12/1/98	W/ REAR WHEEL ABS	F	R.65056	R.65056	R.65056.1S	R.65056.2S	R.65056.1C	R.65056.2C	
		R							
97-12/1/98	W/ 4 WHEEL ABS	F	R.65055	R.65055	R.65055.1S	R.65055.2S	R.65055.1C	R.65055.2C	
		R							

BRAKE DISC		BASIC OEM			SLOTTED		DRILLED & SLOTTED		NOTES
		AXLE	PART #		PART #		PART #		
MAKE/MODEL	YEAR	F/R	LEFT	RIGHT	LEFT	RIGHT	LEFT	RIGHT	
97-12/1/98	W/ REAR DISC (LIGHTNING)	F	R.65063	R.65063	R.65063.1S	R.65063.2S	R.65063.1C	R.65063.2C	
		R	R.65059	R.65059	R.65059.1S	R.65059.2S	R.65059.1C	R.65059.2C	
12/2/98-11/99	W/ REAR WHEEL ABS	F	R.65056	R.65056	R.65056.1S	R.65056.2S	R.65056.1C	R.65056.2C	
		R							
12/2/98-11/99	W/ 4 WHEEL ABS	F	R.65055	R.65055	R.65055.1S	R.65055.2S	R.65055.1C	R.65055.2C	
		R							
12/2/98-11/99	W/ REAR DISC (LIGHTNING)	F	R.65063	R.65063	R.65063.1S	R.65063.2S	R.65063.1C	R.65063.2C	
		R	R.65059	R.65059	R.65059.1S	R.65059.2S	R.65059.1C	R.65059.2C	
12/2/98-11/99	W/ REAR DISC (EXC LIGHTNING)	F	R.65055	R.65055	R.65055.1S	R.65055.2S	R.65055.1C	R.65055.2C	
		R	R.65059	R.65059	R.65059.1S	R.65059.2S	R.65059.1C	R.65059.2C	
12/99-12/13/01	W/ REAR DRUM (5 LUG)	F	R.65080	R.65080	R.65080.1S	R.65080.2S	R.65080.1C	R.65080.2C	
		R							
12/99-12/13/01	W/ REAR DRUM (7 LUG) W/ 4 WHEEL ABS	F	R.65060	R.65060	R.65060.1S	R.65060.2S	R.65060.1C	R.65060.2C	
		R							
12/99-12/13/01	W/ REAR DRUM (7 LUG) W/ REAR WHEEL ABS	F	R.65065	R.65065	R.65065.1S	R.65065.2S	R.65065.1C	R.65065.2C	
		R							
12/99-12/13/01	W/ REAR DISC EXC LIGHTNING (5 LUG)	F	R.65080	R.65080	R.65080.1S	R.65080.2S	R.65080.1C	R.65080.2C	
		R	R.65085	R.65085	R.65085.1S	R.65085.2S	R.65085.1C	R.65085.2C	
12/99-12/13/01	W/ REAR DISC (LIGHTNING) 5 LUG	F	R.65081	R.65081	R.65081.1S	R.65081.2S	R.65081.1C	R.65081.2C	
		R	R.65085	R.65085	R.65085.1S	R.65085.2S	R.65085.1C	R.65085.2C	
12/99-12/13/01	W/ REAR DISC (7 LUG) W/ 4 WHEEL ABS	F	R.65060	R.65060	R.65060.1S	R.65060.2S	R.65060.1C	R.65060.2C	
		R	R.65061	R.65061	R.65061.1S	R.65061.2S	R.65061.1C	R.65061.2C	
12/99-12/13/01	W/ REAR DISC (7 LUG) W/ REAR WHEEL ABS	F	R.65065	R.65065	R.65065.1S	R.65065.2S	R.65065.1C	R.65065.2C	
		R	R.65061	R.65061	R.65061.1S	R.65061.2S	R.65061.1C	R.65061.2C	
12/99-12/13/01	W/ REAR DISC (8 LUG)	F	R.65045	R.65045	R.65045.1S	R.65045.2S	R.65045.1C	R.65045.2C	
		R	R.65079	R.65079	R.65079.1S	R.65079.2S	R.65079.1C	R.65079.2C	
12/14/01-03	W/ REAR DRUM (5 LUG)	F	R.65080	R.65080	R.65080.1S	R.65080.2S	R.65080.1C	R.65080.2C	
		R							
12/14/01-03	W/ REAR DRUM (7 LUG)	F	R.65060	R.65060	R.65060.1S	R.65060.2S	R.65060.1C	R.65060.2C	
		R							
12/14/01-03	W/ REAR DISC EXC LIGHTNING (5 LUG)	F	R.65080	R.65080	R.65080.1S	R.65080.2S	R.65080.1C	R.65080.2C	
		R	R.65085	R.65085	R.65085.1S	R.65085.2S	R.65085.1C	R.65085.2C	
12/14/01-03	W/ REAR DISC (LIGHTNING) 5 LUG	F	R.65081	R.65081	R.65081.1S	R.65081.2S	R.65081.1C	R.65081.2C	
		R	R.65085	R.65085	R.65085.1S	R.65085.2S	R.65085.1C	R.65085.2C	
12/14/01-03	W/ REAR DISC (7 LUG)	F	R.65060	R.65060	R.65060.1S	R.65060.2S	R.65060.1C	R.65060.2C	
		R	R.65061	R.65061	R.65061.1S	R.65061.2S	R.65061.1C	R.65061.2C	
12/14/01-03	W/ REAR DISC (8 LUG)	F	R.65045	R.65045	R.65045.1S	R.65045.2S	R.65045.1C	R.65045.2C	
		R	R.65079	R.65079	R.65079.1S	R.65079.2S	R.65079.1C	R.65079.2C	
04-11/29/04	NEW MODEL (BASE PAYLOAD PKG) 6 LUG (EXC HERITAGE)	F	R.65098	R.65098	R.65098.1S	R.65098.2S	R.65098.1C	R.65098.2C	
		R	R.65102	R.65102	R.65102.1S	R.65102.2S	R.65102.1C	R.65102.2C	
04-11/29/04	NEW MODEL (HD PAYLOAD PKG) 7 LUG (EXC HERITAGE)	F	R.65099	R.65099	R.65099.1S	R.65099.2S	R.65099.1C	R.65099.2C	
		R	R.65103	R.65103	R.65103.1S	R.65103.2S	R.65103.1C	R.65103.2C	
04-11/29/04	HERITAGE (W/ REAR DRUM) 5 LUG	F	R.65080	R.65080	R.65080.1S	R.65080.2S	R.65080.1C	R.65080.2C	
		R							
04-11/29/04	HERITAGE (W/ REAR DRUM) 7 LUG	F	R.65060	R.65060	R.65060.1S	R.65060.2S	R.65060.1C	R.65060.2C	
		R							
04-11/29/04	HERITAGE (W/ REAR DISC) 5 LUG EXC LIGHTNING	F	R.65080	R.65080	R.65080.1S	R.65080.2S	R.65080.1C	R.65080.2C	
		R	R.65085	R.65085	R.65085.1S	R.65085.2S	R.65085.1C	R.65085.2C	
04-11/29/04	HERITAGE (W/ REAR DISC) 5 LUG LIGHTNING	F	R.65081	R.65081	R.65081.1S	R.65081.2S	R.65081.1C	R.65081.2C	
		R	R.65085	R.65085	R.65085.1S	R.65085.2S	R.65085.1C	R.65085.2C	
04-11/29/04	HERITAGE (W/ REAR DISC) 7 LUG	F	R.65060	R.65060	R.65060.1S	R.65060.2S	R.65060.1C	R.65060.2C	
		R	R.65061	R.65061	R.65061.1S	R.65061.2S	R.65061.1C	R.65061.2C	
04-11/29/04	HERITAGE (W/ REAR DISC) 8 LUG	F	R.65045	R.65045	R.65045.1S	R.65045.2S	R.65045.1C	R.65045.2C	
		R	R.65079	R.65079	R.65079.1S	R.65079.2S	R.65079.1C	R.65079.2C	
11/30/04-07	NEW MODEL (BASE PAYLOAD PKG) 6 LUG (EXC HERITAGE)	F	R.65098	R.65098	R.65098.1S	R.65098.2S	R.65098.1C	R.65098.2C	
		R	R.65102	R.65102	R.65102.1S	R.65102.2S	R.65102.1C	R.65102.2C	
11/30/04-07	NEW MODEL (HD PAYLOAD PKG) 7 LUG (EXC HERITAGE)	F	R.65099	R.65099	R.65099.1S	R.65099.2S	R.65099.1C	R.65099.2C	
		R	R.65103	R.65103	R.65103.1S	R.65103.2S	R.65103.1C	R.65103.2C	
<b>F150 (1/2 TON) PICKUP 4WD</b>									
76-93	DISC ONLY	F	R.65013	R.65013	R.65013.1S	R.65013.2S	R.65013.1C	R.65013.2C	
		R							
94-96		F	R.65041	R.65041	R.65041.1S	R.65041.2S	R.65041.1C	R.65041.2C	
		R							
97-12/1/98		F	R.65057	R.65057	R.65057.1S	R.65057.2S	R.65057.1C	R.65057.2C	
		R							
12/2/98-11/99	W/ REAR DRUM	F	R.65057	R.65057	R.65057.1S	R.65057.2S	R.65057.1C	R.65057.2C	
		R							
12/2/98-11/99	W/ REAR DISC	F	R.65057	R.65057	R.65057.1S	R.65057.2S	R.65057.1C	R.65057.2C	

BRAKE DISC		BASIC OEM		SLOTTED		DRILLED & SLOTTED		NOTES	
		MAKE/MODEL	AXLE	PART #		PART #			PART #
YEAR		F/R	LEFT	RIGHT	LEFT	RIGHT	LEFT	RIGHT	
		R	R.65059	R.65059	R.65059.1S	R.65059.2S	R.65059.1C	R.65059.2C	
12/99-03	W/ REAR DRUM (5 LUG)	F	R.65057	R.65057	R.65057.1S	R.65057.2S	R.65057.1C	R.65057.2C	
		R							
12/99-03	W/ REAR DRUM (7 LUG)	F	R.65062	R.65062	R.65062.1S	R.65062.2S	R.65062.1C	R.65062.2C	
		R							
12/99-03	W/ REAR DISC (5 LUG)	F	R.65057	R.65057	R.65057.1S	R.65057.2S	R.65057.1C	R.65057.2C	
		R	R.65085	R.65085	R.65085.1S	R.65085.2S	R.65085.1C	R.65085.2C	
12/99-03	W/ REAR DISC (7 LUG)	F	R.65062	R.65062	R.65062.1S	R.65062.2S	R.65062.1C	R.65062.2C	
		R	R.65061	R.65061	R.65061.1S	R.65061.2S	R.65061.1C	R.65061.2C	
04-11/29/04	NEW MODEL (BASE PAYLOAD PKG) 6 LUG	F	R.65100	R.65100	R.65100.1S	R.65100.2S	R.65100.1C	R.65100.2C	
		R	R.65102	R.65102	R.65102.1S	R.65102.2S	R.65102.1C	R.65102.2C	
04-11/29/04	NEW MODEL (HD PAYLOAD PKG) 7 LUG	F	R.65101	R.65101	R.65101.1S	R.65101.2S	R.65101.1C	R.65101.2C	
		R	R.65103	R.65103	R.65103.1S	R.65103.2S	R.65103.1C	R.65103.2C	
04-11/29/04	HERITAGE (W/ REAR DRUM) 5 LUG	F	R.65057	R.65057	R.65057.1S	R.65057.2S	R.65057.1C	R.65057.2C	
		R							
04-11/29/04	HERITAGE (W/ REAR DRUM) 7 LUG	F	R.65062	R.65062	R.65062.1S	R.65062.2S	R.65062.1C	R.65062.2C	
		R							
04-11/29/04	HERITAGE (W/ REAR DISC) 5 LUG	F	R.65057	R.65057	R.65057.1S	R.65057.2S	R.65057.1C	R.65057.2C	
		R	R.65085	R.65085	R.65085.1S	R.65085.2S	R.65085.1C	R.65085.2C	
04-11/29/04	HERITAGE (W/ REAR DISC) 7 LUG	F	R.65062	R.65062	R.65062.1S	R.65062.2S	R.65062.1C	R.65062.2C	
		R	R.65061	R.65061	R.65061.1S	R.65061.2S	R.65061.1C	R.65061.2C	
11/30/04-07	NEW MODEL (BASE PAYLOAD PKG) 6 LUG	F	R.65100	R.65100	R.65100.1S	R.65100.2S	R.65100.1C	R.65100.2C	
		R	R.65102	R.65102	R.65102.1S	R.65102.2S	R.65102.1C	R.65102.2C	
11/30/04-07	NEW MODEL (HD PAYLOAD PKG) 7 LUG	F	R.65101	R.65101	R.65101.1S	R.65101.2S	R.65101.1C	R.65101.2C	
		R	R.65103	R.65103	R.65103.1S	R.65103.2S	R.65103.1C	R.65103.2C	
<b>F250 (3/4 TON) 2WD PICKUP (EXC SUPER DUTY)</b>									
86-94		F	R.65026	R.65026	R.65026.1S	R.65026.2S	R.65026.1C	R.65026.2C	
		R							
95-96		F	R.65045	R.65045	R.65045.1S	R.65045.2S	R.65045.1C	R.65045.2C	
		R							
97-99	W/ REAR DRUM (W/ 4 WHEEL ABS)	F	R.65060	R.65060	R.65060.1S	R.65060.2S	R.65060.1C	R.65060.2C	
		R							
97-99	W/ REAR DRUM (W/ REAR WHEEL ABS)	F	R.65065	R.65065	R.65065.1S	R.65065.2S	R.65065.1C	R.65065.2C	
		R							
97-99	W/ REAR DRUM (8 LUG)	F	R.65045	R.65045	R.65045.1S	R.65045.2S	R.65045.1C	R.65045.2C	
		R							
97-99	W/ REAR DISC (W/ 4 WHEEL ABS)	F	R.65060	R.65060	R.65060.1S	R.65060.2S	R.65060.1C	R.65060.2C	
		R	R.65061	R.65061	R.65061.1S	R.65061.2S	R.65061.1C	R.65061.2C	
97-99	W/ REAR DISC (W/ REAR WHEEL ABS)	F	R.65065	R.65065	R.65065.1S	R.65065.2S	R.65065.1C	R.65065.2C	
		R	R.65061	R.65061	R.65061.1S	R.65061.2S	R.65061.1C	R.65061.2C	
99-00	SUPER DUTY (W/ 4 WHEEL ABS) W/ REAR DISC	F	R.65073	R.65073	R.65073.1S	R.65073.2S	R.65073.1C	R.65073.2C	
		R	R.65071	R.65071	R.65071.1S	R.65071.2S	R.65071.1C	R.65071.2C	
99-00	SUPER DUTY (W/ REAR WHEEL ABS) W/ REAR DISC	F	R.65072	R.65072	R.65072.1S	R.65072.2S	R.65072.1C	R.65072.2C	
		R	R.65071	R.65071	R.65071.1S	R.65071.2S	R.65071.1C	R.65071.2C	
01-02		F	R.65073	R.65073	R.65073.1S	R.65073.2S	R.65073.1C	R.65073.2C	
		R	R.65071	R.65071	R.65071.1S	R.65071.2S	R.65071.1C	R.65071.2C	
03-04		F	R.65104	R.65104	R.65104.1S	R.65104.2S	R.65104.1C	R.65104.2C	
		R	R.65071	R.65071	R.65071.1S	R.65071.2S	R.65071.1C	R.65071.2C	
05-07		F	R.65116	R.65116	R.65116.1S	R.65116.2S	R.65116.1C	R.65116.2C	A
		R	R.65113	R.65113	R.65113.1S	R.65113.2S	R.65113.1C	R.65113.2C	A
08		F							
		R	R.65113	R.65113	R.65113.1S	R.65113.2S	R.65113.1C	R.65113.2C	A
<b>F250 (3/4 TON) 4WD PICKUP (EXC SUPER DUTY)</b>									
80-94	DISC ONLY	F	R.65012	R.65012	R.65012.1S	R.65012.2S	R.65012.1C	R.65012.2C	
		R							
95-96		F	R.65053	R.65053	R.65053.1S	R.65053.2S	R.65053.1C	R.65053.2C	
		R							
97-99	W/ REAR DRUM (7 LUG)	F	R.65062	R.65062	R.65062.1S	R.65062.2S	R.65062.1C	R.65062.2C	
		R							
97-99	W/ REAR DRUM (8 LUG)	F	R.65053	R.65053	R.65053.1S	R.65053.2S	R.65053.1C	R.65053.2C	
		R							
97-99	W/ REAR DISC	F	R.65062	R.65062	R.65062.1S	R.65062.2S	R.65062.1C	R.65062.2C	
		R	R.65061	R.65061	R.65061.1S	R.65061.2S	R.65061.1C	R.65061.2C	
<b>F250 (3/4 TON) SUPER DUTY 4WD</b>									
90-94		F	R.65012	R.65012	R.65012.1S	R.65012.2S	R.65012.1C	R.65012.2C	
		R							
95-96		F	R.65053	R.65053	R.65053.1S	R.65053.2S	R.65053.1C	R.65053.2C	
		R							

BRAKE DISC		BASIC OEM			SLOTTED		DRILLED & SLOTTED		NOTES
		AXLE	PART #		PART #		PART #		
MAKE/MODEL	YEAR	F/R	LEFT	RIGHT	LEFT	RIGHT	LEFT	RIGHT	
97-99	W/ REAR DRUM (7 LUG)	F	R.65062	R.65062	R.65062.1S	R.65062.2S	R.65062.1C	R.65062.2C	
		R							
97-99	W/ REAR DRUM (8 LUG)	F	R.65053	R.65053	R.65053.1S	R.65053.2S	R.65053.1C	R.65053.2C	
		R							
97-99	W/ REAR DISC	F	R.65062	R.65062	R.65062.1S	R.65062.2S	R.65062.1C	R.65062.2C	
		R	R.65061	R.65061	R.65061.1S	R.65061.2S	R.65061.1C	R.65061.2C	
1/99-3/99		F	R.65067	R.65067	R.65067.1S	R.65067.2S	R.65067.1C	R.65067.2C	
		R	R.65071	R.65071	R.65071.1S	R.65071.2S	R.65071.1C	R.65071.2C	
4/99-00		F	R.65086	R.65086	R.65086.1S	R.65086.2S	R.65086.1C	R.65086.2C	
		R	R.65071	R.65071	R.65071.1S	R.65071.2S	R.65071.1C	R.65071.2C	
01-04		F	R.65086	R.65086	R.65086.1S	R.65086.2S	R.65086.1C	R.65086.2C	
		R	R.65071	R.65071	R.65071.1S	R.65071.2S	R.65071.1C	R.65071.2C	
05-07	EXC HARLEY DAVIDSON PKG	F	R.65112	R.65112	R.65112.1S	R.65112.2S	R.65112.1C	R.65112.2C	A
		R	R.65113	R.65113	R.65113.1S	R.65113.2S	R.65113.1C	R.65113.2C	A
05-07	HARLEY DAVIDSON PKG	F	R.65111	R.65111	R.65111.1S	R.65111.2S	R.65111.1C	R.65111.2C	A
		R	R.65113	R.65113	R.65113.1S	R.65113.2S	R.65113.1C	R.65113.2C	A
08		F	R.65112	R.65112	R.65112.1S	R.65112.2S	R.65112.1C	R.65112.2C	A
		R	R.65113	R.65113	R.65113.1S	R.65113.2S	R.65113.1C	R.65113.2C	A
<b>F350 (1 TON) SUPER DUTY 2WD</b>									
86-94	SRW	F	R.65026	R.65026	R.65026.1S	R.65026.2S	R.65026.1C	R.65026.2C	
		R							
82-94	DRW	F	R.65006	R.65006	R.65006.1S	R.65006.2S	R.65006.1C	R.65006.2C	
		R							
95-98	SRW	F	R.65045	R.65045	R.65045.1S	R.65045.2S	R.65045.1C	R.65045.2C	
		R							
99-02	SRW (W/ 4 WHEEL ABS)	F	R.65073	R.65073	R.65073.1S	R.65073.2S	R.65073.1C	R.65073.2C	
		R	R.65071	R.65071	R.65071.1S	R.65071.2S	R.65071.1C	R.65071.2C	
99-02	SRW (W/ REAR WHEEL ABS)	F	R.65072	R.65072	R.65072.1S	R.65072.2S	R.65072.1C	R.65072.2C	
		R	R.65071	R.65071	R.65071.1S	R.65071.2S	R.65071.1C	R.65071.2C	
99-02	DRW	F	R.65074	R.65074	R.65074.1S	R.65074.2S	R.65074.1C	R.65074.2C	
		R	R.65070	R.65070	R.65070.1S	R.65070.2S	R.65070.1C	R.65070.2C	
03-04	SRW	F	R.65104	R.65104	R.65104.1S	R.65104.2S	R.65104.1C	R.65104.2C	
		R	R.65071	R.65071	R.65071.1S	R.65071.2S	R.65071.1C	R.65071.2C	
03-04	DRW	F							
		R	R.65070	R.65070	R.65070.1S	R.65070.2S	R.65070.1C	R.65070.2C	
05-07	SRW	F	R.65116	R.65116	R.65116.1S	R.65116.2S	R.65116.1C	R.65116.2C	A
		R	R.65113	R.65113	R.65113.1S	R.65113.2S	R.65113.1C	R.65113.2C	A
05-07	DRW	F							
		R	R.65114	R.65114	R.65114.1S	R.65114.2S	R.65114.1C	R.65114.2C	A
08	SRW	F							
		R	R.65113	R.65113	R.65113.1S	R.65113.2S	R.65113.1C	R.65113.2C	A
08	DRW	F							
		R	R.65114	R.65114	R.65114.1S	R.65114.2S	R.65114.1C	R.65114.2C	A
<b>F350 (1 TON) SUPER DUTY 4WD</b>									
80-94	DISC ONLY	F	R.65012	R.65012	R.65012.1S	R.65012.2S	R.65012.1C	R.65012.2C	
		R							
95-98		F	R.65053	R.65053	R.65053.1S	R.65053.2S	R.65053.1C	R.65053.2C	
		R							
99-3/99	SRW	F	R.65067	R.65067	R.65067.1S	R.65067.2S	R.65067.1C	R.65067.2C	
		R	R.65071	R.65071	R.65071.1S	R.65071.2S	R.65071.1C	R.65071.2C	
99-3/99	DRW	F	R.65067	R.65067	R.65067.1S	R.65067.2S	R.65067.1C	R.65067.2C	
		R	R.65070	R.65070	R.65070.1S	R.65070.2S	R.65070.1C	R.65070.2C	
4/99-04	SRW	F	R.65086	R.65086	R.65086.1S	R.65086.2S	R.65086.1C	R.65086.2C	
		R	R.65071	R.65071	R.65071.1S	R.65071.2S	R.65071.1C	R.65071.2C	
4/99-04	DRW	F	R.65086	R.65086	R.65086.1S	R.65086.2S	R.65086.1C	R.65086.2C	
		R	R.65070	R.65070	R.65070.1S	R.65070.2S	R.65070.1C	R.65070.2C	
05-07	SRW (EXC HARLEY DAVIDSON PKG)	F	R.65112	R.65112	R.65112.1S	R.65112.2S	R.65112.1C	R.65112.2C	A
		R	R.65113	R.65113	R.65113.1S	R.65113.2S	R.65113.1C	R.65113.2C	A
05-07	SRW (HARLEY DAVIDSON PKG)	F	R.65111	R.65111	R.65111.1S	R.65111.2S	R.65111.1C	R.65111.2C	A
		R	R.65113	R.65113	R.65113.1S	R.65113.2S	R.65113.1C	R.65113.2C	A
05-07	DRW	F							
		R	R.65114	R.65114	R.65114.1S	R.65114.2S	R.65114.1C	R.65114.2C	A
08	SRW	F	R.65112	R.65112	R.65112.1S	R.65112.2S	R.65112.1C	R.65112.2C	A
		R	R.65113	R.65113	R.65113.1S	R.65113.2S	R.65113.1C	R.65113.2C	A
08	DRW	F							
		R	R.65114	R.65114	R.65114.1S	R.65114.2S	R.65114.1C	R.65114.2C	A
<b>F450, F47, F550 (1 TON) 2WD &amp; 4WD SUPER DUTY</b>									
99-3/99	2WD	F	R.65087	R.65087	R.65087.1S	R.65087.2S	R.65087.1C	R.65087.2C	



BRAKE DISC		BASIC OEM		SLOTTED		DRILLED & SLOTTED		NOTES	
		MAKE/MODEL	AXLE	PART #		PART #			PART #
YEAR		F/R	LEFT	RIGHT	LEFT	RIGHT	LEFT	RIGHT	
99-3/99	4WD	R	R.65069	R.65069	R.65069.1S	R.65069.2S	R.65069.1C	R.65069.2C	
		F	R.65068	R.65068	R.65068.1S	R.65068.2S	R.65068.1C	R.65068.2C	
		R	R.65069	R.65069	R.65069.1S	R.65069.2S	R.65069.1C	R.65069.2C	
4/99-01		F	R.65087	R.65087	R.65087.1S	R.65087.2S	R.65087.1C	R.65087.2C	
		R	R.65069	R.65069	R.65069.1S	R.65069.2S	R.65069.1C	R.65069.2C	
02-04	W/O ABS RING	F	R.65087	R.65087	R.65087.1S	R.65087.2S	R.65087.1C	R.65087.2C	
		R	R.65069	R.65069	R.65069.1S	R.65069.2S	R.65069.1C	R.65069.2C	
02-04	W/ ABS RING	F	R.65087	R.65087	R.65087.1S	R.65087.2S	R.65087.1C	R.65087.2C	
		R	R.65092	R.65092	R.65092.1S	R.65092.2S	R.65092.1C	R.65092.2C	
05-08		F	R.65111	R.65111	R.65111.1S	R.65111.2S	R.65111.1C	R.65111.2C	A
		R	R.65115	R.65115	R.65115.1S	R.65115.2S	R.65115.1C	R.65115.2C	A
<b>F53, 59 (1 TON)</b>									
99-01		F	R.65069	R.65069	R.65069.1S	R.65069.2S	R.65069.1C	R.65069.2C	
		R	R.65069	R.65069	R.65069.1S	R.65069.2S	R.65069.1C	R.65069.2C	
02-06	W/O ABS RING	F	R.65069	R.65069	R.65069.1S	R.65069.2S	R.65069.1C	R.65069.2C	
		R	R.65069	R.65069	R.65069.1S	R.65069.2S	R.65069.1C	R.65069.2C	
02-06	W/ ABS RING	F	R.65069	R.65069	R.65069.1S	R.65069.2S	R.65069.1C	R.65069.2C	
		R	R.65092	R.65092	R.65092.1S	R.65092.2S	R.65092.1C	R.65092.2C	
<b>FOCUS (EXC SVT)</b>									
00		F	R.61061	R.61061	R.61061.1S	R.61061.2S	R.61061.1C	R.61061.2C	
		R							
01-04	W/ REAR DRUM	F	R.61061	R.61061	R.61061.1S	R.61061.2S	R.61061.1C	R.61061.2C	
		R							
01-04	W/ REAR DISC	F	R.61061	R.61061	R.61061.1S	R.61061.2S	R.61061.1C	R.61061.2C	
		R	R.61070	R.61070	R.61070.1S	R.61070.2S	R.61070.1C	R.61070.2C	
05-07	W/ REAR DRUM	F	R.61082	R.61082	R.61082.1S	R.61082.2S	R.61082.1C	R.61082.2C	
		R							
05-07	W/ REAR DISC	F	R.61082	R.61082	R.61082.1S	R.61082.2S	R.61082.1C	R.61082.2C	
		R	R.61070	R.61070	R.61070.1S	R.61070.2S	R.61070.1C	R.61070.2C	
<b>FOCUS SVT</b>									
02-04		F	R.61071	R.61071	R.61071.1S	R.61071.2S	R.61071.1C	R.61071.2C	
		R	R.61074	R.61074	R.61074.1S	R.61074.2S	R.61074.1C	R.61074.2C	
<b>FREESTAR</b>									
04-07		F	R.61078	R.61078	R.61078.1S	R.61078.2S	R.61078.1C	R.61078.2C	
		R	R.61079	R.61079	R.61079.1S	R.61079.2S	R.61079.1C	R.61079.2C	
<b>FREESTYLE</b>									
05-07		F	R.61080	R.61080	R.61080.1S	R.61080.2S	R.61080.1C	R.61080.2C	
		R	R.61081	R.61081	R.61081.1S	R.61081.2S	R.61081.1C	R.61081.2C	
<b>FUSION</b>									
06-07		F	R.61088	R.61088	R.61088.1S	R.61088.2S	R.61088.1C	R.61088.2C	
		R	R.45064	R.45064	R.45064.1S	R.45064.2S	R.45064.1C	R.45064.2C	
<b>MUSTANG</b>									
74-78		F	R.61008	R.61008	R.61008.1S	R.61008.2S	R.61008.1C	R.61008.2C	A
		R							
79	V8	F	R.61011	R.61011	R.61011.1S	R.61011.2S	R.61011.1C	R.61011.2C	A
		R							
79-81	EXC V8	F	R.61016	R.61016	R.61016.1S	R.61016.2S	R.61016.1C	R.61016.2C	A
		R							
82-83		F	R.61011	R.61011	R.61011.1S	R.61011.2S	R.61011.1C	R.61011.2C	A
		R							
84-86	EXC SVO (REAR DRUM)	F	R.61011	R.61011	R.61011.1S	R.61011.2S	R.61011.1C	R.61011.2C	A
		R							
84-86	SVO (REAR DISC)	F	R.61018	R.61018	R.61018.1S	R.61018.2S	R.61018.1C	R.61018.2C	A
		R	R.61021	R.61021	R.61021.1S	R.61021.2S	R.61021.1C	R.61021.2C	A
87-92	4 CYL.	F	R.61011	R.61011	R.61011.1S	R.61011.2S	R.61011.1C	R.61011.2C	A
		R							
87-92	8 CYL. (W/ REAR DRUM)	F	R.61026	R.61026	R.61026.1S	R.61026.2S	R.61026.1C	R.61026.2C	
		R							
93	4 CYL.	F	R.61011	R.61011	R.61011.1S	R.61011.2S	R.61011.1C	R.61011.2C	A
		R							
93	8 CYL. (W/ REAR DRUM)	F	R.61026	R.61026	R.61026.1S	R.61026.2S	R.61026.1C	R.61026.2C	
		R							
93	8 CYL. (EXC COBRA) W/ REAR DISC	F	R.61026	R.61026	R.61026.1S	R.61026.2S	R.61026.1C	R.61026.2C	
		R	R.61023	R.61023	R.61023.1S	R.61023.2S	R.61023.1C	R.61023.2C	
93	8 CYL. (COBRA) W/ REAR DISC	F	R.61054	R.61054	R.61054.1S	R.61054.2S	R.61054.1C	R.61054.2C	
		R	R.61023	R.61023	R.61023.1S	R.61023.2S	R.61023.1C	R.61023.2C	
94-04	EXC COBRA	F	R.61041	R.61041	R.61041.1S	R.61041.2S	R.61041.1C	R.61041.2C	
		R	R.61042	R.61042	R.61042.1S	R.61042.2S	R.61042.1C	R.61042.2C	

BRAKE DISC		BASIC OEM		SLOTTED		DRILLED & SLOTTED		NOTES	
		AXLE	PART #		PART #		PART #		
MAKE/MODEL	YEAR	F/R	LEFT	RIGHT	LEFT	RIGHT	LEFT	RIGHT	
94-04	COBRA	F	R.61044	R.61045	R.61044.1S	R.61044.2S	R.61044.1C	R.61044.2C	B
		R	R.61046	R.61046	R.61046.1S	R.61046.2S	R.61046.1C	R.61046.2C	
05-07	V6 (4.0L)	F	R.61085	R.61085	R.61085.1S	R.61085.2S	R.61085.1C	R.61085.2C	
		R	R.61087	R.61087	R.61087.1S	R.61087.2S	R.61087.1C	R.61087.2C	
05-07	GT V8 (4.6L)	F	R.61086	R.61086	R.61086.1S	R.61086.2S	R.61086.1C	R.61086.2C	
		R	R.61087	R.61087	R.61087.1S	R.61087.2S	R.61087.1C	R.61087.2C	
07	SHELBY	F	R.61089	R.61089	R.61089.1S	R.61089.2S	R.61089.1C	R.61089.2C	C
		R	R.61087	R.61087	R.61087.1S	R.61087.2S	R.61087.1C	R.61087.2C	
<b>PROBE</b>									
93-97	W/ REAR DRUM	F	R.45048	R.45048	R.45048.1S	R.45048.2S	R.45048.1C	R.45048.2C	
		R							
93-97	W/ REAR DISC	F	R.45048	R.45048	R.45048.1S	R.45048.2S	R.45048.1C	R.45048.2C	
		R	R.45049	R.45049	R.45049.1S	R.45049.2S	R.45049.1C	R.45049.2C	
<b>RANGER 2WD</b>									
98-05	W/ REAR DRUM	F	R.65051	R.65051	R.65051.1S	R.65051.2S	R.65051.1C	R.65051.2C	
		R							
98-05	W/ REAR DISC	F	R.65051	R.65051	R.65051.1S	R.65051.2S	R.65051.1C	R.65051.2C	
		R	R.65052	R.65052	R.65052.1S	R.65052.2S	R.65052.1C	R.65052.2C	
06-07		F	R.65051	R.65051	R.65051.1S	R.65051.2S	R.65051.1C	R.65051.2C	
		R							
<b>RANGER 4WD</b>									
98-02		F	R.65054	R.65054	R.65054.1S	R.65054.2S	R.65054.1C	R.65054.2C	
		R							
03-07		F	R.65082	R.65082	R.65082.1S	R.65082.2S	R.65082.1C	R.65082.2C	
		R							
<b>TAURUS</b>									
94-00	W/ REAR DRUM	F	R.61051	R.61051	R.61051.1S	R.61051.2S	R.61051.1C	R.61051.2C	
		R							
94-00	W/ REAR DISC	F	R.61051	R.61051	R.61051.1S	R.61051.2S	R.61051.1C	R.61051.2C	
		R	R.61039	R.61039	R.61039.1S	R.61039.2S	R.61039.1C	R.61039.2C	
01-07	W/ REAR DRUM	F	R.61049	R.61049	R.61049.1S	R.61049.2S	R.61049.1C	R.61049.2C	
		R							
01-07	W/ REAR DISC	F	R.61049	R.61049	R.61049.1S	R.61049.2S	R.61049.1C	R.61049.2C	
		R	R.61039	R.61039	R.61039.1S	R.61039.2S	R.61039.1C	R.61039.2C	
08		F	R.61080	R.61080	R.61080.1S	R.61080.2S	R.61080.1C	R.61080.2C	
		R	R.61081	R.61081	R.61081.1S	R.61081.2S	R.61081.1C	R.61081.2C	
<b>TAURUS SHO</b>									
94-95		F	R.61051	R.61051	R.61051.1S	R.61051.2S	R.61051.1C	R.61051.2C	
		R	R.61039	R.61039	R.61039.1S	R.61039.2S	R.61039.1C	R.61039.2C	
96-99		F	R.61049	R.61049	R.61049.1S	R.61049.2S	R.61049.1C	R.61049.2C	
		R	R.61039	R.61039	R.61039.1S	R.61039.2S	R.61039.1C	R.61039.2C	
<b>THUNDERBIRD</b>									
91-92	W/ REAR DRUM	F	R.61051	R.61051	R.61051.1S	R.61051.2S	R.61051.1C	R.61051.2C	
		R							
91-92	W/ REAR DISC	F	R.61051	R.61051	R.61051.1S	R.61051.2S	R.61051.1C	R.61051.2C	
		R	R.61019	R.61019	R.61019.1S	R.61019.2S	R.61019.1C	R.61019.2C	
93-95	W/ REAR DRUM	F	R.61051	R.61051	R.61051.1S	R.61051.2S	R.61051.1C	R.61051.2C	
		R							
93-95	W/ REAR DISC	F	R.61051	R.61051	R.61051.1S	R.61051.2S	R.61051.1C	R.61051.2C	
		R	R.61037	R.61037	R.61037.1S	R.61037.2S	R.61037.1C	R.61037.2C	
96-97	W/ REAR DRUM	F	R.61051	R.61051	R.61051.1S	R.61051.2S	R.61051.1C	R.61051.2C	
		R							
96-97	W/ REAR DISC (EXC SPORT PKG)	F	R.61051	R.61051	R.61051.1S	R.61051.2S	R.61051.1C	R.61051.2C	
		R	R.61037	R.61037	R.61037.1S	R.61037.2S	R.61037.1C	R.61037.2C	
96-97	W/ REAR DISC (W/ SPORT PKG)	F	R.61049	R.61049	R.61049.1S	R.61049.2S	R.61049.1C	R.61049.2C	
		R	R.61037	R.61037	R.61037.1S	R.61037.2S	R.61037.1C	R.61037.2C	
02-05		F	R.61060	R.61060	R.61060.1S	R.61060.2S	R.61060.1C	R.61060.2C	
		R	R.61062	R.61062	R.61062.1S	R.61062.2S	R.61062.1C	R.61062.2C	
<b>WINDSTAR</b>									
95-98	W/ REAR DRUM	F	R.61051	R.61051	R.61051.1S	R.61051.2S	R.61051.1C	R.61051.2C	
		R							
95-98	W/ REAR DISC	F	R.61051	R.61051	R.61051.1S	R.61051.2S	R.61051.1C	R.61051.2C	
		R	R.65047	R.65047	R.65047.1S	R.65047.2S	R.65047.1C	R.65047.2C	
99-03	W/ REAR DRUM	F	R.61057	R.61057	R.61057.1S	R.61057.2S	R.61057.1C	R.61057.2C	
		R							
99-03	W/ REAR DISC	F	R.61057	R.61057	R.61057.1S	R.61057.2S	R.61057.1C	R.61057.2C	
		R	R.65047	R.65047	R.65047.1S	R.65047.2S	R.65047.1C	R.65047.2C	

BRAKE DISC		BASIC OEM		SLOTTED		DRILLED & SLOTTED		NOTES	
MAKE/MODEL		AXLE	PART #		PART #		PART #		NOTES
YEAR		F/R	LEFT	RIGHT	LEFT	RIGHT	LEFT	RIGHT	
<b>GMC TRUCK, VAN</b>									
<b>CANYON</b>									
04-07	ALL MODEL	F R	R.66056	R.66056	R.66056.1S	R.66056.2S	R.66056.1C	R.66056.2C	
<b>C1500 SERIES (1/2 TON) PICKUP 2WD</b>									
88-91	STD CAB	F R	R.66010	R.66010	R.66010.1S	R.66010.2S	R.66010.1C	R.66010.2C	
89-91	EXT CAB	F R	R.66011	R.66011	R.66011.1S	R.66011.2S	R.66011.1C	R.66011.2C	
92-94		F R	R.66011	R.66011	R.66011.1S	R.66011.2S	R.66011.1C	R.66011.2C	
95-99		F R	R.66025	R.66025	R.66025.1S	R.66025.2S	R.66025.1C	R.66025.2C	
<b>C2500 SERIES (3/4 TON) PICKUP 2WD</b>									
90-91	11" REAR DRUM	F R	R.66012	R.66012	R.66012.1S	R.66012.2S	R.66012.1C	R.66012.2C	
90-91	13" REAR DRUM	F R	R.66014	R.66014	R.66014.1S	R.66014.2S	R.66014.1C	R.66014.2C	
92-93	11" REAR DRUM	F R	R.66012	R.66012	R.66012.1S	R.66012.2S	R.66012.1C	R.66012.2C	
92-93	13" REAR DRUM W/ REAR WHEEL ABS	F R	R.66014	R.66014	R.66014.1S	R.66014.2S	R.66014.1C	R.66014.2C	
92-93	13" REAR DRUM W/ 4 WHEEL ABS	F R	R.66027	R.66027	R.66027.1S	R.66027.2S	R.66027.1C	R.66027.2C	
94-96	11" REAR DRUM W/ REAR WHEEL ABS	F R	R.66012	R.66012	R.66012.1S	R.66012.2S	R.66012.1C	R.66012.2C	
94-96	11" REAR DRUM W/ 4 WHEEL ABS	F R	R.66035	R.66035	R.66035.1S	R.66035.2S	R.66035.1C	R.66035.2C	
94-96	13" REAR DRUM W/ REAR WHEEL ABS	F R	R.66014	R.66014	R.66014.1S	R.66014.2S	R.66014.1C	R.66014.2C	
94-96	13" REAR DRUM W/ 4 WHEEL ABS	F R	R.66027	R.66027	R.66027.1S	R.66027.2S	R.66027.1C	R.66027.2C	
97-98	11" REAR DRUM	F R	R.66035	R.66035	R.66035.1S	R.66035.2S	R.66035.1C	R.66035.2C	
97-98	13" REAR DRUM	F R	R.66027	R.66027	R.66027.1S	R.66027.2S	R.66027.1C	R.66027.2C	
99-00	13" REAR DRUM	F R	R.66027	R.66027	R.66027.1S	R.66027.2S	R.66027.1C	R.66027.2C	
<b>C3500 SERIES (1 TON) PICKUP 2WD</b>									
90-91	SRW	F R	R.66014	R.66014	R.66014.1S	R.66014.2S	R.66014.1C	R.66014.2C	
90-91	DRW (W/ REAR DISC)	F R	R.66015 R.66018	R.66015 R.66018	R.66015.1S R.66018.1S	R.66015.2S R.66018.2S	R.66015.1C R.66018.1C	R.66015.2C R.66018.2C	
92-94	SRW (W/O ABS)	F R	R.66014	R.66014	R.66014.1S	R.66014.2S	R.66014.1C	R.66014.2C	
92-94	SRW (W/ ABS)	F R	R.66027	R.66027	R.66027.1S	R.66027.2S	R.66027.1C	R.66027.2C	
92-94	DRW (W/ REAR DISC)	F R	R.66015 R.66018	R.66015 R.66018	R.66015.1S R.66018.1S	R.66015.2S R.66018.2S	R.66015.1C R.66018.1C	R.66015.2C R.66018.2C	
95-96	SRW (W/O ABS)	F R	R.66014	R.66014	R.66014.1S	R.66014.2S	R.66014.1C	R.66014.2C	
95-96	SRW (W/ ABS)	F R	R.66027	R.66027	R.66027.1S	R.66027.2S	R.66027.1C	R.66027.2C	
95-96	DRW (W/ REAR DISC)	F R	R.66031	R.66031	R.66031.1S	R.66031.2S	R.66031.1C	R.66031.2C	
97-00	SRW (EXC EXT CAB)	F R	R.66027	R.66027	R.66027.1S	R.66027.2S	R.66027.1C	R.66027.2C	
97-00	DRW (W/ REAR DISC)	F R	R.66031	R.66031	R.66031.1S	R.66031.2S	R.66031.1C	R.66031.2C	
01-02		F R	R.66031	R.66031	R.66031.1S	R.66031.2S	R.66031.1C	R.66031.2C	
<b>DENALI (SEE YUKON)</b>									
<b>ENVOY</b>									
98-01		F R	R.66038 R.66036	R.66038 R.66036	R.66038.1S R.66036.1S	R.66038.2S R.66036.2S	R.66038.1C R.66036.1C	R.66038.2C R.66036.2C	
02-05	EXC XL, XUV (5 PASSENGER)	F R	R.66051 R.66052	R.66051 R.66052	R.66051.1S R.66052.1S	R.66051.2S R.66052.2S	R.66051.1C R.66052.1C	R.66051.2C R.66052.2C	A
02-05	XL, XUV (7 PASSENGER)	F	R.66053	R.66053	R.66053.1S	R.66053.2S	R.66053.1C	R.66053.2C	A

BRAKE DISC		BASIC OEM		SLOTTED		DRILLED & SLOTTED		NOTES	
		MAKE/MODEL	AXLE	PART #		PART #			PART #
YEAR		F/R	LEFT	RIGHT	LEFT	RIGHT	LEFT	RIGHT	
06-07	REG (4.2L ENG)	R	R.66052	R.66052	R.66052.1S	R.66052.2S	R.66052.1C	R.66052.2C	A
		F	R.66063	R.66063	R.66063.1S	R.66063.2S	R.66063.1C	R.66063.2C	
		R	R.66052	R.66052	R.66052.1S	R.66052.2S	R.66052.1C	R.66052.2C	A
06-07	REG (5.3L ENG)	F	R.66053	R.66053	R.66053.1S	R.66053.2S	R.66053.1C	R.66053.2C	A
		R	R.66052	R.66052	R.66052.1S	R.66052.2S	R.66052.1C	R.66052.2C	A
06-07	EXT (4.2L, 5.3L ENG)	F	R.66053	R.66053	R.66053.1S	R.66053.2S	R.66053.1C	R.66053.2C	A
		R	R.66052	R.66052	R.66052.1S	R.66052.2S	R.66052.1C	R.66052.2C	A
<b>JIMMY MIDSIZE SUV (2WD)</b>									
91-95	W/O 4 WHEEL ABS	F	R.62013	R.62013	R.62013.1S	R.62013.2S	R.62013.1C	R.62013.2C	
		R							
91-95	W/ 4 WHEEL ABS	F	R.66017	R.66017	R.66017.1S	R.66017.2S	R.66017.1C	R.66017.2C	
		R							
96-97		F	R.66017	R.66017	R.66017.1S	R.66017.2S	R.66017.1C	R.66017.2C	
		R							
98-02		F	R.66038	R.66038	R.66038.1S	R.66038.2S	R.66038.1C	R.66038.2C	
		R	R.66039	R.66039	R.66039.1S	R.66039.2S	R.66039.1C	R.66039.2C	
<b>JIMMY MIDSIZE SUV (4WD)</b>									
89-97		F	R.66006	R.66006	R.66006.1S	R.66006.2S	R.66006.1C	R.66006.2C	
		R							
97-02	W/ REAR DISC	F	R.66038	R.66038	R.66038.1S	R.66038.2S	R.66038.1C	R.66038.2C	
		R	R.66036	R.66036	R.66036.1S	R.66036.2S	R.66036.1C	R.66036.2C	
<b>K1500 SERIES (1/2 TON) PICKUP 4WD</b>									
88-99	EXC STD CAB W/ STD CH	F	R.66009	R.66009	R.66009.1S	R.66009.2S	R.66009.1C	R.66009.2C	
		R							
<b>K2500 SERIES (3/4 TON) PICKUP 4WD</b>									
90-98	11" REAR DRUM	F	R.66009	R.66009	R.66009.1S	R.66009.2S	R.66009.1C	R.66009.2C	
		R							
90-00	13" REAR DRUM	F	R.62042	R.62042	R.62042.1S	R.62042.2S	R.62042.1C	R.62042.2C	
		R							
<b>K3500 SERIES (1 TON) PICKUP 4WD</b>									
90-91	SRW	F	R.62042	R.62042	R.62042.1S	R.62042.2S	R.62042.1C	R.62042.2C	
		R							
90-91	DRW	F	R.66004	R.66004	R.66004.1S	R.66004.2S	R.66004.1C	R.66004.2C	
		R							
92-96	SRW	F	R.62042	R.62042	R.62042.1S	R.62042.2S	R.62042.1C	R.62042.2C	
		R							
92-96	DRW (327MM DISC)	F	R.66004	R.66004	R.66004.1S	R.66004.2S	R.66004.1C	R.66004.2C	
		R							
92-96	DRW (317MM DISC)	F	R.66026	R.66026	R.66026.1S	R.66026.2S	R.66026.1C	R.66026.2C	
		R							
97-00	SRW (EXC EXT CAB)	F	R.62042	R.62042	R.62042.1S	R.62042.2S	R.62042.1C	R.62042.2C	
		R							
97-00	SRW (EXT CAB)	F	R.66004	R.66004	R.66004.1S	R.66004.2S	R.66004.1C	R.66004.2C	
		R							
97-00	DRW (327MM DISC)	F	R.66004	R.66004	R.66004.1S	R.66004.2S	R.66004.1C	R.66004.2C	
		R							
97-00	DRW (317MM DISC)	F	R.66026	R.66026	R.66026.1S	R.66026.2S	R.66026.1C	R.66026.2C	
		R							
<b>SAFARI VAN</b>									
90-95	2WD (W/ REAR WHEEL ABS)	F	R.62012	R.62012	R.62012.1S	R.62012.2S	R.62012.1C	R.62012.2C	
		R							
90-95	2WD (W/ 4 WHEEL ABS)	F	R.66016	R.66016	R.66016.1S	R.66016.2S	R.66016.1C	R.66016.2C	
		R							
90-95	4WD	F	R.66022	R.66022	R.66022.1S	R.66022.2S	R.66022.1C	R.66022.2C	
		R							
96-02	2WD	F	R.66016	R.66016	R.66016.1S	R.66016.2S	R.66016.1C	R.66016.2C	
		R							
96-02	4WD	F	R.66022	R.66022	R.66022.1S	R.66022.2S	R.66022.1C	R.66022.2C	
		R							
03-05	2WD, 4WD	F	R.66040	R.66040	R.66040.1S	R.66040.2S	R.66040.1C	R.66040.2C	
		R	R.66041	R.66041	R.66041.1S	R.66041.2S	R.66041.1C	R.66041.2C	
<b>SAVANA 1500 (1/2 TON) VAN</b>									
96-02		F	R.66025	R.66025	R.66025.1S	R.66025.2S	R.66025.1C	R.66025.2C	
		R							
03-07		F	R.66040	R.66040	R.66040.1S	R.66040.2S	R.66040.1C	R.66040.2C	
		R	R.66045	R.66045	R.66045.1S	R.66045.2S	R.66045.1C	R.66045.2C	
<b>SAVANA 2500 (3/4 TON) VAN</b>									
96-00	6 LUG	F	R.66035	R.66035	R.66035.1S	R.66035.2S	R.66035.1C	R.66035.2C	

BRAKE DISC		BASIC OEM		SLOTTED		DRILLED & SLOTTED		NOTES	
MAKE/MODEL		AXLE	PART #		PART #		PART #		
YEAR		F/R	LEFT	RIGHT	LEFT	RIGHT	LEFT		RIGHT
		R							
96-00	8 LUG	F	R.66027	R.66027	R.66027.1S	R.66027.2S	R.66027.1C	R.66027.2C	
		R							
01-02	7300 LBS. GVW (6 LUG)	F	R.66035	R.66035	R.66035.1S	R.66035.2S	R.66035.1C	R.66035.2C	
		R							
01-02	7700-8600 LBS. GVW (GAS ENG) 8 LUG	F	R.66027	R.66027	R.66027.1S	R.66027.2S	R.66027.1C	R.66027.2C	
		R							
01-02	7700-8600 LBS. GVW (DIESEL ENG) 8 LUG	F	R.66049	R.66049	R.66049.1S	R.66049.2S	R.66049.1C	R.66049.2C	
		R							
03-05	7300 LBS. GVW	F	R.66040	R.66040	R.66040.1S	R.66040.2S	R.66040.1C	R.66040.2C	
		R	R.66054	R.66054	R.66054.1S	R.66054.2S	R.66054.1C	R.66054.2C	
03-05	8500 LBS. GVW	F	R.66042	R.66042	R.66042.1S	R.66042.2S	R.66042.1C	R.66042.2C	
		R	R.66043	R.66043	R.66043.1S	R.66043.2S	R.66043.1C	R.66043.2C	
06-07	8500 LBS. GVW (GAS ENG)	F	R.66042	R.66042	R.66042.1S	R.66042.2S	R.66042.1C	R.66042.2C	
		R	R.66043	R.66043	R.66043.1S	R.66043.2S	R.66043.1C	R.66043.2C	
06-07	8500 LBS. GVW (DIESEL ENG)	F	R.66042	R.66042	R.66042.1S	R.66042.2S	R.66042.1C	R.66042.2C	
		R	R.66044	R.66044	R.66044.1S	R.66044.2S	R.66044.1C	R.66044.2C	
<b>SAVANA 3500 (1 TON) VAN</b>									
96-00	SRW	F	R.66027	R.66027	R.66027.1S	R.66027.2S	R.66027.1C	R.66027.2C	
		R							
01	SRW (G315 CAB, CHASSIS)	F	R.66027	R.66027	R.66027.1S	R.66027.2S	R.66027.1C	R.66027.2C	
		R							
01	SRW (EXC G315 CAB, CHASSIS)	F	R.66049	R.66049	R.66049.1S	R.66049.2S	R.66049.1C	R.66049.2C	
		R							
02	SRW	F	R.66049	R.66049	R.66049.1S	R.66049.2S	R.66049.1C	R.66049.2C	
		R							
03-04	SRW	F	R.66059	R.66059	R.66059.1S	R.66059.2S	R.66059.1C	R.66059.2C	
		R	R.66044	R.66044	R.66044.1S	R.66044.2S	R.66044.1C	R.66044.2C	
03-04	DRW	F	R.66059	R.66059	R.66059.1S	R.66059.2S	R.66059.1C	R.66059.2C	
		R	R.66050	R.66050	R.66050.1S	R.66050.2S	R.66050.1C	R.66050.2C	
05-07	SRW (86MM HIGH)	F	R.66059	R.66059	R.66059.1S	R.66059.2S	R.66059.1C	R.66059.2C	
		R	R.66043	R.66043	R.66043.1S	R.66043.2S	R.66043.1C	R.66043.2C	
05-07	SRW (91MM HIGH)	F	R.66059	R.66059	R.66059.1S	R.66059.2S	R.66059.1C	R.66059.2C	
		R	R.66044	R.66044	R.66044.1S	R.66044.2S	R.66044.1C	R.66044.2C	
05-07	DRW	F	R.66059	R.66059	R.66059.1S	R.66059.2S	R.66059.1C	R.66059.2C	
		R	R.66050	R.66050	R.66050.1S	R.66050.2S	R.66050.1C	R.66050.2C	
<b>SIERRA 1500 (1/2 TON) 2WD</b>									
99-00		F	R.66040	R.66040	R.66040.1S	R.66040.2S	R.66040.1C	R.66040.2C	
		R	R.66041	R.66041	R.66041.1S	R.66041.2S	R.66041.1C	R.66041.2C	
01	2 DR	F	R.66040	R.66040	R.66040.1S	R.66040.2S	R.66040.1C	R.66040.2C	
		R	R.66041	R.66041	R.66041.1S	R.66041.2S	R.66041.1C	R.66041.2C	
01	4 DR (HD)	F	R.66042	R.66042	R.66042.1S	R.66042.2S	R.66042.1C	R.66042.2C	
		R	R.66043	R.66043	R.66043.1S	R.66043.2S	R.66043.1C	R.66043.2C	
02	REG CAB (2 WHEEL STEERING)	F	R.66040	R.66040	R.66040.1S	R.66040.2S	R.66040.1C	R.66040.2C	
		R	R.66041	R.66041	R.66041.1S	R.66041.2S	R.66041.1C	R.66041.2C	
02	EXT CAB (4 WHEEL STEERING)	F	R.66040	R.66040	R.66040.1S	R.66040.2S	R.66040.1C	R.66040.2C	
		R	R.66045	R.66045	R.66045.1S	R.66045.2S	R.66045.1C	R.66045.2C	
02	4 DR (HD)	F	R.66042	R.66042	R.66042.1S	R.66042.2S	R.66042.1C	R.66042.2C	
		R	R.66043	R.66043	R.66043.1S	R.66043.2S	R.66043.1C	R.66043.2C	
03	REG CAB (2 WHEEL STEERING)	F	R.66040	R.66040	R.66040.1S	R.66040.2S	R.66040.1C	R.66040.2C	
		R	R.66041	R.66041	R.66041.1S	R.66041.2S	R.66041.1C	R.66041.2C	
03	EXT CAB (2 WHEEL STEERING)	F	R.66040	R.66040	R.66040.1S	R.66040.2S	R.66040.1C	R.66040.2C	
		R	R.66041	R.66041	R.66041.1S	R.66041.2S	R.66041.1C	R.66041.2C	
03	EXT CAB (4 WHEEL STEERING) 330MM REAR DISC	F	R.66040	R.66040	R.66040.1S	R.66040.2S	R.66040.1C	R.66040.2C	
		R	R.66045	R.66045	R.66045.1S	R.66045.2S	R.66045.1C	R.66045.2C	
03	EXT CAB (4 WHEEL STEERING) 325MM REAR DISC	F	R.66040	R.66040	R.66040.1S	R.66040.2S	R.66040.1C	R.66040.2C	
		R	R.66041	R.66041	R.66041.1S	R.66041.2S	R.66041.1C	R.66041.2C	
03	4 DR (HD) 2 WHEEL STEERING	F	R.66042	R.66042	R.66042.1S	R.66042.2S	R.66042.1C	R.66042.2C	
		R	R.66043	R.66043	R.66043.1S	R.66043.2S	R.66043.1C	R.66043.2C	
03	4 DR (HD) 4 WHEEL STEERING	F	R.66042	R.66042	R.66042.1S	R.66042.2S	R.66042.1C	R.66042.2C	
		R	R.66055	R.66055	R.66055.1S	R.66055.2S	R.66055.1C	R.66055.2C	
04	REG CAB	F	R.66040	R.66040	R.66040.1S	R.66040.2S	R.66040.1C	R.66040.2C	
		R	R.66041	R.66041	R.66041.1S	R.66041.2S	R.66041.1C	R.66041.2C	
04	CREW CAB	F	R.66040	R.66040	R.66040.1S	R.66040.2S	R.66040.1C	R.66040.2C	
		R	R.66045	R.66045	R.66045.1S	R.66045.2S	R.66045.1C	R.66045.2C	
04	EXT CAB (2 WHEEL STEERING) STD DUTY	F	R.66040	R.66040	R.66040.1S	R.66040.2S	R.66040.1C	R.66040.2C	
		R	R.66041	R.66041	R.66041.1S	R.66041.2S	R.66041.1C	R.66041.2C	
04	EXT CAB (4 WHEEL STEERING)	F	R.66040	R.66040	R.66040.1S	R.66040.2S	R.66040.1C	R.66040.2C	

BRAKE DISC		BASIC OEM		SLOTTED		DRILLED & SLOTTED		NOTES	
MAKE/MODEL		AXLE	PART #		PART #		PART #		
YEAR		F/R	LEFT	RIGHT	LEFT	RIGHT	LEFT		RIGHT
	STD DUTY	R	R.66045	R.66045	R.66045.1S	R.66045.2S	R.66045.1C	R.66045.2C	
04	EXT CAB (HYBRID ELECTRIC)	F	R.66040	R.66040	R.66040.1S	R.66040.2S	R.66040.1C	R.66040.2C	
		R	R.66041	R.66041	R.66041.1S	R.66041.2S	R.66041.1C	R.66041.2C	
04	EXT CAB (HD) 4.63" REAR HUB HOLE	F	R.66042	R.66042	R.66042.1S	R.66042.2S	R.66042.1C	R.66042.2C	
		R	R.66043	R.66043	R.66043.1S	R.66043.2S	R.66043.1C	R.66043.2C	
04	EXT CAB (HD) 4.83" REAR HUB HOLE	F	R.66042	R.66042	R.66042.1S	R.66042.2S	R.66042.1C	R.66042.2C	
		R	R.66044	R.66044	R.66044.1S	R.66044.2S	R.66044.1C	R.66044.2C	
05	REG, EXT, CREW CAB W/ REAR DRUM	F	R.66057	R.66057	R.66057.1S	R.66057.2S	R.66057.1C	R.66057.2C	
		R							
05	CREW CAB (HD)	F	R.66042	R.66042	R.66042.1S	R.66042.2S	R.66042.1C	R.66042.2C	
	W/O QUADRASTEER	R	R.66043	R.66043	R.66043.1S	R.66043.2S	R.66043.1C	R.66043.2C	
05	CREW CAB (HD)	F	R.66042	R.66042	R.66042.1S	R.66042.2S	R.66042.1C	R.66042.2C	
	W/ QUADRASTEER	R	R.66055	R.66055	R.66055.1S	R.66055.2S	R.66055.1C	R.66055.2C	
05	EXT CAB (HYBRID ELECTRIC)	F	R.66040	R.66040	R.66040.1S	R.66040.2S	R.66040.1C	R.66040.2C	
		R	R.66041	R.66041	R.66041.1S	R.66041.2S	R.66041.1C	R.66041.2C	
06	REG, EXT, CREW CAB W/ REAR DRUM	F	R.66057	R.66057	R.66057.1S	R.66057.2S	R.66057.1C	R.66057.2C	
		R							
06	REG, EXT CAB	F	R.66040	R.66040	R.66040.1S	R.66040.2S	R.66040.1C	R.66040.2C	
	W/ 6400, 7200 LBS. REAR AXLE	R	R.66041	R.66041	R.66041.1S	R.66041.2S	R.66041.1C	R.66041.2C	
06	EXT CAB (HYBRID ELECTRIC)	F	R.66040	R.66040	R.66040.1S	R.66040.2S	R.66040.1C	R.66040.2C	
		R	R.66041	R.66041	R.66041.1S	R.66041.2S	R.66041.1C	R.66041.2C	
06	CREW CAB (HD)	F	R.66042	R.66042	R.66042.1S	R.66042.2S	R.66042.1C	R.66042.2C	
		R	R.66043	R.66043	R.66043.1S	R.66043.2S	R.66043.1C	R.66043.2C	
06	EXT CAB (SS-6.0L V8)	F	R.66040	R.66040	R.66040.1S	R.66040.2S	R.66040.1C	R.66040.2C	
		R	R.66045	R.66045	R.66045.1S	R.66045.2S	R.66045.1C	R.66045.2C	
07	W/ REAR DRUM	F	R.66057	R.66057	R.66057.1S	R.66057.2S	R.66057.1C	R.66057.2C	
		R							
07	W/ REAR DISC	F	R.66057	R.66057	R.66057.1S	R.66057.2S	R.66057.1C	R.66057.2C	
		R	R.66065	R.66065	R.66065.1S	R.66065.2S	R.66065.1C	R.66065.2C	
<b>SIERRA 1500 (1/2 TON) 4WD</b>									
99-00		F	R.66040	R.66040	R.66040.1S	R.66040.2S	R.66040.1C	R.66040.2C	
		R	R.66041	R.66041	R.66041.1S	R.66041.2S	R.66041.1C	R.66041.2C	
01	2 DR	F	R.66040	R.66040	R.66040.1S	R.66040.2S	R.66040.1C	R.66040.2C	
		R	R.66041	R.66041	R.66041.1S	R.66041.2S	R.66041.1C	R.66041.2C	
01	EXT CAB (C3)	F	R.66040	R.66040	R.66040.1S	R.66040.2S	R.66040.1C	R.66040.2C	
		R	R.66045	R.66045	R.66045.1S	R.66045.2S	R.66045.1C	R.66045.2C	
01	4 DR (HD)	F	R.66042	R.66042	R.66042.1S	R.66042.2S	R.66042.1C	R.66042.2C	
		R	R.66043	R.66043	R.66043.1S	R.66043.2S	R.66043.1C	R.66043.2C	
02	REG CAB (2 WHEEL STEERING)	F	R.66040	R.66040	R.66040.1S	R.66040.2S	R.66040.1C	R.66040.2C	
		R	R.66041	R.66041	R.66041.1S	R.66041.2S	R.66041.1C	R.66041.2C	
02	EXT CAB (4 WHEEL STEERING)	F	R.66040	R.66040	R.66040.1S	R.66040.2S	R.66040.1C	R.66040.2C	
		R	R.66045	R.66045	R.66045.1S	R.66045.2S	R.66045.1C	R.66045.2C	
02	4 DR (HD)	F	R.66042	R.66042	R.66042.1S	R.66042.2S	R.66042.1C	R.66042.2C	
		R	R.66043	R.66043	R.66043.1S	R.66043.2S	R.66043.1C	R.66043.2C	
03	REG CAB (2 WHEEL STEERING)	F	R.66040	R.66040	R.66040.1S	R.66040.2S	R.66040.1C	R.66040.2C	
		R	R.66041	R.66041	R.66041.1S	R.66041.2S	R.66041.1C	R.66041.2C	
03	EXT CAB (2 WHEEL STEERING)	F	R.66040	R.66040	R.66040.1S	R.66040.2S	R.66040.1C	R.66040.2C	
		R	R.66041	R.66041	R.66041.1S	R.66041.2S	R.66041.1C	R.66041.2C	
03	EXT CAB (4 WHEEL STEERING) 330MM REAR DISC	F	R.66040	R.66040	R.66040.1S	R.66040.2S	R.66040.1C	R.66040.2C	
		R	R.66045	R.66045	R.66045.1S	R.66045.2S	R.66045.1C	R.66045.2C	
03	EXT CAB (4 WHEEL STEERING) 325MM REAR DISC	F	R.66040	R.66040	R.66040.1S	R.66040.2S	R.66040.1C	R.66040.2C	
		R	R.66041	R.66041	R.66041.1S	R.66041.2S	R.66041.1C	R.66041.2C	
03	4 DR (HD) 2 WHEEL STEERING	F	R.66042	R.66042	R.66042.1S	R.66042.2S	R.66042.1C	R.66042.2C	
		R	R.66043	R.66043	R.66043.1S	R.66043.2S	R.66043.1C	R.66043.2C	
03	4 DR (HD) 4 WHEEL STEERING	F	R.66042	R.66042	R.66042.1S	R.66042.2S	R.66042.1C	R.66042.2C	
		R	R.66041	R.66041	R.66041.1S	R.66041.2S	R.66041.1C	R.66041.2C	
04	REG CAB	F	R.66040	R.66040	R.66040.1S	R.66040.2S	R.66040.1C	R.66040.2C	
		R	R.66041	R.66041	R.66041.1S	R.66041.2S	R.66041.1C	R.66041.2C	
04	CREW CAB	F	R.66040	R.66040	R.66040.1S	R.66040.2S	R.66040.1C	R.66040.2C	
		R	R.66045	R.66045	R.66045.1S	R.66045.2S	R.66045.1C	R.66045.2C	
04	EXT CAB (2 WHEEL STEERING) STD DUTY	F	R.66040	R.66040	R.66040.1S	R.66040.2S	R.66040.1C	R.66040.2C	
		R	R.66041	R.66041	R.66041.1S	R.66041.2S	R.66041.1C	R.66041.2C	
04	EXT CAB (4 WHEEL STEERING) STD DUTY	F	R.66040	R.66040	R.66040.1S	R.66040.2S	R.66040.1C	R.66040.2C	
		R	R.66045	R.66045	R.66045.1S	R.66045.2S	R.66045.1C	R.66045.2C	
04	EXT CAB (HYBRID ELECTRIC)	F	R.66040	R.66040	R.66040.1S	R.66040.2S	R.66040.1C	R.66040.2C	
		R	R.66041	R.66041	R.66041.1S	R.66041.2S	R.66041.1C	R.66041.2C	
04	EXT CAB (HD) 4.63" REAR HUB HOLE	F	R.66042	R.66042	R.66042.1S	R.66042.2S	R.66042.1C	R.66042.2C	
		R	R.66043	R.66043	R.66043.1S	R.66043.2S	R.66043.1C	R.66043.2C	

BRAKE DISC		BASIC OEM		SLOTTED		DRILLED & SLOTTED		NOTES
		AXLE	PART #		PART #		PART #	
MAKE/MODEL	YEAR	F/R	LEFT	RIGHT	LEFT	RIGHT	LEFT	RIGHT
04	EXT CAB (HD) 4.83" REAR HUB HOLE	F	R.66042	R.66042	R.66042.1S	R.66042.2S	R.66042.1C	R.66042.2C
		R	R.66044	R.66044	R.66044.1S	R.66044.2S	R.66044.1C	R.66044.2C
05	REG, EXT, CREW CAB W/ REAR DRUM	F	R.66057	R.66057	R.66057.1S	R.66057.2S	R.66057.1C	R.66057.2C
		R						
05	CREW CAB (HD) W/O QUADRASTEER	F	R.66042	R.66042	R.66042.1S	R.66042.2S	R.66042.1C	R.66042.2C
		R	R.66043	R.66043	R.66043.1S	R.66043.2S	R.66043.1C	R.66043.2C
05	CREW CAB (HD) W/ QUADRASTEER	F	R.66042	R.66042	R.66042.1S	R.66042.2S	R.66042.1C	R.66042.2C
		R	R.66055	R.66055	R.66055.1S	R.66055.2S	R.66055.1C	R.66055.2C
05	EXT CAB (HYBRID ELECTRIC)	F	R.66040	R.66040	R.66040.1S	R.66040.2S	R.66040.1C	R.66040.2C
		R	R.66041	R.66041	R.66041.1S	R.66041.2S	R.66041.1C	R.66041.2C
06	REG, EXT, CREW CAB W/ REAR DRUM	F	R.66057	R.66057	R.66057.1S	R.66057.2S	R.66057.1C	R.66057.2C
		R						
06	REG, EXT CAB W/ 6400, 7200 LBS. REAR AXLE	F	R.66040	R.66040	R.66040.1S	R.66040.2S	R.66040.1C	R.66040.2C
		R	R.66041	R.66041	R.66041.1S	R.66041.2S	R.66041.1C	R.66041.2C
06	EXT CAB (HYBRID ELECTRIC)	F	R.66040	R.66040	R.66040.1S	R.66040.2S	R.66040.1C	R.66040.2C
		R	R.66041	R.66041	R.66041.1S	R.66041.2S	R.66041.1C	R.66041.2C
06	CREW CAB (HD)	F	R.66042	R.66042	R.66042.1S	R.66042.2S	R.66042.1C	R.66042.2C
		R	R.66043	R.66043	R.66043.1S	R.66043.2S	R.66043.1C	R.66043.2C
06	EXT CAB (SS-6.0L V8)	F	R.66040	R.66040	R.66040.1S	R.66040.2S	R.66040.1C	R.66040.2C
		R	R.66045	R.66045	R.66045.1S	R.66045.2S	R.66045.1C	R.66045.2C
07	W/ REAR DRUM	F	R.66057	R.66057	R.66057.1S	R.66057.2S	R.66057.1C	R.66057.2C
		R						
07	W/ REAR DISC	F	R.66057	R.66057	R.66057.1S	R.66057.2S	R.66057.1C	R.66057.2C
		R	R.66065	R.66065	R.66065.1S	R.66065.2S	R.66065.1C	R.66065.2C
<b>SIERRA 2500 (3/4 TON) 2WD &amp; 4WD</b>								
99-00	EXC HD (A/T)	F	R.66042	R.66042	R.66042.1S	R.66042.2S	R.66042.1C	R.66042.2C
		R	R.66043	R.66043	R.66043.1S	R.66043.2S	R.66043.1C	R.66043.2C
99-00	EXC HD (M/T)	F	R.66042	R.66042	R.66042.1S	R.66042.2S	R.66042.1C	R.66042.2C
		R	R.66044	R.66044	R.66044.1S	R.66044.2S	R.66044.1C	R.66044.2C
01-03	EXC HD (A/T)	F	R.66042	R.66042	R.66042.1S	R.66042.2S	R.66042.1C	R.66042.2C
		R	R.66043	R.66043	R.66043.1S	R.66043.2S	R.66043.1C	R.66043.2C
01-03	EXC HD (M/T)	F	R.66042	R.66042	R.66042.1S	R.66042.2S	R.66042.1C	R.66042.2C
		R	R.66044	R.66044	R.66044.1S	R.66044.2S	R.66044.1C	R.66044.2C
01-03	HD	F	R.66059	R.66059	R.66059.1S	R.66059.2S	R.66059.1C	R.66059.2C
		R	R.66044	R.66044	R.66044.1S	R.66044.2S	R.66044.1C	R.66044.2C
04	EXC HD (A/T)	F	R.66042	R.66042	R.66042.1S	R.66042.2S	R.66042.1C	R.66042.2C
		R	R.66043	R.66043	R.66043.1S	R.66043.2S	R.66043.1C	R.66043.2C
04	EXC HD (M/T)	F	R.66042	R.66042	R.66042.1S	R.66042.2S	R.66042.1C	R.66042.2C
		R	R.66044	R.66044	R.66044.1S	R.66044.2S	R.66044.1C	R.66044.2C
04	HD (2 WHEEL STEERING)	F	R.66059	R.66059	R.66059.1S	R.66059.2S	R.66059.1C	R.66059.2C
		R	R.66044	R.66044	R.66044.1S	R.66044.2S	R.66044.1C	R.66044.2C
04	HD (4 WHEEL STEERING)	F	R.66059	R.66059	R.66059.1S	R.66059.2S	R.66059.1C	R.66059.2C
		R	R.66055	R.66055	R.66055.1S	R.66055.2S	R.66055.1C	R.66055.2C
05	EXC HD	F	R.66042	R.66042	R.66042.1S	R.66042.2S	R.66042.1C	R.66042.2C
		R	R.66044	R.66044	R.66044.1S	R.66044.2S	R.66044.1C	R.66044.2C
05	HD	F	R.66059	R.66059	R.66059.1S	R.66059.2S	R.66059.1C	R.66059.2C
		R	R.66044	R.66044	R.66044.1S	R.66044.2S	R.66044.1C	R.66044.2C
06-07		F	R.66059	R.66059	R.66059.1S	R.66059.2S	R.66059.1C	R.66059.2C
		R	R.66044	R.66044	R.66044.1S	R.66044.2S	R.66044.1C	R.66044.2C
<b>SIERRA 3500 (1 TON) 2WD</b>								
01-05		F	R.66059	R.66059	R.66059.1S	R.66059.2S	R.66059.1C	R.66059.2C
		R	R.66050	R.66050	R.66050.1S	R.66050.2S	R.66050.1C	R.66050.2C
06-07	SRW	F	R.66059	R.66059	R.66059.1S	R.66059.2S	R.66059.1C	R.66059.2C
		R	R.66044	R.66044	R.66044.1S	R.66044.2S	R.66044.1C	R.66044.2C
06-07	DRW	F	R.66059	R.66059	R.66059.1S	R.66059.2S	R.66059.1C	R.66059.2C
		R	R.66050	R.66050	R.66050.1S	R.66050.2S	R.66050.1C	R.66050.2C
<b>SIERRA 3500 (1 TON) 4WD</b>								
01-03		F	R.66059	R.66059	R.66059.1S	R.66059.2S	R.66059.1C	R.66059.2C
		R	R.66050	R.66050	R.66050.1S	R.66050.2S	R.66050.1C	R.66050.2C
04-06	SRW	F	R.66059	R.66059	R.66059.1S	R.66059.2S	R.66059.1C	R.66059.2C
		R	R.66044	R.66044	R.66044.1S	R.66044.2S	R.66044.1C	R.66044.2C
04-06	DRW	F	R.66059	R.66059	R.66059.1S	R.66059.2S	R.66059.1C	R.66059.2C
		R	R.66050	R.66050	R.66050.1S	R.66050.2S	R.66050.1C	R.66050.2C
<b>SONOMA PICKUP 2WD</b>								
91-95	W/O 4 WHEEL ABS	F	R.62013	R.62013	R.62013.1S	R.62013.2S	R.62013.1C	R.62013.2C
		R						
91-95	W/ 4 WHEEL ABS	F	R.66017	R.66017	R.66017.1S	R.66017.2S	R.66017.1C	R.66017.2C
		R						

BRAKE DISC		BASIC OEM		SLOTTED		DRILLED & SLOTTED		NOTES
		AXLE	PART #		PART #		PART #	
MAKE/MODEL	YEAR	F/R	LEFT	RIGHT	LEFT	RIGHT	LEFT	RIGHT
96-03		F R	R.66017	R.66017	R.66017.1S	R.66017.2S	R.66017.1C	R.66017.2C
04		F R	R.66038 R.66039	R.66038 R.66039	R.66038.1S R.66039.1S	R.66038.2S R.66039.2S	R.66038.1C R.66039.1C	R.66038.2C R.66039.2C
<b>SONOMA PICKUP 4WD</b>								
91-97		F R	R.66006	R.66006	R.66006.1S	R.66006.2S	R.66006.1C	R.66006.2C
98-04	2.2L ENG	F R	R.66038 R.66036	R.66038 R.66036	R.66038.1S R.66036.1S	R.66038.2S R.66036.2S	R.66038.1C R.66036.1C	R.66038.2C R.66036.2C
04	4.3L ENG	F R	R.66038 R.66039	R.66038 R.66039	R.66038.1S R.66039.1S	R.66038.2S R.66039.2S	R.66038.1C R.66039.1C	R.66038.2C R.66039.2C
<b>SUBURBAN 1500 (1/2 TON) 2WD</b>								
92-00	11" REAR DRUM BRAKE (5 LUG)	F R	R.66025	R.66025	R.66025.1S	R.66025.2S	R.66025.1C	R.66025.2C
94-00	13" REAR DRUM BRAKE (8 LUG)	F R	R.66027	R.66027	R.66027.1S	R.66027.2S	R.66027.1C	R.66027.2C
<b>SUBURBAN 1500 (1/2 TON) 4WD</b>								
92-00	11" REAR DRUM BRAKE (6 LUG)	F R	R.66009	R.66009	R.66009.1S	R.66009.2S	R.66009.1C	R.66009.2C
94-00	13" REAR DRUM BRAKE (8 LUG)	F R	R.62042	R.62042	R.62042.1S	R.62042.2S	R.62042.1C	R.62042.2C
<b>SUBURBAN 2500 (3/4 TON) 2WD</b>								
92-00		F R	R.66027	R.66027	R.66027.1S	R.66027.2S	R.66027.1C	R.66027.2C
<b>SUBURBAN 2500 (3/4 TON) 4WD</b>								
92-00		F R	R.62042	R.62042	R.62042.1S	R.62042.2S	R.62042.1C	R.62042.2C
<b>YUKON, DENALI 2WD (EXC XL)</b>								
95-99		F R	R.66025	R.66025	R.66025.1S	R.66025.2S	R.66025.1C	R.66025.2C
00	W/ REAR DRUM	F R	R.66025	R.66025	R.66025.1S	R.66025.2S	R.66025.1C	R.66025.2C
00	W/ REAR DISC	F R	R.66040 R.66045	R.66040 R.66045	R.66040.1S R.66045.1S	R.66040.2S R.66045.2S	R.66040.1C R.66045.1C	R.66040.2C R.66045.2C
01-06	W/ REAR DISC	F R	R.66040 R.66045	R.66040 R.66045	R.66040.1S R.66045.1S	R.66040.2S R.66045.2S	R.66040.1C R.66045.1C	R.66040.2C R.66045.2C
07		F R	R.66057 R.66065	R.66057 R.66065	R.66057.1S R.66065.1S	R.66057.2S R.66065.2S	R.66057.1C R.66065.1C	R.66057.2C R.66065.2C
<b>YUKON, DENALI 4WD (EXC XL)</b>								
92-99		F R	R.66009	R.66009	R.66009.1S	R.66009.2S	R.66009.1C	R.66009.2C
00	W/ REAR DRUM	F R	R.66009	R.66009	R.66009.1S	R.66009.2S	R.66009.1C	R.66009.2C
00	W/ LIMITED SLIP AXLE	F R	R.66040 R.66045	R.66040 R.66045	R.66040.1S R.66045.1S	R.66040.2S R.66045.2S	R.66040.1C R.66045.1C	R.66040.2C R.66045.2C
00	W/O LIMITED SLIP AXLE	F R	R.66040 R.66041	R.66040 R.66041	R.66040.1S R.66041.1S	R.66040.2S R.66041.2S	R.66040.1C R.66041.1C	R.66040.2C R.66041.2C
01-02	W/ LIMITED SLIP AXLE	F R	R.66040 R.66045	R.66040 R.66045	R.66040.1S R.66045.1S	R.66040.2S R.66045.2S	R.66040.1C R.66045.1C	R.66040.2C R.66045.2C
01-02	W/O LIMITED SLIP AXLE	F R	R.66040 R.66041	R.66040 R.66041	R.66040.1S R.66041.1S	R.66040.2S R.66041.2S	R.66040.1C R.66041.1C	R.66040.2C R.66041.2C
03-06		F R	R.66040 R.66045	R.66040 R.66045	R.66040.1S R.66045.1S	R.66040.2S R.66045.2S	R.66040.1C R.66045.1C	R.66040.2C R.66045.2C
07		F R	R.66057 R.66065	R.66057 R.66065	R.66057.1S R.66065.1S	R.66057.2S R.66065.2S	R.66057.1C R.66065.1C	R.66057.2C R.66065.2C
<b>YUKON, DENALI XL (1/2 TON)</b>								
00-02	2WD, 4WD (W/ LIMITED SLIP AXLE)	F R	R.66040 R.66045	R.66040 R.66045	R.66040.1S R.66045.1S	R.66040.2S R.66045.2S	R.66040.1C R.66045.1C	R.66040.2C R.66045.2C
00-02	2WD, 4WD (W/O LIMITED SLIP AXLE)	F R	R.66040 R.66041	R.66040 R.66041	R.66040.1S R.66041.1S	R.66040.2S R.66041.2S	R.66040.1C R.66041.1C	R.66040.2C R.66041.2C
03-06	2WD, 4WD	F R	R.66040 R.66045	R.66040 R.66045	R.66040.1S R.66045.1S	R.66040.2S R.66045.2S	R.66040.1C R.66045.1C	R.66040.2C R.66045.2C
07		F R	R.66057 R.66065	R.66057 R.66065	R.66057.1S R.66065.1S	R.66057.2S R.66065.2S	R.66057.1C R.66065.1C	R.66057.2C R.66065.2C
<b>YUKON, DENALI XL (3/4 TON)</b>								
00-02	4.63" REAR HUB HOLE	F R	R.66042 R.66043	R.66042 R.66043	R.66042.1S R.66043.1S	R.66042.2S R.66043.2S	R.66042.1C R.66043.1C	R.66042.2C R.66043.2C
00-02	4.83" REAR HUB HOLE	F	R.66042	R.66042	R.66042.1S	R.66042.2S	R.66042.1C	R.66042.2C



BRAKE DISC		BASIC OEM		SLOTTED		DRILLED & SLOTTED		NOTES	
		MAKE/MODEL	AXLE	PART #		PART #			PART #
YEAR		F/R	LEFT	RIGHT	LEFT	RIGHT	LEFT	RIGHT	
		R	R.66044	R.66044	R.66044.1S	R.66044.2S	R.66044.1C	R.66044.2C	
03	2 WHEEL STEERING	F	R.66042	R.66042	R.66042.1S	R.66042.2S	R.66042.1C	R.66042.2C	
	4.63" REAR HUB HOLE	R	R.66043	R.66043	R.66043.1S	R.66043.2S	R.66043.1C	R.66043.2C	
03	2 WHEEL STEERING	F	R.66042	R.66042	R.66042.1S	R.66042.2S	R.66042.1C	R.66042.2C	
	4.83" REAR HUB HOLE	R	R.66044	R.66044	R.66044.1S	R.66044.2S	R.66044.1C	R.66044.2C	
03	4 WHEEL STEERING	F	R.66042	R.66042	R.66042.1S	R.66042.2S	R.66042.1C	R.66042.2C	
		R	R.66041	R.66041	R.66041.1S	R.66041.2S	R.66041.1C	R.66041.2C	
04-05	2 WHEEL STEERING	F	R.66042	R.66042	R.66042.1S	R.66042.2S	R.66042.1C	R.66042.2C	
	4.63" REAR HUB HOLE	R	R.66043	R.66043	R.66043.1S	R.66043.2S	R.66043.1C	R.66043.2C	
04-05	2 WHEEL STEERING	F	R.66042	R.66042	R.66042.1S	R.66042.2S	R.66042.1C	R.66042.2C	
	4.83" REAR HUB HOLE	R	R.66044	R.66044	R.66044.1S	R.66044.2S	R.66044.1C	R.66044.2C	
04-05	4 WHEEL STEERING	F	R.66042	R.66042	R.66042.1S	R.66042.2S	R.66042.1C	R.66042.2C	
		R	R.66055	R.66055	R.66055.1S	R.66055.2S	R.66055.1C	R.66055.2C	
06	4.63" REAR HUB HOLE	F	R.66042	R.66042	R.66042.1S	R.66042.2S	R.66042.1C	R.66042.2C	
		R	R.66043	R.66043	R.66043.1S	R.66043.2S	R.66043.1C	R.66043.2C	
06	4.83" REAR HUB HOLE	F	R.66042	R.66042	R.66042.1S	R.66042.2S	R.66042.1C	R.66042.2C	
		R	R.66044	R.66044	R.66044.1S	R.66044.2S	R.66044.1C	R.66044.2C	
07		F	R.66042	R.66042	R.66042.1S	R.66042.2S	R.66042.1C	R.66042.2C	
		R	R.66043	R.66043	R.66043.1S	R.66043.2S	R.66043.1C	R.66043.2C	
<b>HONDA</b>									
<b>ACCORD COUPE</b>									
90-97	W/ REAR DRUM	F	R.40022	R.40022	R.40022.1S	R.40022.2S	R.40022.1C	R.40022.2C	
		R							
90-97	W/ REAR DISC	F	R.40022	R.40022	R.40022.1S	R.40022.2S	R.40022.1C	R.40022.2C	
		R	R.40024	R.40024	R.40024.1S	R.40024.2S	R.40024.1C	R.40024.2C	
98-02	4 CYL. (W/ REAR DRUM)	F	R.40039	R.40039	R.40039.1S	R.40039.2S	R.40039.1C	R.40039.2C	
		R							
98-02	4 CYL. (W/ REAR DISC)	F	R.40039	R.40039	R.40039.1S	R.40039.2S	R.40039.1C	R.40039.2C	
		R	R.40041	R.40041	R.40041.1S	R.40041.2S	R.40041.1C	R.40041.2C	
98-02	V6	F	R.40036	R.40036	R.40036.1S	R.40036.2S	R.40036.1C	R.40036.2C	
		R	R.40042	R.40042	R.40042.1S	R.40042.2S	R.40042.1C	R.40042.2C	
03-06	4 CYL. (LX)	F	R.40036	R.40036	R.40036.1S	R.40036.2S	R.40036.1C	R.40036.2C	
	W/ REAR DRUM	R							
03-06	4 CYL. (EX)	F	R.40036	R.40036	R.40036.1S	R.40036.2S	R.40036.1C	R.40036.2C	
	EX W/ REAR DISC	R	R.40055	R.40055	R.40055.1S	R.40055.2S	R.40055.1C	R.40055.2C	
03-07	V6-EX (6 SPEED M/T)	F	R.40046	R.40046	R.40046.1S	R.40046.2S	R.40046.1C	R.40046.2C	
		R	R.40055	R.40055	R.40055.1S	R.40055.2S	R.40055.1C	R.40055.2C	
03-07	V6-LX, EX (AT)	F	R.40036	R.40036	R.40036.1S	R.40036.2S	R.40036.1C	R.40036.2C	
		R	R.40055	R.40055	R.40055.1S	R.40055.2S	R.40055.1C	R.40055.2C	
<b>ACCORD SEDAN</b>									
90-94	W/ REAR DRUM	F	R.40022	R.40022	R.40022.1S	R.40022.2S	R.40022.1C	R.40022.2C	
		R							
90-94	W/ REAR DISC	F	R.40022	R.40022	R.40022.1S	R.40022.2S	R.40022.1C	R.40022.2C	
		R	R.40024	R.40024	R.40024.1S	R.40024.2S	R.40024.1C	R.40024.2C	
95	V6 (W/ REAR DRUM)	F	R.40025	R.40025	R.40025.1S	R.40025.2S	R.40025.1C	R.40025.2C	
		R							
95-97	4 CYL. (W/ REAR DRUM)	F	R.40022	R.40022	R.40022.1S	R.40022.2S	R.40022.1C	R.40022.2C	
		R							
95-97	4 CYL. (W/ REAR DISC)	F	R.40022	R.40022	R.40022.1S	R.40022.2S	R.40022.1C	R.40022.2C	
		R	R.40024	R.40024	R.40024.1S	R.40024.2S	R.40024.1C	R.40024.2C	
95-97	V6 (W/ REAR DISC)	F	R.40025	R.40025	R.40025.1S	R.40025.2S	R.40025.1C	R.40025.2C	
		R	R.40024	R.40024	R.40024.1S	R.40024.2S	R.40024.1C	R.40024.2C	
98-02	4 CYL. (W/ REAR DRUM)	F	R.40039	R.40039	R.40039.1S	R.40039.2S	R.40039.1C	R.40039.2C	
		R							
98-02	4 CYL. (W/ REAR DISC)	F	R.40039	R.40039	R.40039.1S	R.40039.2S	R.40039.1C	R.40039.2C	
		R	R.40041	R.40041	R.40041.1S	R.40041.2S	R.40041.1C	R.40041.2C	
98-02	V6	F	R.40036	R.40036	R.40036.1S	R.40036.2S	R.40036.1C	R.40036.2C	
		R	R.40042	R.40042	R.40042.1S	R.40042.2S	R.40042.1C	R.40042.2C	
03-04	4 CYL. (W/ REAR DRUM)	F	R.40036	R.40036	R.40036.1S	R.40036.2S	R.40036.1C	R.40036.2C	
		R							
03-04	4 CYL. (W/ REAR DISC)	F	R.40036	R.40036	R.40036.1S	R.40036.2S	R.40036.1C	R.40036.2C	
		R	R.40055	R.40055	R.40055.1S	R.40055.2S	R.40055.1C	R.40055.2C	
03-04	V6	F	R.40036	R.40036	R.40036.1S	R.40036.2S	R.40036.1C	R.40036.2C	
		R	R.40055	R.40055	R.40055.1S	R.40055.2S	R.40055.1C	R.40055.2C	
05	4 CYL. (W/ REAR DRUM)	F	R.40036	R.40036	R.40036.1S	R.40036.2S	R.40036.1C	R.40036.2C	
		R							
05	4 CYL. (W/ REAR DISC)	F	R.40036	R.40036	R.40036.1S	R.40036.2S	R.40036.1C	R.40036.2C	

BRAKE DISC		BASIC OEM		SLOTTED		DRILLED & SLOTTED		NOTES	
MAKE/MODEL		AXLE	PART #		PART #		PART #		
YEAR		F/R	LEFT	RIGHT	LEFT	RIGHT	LEFT		RIGHT
05	V6 (EXC HYBRID)	R	R.40055	R.40055	R.40055.1S	R.40055.2S	R.40055.1C	R.40055.2C	
		F	R.40036	R.40036	R.40036.1S	R.40036.2S	R.40036.1C	R.40036.2C	
05	V6 (HYBRID)	R	R.40055	R.40055	R.40055.1S	R.40055.2S	R.40055.1C	R.40055.2C	
		F	R.40036	R.40036	R.40036.1S	R.40036.2S	R.40036.1C	R.40036.2C	
06-07	4 CYL. (W/ REAR DRUM)	R	R.40068	R.40068	R.40068.1S	R.40068.2S	R.40068.1C	R.40068.2C	
		F	R.40036	R.40036	R.40036.1S	R.40036.2S	R.40036.1C	R.40036.2C	
06-07	4 CYL. (W/ REAR DISC)	R	R.40055	R.40055	R.40055.1S	R.40055.2S	R.40055.1C	R.40055.2C	
		F	R.40036	R.40036	R.40036.1S	R.40036.2S	R.40036.1C	R.40036.2C	
06-07	V6 (HYBRID)	R	R.40046	R.40046	R.40046.1S	R.40046.2S	R.40046.1C	R.40046.2C	
		F	R.40068	R.40068	R.40068.1S	R.40068.2S	R.40068.1C	R.40068.2C	
06-07	V6 (EXC HYBRID)	R	R.40055	R.40055	R.40055.1S	R.40055.2S	R.40055.1C	R.40055.2C	
		F	R.40036	R.40036	R.40036.1S	R.40036.2S	R.40036.1C	R.40036.2C	
<b>CIVIC COUPE</b>									
93-95	DX 1500	R	R.40023	R.40023	R.40023.1S	R.40023.2S	R.40023.1C	R.40023.2C	
		F	R.40021	R.40021	R.40021.1S	R.40021.2S	R.40021.1C	R.40021.2C	
93-95	EX 1600 (W/O ABS)	R	R.40021	R.40021	R.40021.1S	R.40021.2S	R.40021.1C	R.40021.2C	
		F	R.40017	R.40017	R.40017.1S	R.40017.2S	R.40017.1C	R.40017.2C	
93-95	EX 1600 (W/ ABS)	R	R.40023	R.40023	R.40023.1S	R.40023.2S	R.40023.1C	R.40023.2C	
		F	R.40021	R.40021	R.40021.1S	R.40021.2S	R.40021.1C	R.40021.2C	
96-00	DX, HX	R	R.40021	R.40021	R.40021.1S	R.40021.2S	R.40021.1C	R.40021.2C	
		F	R.40017	R.40017	R.40017.1S	R.40017.2S	R.40017.1C	R.40017.2C	
96-00	EX	R	R.40056	R.40056	R.40056.1S	R.40056.2S	R.40056.1C	R.40056.2C	
		F	R.40040	R.40040	R.40040.1S	R.40040.2S	R.40040.1C	R.40040.2C	
99-00	Si	R	R.40057	R.40057	R.40057.1S	R.40057.2S	R.40057.1C	R.40057.2C	
		F	R.40040	R.40040	R.40040.1S	R.40040.2S	R.40040.1C	R.40040.2C	
01-05	ALL MODEL	R	R.40021	R.40021	R.40021.1S	R.40021.2S	R.40021.1C	R.40021.2C	
		F	R.40017	R.40017	R.40017.1S	R.40017.2S	R.40017.1C	R.40017.2C	
06-07	DX, LX (1.8L)	R	R.40023	R.40023	R.40023.1S	R.40023.2S	R.40023.1C	R.40023.2C	
		F	R.40021	R.40021	R.40021.1S	R.40021.2S	R.40021.1C	R.40021.2C	
06-07	EX (1.8L)	R	R.40056	R.40056	R.40056.1S	R.40056.2S	R.40056.1C	R.40056.2C	
		F	R.40040	R.40040	R.40040.1S	R.40040.2S	R.40040.1C	R.40040.2C	
06-07	Si	R	R.40057	R.40057	R.40057.1S	R.40057.2S	R.40057.1C	R.40057.2C	
		F	R.40040	R.40040	R.40040.1S	R.40040.2S	R.40040.1C	R.40040.2C	
<b>CIVIC HATCHBACK</b>									
90-91	1500 CX, DX, VX	R	R.40023	R.40023	R.40023.1S	R.40023.2S	R.40023.1C	R.40023.2C	
		F	R.40021	R.40021	R.40021.1S	R.40021.2S	R.40021.1C	R.40021.2C	
92-93	1600 Si	R	R.40023	R.40023	R.40023.1S	R.40023.2S	R.40023.1C	R.40023.2C	
		F	R.40017	R.40017	R.40017.1S	R.40017.2S	R.40017.1C	R.40017.2C	
94-95	1500 CX, DX, VX	R	R.40023	R.40023	R.40023.1S	R.40023.2S	R.40023.1C	R.40023.2C	
		F	R.40021	R.40021	R.40021.1S	R.40021.2S	R.40021.1C	R.40021.2C	
94-95	1600 Si (W/O ABS)	R	R.40023	R.40023	R.40023.1S	R.40023.2S	R.40023.1C	R.40023.2C	
		F	R.40017	R.40017	R.40017.1S	R.40017.2S	R.40017.1C	R.40017.2C	
94-95	1600 Si (W/ ABS)	R	R.40021	R.40021	R.40021.1S	R.40021.2S	R.40021.1C	R.40021.2C	
		F	R.40017	R.40017	R.40017.1S	R.40017.2S	R.40017.1C	R.40017.2C	
96-00	Si	R	R.40023	R.40023	R.40023.1S	R.40023.2S	R.40023.1C	R.40023.2C	
		F	R.40021	R.40021	R.40021.1S	R.40021.2S	R.40021.1C	R.40021.2C	
02-03	Si	R	R.40060	R.40060	R.40060.1S	R.40060.2S	R.40060.1C	R.40060.2C	
		F	R.40056	R.40056	R.40056.1S	R.40056.2S	R.40056.1C	R.40056.2C	
04-05	Si	R	R.40042	R.40042	R.40042.1S	R.40042.2S	R.40042.1C	R.40042.2C	
		F	R.40040	R.40040	R.40040.1S	R.40040.2S	R.40040.1C	R.40040.2C	
<b>CIVIC SEDAN</b>									
90-91	1500 DX, LX	R	R.40023	R.40023	R.40023.1S	R.40023.2S	R.40023.1C	R.40023.2C	
		F	R.40021	R.40021	R.40021.1S	R.40021.2S	R.40021.1C	R.40021.2C	
90-91	EX 1600	R	R.40023	R.40023	R.40023.1S	R.40023.2S	R.40023.1C	R.40023.2C	
		F	R.40021	R.40021	R.40021.1S	R.40021.2S	R.40021.1C	R.40021.2C	
92-93	DX, LX	R	R.40021	R.40021	R.40021.1S	R.40021.2S	R.40021.1C	R.40021.2C	
		F	R.40017	R.40017	R.40017.1S	R.40017.2S	R.40017.1C	R.40017.2C	
92-93	EX	R	R.40023	R.40023	R.40023.1S	R.40023.2S	R.40023.1C	R.40023.2C	
		F	R.40021	R.40021	R.40021.1S	R.40021.2S	R.40021.1C	R.40021.2C	
94-95	DX, LX	R	R.40023	R.40023	R.40023.1S	R.40023.2S	R.40023.1C	R.40023.2C	
		F	R.40021	R.40021	R.40021.1S	R.40021.2S	R.40021.1C	R.40021.2C	
94-95	EX, LX (W/ ABS)	R	R.40023	R.40023	R.40023.1S	R.40023.2S	R.40023.1C	R.40023.2C	
		F	R.40017	R.40017	R.40017.1S	R.40017.2S	R.40017.1C	R.40017.2C	
96	DX, LX	R	R.40023	R.40023	R.40023.1S	R.40023.2S	R.40023.1C	R.40023.2C	
		F	R.40021	R.40021	R.40021.1S	R.40021.2S	R.40021.1C	R.40021.2C	

BRAKE DISC		BASIC OEM		SLOTTED		DRILLED & SLOTTED		NOTES	
MAKE/MODEL	AXLE	PART #		PART #		PART #			
YEAR	F/R	LEFT	RIGHT	LEFT	RIGHT	LEFT	RIGHT		
96	EX, LX (W/ ABS)	F	R.40021	R.40021	R.40021.1S	R.40021.2S	R.40021.1C	R.40021.2C	
		R							
97-00	DX, LX	F	R.40023	R.40023	R.40023.1S	R.40023.2S	R.40023.1C	R.40023.2C	
		R							
97-00	EX	F	R.40021	R.40021	R.40021.1S	R.40021.2S	R.40021.1C	R.40021.2C	
		R							
97-00	GX	F	R.40023	R.40023	R.40023.1S	R.40023.2S	R.40023.1C	R.40023.2C	
		R							
01-05	ALL MODEL	F	R.40021	R.40021	R.40021.1S	R.40021.2S	R.40021.1C	R.40021.2C	
		R							
06-07	DX, LX W/ REAR DRUM	F	R.40056	R.40056	R.40056.1S	R.40056.2S	R.40056.1C	R.40056.2C	
		R							
06-07	EX W/ REAR DISC	F	R.40056	R.40056	R.40056.1S	R.40056.2S	R.40056.1C	R.40056.2C	
		R	R.40040	R.40040	R.40040.1S	R.40040.2S	R.40040.1C	R.40040.2C	
06-07	GX W/ REAR DRUM	F	R.40036	R.40036	R.40036.1S	R.40036.2S	R.40036.1C	R.40036.2C	
		R							
06-07	HYBRID W/ REAR DRUM	F	R.40056	R.40056	R.40056.1S	R.40056.2S	R.40056.1C	R.40056.2C	
		R							
07	SI W/ REAR DISC	F	R.40057	R.40057	R.40057.1S	R.40057.2S	R.40057.1C	R.40057.2C	
		R	R.40040	R.40040	R.40040.1S	R.40040.2S	R.40040.1C	R.40040.2C	
<b>CIVIC DEL SOL</b>									
93-97	S	F	R.40023	R.40023	R.40023.1S	R.40023.2S	R.40023.1C	R.40023.2C	
		R							
93-97	SI (W/O ABS)	F	R.40023	R.40023	R.40023.1S	R.40023.2S	R.40023.1C	R.40023.2C	
		R	R.40017	R.40017	R.40017.1S	R.40017.2S	R.40017.1C	R.40017.2C	
93-97	V-TEC (W/ ABS)	F	R.40021	R.40021	R.40021.1S	R.40021.2S	R.40021.1C	R.40021.2C	
		R	R.40017	R.40017	R.40017.1S	R.40017.2S	R.40017.1C	R.40017.2C	
<b>CR-V</b>									
97-01		F	R.40026	R.40026	R.40026.1S	R.40026.2S	R.40026.1C	R.40026.2C	
		R							
02-04		F	R.40036	R.40036	R.40036.1S	R.40036.2S	R.40036.1C	R.40036.2C	
		R	R.40058	R.40058	R.40058.1S	R.40058.2S	R.40058.1C	R.40058.2C	
05-06		F	R.40057	R.40057	R.40057.1S	R.40057.2S	R.40057.1C	R.40057.2C	
		R	R.40063	R.40063	R.40063.1S	R.40063.2S	R.40063.1C	R.40063.2C	
07		F	R.40073	R.40073	R.40073.1S	R.40073.2S	R.40073.1C	R.40073.2C	c
		R	R.40063	R.40063	R.40063.1S	R.40063.2S	R.40063.1C	R.40063.2C	
<b>CRX</b>									
90-91	DX 1.5L	F	R.40023	R.40023	R.40023.1S	R.40023.2S	R.40023.1C	R.40023.2C	
		R							
90-91	HF 1.5L	F	R.40005	R.40005	R.40005.1S	R.40005.2S	R.40005.1C	R.40005.2C	
		R							
90-91	Si 1.6L	F	R.40013	R.40013	R.40013.1S	R.40013.2S	R.40013.1C	R.40013.2C	
		R	R.40017	R.40017	R.40017.1S	R.40017.2S	R.40017.1C	R.40017.2C	
<b>ELEMENT</b>									
03-07		F	R.40036	R.40036	R.40036.1S	R.40036.2S	R.40036.1C	R.40036.2C	
		R	R.40061	R.40061	R.40061.1S	R.40061.2S	R.40061.1C	R.40061.2C	
<b>FIT</b>									
07		F	R.40021	R.40021	R.40021.1S	R.40021.2S	R.40021.1C	R.40021.2C	
		R							
<b>ODYSSEY</b>									
95-98		F	R.40026	R.40026	R.40026.1S	R.40026.2S	R.40026.1C	R.40026.2C	
		R	R.40027	R.40027	R.40027.1S	R.40027.2S	R.40027.1C	R.40027.2C	
99-01		F	R.40046	R.40046	R.40046.1S	R.40046.2S	R.40046.1C	R.40046.2C	
		R							
02-04		F	R.40046	R.40046	R.40046.1S	R.40046.2S	R.40046.1C	R.40046.2C	
		R	R.40059	R.40059	R.40059.1S	R.40059.2S	R.40059.1C	R.40059.2C	
05-07		F	R.40064	R.40064	R.40064.1S	R.40064.2S	R.40064.1C	R.40064.2C	
		R	R.40065	R.40065	R.40065.1S	R.40065.2S	R.40065.1C	R.40065.2C	
<b>PASSPORT</b>									
94-11/95	2.6L (4 CYL.)	F	R.43009	R.43009	R.43009.1S	R.43009.2S	R.43009.1C	R.43009.2C	
		R							
94-11/95	3.2L (6 CYL.)	F	R.43013	R.43013	R.43013.1S	R.43013.2S	R.43013.1C	R.43013.2C	
		R	R.43015	R.43015	R.43015.1S	R.43015.2S	R.43015.1C	R.43015.2C	
12/95-01	2.6L (4 CYL.) 2WD	F	R.43013	R.43013	R.43013.1S	R.43013.2S	R.43013.1C	R.43013.2C	
		R							
12/95-01	3.2L (6 CYL.)	F	R.43013	R.43013	R.43013.1S	R.43013.2S	R.43013.1C	R.43013.2C	
		R	R.43015	R.43015	R.43015.1S	R.43015.2S	R.43015.1C	R.43015.2C	
02	2WD	F	R.43018	R.43018	R.43018.1S	R.43018.2S	R.43018.1C	R.43018.2C	

BRAKE DISC		BASIC OEM		SLOTTED		DRILLED & SLOTTED		NOTES
MAKE/MODEL	AXLE	PART #		PART #		PART #		
YEAR	F/R	LEFT	RIGHT	LEFT	RIGHT	LEFT	RIGHT	
02	4WD	R						
		F	R.43018	R.43018	R.43018.1S	R.43018.2S	R.43018.1C	R.43018.2C
		R	R.43015	R.43015	R.43015.1S	R.43015.2S	R.43015.1C	R.43015.2C
<b>PILOT</b>								
03-07		F	R.40046	R.40046	R.40046.1S	R.40046.2S	R.40046.1C	R.40046.2C
		R	R.40053	R.40053	R.40053.1S	R.40053.2S	R.40053.1C	R.40053.2C
<b>PRELUDE</b>								
90	S	F	R.40011	R.40011	R.40011.1S	R.40011.2S	R.40011.1C	R.40011.2C
		R	R.40017	R.40017	R.40017.1S	R.40017.2S	R.40017.1C	R.40017.2C
90-91	SI	F	R.40018	R.40018	R.40018.1S	R.40018.2S	R.40018.1C	R.40018.2C
		R	R.40017	R.40017	R.40017.1S	R.40017.2S	R.40017.1C	R.40017.2C
92-96	S, SE, SI	F	R.40032	R.40032	R.40032.1S	R.40032.2S	R.40032.1C	R.40032.2C
		R	R.40016	R.40016	R.40016.1S	R.40016.2S	R.40016.1C	R.40016.2C
92-96	V-TEC	F	R.40034	R.40034	R.40034.1S	R.40034.2S	R.40034.1C	R.40034.2C
		R	R.40016	R.40016	R.40016.1S	R.40016.2S	R.40016.1C	R.40016.2C
97-01		F	R.40026	R.40026	R.40026.1S	R.40026.2S	R.40026.1C	R.40026.2C
		R	R.40040	R.40040	R.40040.1S	R.40040.2S	R.40040.1C	R.40040.2C
<b>RIDGELINE</b>								
06-07		F	R.40069	R.40069	R.40069.1S	R.40069.2S	R.40069.1C	R.40069.2C
		R	R.40070	R.40070	R.40070.1S	R.40070.2S	R.40070.1C	R.40070.2C
<b>S2000</b>								
00-07		F	R.40048	R.40048	R.40048.1S	R.40048.2S	R.40048.1C	R.40048.2C
		R	R.40050	R.40050	R.40050.1S	R.40050.2S	R.40050.1C	R.40050.2C
<b>HUMMER</b>								
<b>H2</b>								
03-07		F	R.66042	R.66042	R.66042.1S	R.66042.2S	R.66042.1C	R.66042.2C
		R	R.66043	R.66043	R.66043.1S	R.66043.2S	R.66043.1C	R.66043.2C
<b>H3</b>								
06-07		F	R.69001	R.69001	R.69001.1S	R.69001.2S	R.69001.1C	R.69001.2C
		R	R.69002	R.69002	R.69002.1S	R.69002.2S	R.69002.1C	R.69002.2C
<b>HYUNDAI</b>								
<b>ACCENT</b>								
95-99		F	R.51001	R.51001	R.51001.1S	R.51001.2S	R.51001.1C	R.51001.2C
		R						
00-02		F	R.51008	R.51008	R.51008.1S	R.51008.2S	R.51008.1C	R.51008.2C
		R						
03-05		F	R.51017	R.51017	R.51017.1S	R.51017.2S	R.51017.1C	R.51017.2C
		R						
06-07	W/ REAR DRUM	F	R.50015	R.50015	R.50015.1S	R.50015.2S	R.50015.1C	R.50015.2C
		R						
06-07	W/ REAR DISC	F	R.50015	R.50015	R.50015.1S	R.50015.2S	R.50015.1C	R.50015.2C
		R	R.50016	R.50016	R.50016.1S	R.50016.2S	R.50016.1C	R.50016.2C
<b>AZERA</b>								
06-07	GRANDEUR	F	R.51018	R.51018	R.51018.1S	R.51018.2S	R.51018.1C	R.51018.2C
		R	R.51022	R.51022	R.51022.1S	R.51022.2S	R.51022.1C	R.51022.2C
<b>ELANTRA</b>								
92-93		F	R.51003	R.51003	R.51003.1S	R.51003.2S	R.51003.1C	R.51003.2C
		R						
94-96	W/ REAR DRUM	F	R.51003	R.51003	R.51003.1S	R.51003.2S	R.51003.1C	R.51003.2C
		R						
94-96	W/ REAR DISC	F	R.51003	R.51003	R.51003.1S	R.51003.2S	R.51003.1C	R.51003.2C
		R	R.51004	R.51004	R.51004.1S	R.51004.2S	R.51004.1C	R.51004.2C
97-8/16/98	W/ REAR DRUM	F	R.51003	R.51003	R.51003.1S	R.51003.2S	R.51003.1C	R.51003.2C
		R						
97-8/16/98	W/ REAR DISC	F	R.51003	R.51003	R.51003.1S	R.51003.2S	R.51003.1C	R.51003.2C
		R	R.51006	R.51006	R.51006.1S	R.51006.2S	R.51006.1C	R.51006.2C
8/17/98-06	W/ REAR DRUM	F	R.46039	R.46039	R.46039.1S	R.46039.2S	R.46039.1C	R.46039.2C
		R						
8/17/98-06	W/ REAR DISC	F	R.46039	R.46039	R.46039.1S	R.46039.2S	R.46039.1C	R.46039.2C
		R	R.51006	R.51006	R.51006.1S	R.51006.2S	R.51006.1C	R.51006.2C
07	CANADA ONLY	F	R.51023	R.51023	R.51023.1S	R.51023.2S	R.51023.1C	R.51023.2C
	W/ REAR DRUM	R						
07	W/ REAR DISC	F	R.51023	R.51023	R.51023.1S	R.51023.2S	R.51023.1C	R.51023.2C
		R	R.51024	R.51024	R.51024.1S	R.51024.2S	R.51024.1C	R.51024.2C
<b>SANTA FE</b>								
7/00-02	W/ REAR DRUM	F	R.51009	R.51009	R.51009.1S	R.51009.2S	R.51009.1C	R.51009.2C

MAKE/MODEL		AXLE	BASIC OEM		SLOTTED		DRILLED & SLOTTED		NOTES
			PART #		PART #		PART #		
YEAR		F/R	LEFT	RIGHT	LEFT	RIGHT	LEFT	RIGHT	
7/00-02	W/ REAR DISC	R							
		F	R.51009	R.51009	R.51009.1S	R.51009.2S	R.51009.1C	R.51009.2C	
		R	R.51012	R.51012	R.51012.1S	R.51012.2S	R.51012.1C	R.51012.2C	
11/00-02	V6 (2WD)	F	R.51009	R.51009	R.51009.1S	R.51009.2S	R.51009.1C	R.51009.2C	
		R	R.51012	R.51012	R.51012.1S	R.51012.2S	R.51012.1C	R.51012.2C	
11/00-02	V6 (4WD)	F	R.51013	R.51013	R.51013.1S	R.51013.2S	R.51013.1C	R.51013.2C	
		R	R.51012	R.51012	R.51012.1S	R.51012.2S	R.51012.1C	R.51012.2C	
03-05	W/ 275MM FRONT DISC	F	R.51009	R.51009	R.51009.1S	R.51009.2S	R.51009.1C	R.51009.2C	
		R	R.51012	R.51012	R.51012.1S	R.51012.2S	R.51012.1C	R.51012.2C	
03-05	W/ 293MM FRONT DISC	F	R.51013	R.51013	R.51013.1S	R.51013.2S	R.51013.1C	R.51013.2C	
		R	R.51012	R.51012	R.51012.1S	R.51012.2S	R.51012.1C	R.51012.2C	
06		F	R.51013	R.51013	R.51013.1S	R.51013.2S	R.51013.1C	R.51013.2C	
		R	R.51012	R.51012	R.51012.1S	R.51012.2S	R.51012.1C	R.51012.2C	
<b>SONATA</b>									
89-93	W/ REAR DRUM	F	R.51000	R.51000	R.51000.1S	R.51000.2S	R.51000.1C	R.51000.2C	
		R							
89-93	W/ REAR DISC	F	R.51000	R.51000	R.51000.1S	R.51000.2S	R.51000.1C	R.51000.2C	
		R	R.51002	R.51002	R.51002.1S	R.51002.2S	R.51002.1C	R.51002.2C	
94-98	W/ REAR DRUM	F	R.51000	R.51000	R.51000.1S	R.51000.2S	R.51000.1C	R.51000.2C	
		R							
94-98	W/ REAR DISC	F	R.51000	R.51000	R.51000.1S	R.51000.2S	R.51000.1C	R.51000.2C	
		R	R.51005	R.51005	R.51005.1S	R.51005.2S	R.51005.1C	R.51005.2C	
99-01	W/ REAR DRUM	F	R.46039	R.46039	R.46039.1S	R.46039.2S	R.46039.1C	R.46039.2C	
		R							
99-01	W/ REAR DISC	F	R.46039	R.46039	R.46039.1S	R.46039.2S	R.46039.1C	R.46039.2C	
		R	R.51007	R.51007	R.51007.1S	R.51007.2S	R.51007.1C	R.51007.2C	
02-3/03	W/ REAR DRUM	F	R.51014	R.51014	R.51014.1S	R.51014.2S	R.51014.1C	R.51014.2C	
		R							
02-3/03	W/ REAR DISC	F	R.51014	R.51014	R.51014.1S	R.51014.2S	R.51014.1C	R.51014.2C	
		R	R.51007	R.51007	R.51007.1S	R.51007.2S	R.51007.1C	R.51007.2C	
4/03-8/03	W/O ABS	F	R.50010	R.50010	R.50010.1S	R.50010.2S	R.50010.1C	R.50010.2C	
		R	R.51007	R.51007	R.51007.1S	R.51007.2S	R.51007.1C	R.51007.2C	
4/03-8/03	W/ ABS	F	R.51014	R.51014	R.51014.1S	R.51014.2S	R.51014.1C	R.51014.2C	
		R	R.51007	R.51007	R.51007.1S	R.51007.2S	R.51007.1C	R.51007.2C	
9/03-05		F	R.50010	R.50010	R.50010.1S	R.50010.2S	R.50010.1C	R.50010.2C	
		R	R.51007	R.51007	R.51007.1S	R.51007.2S	R.51007.1C	R.51007.2C	
06-07	2.4L (4 CYL.)	F	R.51015	R.51015	R.51015.1S	R.51015.2S	R.51015.1C	R.51015.2C	
		R	R.51011	R.51011	R.51011.1S	R.51011.2S	R.51011.1C	R.51011.2C	
06-07	3.3L (V6)	F	R.51020	R.51020	R.51020.1S	R.51020.2S	R.51020.1C	R.51020.2C	
		R	R.51021	R.51021	R.51021.1S	R.51021.2S	R.51021.1C	R.51021.2C	
<b>TIBURON</b>									
97-98	W/ REAR DRUM	F	R.51003	R.51003	R.51003.1S	R.51003.2S	R.51003.1C	R.51003.2C	
		R							
97-98	W/ REAR DISC	F	R.51003	R.51003	R.51003.1S	R.51003.2S	R.51003.1C	R.51003.2C	
		R	R.51006	R.51006	R.51006.1S	R.51006.2S	R.51006.1C	R.51006.2C	
99-01	W/ REAR DRUM	F	R.46039	R.46039	R.46039.1S	R.46039.2S	R.46039.1C	R.46039.2C	
		R							
99-01	W/ REAR DISC	F	R.46039	R.46039	R.46039.1S	R.46039.2S	R.46039.1C	R.46039.2C	
		R	R.51006	R.51006	R.51006.1S	R.51006.2S	R.51006.1C	R.51006.2C	
03-07		F	R.51015	R.51015	R.51015.1S	R.51015.2S	R.51015.1C	R.51015.2C	
		R	R.51016	R.51016	R.51016.1S	R.51016.2S	R.51016.1C	R.51016.2C	
<b>TUSCON</b>									
05-07	2WD	F	R.51015	R.51015	R.51015.1S	R.51015.2S	R.51015.1C	R.51015.2C	
		R	R.51011	R.51011	R.51011.1S	R.51011.2S	R.51011.1C	R.51011.2C	
05-07	4WD	F	R.51015	R.51015	R.51015.1S	R.51015.2S	R.51015.1C	R.51015.2C	
		R	R.51012	R.51012	R.51012.1S	R.51012.2S	R.51012.1C	R.51012.2C	
<b>XG 300, XG 350</b>									
01-03		F	R.51010	R.51010	R.51010.1S	R.51010.2S	R.51010.1C	R.51010.2C	
		R	R.51011	R.51011	R.51011.1S	R.51011.2S	R.51011.1C	R.51011.2C	
04-05		F	R.51018	R.51018	R.51018.1S	R.51018.2S	R.51018.1C	R.51018.2C	
		R	R.51011	R.51011	R.51011.1S	R.51011.2S	R.51011.1C	R.51011.2C	
<b>INFINITI</b>									
<b>FX35, FX45</b>									
03-11/05		F	R.42080	R.42080	R.42080.1S	R.42080.2S	R.42080.1C	R.42080.2C	
		R	R.42078	R.42078	R.42078.1S	R.42078.2S	R.42078.1C	R.42078.2C	
12/05-07		F	R.42092	R.42092	R.42092.1S	R.42092.2S	R.42092.1C	R.42092.2C	
		R	R.42078	R.42078	R.42078.1S	R.42078.2S	R.42078.1C	R.42078.2C	

BRAKE DISC		BASIC OEM		SLOTTED		DRILLED & SLOTTED		NOTES
MAKE/MODEL	AXLE	PART #		PART #		PART #		
YEAR	F/R	LEFT	RIGHT	LEFT	RIGHT	LEFT	RIGHT	
<b>G20</b>								
91-97	F	R.42041	R.42041	R.42041.1S	R.42041.2S	R.42041.1C	R.42041.2C	
	R	R.42051	R.42051	R.42051.1S	R.42051.2S	R.42051.1C	R.42051.2C	
99-02	F	R.42055	R.42055	R.42055.1S	R.42055.2S	R.42055.1C	R.42055.2C	
	R	R.42051	R.42051	R.42051.1S	R.42051.2S	R.42051.1C	R.42051.2C	
<b>G35</b>								
02-8/02	F	R.42074	R.42074	R.42074.1S	R.42074.2S	R.42074.1C	R.42074.2C	
	R	R.42077	R.42077	R.42077.1S	R.42077.2S	R.42077.1C	R.42077.2C	
9/02-04	STD BRAKE	F	R.42074	R.42074	R.42074.1S	R.42074.2S	R.42074.1C	R.42074.2C
		R	R.42077	R.42077	R.42077.1S	R.42077.2S	R.42077.1C	R.42077.2C
9/02-04	W/ BREMBO CALIPER	F	R.42076	R.42076	R.42076.1S	R.42076.2S	R.42076.1C	R.42076.2C
		R	R.42079	R.42079	R.42079.1S	R.42079.2S	R.42079.1C	R.42079.2C
05	2WD	F	R.42080	R.42080	R.42080.1S	R.42080.2S	R.42080.1C	R.42080.2C
		R	R.42088	R.42088	R.42088.1S	R.42088.2S	R.42088.1C	R.42088.2C
05	4WD	F	R.42074	R.42074	R.42074.1S	R.42074.2S	R.42074.1C	R.42074.2C
		R	R.42077	R.42077	R.42077.1S	R.42077.2S	R.42077.1C	R.42077.2C
06	2WD, 4WD	F	R.42080	R.42080	R.42080.1S	R.42080.2S	R.42080.1C	R.42080.2C
		R	R.42088	R.42088	R.42088.1S	R.42088.2S	R.42088.1C	R.42088.2C
07	2WD, 4WD (EXC SPORT SEDAN)	F	R.42080	R.42080	R.42080.1S	R.42080.2S	R.42080.1C	R.42080.2C
		R	R.42088	R.42088	R.42088.1S	R.42088.2S	R.42088.1C	R.42088.2C
07	2WD (SPORT SEDAN)	F	R.42095	R.42095	R.42095.1S	R.42095.2S	R.42095.1C	R.42095.2C
		R	R.42093	R.42093	R.42093.1S	R.42093.2S	R.42093.1C	R.42093.2C
<b>I30, I35</b>								
95-99	F	R.42043	R.42043	R.42043.1S	R.42043.2S	R.42043.1C	R.42043.2C	
	R	R.42059	R.42059	R.42059.1S	R.42059.2S	R.42059.1C	R.42059.2C	
00-01	F	R.42069	R.42069	R.42069.1S	R.42069.2S	R.42069.1C	R.42069.2C	
	R	R.42059	R.42059	R.42059.1S	R.42059.2S	R.42059.1C	R.42059.2C	
02-04	F	R.42070	R.42070	R.42070.1S	R.42070.2S	R.42070.1C	R.42070.2C	
	R	R.42059	R.42059	R.42059.1S	R.42059.2S	R.42059.1C	R.42059.2C	
<b>J30</b>								
92-97	F	R.42048	R.42048	R.42048.1S	R.42048.2S	R.42048.1C	R.42048.2C	
	R	R.42058	R.42058	R.42058.1S	R.42058.2S	R.42058.1C	R.42058.2C	
<b>M35, M45</b>								
03-05	F	R.42071	R.42071	R.42071.1S	R.42071.2S	R.42071.1C	R.42071.2C	
	R	R.42072	R.42072	R.42072.1S	R.42072.2S	R.42072.1C	R.42072.2C	
06-07	F	R.42080	R.42080	R.42080.1S	R.42080.2S	R.42080.1C	R.42080.2C	
	R	R.42088	R.42088	R.42088.1S	R.42088.2S	R.42088.1C	R.42088.2C	
<b>Q45</b>								
90-96	F	R.42048	R.42048	R.42048.1S	R.42048.2S	R.42048.1C	R.42048.2C	
	R	R.42049	R.42049	R.42049.1S	R.42049.2S	R.42049.1C	R.42049.2C	
97-01	F	R.42065	R.42065	R.42065.1S	R.42065.2S	R.42065.1C	R.42065.2C	
	R	R.42058	R.42058	R.42058.1S	R.42058.2S	R.42058.1C	R.42058.2C	
02-07	F	R.42071	R.42071	R.42071.1S	R.42071.2S	R.42071.1C	R.42071.2C	
	R	R.42072	R.42072	R.42072.1S	R.42072.2S	R.42072.1C	R.42072.2C	
<b>QX4, QX56</b>								
97	QX4	F	R.42063	R.42063	R.42063.1S	R.42063.2S	R.42063.1C	R.42063.2C
		R						
98-03	QX4	F	R.42068	R.42068	R.42068.1S	R.42068.2S	R.42068.1C	R.42068.2C
		R						
04-3/05	QX56	F	R.42084	R.42084	R.42084.1S	R.42084.2S	R.42084.1C	R.42084.2C
		R	R.42081	R.42081	R.42081.1S	R.42081.2S	R.42081.1C	R.42081.2C
4/05-10/06	BOSCH FRONT CALIPER 320MM FRONT DISC	F	R.42090	R.42090	R.42090.1S	R.42090.2S	R.42090.1C	R.42090.2C
		R	R.42081	R.42081	R.42081.1S	R.42081.2S	R.42081.1C	R.42081.2C
11/05-06	AKEBONO FRONT CALIPER 350MM FRONT DISC	F	R.42094	R.42094	R.42094.1S	R.42094.2S	R.42094.1C	R.42094.2C
		R	R.42081	R.42081	R.42081.1S	R.42081.2S	R.42081.1C	R.42081.2C
<b>ISUZU</b>								
<b>ASCENDER</b>								
03	F	R.66053	R.66053	R.66053.1S	R.66053.2S	R.66053.1C	R.66053.2C	A
	R	R.66052	R.66052	R.66052.1S	R.66052.2S	R.66052.1C	R.66052.2C	A
04-07	REG (5 PASSENGER)	F	R.66051	R.66051	R.66051.1S	R.66051.2S	R.66051.1C	R.66051.2C
		R	R.66052	R.66052	R.66052.1S	R.66052.2S	R.66052.1C	R.66052.2C
04-07	EXT (7 PASSENGER)	F	R.66053	R.66053	R.66053.1S	R.66053.2S	R.66053.1C	R.66053.2C
		R	R.66052	R.66052	R.66052.1S	R.66052.2S	R.66052.1C	R.66052.2C
<b>RODEO (EXC SPORT)</b>								
91-10/92	F	R.43009	R.43009	R.43009.1S	R.43009.2S	R.43009.1C	R.43009.2C	
	R							
11/92-97	2.6L 4 CYL. (W/ REAR DRUM)	F	R.43009	R.43009	R.43009.1S	R.43009.2S	R.43009.1C	R.43009.2C

BRAKE DISC		BASIC OEM		SLOTTED		DRILLED & SLOTTED		
MAKE/MODEL	AXLE	PART #		PART #		PART #		NOTES
YEAR	F/R	LEFT	RIGHT	LEFT	RIGHT	LEFT	RIGHT	
11/92-97	R							
3.2L V6 (W REAR DISC)	F	R.43013	R.43013	R.43013.1S	R.43013.2S	R.43013.1C	R.43013.2C	
	R	R.43015	R.43015	R.43015.1S	R.43015.2S	R.43015.1C	R.43015.2C	
98-6/01	F	R.43013	R.43013	R.43013.1S	R.43013.2S	R.43013.1C	R.43013.2C	
2WD	R							
98-6/01	F	R.43013	R.43013	R.43013.1S	R.43013.2S	R.43013.1C	R.43013.2C	
4WD	R	R.43015	R.43015	R.43015.1S	R.43015.2S	R.43015.1C	R.43015.2C	
7/01-04	F	R.43018	R.43018	R.43018.1S	R.43018.2S	R.43018.1C	R.43018.2C	
	R							
7/01-04	F	R.43018	R.43018	R.43018.1S	R.43018.2S	R.43018.1C	R.43018.2C	
4WD	R	R.43015	R.43015	R.43015.1S	R.43015.2S	R.43015.1C	R.43015.2C	
<b>RODEO SPORT</b>								
01-6/01	F	R.43013	R.43013	R.43013.1S	R.43013.2S	R.43013.1C	R.43013.2C	
	R							
01-6/01	F	R.43013	R.43013	R.43013.1S	R.43013.2S	R.43013.1C	R.43013.2C	
4WD (W REAR DISC)	R	R.43015	R.43015	R.43015.1S	R.43015.2S	R.43015.1C	R.43015.2C	
7/01-03	F	R.43018	R.43018	R.43018.1S	R.43018.2S	R.43018.1C	R.43018.2C	
	R							
7/01-03	F	R.43018	R.43018	R.43018.1S	R.43018.2S	R.43018.1C	R.43018.2C	
4WD (W REAR DISC)	R	R.43015	R.43015	R.43015.1S	R.43015.2S	R.43015.1C	R.43015.2C	
<b>TROOPER</b>								
92-02	F	R.43013	R.43013	R.43013.1S	R.43013.2S	R.43013.1C	R.43013.2C	
	R	R.43015	R.43015	R.43015.1S	R.43015.2S	R.43015.1C	R.43015.2C	
<b>VEHICROSS</b>								
99-01	F	R.43013	R.43013	R.43013.1S	R.43013.2S	R.43013.1C	R.43013.2C	
	R	R.43015	R.43015	R.43015.1S	R.43015.2S	R.43015.1C	R.43015.2C	
<b>JAGUAR</b>								
<b>S TYPE</b>								
00-02	F	R.61060	R.61060	R.61060.1S	R.61060.2S	R.61060.1C	R.61060.2C	
	R	R.61062	R.61062	R.61062.1S	R.61062.2S	R.61062.1C	R.61062.2C	
03-05	F	R.61060	R.61060	R.61060.1S	R.61060.2S	R.61060.1C	R.61060.2C	
STD SUSPENSION	R	R.61062	R.61062	R.61062.1S	R.61062.2S	R.61062.1C	R.61062.2C	
03-05	F	R.61077	R.61077	R.61077.1S	R.61077.2S	R.61077.1C	R.61077.2C	
S TYPE (W SPORT SUSPENSION)	R	R.61062	R.61062	R.61062.1S	R.61062.2S	R.61062.1C	R.61062.2C	
<b>X TYPE</b>								
02-07	F	R.20016	R.20016	R.20016.1S	R.20016.2S	R.20016.1C	R.20016.2C	A
	R	R.20017	R.20017	R.20017.1S	R.20017.2S	R.20017.1C	R.20017.2C	A
<b>XJ 6-SOVERGN &amp; VANDEN PLAS</b>								
90-94	F	R.20009	R.20009	R.20009.1S	R.20009.2S	R.20009.1C	R.20009.2C	A
	R	R.20010	R.20010	R.20010.1S	R.20010.2S	R.20010.1C	R.20010.2C	A
95-97	F	R.20009	R.20009	R.20009.1S	R.20009.2S	R.20009.1C	R.20009.2C	A
	R	R.20013	R.20013	R.20013.1S	R.20013.2S	R.20013.1C	R.20013.2C	A
<b>XJ 8-VANDEN PLAS</b>								
98-03	F	R.20014	R.20014	R.20014.1S	R.20014.2S	R.20014.1C	R.20014.2C	A
	R	R.20013	R.20013	R.20013.1S	R.20013.2S	R.20013.1C	R.20013.2C	A
04-05	F	R.61077	R.61077	R.61077.1S	R.61077.2S	R.61077.1C	R.61077.2C	
	R	R.61062	R.61062	R.61062.1S	R.61062.2S	R.61062.1C	R.61062.2C	
<b>XJ 12</b>								
93-94	F	R.20011	R.20011	R.20011.1S	R.20011.2S	R.20011.1C	R.20011.2C	A
	R	R.20010	R.20010	R.20010.1S	R.20010.2S	R.20010.1C	R.20010.2C	A
95-96	F	R.20009	R.20009	R.20009.1S	R.20009.2S	R.20009.1C	R.20009.2C	A
	R	R.20013	R.20013	R.20013.1S	R.20013.2S	R.20013.1C	R.20013.2C	A
<b>XJ-R, XJR-S, XJ SPORT, XJ SUPER V8</b>								
93-94	F	R.20002	R.20002	R.20002.1S	R.20002.2S	R.20002.1C	R.20002.2C	A
	R	R.20010	R.20010	R.20010.1S	R.20010.2S	R.20010.1C	R.20010.2C	A
94-97	F	R.20002	R.20002	R.20002.1S	R.20002.2S	R.20002.1C	R.20002.2C	A
	R	R.20013	R.20013	R.20013.1S	R.20013.2S	R.20013.1C	R.20013.2C	A
98-01	F	R.20014	R.20014	R.20014.1S	R.20014.2S	R.20014.1C	R.20014.2C	A
305MM FRONT DISC	R	R.20013	R.20013	R.20013.1S	R.20013.2S	R.20013.1C	R.20013.2C	A
98-01	F	R.20015	R.20015	R.20015.1S	R.20015.2S	R.20015.1C	R.20015.2C	A
325MM FRONT DISC	R	R.20013	R.20013	R.20013.1S	R.20013.2S	R.20013.1C	R.20013.2C	A
<b>XJ-S, XJ-SC</b>								
1/87-93	F	R.20002	R.20002	R.20002.1S	R.20002.2S	R.20002.1C	R.20002.2C	A
	R	R.20008	R.20008	R.20008.1S	R.20008.2S	R.20008.1C	R.20008.2C	A
93-95	F	R.20002	R.20002	R.20002.1S	R.20002.2S	R.20002.1C	R.20002.2C	A
	R	R.20010	R.20010	R.20010.1S	R.20010.2S	R.20010.1C	R.20010.2C	A
95-96	F	R.20002	R.20002	R.20002.1S	R.20002.2S	R.20002.1C	R.20002.2C	A

BRAKE DISC		BASIC OEM		SLOTTED		DRILLED & SLOTTED		NOTES	
		AXLE	PART #		PART #		PART #		
MAKE/MODEL	YEAR	F/R	LEFT	RIGHT	LEFT	RIGHT	LEFT	RIGHT	
		R	R.20013	R.20013	R.20013.1S	R.20013.2S	R.20013.1C	R.20013.2C	A
<b>XK 8</b>									
97-98	W/ 305MM DISC	F	R.20014	R.20014	R.20014.1S	R.20014.2S	R.20014.1C	R.20014.2C	A
		R	R.20013	R.20013	R.20013.1S	R.20013.2S	R.20013.1C	R.20013.2C	A
99	W/ 305MM DISC	F	R.20014	R.20014	R.20014.1S	R.20014.2S	R.20014.1C	R.20014.2C	A
		R	R.20013	R.20013	R.20013.1S	R.20013.2S	R.20013.1C	R.20013.2C	A
99	W/ 325MM DISC	F	R.20015	R.20015	R.20015.1S	R.20015.2S	R.20015.1C	R.20015.2C	A
		R	R.20013	R.20013	R.20013.1S	R.20013.2S	R.20013.1C	R.20013.2C	A
00-06		F	R.20015	R.20015	R.20015.1S	R.20015.2S	R.20015.1C	R.20015.2C	A
		R	R.20013	R.20013	R.20013.1S	R.20013.2S	R.20013.1C	R.20013.2C	A
<b>XK R</b>									
00-02		F	R.20015	R.20015	R.20015.1S	R.20015.2S	R.20015.1C	R.20015.2C	A
		R							
<b>JEEP</b>									
<b>CHEROKEE, SPORTWAGON</b>									
90-1/92	2WD	F	R.63008	R.63008	R.63008.1S	R.63008.2S	R.63008.1C	R.63008.2C	
		R							
90-1/92	4WD	F	R.67022	R.67022	R.67022.1S	R.67022.2S	R.67022.1C	R.67022.2C	
		R							
2/92-99		F	R.67022	R.67022	R.67022.1S	R.67022.2S	R.67022.1C	R.67022.2C	
		R							
00-01		F	R.67045	R.67045	R.67045.1S	R.67045.2S	R.67045.1C	R.67045.2C	
		R							
<b>COMANCHE</b>									
90-92	2WD	F	R.63008	R.63008	R.63008.1S	R.63008.2S	R.63008.1C	R.63008.2C	
		R							
90-92	4WD	F	R.67022	R.67022	R.67022.1S	R.67022.2S	R.67022.1C	R.67022.2C	
		R							
<b>COMMANDER</b>									
06-07		F	R.58001	R.58001	R.58001.1S	R.58001.2S	R.58001.1C	R.58001.2C	
		R	R.58002	R.58002	R.58002.1S	R.58002.2S	R.58002.1C	R.58002.2C	
<b>COMPASS</b>									
07		F	R.63067	R.63067	R.63067.1S	R.63067.2S	R.63067.1C	R.63067.2C	C
		R	R.63066	R.63066	R.63066.1S	R.63066.2S	R.63066.1C	R.63066.2C	C
<b>GRAND CHEROKEE</b>									
93-94	W/ REAR DRUM	F	R.67022	R.67022	R.67022.1S	R.67022.2S	R.67022.1C	R.67022.2C	
		R							
93-94	W/ REAR DISC	F	R.67022	R.67022	R.67022.1S	R.67022.2S	R.67022.1C	R.67022.2C	
		R	R.67032	R.67032	R.67032.1S	R.67032.2S	R.67032.1C	R.67032.2C	
95-98		F	R.67022	R.67022	R.67022.1S	R.67022.2S	R.67022.1C	R.67022.2C	
		R	R.67032	R.67032	R.67032.1S	R.67032.2S	R.67032.1C	R.67032.2C	
99-04		F	R.67042	R.67042	R.67042.1S	R.67042.2S	R.67042.1C	R.67042.2C	
		R	R.67043	R.67043	R.67043.1S	R.67043.2S	R.67043.1C	R.67043.2C	
05		F	R.58001	R.58001	R.58001.1S	R.58001.2S	R.58001.1C	R.58001.2C	
		R	R.58002	R.58002	R.58002.1S	R.58002.2S	R.58002.1C	R.58002.2C	
06-07	EXC SRT-8	F	R.58001	R.58001	R.58001.1S	R.58001.2S	R.58001.1C	R.58001.2C	
		R	R.58002	R.58002	R.58002.1S	R.58002.2S	R.58002.1C	R.58002.2C	
06-07	SRT-8	F	R.58003	R.58003	R.58003.1S	R.58003.2S	R.58003.1C	R.58003.2C	C
		R	R.58004	R.58004	R.58004.1S	R.58004.2S	R.58004.1C	R.58004.2C	C
<b>LIBERTY</b>									
02		F	R.67052	R.67052	R.67052.1S	R.67052.2S	R.67052.1C	R.67052.2C	
		R							
03-07	W/ REAR DISC	F	R.67052	R.67052	R.67052.1S	R.67052.2S	R.67052.1C	R.67052.2C	
		R	R.67063	R.67063	R.67063.1S	R.67063.2S	R.67063.1C	R.67063.2C	
<b>PATRIOT</b>									
07		F	R.63067	R.63067	R.63067.1S	R.63067.2S	R.63067.1C	R.63067.2C	C
		R	R.63066	R.63066	R.63066.1S	R.63066.2S	R.63066.1C	R.63066.2C	C
<b>WRANGLER</b>									
90-98		F	R.67022	R.67022	R.67022.1S	R.67022.2S	R.67022.1C	R.67022.2C	
		R							
99		F	R.67022	R.67022	R.67022.1S	R.67022.2S	R.67022.1C	R.67022.2C	
		R							
99		F	R.67045	R.67045	R.67045.1S	R.67045.2S	R.67045.1C	R.67045.2C	
		R							
00-06	W/ REAR DRUM	F	R.67045	R.67045	R.67045.1S	R.67045.2S	R.67045.1C	R.67045.2C	
		R							
03-06	W/ REAR DISC	F	R.67045	R.67045	R.67045.1S	R.67045.2S	R.67045.1C	R.67045.2C	



MAKE/MODEL YEAR		AXLE F/R	BASIC OEM		SLOTTED		DRILLED & SLOTTED		NOTES
			PART #		PART #		PART #		
			LEFT	RIGHT	LEFT	RIGHT	LEFT	RIGHT	
		R	R.67063	R.67063	R.67063.1S	R.67063.2S	R.67063.1C	R.67063.2C	
07		F	R.67068	R.67068	R.67068.1S	R.67068.2S	R.67068.1C	R.67068.2C	C
		R	R.67067	R.67067	R.67067.1S	R.67067.2S	R.67067.1C	R.67067.2C	C
<b>KIA</b>									
<b>OPTIMA</b>									
01-7/02	W/ REAR DRUM	F	R.51014	R.51014	R.51014.1S	R.51014.2S	R.51014.1C	R.51014.2C	
		R							
01-7/02	W/ REAR DISC	F	R.51014	R.51014	R.51014.1S	R.51014.2S	R.51014.1C	R.51014.2C	
		R	R.51007	R.51007	R.51007.1S	R.51007.2S	R.51007.1C	R.51007.2C	
8/02-06		F	R.51010	R.51010	R.51010.1S	R.51010.2S	R.51010.1C	R.51010.2C	
		R	R.51007	R.51007	R.51007.1S	R.51007.2S	R.51007.1C	R.51007.2C	
07		F	R.51015	R.51015	R.51015.1S	R.51015.2S	R.51015.1C	R.51015.2C	
		R	R.51011	R.51011	R.51011.1S	R.51011.2S	R.51011.1C	R.51011.2C	
<b>SPECTRA</b>									
04-06		F	R.51012	R.51012	R.51012.1S	R.51012.2S	R.51012.1C	R.51012.2C	
		R	R.51013	R.51013	R.51013.1S	R.51013.2S	R.51013.1C	R.51013.2C	
07	W/ REAR DRUM	F	R.51012	R.51012	R.51012.1S	R.51012.2S	R.51012.1C	R.51012.2C	
		R							
07	W/ REAR DISC	F	R.51012	R.51012	R.51012.1S	R.51012.2S	R.51012.1C	R.51012.2C	
		R	R.51013	R.51013	R.51013.1S	R.51013.2S	R.51013.1C	R.51013.2C	
<b>SPORTAGE</b>									
05-07	2WD	F	R.51015	R.51015	R.51015.1S	R.51015.2S	R.51015.1C	R.51015.2C	
		R	R.51011	R.51011	R.51011.1S	R.51011.2S	R.51011.1C	R.51011.2C	
05-07	4WD	F	R.51015	R.51015	R.51015.1S	R.51015.2S	R.51015.1C	R.51015.2C	
		R	R.51012	R.51012	R.51012.1S	R.51012.2S	R.51012.1C	R.51012.2C	
<b>LAND ROVER</b>									
<b>DEFENDER 90</b>									
94-97		F	R.22001	R.22001	R.22001.1S	R.22001.2S	R.22001.1C	R.22001.2C	A
		R	R.22002	R.22002	R.22002.1S	R.22002.2S	R.22002.1C	R.22002.2C	A
<b>DEFENDER 110</b>									
93		F	R.22000	R.22000	R.22000.1S	R.22000.2S	R.22000.1C	R.22000.2C	A
		R							
<b>DISCOVERY</b>									
94-99		F	R.22000	R.22000	R.22000.1S	R.22000.2S	R.22000.1C	R.22000.2C	A
		R	R.22002	R.22002	R.22002.1S	R.22002.2S	R.22002.1C	R.22002.2C	A
<b>DISCOVERY SERIES II</b>									
99-04		F	R.22005	R.22005	R.22005.1S	R.22005.2S	R.22005.1C	R.22005.2C	A
		R	R.22004	R.22004	R.22004.1S	R.22004.2S	R.22004.1C	R.22004.2C	A
<b>FREELANDER</b>									
02-05		F	R.22006	R.22006	R.22006.1S	R.22006.2S	R.22006.1C	R.22006.2C	A
		R							
<b>LR3</b>									
05		F	R.22009	R.22009	R.22009.1S	R.22009.2S	R.22009.1C	R.22009.2C	
		R	R.22010	R.22010	R.22010.1S	R.22010.2S	R.22010.1C	R.22010.2C	
06-07	4.0L V6	F	R.22013	R.22013	R.22013.1S	R.22013.2S	R.22013.1C	R.22013.2C	
		R	R.22012	R.22012	R.22012.1S	R.22012.2S	R.22012.1C	R.22012.2C	
06-07	4.4L V8	F	R.22009	R.22009	R.22009.1S	R.22009.2S	R.22009.1C	R.22009.2C	
		R	R.22010	R.22010	R.22010.1S	R.22010.2S	R.22010.1C	R.22010.2C	
<b>RANGE ROVER</b>									
90-93	EXC 4.0 SE	F	R.22001	R.22001	R.22001.1S	R.22001.2S	R.22001.1C	R.22001.2C	A
		R	R.22002	R.22002	R.22002.1S	R.22002.2S	R.22002.1C	R.22002.2C	A
93-95		F	R.22001	R.22001	R.22001.1S	R.22001.2S	R.22001.1C	R.22001.2C	A
		R	R.22002	R.22002	R.22002.1S	R.22002.2S	R.22002.1C	R.22002.2C	A
93-96	4.0 SE	F	R.22003	R.22003	R.22003.1S	R.22003.2S	R.22003.1C	R.22003.2C	A
		R	R.22004	R.22004	R.22004.1S	R.22004.2S	R.22004.1C	R.22004.2C	A
97-02	4.0 SE & 4.6 HSE	F	R.22003	R.22003	R.22003.1S	R.22003.2S	R.22003.1C	R.22003.2C	A
		R	R.22004	R.22004	R.22004.1S	R.22004.2S	R.22004.1C	R.22004.2C	A
03-05	HSE	F	R.22007	R.22007	R.22007.1S	R.22007.2S	R.22007.1C	R.22007.2C	A
		R	R.22008	R.22008	R.22008.1S	R.22008.2S	R.22008.1C	R.22008.2C	A
06-07	HSE (EXC SPORT)	F	R.22016	R.22016	R.22016.1S	R.22016.2S	R.22016.1C	R.22016.2C	
	4.4L V8	R	R.22017	R.22017	R.22017.1S	R.22017.2S	R.22017.1C	R.22017.2C	
06-07	SUPERCHARGED (EXC SPORT)	F	R.22015	R.22015	R.22015.1S	R.22015.2S	R.22015.1C	R.22015.2C	
	4.2L V8 SUPERCHARGED	R	R.22017	R.22017	R.22017.1S	R.22017.2S	R.22017.1C	R.22017.2C	
06-07	SPORT HSE	F	R.22009	R.22009	R.22009.1S	R.22009.2S	R.22009.1C	R.22009.2C	
	4.4L V8	R	R.22010	R.22010	R.22010.1S	R.22010.2S	R.22010.1C	R.22010.2C	
06-07	SPORT SUPERCHARGED	F	R.22011	R.22011	R.22011.1S	R.22011.2S	R.22011.1C	R.22011.2C	

BRAKE DISC		BASIC OEM		SLOTTED		DRILLED & SLOTTED		NOTES
MAKE/MODEL	AXLE	PART #		PART #		PART #		
YEAR	F/R	LEFT	RIGHT	LEFT	RIGHT	LEFT	RIGHT	
4.2L V8 SUPERCHARGED	R	R.22010	R.22010	R.22010.1S	R.22010.2S	R.22010.1C	R.22010.2C	
<b>LEXUS</b>								
<b>ES 250, ES 300, ES 330, ES350</b>								
89-91 ES 250	F	R.44062	R.44062	R.44062.1S	R.44062.2S	R.44062.1C	R.44062.2C	
	R	R.44042	R.44042	R.44042.1S	R.44042.2S	R.44042.1C	R.44042.2C	
92-96 ES 300	F	R.44079	R.44079	R.44079.1S	R.44079.2S	R.44079.1C	R.44079.2C	
	R	R.44080	R.44080	R.44080.1S	R.44080.2S	R.44080.1C	R.44080.2C	
97-01 ES 300	F	R.44079	R.44079	R.44079.1S	R.44079.2S	R.44079.1C	R.44079.2C	
	R	R.44085	R.44085	R.44085.1S	R.44085.2S	R.44085.1C	R.44085.2C	
02 ES 300	F	R.44125	R.44125	R.44125.1S	R.44125.2S	R.44125.1C	R.44125.2C	
	R	R.44126	R.44126	R.44126.1S	R.44126.2S	R.44126.1C	R.44126.2C	
03-06 ES 300, 330	F	R.44088	R.44088	R.44088.1S	R.44088.2S	R.44088.1C	R.44088.2C	
	R	R.44126	R.44126	R.44126.1S	R.44126.2S	R.44126.1C	R.44126.2C	
07 ES 350	F	R.44146	R.44146	R.44146.1S	R.44146.2S	R.44146.1C	R.44146.2C	C
	R	R.44144	R.44144	R.44144.1S	R.44144.2S	R.44144.1C	R.44144.2C	C
<b>GS 300, GS 350, GS 400, GS 430, GS 450H</b>								
93-97 GS 300, 400, 430	F	R.44083	R.44083	R.44083.1S	R.44083.2S	R.44083.1C	R.44083.2C	
	R	R.44084	R.44084	R.44084.1S	R.44084.2S	R.44084.1C	R.44084.2C	
98-05 GS 300, 400, 430	F	R.44083	R.44083	R.44083.1S	R.44083.2S	R.44083.1C	R.44083.2C	
	R	R.44090	R.44090	R.44090.1S	R.44090.2S	R.44090.1C	R.44090.2C	
06 GS 300	F	R.44140	R.44139	R.44140.1S	R.44140.2S	R.44140.1C	R.44140.2C	B, C
	R	R.44141	R.44141	R.44141.1S	R.44141.2S	R.44141.1C	R.44141.2C	C
06 GS 430	F	R.44138	R.44137	R.44138.1S	R.44138.2S	R.44138.1C	R.44138.2C	B, C
	R	R.44141	R.44141	R.44141.1S	R.44141.2S	R.44141.1C	R.44141.2C	C
07 GS 350 (2WD) & GS430	F	R.44138	R.44137	R.44138.1S	R.44138.2S	R.44138.1C	R.44138.2C	B, C
	R	R.44141	R.44141	R.44141.1S	R.44141.2S	R.44141.1C	R.44141.2C	C
07 GS 350 (AWD)	F	R.44154	R.44155	R.44154.1S	R.44154.2S	R.44154.1C	R.44154.2C	C
	R	R.44141	R.44141	R.44141.1S	R.44141.2S	R.44141.1C	R.44141.2C	C
07 GS 450H (HYBRID)	F	R.44138	R.44137	R.44138.1S	R.44138.2S	R.44138.1C	R.44138.2C	B, C
	R	R.44141	R.44141	R.44141.1S	R.44141.2S	R.44141.1C	R.44141.2C	C
<b>GX 470</b>								
03-07	F	R.44127	R.44127	R.44127.1S	R.44127.2S	R.44127.1C	R.44127.2C	
	R	R.44128	R.44128	R.44128.1S	R.44128.2S	R.44128.1C	R.44128.2C	
<b>IS 250, IS 300, IS 350</b>								
00-05 IS 300	F	R.44083	R.44083	R.44083.1S	R.44083.2S	R.44083.1C	R.44083.2C	
	R	R.44090	R.44090	R.44090.1S	R.44090.2S	R.44090.1C	R.44090.2C	
06-07 IS 250	F	R.44125	R.44125	R.44125.1S	R.44125.2S	R.44125.1C	R.44125.2C	
	R	R.44142	R.44142	R.44142.1S	R.44142.2S	R.44142.1C	R.44142.2C	
06-07 IS 350	F	R.44138	R.44137	R.44138.1S	R.44138.2S	R.44138.1C	R.44138.2C	B, C
	R	R.44141	R.44141	R.44141.1S	R.44141.2S	R.44141.1C	R.44141.2C	C
<b>LS 400, LS 430, LS 460</b>								
89-92 LS 400	F	R.44067	R.44067	R.44067.1S	R.44067.2S	R.44067.1C	R.44067.2C	
	R	R.44068	R.44068	R.44068.1S	R.44068.2S	R.44068.1C	R.44068.2C	
93-94 LS 400	F	R.44083	R.44083	R.44083.1S	R.44083.2S	R.44083.1C	R.44083.2C	
	R	R.44084	R.44084	R.44084.1S	R.44084.2S	R.44084.1C	R.44084.2C	
95-00 LS 400	F	R.44107	R.44107	R.44107.1S	R.44107.2S	R.44107.1C	R.44107.2C	
	R	R.44084	R.44084	R.44084.1S	R.44084.2S	R.44084.1C	R.44084.2C	
01-06 LS 430	F	R.44122	R.44122	R.44122.1S	R.44122.2S	R.44122.1C	R.44122.2C	
	R	R.44123	R.44123	R.44123.1S	R.44123.2S	R.44123.1C	R.44123.2C	
07 LS 460, LS 460L W/O TOURING PKG	F	R.44148	R.44148	R.44148.1S	R.44148.2S	R.44148.1C	R.44148.2C	C
	R	R.44149	R.44149	R.44149.1S	R.44149.2S	R.44149.1C	R.44149.2C	C
07 LS 460L W/ TOURING PKG	F	R.44150	R.44151	R.44150.1S	R.44150.2S	R.44150.1C	R.44150.2C	C
	R	R.44152	R.44153	R.44152.1S	R.44152.2S	R.44152.1C	R.44152.2C	C
<b>LX 450, LX 470</b>								
96-97 LX 450	F	R.44093	R.44093	R.44093.1S	R.44093.2S	R.44093.1C	R.44093.2C	
	R	R.44094	R.44094	R.44094.1S	R.44094.2S	R.44094.1C	R.44094.2C	
98-07 LX 470	F	R.44086	R.44086	R.44086.1S	R.44086.2S	R.44086.1C	R.44086.2C	
	R	R.44087	R.44087	R.44087.1S	R.44087.2S	R.44087.1C	R.44087.2C	
<b>RX 300, RX 330, RX 350, RX 400H</b>								
98-03 RX 300 (2WD)	F	R.44088	R.44088	R.44088.1S	R.44088.2S	R.44088.1C	R.44088.2C	
	R	R.44080	R.44080	R.44080.1S	R.44080.2S	R.44080.1C	R.44080.2C	
98-03 RX 300 (AWD)	F	R.44088	R.44088	R.44088.1S	R.44088.2S	R.44088.1C	R.44088.2C	
	R	R.44089	R.44089	R.44089.1S	R.44089.2S	R.44089.1C	R.44089.2C	
04-07 RX 330, 350, 400H (HYBRID)	F	R.44130	R.44130	R.44130.1S	R.44130.2S	R.44130.1C	R.44130.2C	
	R	R.44131	R.44131	R.44131.1S	R.44131.2S	R.44131.1C	R.44131.2C	
08 RX 350	F	R.44130	R.44130	R.44130.1S	R.44130.2S	R.44130.1C	R.44130.2C	
	R	R.44131	R.44131	R.44131.1S	R.44131.2S	R.44131.1C	R.44131.2C	

BRAKE DISC		BASIC OEM		SLOTTED		DRILLED & SLOTTED		NOTES
MAKE/MODEL	AXLE	PART #		PART #		PART #		
YEAR	F/R	LEFT	RIGHT	LEFT	RIGHT	LEFT	RIGHT	
<b>SC 300, SC 400, SC 430</b>								
92-98	SC 300	F	R.44081	R.44081	R.44081.1S	R.44081.2S	R.44081.1C	R.44081.2C
		R	R.44082	R.44082	R.44082.1S	R.44082.2S	R.44082.1C	R.44082.2C
92-98	SC 400	F	R.44083	R.44083	R.44083.1S	R.44083.2S	R.44083.1C	R.44083.2C
		R	R.44084	R.44084	R.44084.1S	R.44084.2S	R.44084.1C	R.44084.2C
99-00	SC 300, SC 400	F	R.44083	R.44083	R.44083.1S	R.44083.2S	R.44083.1C	R.44083.2C
		R	R.44084	R.44084	R.44084.1S	R.44084.2S	R.44084.1C	R.44084.2C
02-07	SC 430	F	R.44083	R.44083	R.44083.1S	R.44083.2S	R.44083.1C	R.44083.2C
		R	R.44090	R.44090	R.44090.1S	R.44090.2S	R.44090.1C	R.44090.2C
<b>LINCOLN</b>								
<b>AVIATOR</b>								
03-05		F	R.65093	R.65093	R.65093.1S	R.65093.2S	R.65093.1C	R.65093.2C
		R	R.65094	R.65094	R.65094.1S	R.65094.2S	R.65094.1C	R.65094.2C
<b>BLACKWOOD</b>								
02		F	R.65080	R.65080	R.65080.1S	R.65080.2S	R.65080.1C	R.65080.2C
		R	R.65085	R.65085	R.65085.1S	R.65085.2S	R.65085.1C	R.65085.2C
<b>CONTINENTAL</b>								
90-1/91		F	R.61022	R.61022	R.61022.1S	R.61022.2S	R.61022.1C	R.61022.2C
		R	R.61036	R.61036	R.61036.1S	R.61036.2S	R.61036.1C	R.61036.2C
2/91-92		F	R.61033	R.61033	R.61033.1S	R.61033.2S	R.61033.1C	R.61033.2C
		R	R.61036	R.61036	R.61036.1S	R.61036.2S	R.61036.1C	R.61036.2C
93-94		F	R.65051	R.65051	R.65051.1S	R.65051.2S	R.65051.1C	R.65051.2C
		R	R.61039	R.61039	R.61039.1S	R.61039.2S	R.61039.1C	R.61039.2C
95-02		F	R.61049	R.61049	R.61049.1S	R.61049.2S	R.61049.1C	R.61049.2C
		R	R.61039	R.61039	R.61039.1S	R.61039.2S	R.61039.1C	R.61039.2C
<b>LS</b>								
00-06		F	R.61060	R.61060	R.61060.1S	R.61060.2S	R.61060.1C	R.61060.2C
		R	R.61062	R.61062	R.61062.1S	R.61062.2S	R.61062.1C	R.61062.2C
<b>MARK LT</b>								
06-07	2WD	F	R.65099	R.65099	R.65099.1S	R.65099.2S	R.65099.1C	R.65099.2C
		R	R.65103	R.65103	R.65103.1S	R.65103.2S	R.65103.1C	R.65103.2C
06-07	4WD	F	R.65101	R.65101	R.65101.1S	R.65101.2S	R.65101.1C	R.65101.2C
		R	R.65103	R.65103	R.65103.1S	R.65103.2S	R.65103.1C	R.65103.2C
<b>MARK VII, VIII</b>								
90	W/O ABS	F	R.61018	R.61018	R.61018.1S	R.61018.2S	R.61018.1C	R.61018.2C
		R	R.61021	R.61021	R.61021.1S	R.61021.2S	R.61021.1C	R.61021.2C
90	W/ ABS	F	R.61030	R.61030	R.61030.1S	R.61030.2S	R.61030.1C	R.61030.2C
		R	R.61021	R.61021	R.61021.1S	R.61021.2S	R.61021.1C	R.61021.2C
91-92		F	R.61030	R.61030	R.61030.1S	R.61030.2S	R.61030.1C	R.61030.2C
		R	R.61040	R.61040	R.61040.1S	R.61040.2S	R.61040.1C	R.61040.2C
93-98		F	R.61049	R.61049	R.61049.1S	R.61049.2S	R.61049.1C	R.61049.2C
		R	R.61037	R.61037	R.61037.1S	R.61037.2S	R.61037.1C	R.61037.2C
<b>MK X</b>								
07	2WD	F	R.61092	R.61092	R.61092.1S	R.61092.2S	R.61092.1C	R.61092.2C
		R	R.61091	R.61091	R.61091.1S	R.61091.2S	R.61091.1C	R.61091.2C
07	4WD	F	R.61090	R.61090	R.61090.1S	R.61090.2S	R.61090.1C	R.61090.2C
		R	R.61091	R.61091	R.61091.1S	R.61091.2S	R.61091.1C	R.61091.2C
<b>MK Z</b>								
07	3.5L	F	R.61088	R.61088	R.61088.1S	R.61088.2S	R.61088.1C	R.61088.2C
		R	R.45064	R.45064	R.45064.1S	R.45064.2S	R.45064.1C	R.45064.2C
<b>NAVIGATOR</b>								
97-11/29/99	2WD	F	R.65063	R.65063	R.65063.1S	R.65063.2S	R.65063.1C	R.65063.2C
		R	R.65059	R.65059	R.65059.1S	R.65059.2S	R.65059.1C	R.65059.2C
97-11/29/99	4WD	F	R.65058	R.65058	R.65058.1S	R.65058.2S	R.65058.1C	R.65058.2C
		R	R.65059	R.65059	R.65059.1S	R.65059.2S	R.65059.1C	R.65059.2C
11/30/99-3/18/02	2WD	F	R.65081	R.65081	R.65081.1S	R.65081.2S	R.65081.1C	R.65081.2C
		R	R.65085	R.65085	R.65085.1S	R.65085.2S	R.65085.1C	R.65085.2C
11/30/99-3/18/02	4WD	F	R.65088	R.65088	R.65088.1S	R.65088.2S	R.65088.1C	R.65088.2C
		R	R.65085	R.65085	R.65085.1S	R.65085.2S	R.65085.1C	R.65085.2C
3/19/02-06		F	R.65097	R.65097	R.65097.1S	R.65097.2S	R.65097.1C	R.65097.2C
		R	R.65095	R.65095	R.65095.1S	R.65095.2S	R.65095.1C	R.65095.2C
07		F	R.65119	R.65119	R.65119.1S	R.65119.2S	R.65119.1C	R.65119.2C
		R	R.65120	R.65120	R.65120.1S	R.65120.2S	R.65120.1C	R.65120.2C
<b>TOWN CAR</b>								
98-02	EXC LIMO	F	R.61055	R.61055	R.61055.1S	R.61055.2S	R.61055.1C	R.61055.2C
		R	R.61052	R.61052	R.61052.1S	R.61052.2S	R.61052.1C	R.61052.2C
98-02	LIMO (W/ REAR DRUM)	F	R.61055	R.61055	R.61055.1S	R.61055.2S	R.61055.1C	R.61055.2C

BRAKE DISC		BASIC OEM		SLOTTED		DRILLED & SLOTTED		NOTES	
		AXLE	PART #		PART #		PART #		
MAKE/MODEL	YEAR	F/R	LEFT	RIGHT	LEFT	RIGHT	LEFT	RIGHT	
03-04	EXC LIMO	R							
		F	R.61072	R.61072	R.61072.1S	R.61072.2S	R.61072.1C	R.61072.2C	
		R	R.61075	R.61075	R.61075.1S	R.61075.2S	R.61075.1C	R.61075.2C	
03-04	LIMO (W/ REAR DRUM)	R	R.61072	R.61072	R.61072.1S	R.61072.2S	R.61072.1C	R.61072.2C	
		F							
03-04	LIMO (W/ REAR DISC)	F	R.61072	R.61072	R.61072.1S	R.61072.2S	R.61072.1C	R.61072.2C	
		R	R.61076	R.61076	R.61076.1S	R.61076.2S	R.61076.1C	R.61076.2C	
05-07	EXC LIMO	F	R.61072	R.61072	R.61072.1S	R.61072.2S	R.61072.1C	R.61072.2C	
		R	R.61075	R.61075	R.61075.1S	R.61075.2S	R.61075.1C	R.61075.2C	
05-07	LIMO (W/ REAR DISC)	F	R.61072	R.61072	R.61072.1S	R.61072.2S	R.61072.1C	R.61072.2C	
		R	R.61076	R.61076	R.61076.1S	R.61076.2S	R.61076.1C	R.61076.2C	
<b>ZEPHYR</b>									
06		F	R.61088	R.61088	R.61088.1S	R.61088.2S	R.61088.1C	R.61088.2C	
		R	R.45064	R.45064	R.45064.1S	R.45064.2S	R.45064.1C	R.45064.2C	
<b>MAZDA</b>									
<b>CX-7</b>									
07		F	R.45076	R.45076	R.45076.1S	R.45076.2S	R.45076.1C	R.45076.2C	c
		R	R.45077	R.45077	R.45077.1S	R.45077.2S	R.45077.1C	R.45077.2C	c
<b>CX-9</b>									
07		F	R.45080	R.45080	R.45080.1S	R.45080.2S	R.45080.1C	R.45080.2C	c
		R	R.45079	R.45079	R.45079.1S	R.45079.2S	R.45079.1C	R.45079.2C	c
<b>MIATA MX-5</b>									
89-93		F	R.45034	R.45034	R.45034.1S	R.45034.2S	R.45034.1C	R.45034.2C	
		R	R.45035	R.45035	R.45035.1S	R.45035.2S	R.45035.1C	R.45035.2C	
94-00		F	R.45050	R.45050	R.45050.1S	R.45050.2S	R.45050.1C	R.45050.2C	
		R	R.45041	R.45041	R.45041.1S	R.45041.2S	R.45041.1C	R.45041.2C	
01-03	EXC SPORT SUSPENSION	F	R.45050	R.45050	R.45050.1S	R.45050.2S	R.45050.1C	R.45050.2C	
		R	R.45041	R.45041	R.45041.1S	R.45041.2S	R.45041.1C	R.45041.2C	
01-03	W/ SPORT SUSPENSION	F	R.45061	R.45061	R.45061.1S	R.45061.2S	R.45061.1C	R.45061.2C	
		R	R.45062	R.45062	R.45062.1S	R.45062.2S	R.45062.1C	R.45062.2C	
04-05	EXC SPORT SUSPENSION	F	R.45050	R.45050	R.45050.1S	R.45050.2S	R.45050.1C	R.45050.2C	
		R	R.45041	R.45041	R.45041.1S	R.45041.2S	R.45041.1C	R.45041.2C	
04-05	W/ SPORT SUSPENSION	F	R.45061	R.45061	R.45061.1S	R.45061.2S	R.45061.1C	R.45061.2C	
		R	R.45062	R.45062	R.45062.1S	R.45062.2S	R.45062.1C	R.45062.2C	
04-05	MAZDASPEED MX-5 TURBO	F	R.45061	R.45061	R.45061.1S	R.45061.2S	R.45061.1C	R.45061.2C	
		R	R.45062	R.45062	R.45062.1S	R.45062.2S	R.45062.1C	R.45062.2C	
06-07		F	R.45075	R.45075	R.45075.1S	R.45075.2S	R.45075.1C	R.45075.2C	
		R	R.45064	R.45064	R.45064.1S	R.45064.2S	R.45064.1C	R.45064.2C	
<b>MX-3</b>									
92-95	4 CYL. (W/ REAR DRUM)	F	R.45040	R.45040	R.45040.1S	R.45040.2S	R.45040.1C	R.45040.2C	
		R							
92-95	4 CYL., V6 (W/ REAR DISC)	F	R.45040	R.45040	R.45040.1S	R.45040.2S	R.45040.1C	R.45040.2C	
		R	R.45041	R.45041	R.45041.1S	R.45041.2S	R.45041.1C	R.45041.2C	
<b>MX-5 (SEE MIATA MX-5)</b>									
<b>MX-6</b>									
89-90	W/ REAR DRUM	F	R.45026	R.45026	R.45026.1S	R.45026.2S	R.45026.1C	R.45026.2C	
		R							
89-90	W/ REAR DISC	F	R.45026	R.45026	R.45026.1S	R.45026.2S	R.45026.1C	R.45026.2C	
	2 WHEEL STEERING	R	R.45027	R.45027	R.45027.1S	R.45027.2S	R.45027.1C	R.45027.2C	
89-90	W/ REAR DISC	F	R.45026	R.45026	R.45026.1S	R.45026.2S	R.45026.1C	R.45026.2C	
	4 WHEEL STEERING	R	R.45037	R.45037	R.45037.1S	R.45037.2S	R.45037.1C	R.45037.2C	
91-92	W/ REAR DRUM	F	R.45026	R.45026	R.45026.1S	R.45026.2S	R.45026.1C	R.45026.2C	
		R							
91-92	W/ REAR DISC	F	R.45026	R.45026	R.45026.1S	R.45026.2S	R.45026.1C	R.45026.2C	
		R	R.45027	R.45027	R.45027.1S	R.45027.2S	R.45027.1C	R.45027.2C	
93-97	W/ REAR DRUM	F	R.45048	R.45048	R.45048.1S	R.45048.2S	R.45048.1C	R.45048.2C	
		R							
93-97	GT (W/ REAR DISC)	F	R.45048	R.45048	R.45048.1S	R.45048.2S	R.45048.1C	R.45048.2C	
		R	R.45049	R.45049	R.45049.1S	R.45049.2S	R.45049.1C	R.45049.2C	
<b>PROTÉGÉ</b>									
90-98	SOHC (W/ REAR DRUM)	F	R.45039	R.45039	R.45039.1S	R.45039.2S	R.45039.1C	R.45039.2C	
		R							
90-98	DOHC (W/ REAR DISC)	F	R.45040	R.45040	R.45040.1S	R.45040.2S	R.45040.1C	R.45040.2C	
		R	R.45041	R.45041	R.45041.1S	R.45041.2S	R.45041.1C	R.45041.2C	
99-00	1.6L ENG	F	R.45039	R.45039	R.45039.1S	R.45039.2S	R.45039.1C	R.45039.2C	
		R							
99-00	1.8L ENG	F	R.45058	R.45058	R.45058.1S	R.45058.2S	R.45058.1C	R.45058.2C	

BRAKE DISC		BASIC OEM		SLOTTED		DRILLED & SLOTTED		NOTES	
MAKE/MODEL		AXLE	PART #		PART #		PART #		
YEAR		F/R	LEFT	RIGHT	LEFT	RIGHT	LEFT		RIGHT
01	1.6L ENG	R F	R.45039	R.45039	R.45039.1S	R.45039.2S	R.45039.1C	R.45039.2C	
01	2.0L ENG (W/ REAR DRUM)	F R	R.45058	R.45058	R.45058.1S	R.45058.2S	R.45058.1C	R.45058.2C	
01	2.0L ENG ES (W/ REAR DISC)	F R	R.45048 R.45049	R.45048 R.45049	R.45048.1S R.45049.1S	R.45048.2S R.45049.2S	R.45048.1C R.45049.1C	R.45048.2C R.45049.2C	
02-03	DX, LX (W/ REAR DRUM)	F R	R.45058	R.45058	R.45058.1S	R.45058.2S	R.45058.1C	R.45058.2C	
02-03	ES (W/ REAR DISC)	F R	R.45048 R.45049	R.45048 R.45049	R.45048.1S R.45049.1S	R.45048.2S R.45049.2S	R.45048.1C R.45049.1C	R.45048.2C R.45049.2C	
02-03	PROTÉGÉ 5	F R	R.45048 R.45049	R.45048 R.45049	R.45048.1S R.45049.1S	R.45048.2S R.45049.2S	R.45048.1C R.45049.1C	R.45048.2C R.45049.2C	
03	PROTÉGÉ MAZDASPEED	F R	R.45045 R.45064	R.45045 R.45064	R.45045.1S R.45064.1S	R.45045.2S R.45064.2S	R.45064.1C	R.45064.2C	
<b>RX7</b>									
86-88	4 LUG	F R	R.45021 R.45023	R.45021 R.45023	R.45021.1S R.45023.1S	R.45021.2S R.45023.2S	R.45021.1C R.45023.1C	R.45021.2C R.45023.2C	
86-88	5 LUG (TURBO/NON TURBO)	F R	R.45022 R.45024	R.45022 R.45024	R.45022.1S R.45024.1S	R.45022.2S R.45024.2S	R.45022.1C R.45024.1C	R.45022.2C R.45024.2C	
89-92	W/ SOLID REAR DISC	F R	R.45022 R.45036	R.45022 R.45036	R.45022.1S R.45036.1S	R.45022.2S R.45036.2S	R.45022.1C R.45036.1C	R.45022.2C R.45036.2C	
89-92	W/ VENTED REAR DISC	F R	R.45022 R.45024	R.45022 R.45024	R.45022.1S R.45024.1S	R.45022.2S R.45024.2S	R.45022.1C R.45024.1C	R.45022.2C R.45024.2C	
93-95		F R	R.45051 R.45052	R.45051 R.45052	R.45051.1S R.45052.1S	R.45051.2S R.45052.2S	R.45051.1C R.45052.1C	R.45051.2C R.45052.2C	
<b>RX8</b>									
04-07	W/ SPORT SUSPENSION	F R	R.45071 R.45072	R.45071 R.45072	R.45071.1S R.45072.1S	R.45071.2S R.45072.2S	R.45071.1C R.45072.1C	R.45071.2C R.45072.2C	
04-07	EXC SPORT SUSPENSION	F R	R.45070 R.45072	R.45070 R.45072	R.45070.1S R.45072.1S	R.45070.2S R.45072.2S	R.45070.1C R.45072.1C	R.45070.2C R.45072.2C	
<b>TRIBUTE</b>									
01-04		F R	R.65089	R.65089	R.65089.1S	R.65089.2S	R.65089.1C	R.65089.2C	
05-07	W/ REAR DRUM	F R	R.65089	R.65089	R.65089.1S	R.65089.2S	R.65089.1C	R.65089.2C	
05-07	W/ REAR DISC	F R	R.65107 R.65108	R.65107 R.65108	R.65107.1S R.65108.1S	R.65107.2S R.65108.2S	R.65107.1C R.65108.1C	R.65107.2C R.65108.2C	
08	2.3L (4 CYL.) W/ REAR DRUM	F R	R.65089	R.65089	R.65089.1S	R.65089.2S	R.65089.1C	R.65089.2C	
08	3.0L (V6) W/ REAR DRUM	F R	R.65107	R.65107	R.65107.1S	R.65107.2S	R.65107.1C	R.65107.2C	
<b>3</b>									
04-07	2000cc ENG	F R	R.45068 R.45066	R.45068 R.45066	R.45068.1S R.45066.1S	R.45068.2S R.45066.2S	R.45068.1C R.45066.1C	R.45068.2C R.45066.2C	
04-07	2300cc ENG	F R	R.45069 R.45067	R.45069 R.45067	R.45069.1S R.45067.1S	R.45069.2S R.45067.2S	R.45069.1C R.45067.1C	R.45069.2C R.45067.2C	
07	MAZDASPEED TURBO (2300cc)	F R	R.45078 R.45067	R.45078 R.45067	R.45078.1S R.45067.1S	R.45078.2S R.45067.2S	R.45078.1C R.45067.1C	R.45078.2C R.45067.2C	C
<b>5</b>									
06-07		F R	R.45069 R.45065	R.45069 R.45065	R.45069.1S R.45065.1S	R.45069.2S R.45065.2S	R.45069.1C R.45065.1C	R.45069.2C R.45065.2C	C
<b>6</b>									
03-05		F R	R.45063 R.45064	R.45063 R.45064	R.45063.1S R.45064.1S	R.45063.2S R.45064.2S	R.45063.1C R.45064.1C	R.45063.2C R.45064.2C	
06-07	EXC MAZDASPEED 6	F R	R.61088 R.45064	R.61088 R.45064	R.61088.1S R.45064.1S	R.61088.2S R.45064.2S	R.61088.1C R.45064.1C	R.61088.2C R.45064.2C	
06-07	MAZDASPEED 6	F R	R.45073 R.45074	R.45073 R.45074	R.45073.1S R.45074.1S	R.45073.2S R.45074.2S	R.45073.1C R.45074.1C	R.45073.2C R.45074.2C	C C
<b>626</b>									
93-97	W/ REAR DRUM	F R	R.45048	R.45048	R.45048.1S	R.45048.2S	R.45048.1C	R.45048.2C	
93-97	W/ REAR DISC	F R	R.45048 R.45049	R.45048 R.45049	R.45048.1S R.45049.1S	R.45048.2S R.45049.2S	R.45048.1C R.45049.1C	R.45048.2C R.45049.2C	
98-02	2.0L ENG	F R	R.45048	R.45048	R.45048.1S	R.45048.2S	R.45048.1C	R.45048.2C	
98-02	2.5L ENG	F R	R.45045 R.45057	R.45045 R.45057	R.45045.1S R.45057.1S	R.45045.2S R.45057.2S	R.45057.1C	R.45057.2C	

BRAKE DISC		BASIC OEM		SLOTTED		DRILLED & SLOTTED		NOTES
MAKE/MODEL	AXLE	PART #		PART #		PART #		
YEAR	F/R	LEFT	RIGHT	LEFT	RIGHT	LEFT	RIGHT	
<b>929, S</b>								
90-91	W/ ABS	F	R.45028	R.45028	R.45028.1S	R.45028.2S	R.45028.1C	R.45028.2C
		R	R.45042	R.45042	R.45042.1S	R.45042.2S	R.45042.1C	R.45042.2C
90-91	W/O ABS	F	R.45029	R.45029	R.45029.1S	R.45029.2S	R.45029.1C	R.45029.2C
		R	R.45042	R.45042	R.45042.1S	R.45042.2S	R.45042.1C	R.45042.2C
92-95		F	R.45045	R.45045	R.45045.1S	R.45045.2S		
		R	R.45046	R.45046	R.45046.1S	R.45046.2S	R.45046.1C	R.45046.2C
<b>MERCEDES-BENZ</b>								
<b>C32 AMG (W203)</b>								
02-04		F	R.35052	R.35052				D
		R	R.35048	R.35048	R.35048.1S	R.35048.2S	R.35048.1C	R.35048.2C
<b>C43 AMG (W202)</b>								
01-02		F						
		R	R.35048	R.35048	R.35048.1S	R.35048.2S	R.35048.1C	R.35048.2C
<b>C55 AMG (W203)</b>								
05-07		F	R.35052	R.35052				D
		R	R.35048	R.35048	R.35048.1S	R.35048.2S	R.35048.1C	R.35048.2C
<b>C220, C230 (W202, W203)</b>								
94-96		F	R.33043	R.33043	R.33043.1S	R.33043.2S	R.33043.1C	R.33043.2C
		R	R.35027	R.35027	R.35027.1S	R.35027.2S	R.35027.1C	R.35027.2C
97	W/ SOLID REAR DISC	F	R.35041	R.35041	R.35041.1S	R.35041.2S	R.35041.1C	R.35041.2C
		R	R.35027	R.35027	R.35027.1S	R.35027.2S	R.35027.1C	R.35027.2C
97	W/ VENTED REAR DISC	F	R.33043	R.33043	R.33043.1S	R.33043.2S	R.33043.1C	R.33043.2C
		R	R.35027	R.35027	R.35027.1S	R.35027.2S	R.35027.1C	R.35027.2C
98	W/ SOLID REAR DISC	F	R.35041	R.35041	R.35041.1S	R.35041.2S	R.35041.1C	R.35041.2C
		R	R.35027	R.35027	R.35027.1S	R.35027.2S	R.35027.1C	R.35027.2C
99-02		F	R.35057	R.35057	R.35057.1S	R.35057.2S	R.35057.1C	R.35057.2C
		R	R.35012	R.35012	R.35012.1S	R.35012.2S	R.35012.1C	R.35012.2C
03	EXC SPORT PKG	F	R.35057	R.35057	R.35057.1S	R.35057.2S	R.35057.1C	R.35057.2C
		R	R.35012	R.35012	R.35012.1S	R.35012.2S	R.35012.1C	R.35012.2C
03	W/ SPORT PKG	F	R.35058	R.35058	R.35058.1S	R.35058.2S		
		R	R.35034	R.35034	R.35034.1S	R.35034.2S	R.35034.1C	R.35034.2C
04	1 PISTON FRONT CALIPER	F	R.35057	R.35057	R.35057.1S	R.35057.2S	R.35057.1C	R.35057.2C
		R	R.35012	R.35012	R.35012.1S	R.35012.2S	R.35012.1C	R.35012.2C
04	4 PISTON FRONT CALIPER	F	R.35086	R.35086				D
		R	R.35034	R.35034	R.35034.1S	R.35034.2S	R.35034.1C	R.35034.2C
05-07		F	R.35086	R.35086				D
		R	R.35034	R.35034	R.35034.1S	R.35034.2S	R.35034.1C	R.35034.2C
<b>C240 SEDAN, WAGON (W203)</b>								
01-02	SEDAN	F	R.35057	R.35057	R.35057.1S	R.35057.2S	R.35057.1C	R.35057.2C
		R	R.35012	R.35012	R.35012.1S	R.35012.2S	R.35012.1C	R.35012.2C
03-05	SEDAN (EXC 4-MATIC AWD)	F	R.35057	R.35057	R.35057.1S	R.35057.2S	R.35057.1C	R.35057.2C
		R	R.35012	R.35012	R.35012.1S	R.35012.2S	R.35012.1C	R.35012.2C
03-05	SEDAN (4-MATIC AWD)	F	R.35058	R.35058	R.35058.1S	R.35058.2S		
		R	R.35034	R.35034	R.35034.1S	R.35034.2S	R.35034.1C	R.35034.2C
03-05	WAGON (EXC 4-MATIC AWD)	F	R.35057	R.35057	R.35057.1S	R.35057.2S	R.35057.1C	R.35057.2C
		R	R.35034	R.35034	R.35034.1S	R.35034.2S	R.35034.1C	R.35034.2C
03-05	WAGON (4-MATIC AWD)	F	R.35058	R.35058	R.35058.1S	R.35058.2S		
		R	R.35034	R.35034	R.35034.1S	R.35034.2S	R.35034.1C	R.35034.2C
<b>C280 (W202)</b>								
94-95		F	R.33043	R.33043	R.33043.1S	R.33043.2S	R.33043.1C	R.33043.2C
		R	R.35027	R.35027	R.35027.1S	R.35027.2S	R.35027.1C	R.35027.2C
96-00		F	R.35032	R.35032	R.35032.1S	R.35032.2S	R.35032.1C	R.35032.2C
		R	R.35012	R.35012	R.35012.1S	R.35012.2S	R.35012.1C	R.35012.2C
06-07		F	R.35058	R.35058	R.35058.1S	R.35058.2S		
		R	R.35034	R.35034	R.35034.1S	R.35034.2S	R.35034.1C	R.35034.2C
<b>C320, C350 SEDAN, WAGON (W203)</b>								
01-05	EXC SPORT SEDAN	F	R.35058	R.35058	R.35058.1S	R.35058.2S		
		R	R.35034	R.35034	R.35034.1S	R.35034.2S	R.35034.1C	R.35034.2C
03-05	SPORT SEDAN	F	R.35086	R.35086				D
		R	R.35034	R.35034	R.35034.1S	R.35034.2S	R.35034.1C	R.35034.2C
06-07	EXC 2-PISTON FRONT CALIPER	F	R.35058	R.35058	R.35058.1S	R.35058.2S		
		R	R.35034	R.35034	R.35034.1S	R.35034.2S	R.35034.1C	R.35034.2C
<b>CL55 AMG (W215)</b>								
03-06		F	R.35066	R.35066				D
		R	R.35067	R.35067				D
<b>CL500 (W140, W215)</b>								

BRAKE DISC		BASIC OEM		SLOTTED		DRILLED & SLOTTED		
MAKE/MODEL	AXLE	PART #		PART #		PART #		NOTES
YEAR	F/R	LEFT	RIGHT	LEFT	RIGHT	LEFT	RIGHT	
98-99	F	R.35023	R.35023	R.35023.1S	R.35023.2S	R.35023.1C	R.35023.2C	A
	R	R.35024	R.35024	R.35024.1S	R.35024.2S	R.35024.1C	R.35024.2C	A
00-03	F	R.35038	R.35038	R.35039.1S	R.35039.2S	R.35039.1C	R.35039.2C	D
	R	R.35039	R.35039					A
<b>CL600 (W140)</b>								
98-99	F	R.35023	R.35023	R.35023.1S	R.35023.2S	R.35023.1C	R.35023.2C	A
	R	R.35024	R.35024	R.35024.1S	R.35024.2S	R.35024.1C	R.35024.2C	A
<b>CLK320, CLK350 (W208, W209)</b>								
98-07	F	R.35058	R.35058	R.35058.1S	R.35058.2S			
	R	R.35034	R.35034	R.35034.1S	R.35034.2S	R.35034.1C	R.35034.2C	A
<b>CLK430 (W208), CLK500, CLK550 (W209)</b>								
99-02	F	R.35058	R.35058	R.35058.1S	R.35058.2S			
	R	R.35034	R.35034	R.35034.1S	R.35034.2S	R.35034.1C	R.35034.2C	A
03	F	R.35058	R.35058	R.35058.1S	R.35058.2S			
CLK430	R	R.35034	R.35034	R.35034.1S	R.35034.2S	R.35034.1C	R.35034.2C	A
03	F	R.35052	R.35052					D
CLK500	R	R.35048	R.35048	R.35048.1S	R.35048.2S	R.35048.1C	R.35048.2C	A
04-07	F	R.35052	R.35052					D
	R	R.35048	R.35048	R.35048.1S	R.35048.2S	R.35048.1C	R.35048.2C	A
<b>CLS55 AMG (219)</b>								
05	F	R.35068	R.35068					D
	R	R.35077	R.35077					D
<b>E55 AMG (W210, W211)</b>								
03-06	F	R.35068	R.35068					D
	R	R.35077	R.35077					D
<b>E300 DIESEL, TURBODIESEL (W124, W210)</b>								
94-95	F	R.35015	R.35015	R.35015.1S	R.35015.2S	R.35015.1C	R.35015.2C	A
	R	R.35014	R.35014	R.35014.1S	R.35014.2S	R.35014.1C	R.35014.2C	A
96-97	F	R.35057	R.35057	R.35057.1S	R.35057.2S	R.35057.1C	R.35057.2C	A
	R	R.35012	R.35012	R.35012.1S	R.35012.2S	R.35012.1C	R.35012.2C	A
98-00	F	R.35058	R.35058	R.35058.1S	R.35058.2S			
	R	R.35034	R.35034	R.35034.1S	R.35034.2S	R.35034.1C	R.35034.2C	A
<b>E320 COUPE, CABRIOLET, SEDAN (W124, W210, W211)</b>								
94-95	F	R.35031	R.35031	R.35031.1S	R.35031.2S	R.35031.1C	R.35031.2C	A
	R	R.35026	R.35026	R.35026.1S	R.35026.2S	R.35026.1C	R.35026.2C	A
96-02	F	R.35058	R.35058	R.35058.1S	R.35058.2S			
	R	R.35034	R.35034	R.35034.1S	R.35034.2S	R.35034.1C	R.35034.2C	A
03	F	R.35060	R.35060	R.35060.1S	R.35060.2S	R.35060.1C	R.35060.2C	A
	R	R.35061	R.35061	R.35061.1S	R.35061.2S	R.35061.1C	R.35061.2C	A
04-05	F	R.35060	R.35060	R.35060.1S	R.35060.2S	R.35060.1C	R.35060.2C	A
EXC 4-MATIC AWD	R	R.35061	R.35061	R.35061.1S	R.35061.2S	R.35061.1C	R.35061.2C	A
04-05	F							
4-MATIC AWD	R	R.35061	R.35061	R.35061.1S	R.35061.2S	R.35061.1C	R.35061.2C	A
06	F	R.35060	R.35060	R.35060.1S	R.35060.2S	R.35060.1C	R.35060.2C	A
E320	R	R.35061	R.35061	R.35061.1S	R.35061.2S	R.35061.1C	R.35061.2C	A
06	F	R.35062	R.35062	R.35062.1S	R.35062.2S	R.35062.1C	R.35062.2C	A
E350 (EXC 4-MATIC AWD)	R	R.35061	R.35061	R.35061.1S	R.35061.2S	R.35061.1C	R.35061.2C	A
06	F	R.35060	R.35060	R.35060.1S	R.35060.2S	R.35060.1C	R.35060.2C	A
E350 (EXC 4-MATIC AWD)	R	R.35063	R.35063	R.35063.1S	R.35063.2S	R.35063.1C	R.35063.2C	A
06	F							
E350 (4-MATIC AWD)	R	R.35063	R.35063	R.35063.1S	R.35063.2S	R.35063.1C	R.35063.2C	A
07	F	R.35060	R.35060	R.35060.1S	R.35060.2S	R.35060.1C	R.35060.2C	A
E350 (EXC 4-MATIC AWD)	R	R.35063	R.35063	R.35063.1S	R.35063.2S	R.35063.1C	R.35063.2C	A
07	F							
SPORT SEDAN	R	R.35063	R.35063	R.35063.1S	R.35063.2S	R.35063.1C	R.35063.2C	A
07	F							
EXC 4-MATIC AWD	R	R.35063	R.35063	R.35063.1S	R.35063.2S	R.35063.1C	R.35063.2C	A
07	F							
4-MATIC	R	R.35063	R.35063	R.35063.1S	R.35063.2S	R.35063.1C	R.35063.2C	A
<b>E320, E350 WAGON (W124, W210, W211)</b>								
94-95	F	R.35031	R.35031	R.35031.1S	R.35031.2S	R.35031.1C	R.35031.2C	A
	R	R.35034	R.35034	R.35034.1S	R.35034.2S	R.35034.1C	R.35034.2C	A
98-03	F	R.35058	R.35058	R.35058.1S	R.35058.2S			
	R	R.35044	R.35044	R.35044.1S	R.35044.2S	R.35044.1C	R.35044.2C	A
04-05	F	R.35060	R.35060	R.35060.1S	R.35060.2S	R.35060.1C	R.35060.2C	A
EXC 4-MATIC AWD	R	R.35063	R.35063	R.35063.1S	R.35063.2S	R.35063.1C	R.35063.2C	A
04-05	F							
4-MATIC AWD	R	R.35063	R.35063	R.35063.1S	R.35063.2S	R.35063.1C	R.35063.2C	A
06	F	R.35062	R.35062	R.35062.1S	R.35062.2S	R.35062.1C	R.35062.2C	A
E350 (EXC 4-MATIC AWD)	R	R.35063	R.35063	R.35063.1S	R.35063.2S	R.35063.1C	R.35063.2C	A

BRAKE DISC		BASIC OEM		SLOTTED		DRILLED & SLOTTED			
MAKE/MODEL	AXLE	PART #		PART #		PART #		NOTES	
YEAR	F/R	LEFT	RIGHT	LEFT	RIGHT	LEFT	RIGHT		
06	E350 (EXC 4-MATIC AWD)	F	R.35060	R.35060	R.35060.1S	R.35060.2S	R.35060.1C	R.35060.2C	A
		R	R.35063	R.35063	R.35063.1S	R.35063.2S	R.35063.1C	R.35063.2C	A
06	E350 (4-MATIC AWD)	F							
		R	R.35063	R.35063	R.35063.1S	R.35063.2S	R.35063.1C	R.35063.2C	A
07	4-MATIC	F							
		R	R.35063	R.35063	R.35063.1S	R.35063.2S	R.35063.1C	R.35063.2C	A
<b>E500, E550 (W124, W211)</b>									
94-95		F	R.35031	R.35031	R.35031.1S	R.35031.2S	R.35031.1C	R.35031.2C	A
		R	R.35026	R.35026	R.35026.1S	R.35026.2S	R.35026.1C	R.35026.2C	A
97-99		F	R.35058	R.35058	R.35058.1S	R.35058.2S			
		R	R.35034	R.35034	R.35034.1S	R.35034.2S	R.35034.1C	R.35034.2C	A
00-02		F	R.35058	R.35058	R.35058.1S	R.35058.2S			
		R	R.35034	R.35034	R.35034.1S	R.35034.2S	R.35034.1C	R.35034.2C	A
00-02		F	R.35054	R.35054	R.35054.1S	R.35054.2S	R.35054.1C	R.35054.2C	A
		R	R.35048	R.35048	R.35048.1S	R.35048.2S	R.35048.1C	R.35048.2C	A
<b>E500, E550 (W211)</b>									
03		F	R.35062	R.35062	R.35062.1S	R.35062.2S	R.35062.1C	R.35062.2C	A
		R	R.35063	R.35063	R.35063.1S	R.35063.2S	R.35063.1C	R.35063.2C	A
04-07	EXC 4-MATIC AWD W/ SOLID REAR DISC	F	R.35062	R.35062	R.35062.1S	R.35062.2S	R.35062.1C	R.35062.2C	A
		R	R.35061	R.35061	R.35061.1S	R.35061.2S	R.35061.1C	R.35061.2C	A
04-07	EXC 4-MATIC AWD W/ VENTED REAR DISC	F	R.35060	R.35060	R.35060.1S	R.35060.2S	R.35060.1C	R.35060.2C	A
		R	R.35063	R.35063	R.35063.1S	R.35063.2S	R.35063.1C	R.35063.2C	A
04-07	4-MATIC AWD	F							
		R	R.35063	R.35063	R.35063.1S	R.35063.2S	R.35063.1C	R.35063.2C	A
<b>G500, 55 AMG (BM463)</b>									
02-05	REAR AXLE#: R119848	F	R.35056	R.35056	R.35056.1S	R.35056.2S	R.35056.1C	R.35056.2C	A
		R	R.35045	R.35045	R.35045.1S	R.35045.2S	R.35045.1C	R.35045.2C	A
02-05	REAR AXLE#: R119849	F	R.35056	R.35056	R.35056.1S	R.35056.2S	R.35056.1C	R.35056.2C	A
		R	R.35070	R.35070	R.35070.1S	R.35070.2S	R.35070.1C	R.35070.2C	A
<b>GL450 (W164)</b>									
07		F	R.35091	R.35091	R.35091.1S	R.35091.2S	R.35091.1C	R.35091.2C	A
		R	R.35092	R.35092	R.35092.1S	R.35092.2S	R.35092.1C	R.35092.2C	A
<b>ML55 AMG (W163)</b>									
00-03		F	R.35042	R.35042	R.35042.1S	R.35042.2S	R.35042.1C	R.35042.2C	A
		R	R.35043	R.35043	R.35043.1S	R.35043.2S	R.35043.1C	R.35043.2C	A
<b>ML320, ML350 (W163, W164)</b>									
98-05		F	R.35036	R.35036	R.35036.1S	R.35036.2S	R.35036.1C	R.35036.2C	A
		R	R.35037	R.35037	R.35037.1S	R.35037.2S	R.35037.1C	R.35037.2C	A
06-07		F	R.35089	R.35089	R.35089.1S	R.35089.2S	R.35089.1C	R.35089.2C	A
		R	R.35090	R.35090	R.35090.1S	R.35090.2S	R.35090.1C	R.35090.2C	A
<b>ML430, ML500 (W163, W164)</b>									
98-99	W163	F	R.35036	R.35036	R.35036.1S	R.35036.2S	R.35036.1C	R.35036.2C	A
		R	R.35037	R.35037	R.35037.1S	R.35037.2S	R.35037.1C	R.35037.2C	A
00-05	W163	F	R.35042	R.35042	R.35042.1S	R.35042.2S	R.35042.1C	R.35042.2C	A
		R	R.35043	R.35043	R.35043.1S	R.35043.2S	R.35043.1C	R.35043.2C	A
06-07	W164	F	R.35089	R.35089	R.35089.1S	R.35089.2S	R.35089.1C	R.35089.2C	A
		R	R.35092	R.35092	R.35092.1S	R.35092.2S	R.35092.1C	R.35092.2C	A
06-07	W164	F	R.35091	R.35091	R.35091.1S	R.35091.2S	R.35091.1C	R.35091.2C	A
		R	R.35092	R.35092	R.35092.1S	R.35092.2S	R.35092.1C	R.35092.2C	A
<b>R320, R350, R500 (W251)</b>									
06-07	R320, R350	F	R.35089	R.35089	R.35089.1S	R.35089.2S	R.35089.1C	R.35089.2C	A
		R	R.35090	R.35090	R.35090.1S	R.35090.2S	R.35090.1C	R.35090.2C	A
06-07	R500	F	R.35091	R.35091	R.35091.1S	R.35091.2S	R.35091.1C	R.35091.2C	A
		R	R.35092	R.35092	R.35092.1S	R.35092.2S	R.35092.1C	R.35092.2C	A
<b>S55 AMG (W220)</b>									
03-06		F	R.35066	R.35066					D
		R	R.35067	R.35067					D
<b>S320, 350 (W140)</b>									
94-99	GIRLING FRONT CALIPER	F	R.35023	R.35023	R.35023.1S	R.35023.2S	R.35023.1C	R.35023.2C	A
		R	R.35022	R.35022	R.35022.1S	R.35022.2S	R.35022.1C	R.35022.2C	
<b>S420, S430 (W140, W220)</b>									
94-99	W140	F	R.35023	R.35023	R.35023.1S	R.35023.2S	R.35023.1C	R.35023.2C	A
		R	R.35024	R.35024	R.35024.1S	R.35024.2S	R.35024.1C	R.35024.2C	A
00-9/2/02	W220	F	R.35038	R.35038					D
		R	R.35039	R.35039	R.35039.1S	R.35039.2S	R.35039.1C	R.35039.2C	A
9/3/02-06	EXC 4-MATIC AWD	F							
		R	R.35039	R.35039	R.35039.1S	R.35039.2S	R.35039.1C	R.35039.2C	A
9/3/02-06	4-MATIC AWD	F							



BRAKE DISC		BASIC OEM		SLOTTED		DRILLED & SLOTTED		NOTES
MAKE/MODEL	AXLE	PART #		PART #		PART #		
YEAR	F/R	LEFT	RIGHT	LEFT	RIGHT	LEFT	RIGHT	
	R	R.35039	R.35039	R.35039.1S	R.35039.2S	R.35039.1C	R.35039.2C	A
<b>S500 (W140, W220)</b>								
94-99	F	R.35023	R.35023	R.35023.1S	R.35023.2S	R.35023.1C	R.35023.2C	A
	R	R.35024	R.35024	R.35024.1S	R.35024.2S	R.35024.1C	R.35024.2C	A
00-9/02	F	R.35038	R.35038					D
	R	R.35039	R.35039	R.35039.1S	R.35039.2S	R.35039.1C	R.35039.2C	A
<b>S600 (W140)</b>								
94-99	F	R.35023	R.35023	R.35023.1S	R.35023.2S	R.35023.1C	R.35023.2C	A
	R	R.35024	R.35024	R.35024.1S	R.35024.2S	R.35024.1C	R.35024.2C	A
<b>SL55 AMG (R230)</b>								
03-05	F	R.35068	R.35068					D
	R	R.35076	R.35076					D
06-07	F							
	R	R.35076	R.35076					D
<b>SL320, SL500, SL550 (R129, R230)</b>								
94-95	F	R.35019	R.35019	R.35019.1S	R.35019.2S	R.35019.1C	R.35019.2C	
	R	R.35018	R.35018	R.35018.1S	R.35018.2S	R.35018.1C	R.35018.2C	
96-98	F	R.35019	R.35019	R.35019.1S	R.35019.2S	R.35019.1C	R.35019.2C	
	R	R.35040	R.35040	R.35040.1S	R.35040.2S	R.35040.1C	R.35040.2C	
96-98	F							
	R	R.35030	R.35030	R.35030.1S	R.35030.2S	R.35030.1C	R.35030.2C	
99-02	F	R.35046	R.35046	R.35046.1S	R.35046.2S	R.35046.1C	R.35046.2C	
	R	R.35030	R.35030	R.35030.1S	R.35030.2S	R.35030.1C	R.35030.2C	
05-06	F	R.35062	R.35062	R.35062.1S	R.35062.2S	R.35062.1C	R.35062.2C	A
	R							
<b>SL600 (R129, R230)</b>								
94-02	F	R.35046	R.35046	R.35046.1S	R.35046.2S	R.35046.1C	R.35046.2C	
	R	R.35030	R.35030	R.35030.1S	R.35030.2S	R.35030.1C	R.35030.2C	
04-06	F	R.35068	R.35068					D
	R	R.35076	R.35076					D
<b>SLK32 AMG (R170)</b>								
01-04	F	R.35054	R.35054	R.35054.1S	R.35054.2S	R.35054.1C	R.35054.2C	A
	R	R.35048	R.35048	R.35048.1S	R.35048.2S	R.35048.1C	R.35048.2C	A
<b>SLK230, SLK280, SLK320, SLK350 (R170, R171)</b>								
98-01	F	R.35058	R.35058	R.35058.1S	R.35058.2S	R.35058.1C	R.35058.2C	
	R	R.35012	R.35012	R.35012.1S	R.35012.2S	R.35012.1C	R.35012.2C	A
02-04	F	R.35057	R.35057	R.35057.1S	R.35057.2S	R.35057.1C	R.35057.2C	A
	R	R.35012	R.35012	R.35012.1S	R.35012.2S	R.35012.1C	R.35012.2C	A
02-04	F	R.35058	R.35058	R.35058.1S	R.35058.2S			
	R	R.35012	R.35012	R.35012.1S	R.35012.2S	R.35012.1C	R.35012.2C	A
05-07	F	R.35086	R.35086					D
	R	R.35034	R.35034	R.35034.1S	R.35034.2S	R.35034.1C	R.35034.2C	A
07	F	R.35058	R.35058	R.35058.1S	R.35058.2S			
	R	R.35012	R.35012	R.35012.1S	R.35012.2S	R.35012.1C	R.35012.2C	A
<b>MERCURY</b>								
<b>COUGAR</b>								
91-92	F	R.61051	R.61051	R.61051.1S	R.61051.2S	R.61051.1C	R.61051.2C	
	R							
91-92	F	R.61051	R.61051	R.61051.1S	R.61051.2S	R.61051.1C	R.61051.2C	
	R	R.61019	R.61019	R.61019.1S	R.61019.2S	R.61019.1C	R.61019.2C	
93-95	F	R.61051	R.61051	R.61051.1S	R.61051.2S	R.61051.1C	R.61051.2C	
	R							
93-95	F	R.61051	R.61051	R.61051.1S	R.61051.2S	R.61051.1C	R.61051.2C	
	R	R.61037	R.61037	R.61037.1S	R.61037.2S	R.61037.1C	R.61037.2C	
96-97	F	R.61051	R.61051	R.61051.1S	R.61051.2S	R.61051.1C	R.61051.2C	
	R							
96-97	F	R.61051	R.61051	R.61051.1S	R.61051.2S	R.61051.1C	R.61051.2C	
	R	R.61037	R.61037	R.61037.1S	R.61037.2S	R.61037.1C	R.61037.2C	
96-97	F	R.61049	R.61049	R.61049.1S	R.61049.2S	R.61049.1C	R.61049.2C	
	R	R.61037	R.61037	R.61037.1S	R.61037.2S	R.61037.1C	R.61037.2C	
99-04	F	R.61048	R.61048	R.61048.1S	R.61048.2S	R.61048.1C	R.61048.2C	
	R							
99-04	F	R.61048	R.61048	R.61048.1S	R.61048.2S	R.61048.1C	R.61048.2C	
	R	R.61050	R.61050	R.61050.1S	R.61050.2S	R.61050.1C	R.61050.2C	
99-04	F	R.61056	R.61056	R.61056.1S	R.61056.2S	R.61056.1C	R.61056.2C	
	R	R.61050	R.61050	R.61050.1S	R.61050.2S	R.61050.1C	R.61050.2C	
<b>MARAUDER</b>								

BRAKE DISC		BASIC OEM		SLOTTED		DRILLED & SLOTTED		NOTES
MAKE/MODEL	AXLE	PART #		PART #		PART #		
YEAR	F/R	LEFT	RIGHT	LEFT	RIGHT	LEFT	RIGHT	
03-04	F	R.61072	R.61072	R.61072.1S	R.61072.2S	R.61072.1C	R.61072.2C	
	R	R.61073	R.61073	R.61073.1S	R.61073.2S	R.61073.1C	R.61073.2C	
<b>MARINER</b>								
05-08	W/ REAR DRUM	F	R.65089	R.65089	R.65089.1S	R.65089.2S	R.65089.1C	R.65089.2C
		R						
05-08	W/ REAR DISC	F	R.65107	R.65107	R.65107.1S	R.65107.2S	R.65107.1C	R.65107.2C
		R	R.65108	R.65108	R.65108.1S	R.65108.2S	R.65108.1C	R.65108.2C
<b>MILAN</b>								
06		F	R.61088	R.61088	R.61088.1S	R.61088.2S	R.61088.1C	R.61088.2C
		R	R.45064	R.45064	R.45064.1S	R.45064.2S	R.45064.1C	R.45064.2C
<b>MONTEGO</b>								
05-07		F	R.61080	R.61080	R.61080.1S	R.61080.2S	R.61080.1C	R.61080.2C
		R	R.61081	R.61081	R.61081.1S	R.61081.2S	R.61081.1C	R.61081.2C
<b>MONTEREY</b>								
04-07		F	R.61078	R.61078	R.61078.1S	R.61078.2S	R.61078.1C	R.61078.2C
		R	R.61079	R.61079	R.61079.1S	R.61079.2S	R.61079.1C	R.61079.2C
<b>MOUNTAINEER</b>								
97-01	2WD	F	R.65051	R.65051	R.65051.1S	R.65051.2S	R.65051.1C	R.65051.2C
		R	R.65052	R.65052	R.65052.1S	R.65052.2S	R.65052.1C	R.65052.2C
97-01	4WD	F	R.65054	R.65054	R.65054.1S	R.65054.2S	R.65054.1C	R.65054.2C
		R	R.65052	R.65052	R.65052.1S	R.65052.2S	R.65052.1C	R.65052.2C
02-05		F	R.65091	R.65091	R.65091.1S	R.65091.2S	R.65091.1C	R.65091.2C
		R	R.65090	R.65090	R.65090.1S	R.65090.2S	R.65090.1C	R.65090.2C
06-07		F	R.65118	R.65118	R.65118.1S	R.65118.2S	R.65118.1C	R.65118.2C
		R	R.65090	R.65090	R.65090.1S	R.65090.2S	R.65090.1C	R.65090.2C
<b>MYSTIQUE</b>								
95-00	W/ REAR DRUM	F	R.61048	R.61048	R.61048.1S	R.61048.2S	R.61048.1C	R.61048.2C
		R						
95-00	W/ REAR DISC	F	R.61048	R.61048	R.61048.1S	R.61048.2S	R.61048.1C	R.61048.2C
		R	R.61050	R.61050	R.61050.1S	R.61050.2S	R.61050.1C	R.61050.2C
<b>SABLE</b>								
90-1/91	W/ REAR DRUM	F	R.61022	R.61022	R.61022.1S	R.61022.2S	R.61022.1C	R.61022.2C
		R						
90-1/91	W/ REAR DISC	F	R.61022	R.61022	R.61022.1S	R.61022.2S	R.61022.1C	R.61022.2C
		R	R.61036	R.61036	R.61036.1S	R.61036.2S	R.61036.1C	R.61036.2C
2/91-92	W/ REAR DRUM	F	R.61033	R.61033	R.61033.1S	R.61033.2S	R.61033.1C	R.61033.2C
		R						
2/91-92	W/ REAR DISC	F	R.61033	R.61033	R.61033.1S	R.61033.2S	R.61033.1C	R.61033.2C
		R	R.61036	R.61036	R.61036.1S	R.61036.2S	R.61036.1C	R.61036.2C
93	W/ REAR DRUM	F	R.61033	R.61033	R.61033.1S	R.61033.2S	R.61033.1C	R.61033.2C
		R						
93	W/ REAR DISC	F	R.61033	R.61033	R.61033.1S	R.61033.2S	R.61033.1C	R.61033.2C
		R	R.61039	R.61039	R.61039.1S	R.61039.2S	R.61039.1C	R.61039.2C
94-00	W/ REAR DRUM	F	R.65051	R.65051	R.65051.1S	R.65051.2S	R.65051.1C	R.65051.2C
		R						
94-00	W/ REAR DISC	F	R.65051	R.65051	R.65051.1S	R.65051.2S	R.65051.1C	R.65051.2C
		R	R.61039	R.61039	R.61039.1S	R.61039.2S	R.61039.1C	R.61039.2C
01-05	W/ REAR DRUM	F	R.61049	R.61049	R.61049.1S	R.61049.2S	R.61049.1C	R.61049.2C
		R						
01-05	W/ REAR DISC	F	R.61049	R.61049	R.61049.1S	R.61049.2S	R.61049.1C	R.61049.2C
		R	R.61039	R.61039	R.61039.1S	R.61039.2S	R.61039.1C	R.61039.2C
<b>MINI</b>								
<b>COOPER, COOPER S</b>								
02-05		F	R.34067	R.34067	R.34067.1S	R.34067.2S	R.34067.1C	R.34067.2C
		R	R.34066	R.34066	R.34066.1S	R.34066.2S	R.34066.1C	R.34066.2C
06	W/O COOPER WORKS	F	R.34067	R.34067	R.34067.1S	R.34067.2S	R.34067.1C	R.34067.2C
		R	R.34066	R.34066	R.34066.1S	R.34066.2S	R.34066.1C	R.34066.2C
06	W/ COOPER WORKS	F						
		R	R.34066	R.34066	R.34066.1S	R.34066.2S	R.34066.1C	R.34066.2C
<b>MINI</b>								
<b>DIAMANTE</b>								
92-96	SEDAN	F	R.46032	R.46032	R.46032.1S	R.46032.2S	R.46032.1C	R.46032.2C
		R	R.46033	R.46033	R.46033.1S	R.46033.2S	R.46033.1C	R.46033.2C
97-04		F	R.46032	R.46032	R.46032.1S	R.46032.2S	R.46032.1C	R.46032.2C
		R	R.46050	R.46050	R.46050.1S	R.46050.2S	R.46050.1C	R.46050.2C
<b>ECLIPSE (EXC TURBO)</b>								

MAKE/MODEL		AXLE	BASIC OEM		SLOTTED		DRILLED & SLOTTED		NOTES
			PART #		PART #		PART #		
YEAR		F/R	LEFT	RIGHT	LEFT	RIGHT	LEFT	RIGHT	
4/89-93		F	R.46042	R.46042	R.46042.1S	R.46042.2S	R.46042.1C	R.46042.2C	
		R	R.46028	R.46028	R.46028.1S	R.46028.2S	R.46028.1C	R.46028.2C	
94-99	W/ REAR DRUM	F	R.46042	R.46042	R.46042.1S	R.46042.2S	R.46042.1C	R.46042.2C	
		R							
94-99	W/ REAR DISC	F	R.46042	R.46042	R.46042.1S	R.46042.2S	R.46042.1C	R.46042.2C	
		R	R.46047	R.46047	R.46047.1S	R.46047.2S	R.46047.1C	R.46047.2C	
00	4 CYL.	F	R.46042	R.46042	R.46042.1S	R.46042.2S	R.46042.1C	R.46042.2C	
		R							
00	V6	F	R.46032	R.46032	R.46032.1S	R.46032.2S	R.46032.1C	R.46032.2C	
		R	R.46047	R.46047	R.46047.1S	R.46047.2S	R.46047.1C	R.46047.2C	
01	4 CYL.	F	R.46042	R.46042	R.46042.1S	R.46042.2S	R.46042.1C	R.46042.2C	
		R							
01	V6	F	R.46061	R.46061	R.46061.1S	R.46061.2S	R.46061.1C	R.46061.2C	
		R	R.46047	R.46047	R.46047.1S	R.46047.2S	R.46047.1C	R.46047.2C	
02-05	4 CYL.	F	R.46061	R.46061	R.46061.1S	R.46061.2S	R.46061.1C	R.46061.2C	
		R							
02-05	V6	F	R.46061	R.46061	R.46061.1S	R.46061.2S	R.46061.1C	R.46061.2C	
		R	R.46047	R.46047	R.46047.1S	R.46047.2S	R.46047.1C	R.46047.2C	
06-07	GS (4 CYL.)	F	R.46068	R.46068	R.46068.1S	R.46068.2S	R.46068.1C	R.46068.2C	
		R	R.46069	R.46069	R.46069.1S	R.46069.2S	R.46069.1C	R.46069.2C	
06-07	GT (6 CYL.)	F	R.46068	R.46068	R.46068.1S	R.46068.2S	R.46068.1C	R.46068.2C	
		R	R.46072	R.46072	R.46072.1S	R.46072.2S	R.46072.1C	R.46072.2C	
<b>ECLIPSE TURBO (2WD)</b>									
4/89-93		F	R.46042	R.46042	R.46042.1S	R.46042.2S	R.46042.1C	R.46042.2C	
		R	R.46028	R.46028	R.46028.1S	R.46028.2S	R.46028.1C	R.46028.2C	
94-99		F	R.46042	R.46042	R.46042.1S	R.46042.2S	R.46042.1C	R.46042.2C	
		R	R.46047	R.46047	R.46047.1S	R.46047.2S	R.46047.1C	R.46047.2C	
<b>ECLIPSE TURBO (4WD)</b>									
4/89-5/92		F	R.46042	R.46042	R.46042.1S	R.46042.2S	R.46042.1C	R.46042.2C	
		R	R.46028	R.46028	R.46028.1S	R.46028.2S	R.46028.1C	R.46028.2C	
6/92-93		F	R.46032	R.46032	R.46032.1S	R.46032.2S	R.46032.1C	R.46032.2C	
		R	R.46028	R.46028	R.46028.1S	R.46028.2S	R.46028.1C	R.46028.2C	
94-10/94		F	R.46032	R.46032	R.46032.1S	R.46032.2S	R.46032.1C	R.46032.2C	
		R	R.46048	R.46048	R.46048.1S	R.46048.2S	R.46048.1C	R.46048.2C	
11/94-99		F	R.46032	R.46032	R.46032.1S	R.46032.2S	R.46032.1C	R.46032.2C	
		R	R.46047	R.46047	R.46047.1S	R.46047.2S	R.46047.1C	R.46047.2C	
<b>GALANT (EXC SIGMA)</b>									
11/89-1/93	W/ REAR DRUM	F	R.46019	R.46019	R.46019.1S	R.46019.2S	R.46019.1C	R.46019.2C	
		R							
11/89-1/93	W/ REAR DISC	F	R.46019	R.46019	R.46019.1S	R.46019.2S	R.46019.1C	R.46019.2C	
		R	R.46024	R.46024	R.46024.1S	R.46024.2S	R.46024.1C	R.46024.2C	
6/90-1/93	AWD TURBO	F	R.46035	R.46035	R.46035.1S	R.46035.2S	R.46035.1C	R.46035.2C	
		R	R.46024	R.46024	R.46024.1S	R.46024.2S	R.46024.1C	R.46024.2C	
2/93-1/98	W/ REAR DRUM	F	R.46019	R.46019	R.46019.1S	R.46019.2S	R.46019.1C	R.46019.2C	
		R							
2/93-1/98	W/ REAR DISC	F	R.46019	R.46019	R.46019.1S	R.46019.2S	R.46019.1C	R.46019.2C	
		R	R.46038	R.46038	R.46038.1S	R.46038.2S	R.46038.1C	R.46038.2C	
2/98-5/00	4 CYL.	F	R.46042	R.46042	R.46042.1S	R.46042.2S	R.46042.1C	R.46042.2C	
		R							
2/98-5/00	V6	F	R.46032	R.46032	R.46032.1S	R.46032.2S	R.46032.1C	R.46032.2C	
		R	R.46047	R.46047	R.46047.1S	R.46047.2S	R.46047.1C	R.46047.2C	
6/00-01	4 CYL.	F	R.46042	R.46042	R.46042.1S	R.46042.2S	R.46042.1C	R.46042.2C	
		R	R.46047	R.46047	R.46047.1S	R.46047.2S	R.46047.1C	R.46047.2C	
6/00-01	V6	F	R.46061	R.46061	R.46061.1S	R.46061.2S	R.46061.1C	R.46061.2C	
		R	R.46047	R.46047	R.46047.1S	R.46047.2S	R.46047.1C	R.46047.2C	
02-03	4 CYL.	F	R.46061	R.46061	R.46061.1S	R.46061.2S	R.46061.1C	R.46061.2C	
		R							
02-03	V6	F	R.46061	R.46061	R.46061.1S	R.46061.2S	R.46061.1C	R.46061.2C	
		R	R.46047	R.46047	R.46047.1S	R.46047.2S	R.46047.1C	R.46047.2C	
04-07	4 CYL. (2.4L)	F	R.46061	R.46061	R.46061.1S	R.46061.2S	R.46061.1C	R.46061.2C	
		R	R.46069	R.46069	R.46069.1S	R.46069.2S	R.46069.1C	R.46069.2C	
04-07	V6 (3.8L), EXC RALLIART	F	R.46068	R.46068	R.46068.1S	R.46068.2S	R.46068.1C	R.46068.2C	
		R	R.46069	R.46069	R.46069.1S	R.46069.2S	R.46069.1C	R.46069.2C	
04-07	V6 (3.8L), 07 RALLIART	F	R.46068	R.46068	R.46068.1S	R.46068.2S	R.46068.1C	R.46068.2C	
		R	R.46072	R.46072	R.46072.1S	R.46072.2S	R.46072.1C	R.46072.2C	
<b>GALANT SIGMA</b>									
88-90		F	R.46019	R.46019	R.46019.1S	R.46019.2S	R.46019.1C	R.46019.2C	
		R	R.46022	R.46022	R.46022.1S	R.46022.2S	R.46022.1C	R.46022.2C	

MAKE/MODEL		AXLE	BASIC OEM		SLOTTED		DRILLED & SLOTTED		NOTES
			PART #		PART #		PART #		
YEAR		F/R	LEFT	RIGHT	LEFT	RIGHT	LEFT	RIGHT	
<b>LANCER (EXC EVOLUTION)</b>									
02-03	ES	F	R.46060	R.46060	R.46060.1S	R.46060.2S	R.46060.1C	R.46060.2C	
		R							
02-03	LS	F	R.46019	R.46019	R.46019.1S	R.46019.2S	R.46019.1C	R.46019.2C	
		R							
02-03	O-Z RALLY EDITION	F	R.46019	R.46019	R.46019.1S	R.46019.2S	R.46019.1C	R.46019.2C	
		R							
04	ES	F	R.46060	R.46060	R.46060.1S	R.46060.2S	R.46060.1C	R.46060.2C	
		R							
04	LS	F	R.46039	R.46039	R.46039.1S	R.46039.2S	R.46039.1C	R.46039.2C	
		R							
04	O-Z RALLY EDITION	F	R.46039	R.46039	R.46039.1S	R.46039.2S	R.46039.1C	R.46039.2C	
		R							
04	RALLIART (5 LUG)	F	R.46061	R.46061	R.46061.1S	R.46061.2S	R.46061.1C	R.46061.2C	
		R	R.46047	R.46047	R.46047.1S	R.46047.2S	R.46047.1C	R.46047.2C	
04	SPORTSBACK LS (4 LUG)	F	R.46070	R.46070	R.46070.1S	R.46070.2S	R.46070.1C	R.46070.2C	
		R	R.46038	R.46038	R.46038.1S	R.46038.2S	R.46038.1C	R.46038.2C	
05-06	ES, O-Z RALLY (4 LUG)	F	R.46060	R.46060	R.46060.1S	R.46060.2S	R.46060.1C	R.46060.2C	
		R							
05-06	ES, O-Z RALLY (5 LUG)	F	R.46039	R.46039	R.46039.1S	R.46039.2S	R.46039.1C	R.46039.2C	
		R							
05-06	RALLIART (5 LUG)	F	R.46061	R.46061	R.46061.1S	R.46061.2S	R.46061.1C	R.46061.2C	
		R	R.46047	R.46047	R.46047.1S	R.46047.2S	R.46047.1C	R.46047.2C	
<b>LANCER EVOLUTION AWD</b>									
2/98-06	V, VI, VII, VIII, MR W/ BREMBO CALIPER	F	R.46064	R.46064	R.46064.1S	R.46064.2S	R.46064.1C	R.46064.2C	
		R	R.46065	R.46065	R.46065.1S	R.46065.2S	R.46065.1C	R.46065.2C	
<b>MIRAGE</b>									
6/92-5/93	2 DR	F	R.46044	R.46044	R.46044.1S	R.46044.2S	R.46044.1C	R.46044.2C	
		R							
6/92-5/93	4 DR (W/ REAR DRUM)	F	R.46043	R.46043	R.46043.1S	R.46043.2S	R.46043.1C	R.46043.2C	
		R							
6/92-5/93	4 DR (W/ REAR DISC)	F	R.46043	R.46043	R.46043.1S	R.46043.2S	R.46043.1C	R.46043.2C	
		R	R.46045	R.46045	R.46045.1S	R.46045.2S	R.46045.1C	R.46045.2C	
6/93-4/96	2 DR (1.5L)	F	R.46044	R.46044	R.46044.1S	R.46044.2S	R.46044.1C	R.46044.2C	
		R							
6/93-4/96	2 DR (1.8L)	F	R.46043	R.46043	R.46043.1S	R.46043.2S	R.46043.1C	R.46043.2C	
		R	R.46045	R.46045	R.46045.1S	R.46045.2S	R.46045.1C	R.46045.2C	
6/93-4/96	4 DR (W/ REAR DRUM)	F	R.46043	R.46043	R.46043.1S	R.46043.2S	R.46043.1C	R.46043.2C	
		R							
6/93-4/96	4 DR (W/ REAR DISC)	F	R.46043	R.46043	R.46043.1S	R.46043.2S	R.46043.1C	R.46043.2C	
		R	R.46045	R.46045	R.46045.1S	R.46045.2S	R.46045.1C	R.46045.2C	
5/96-5/98		F	R.46043	R.46043	R.46043.1S	R.46043.2S	R.46043.1C	R.46043.2C	
		R	R.46045	R.46045	R.46045.1S	R.46045.2S	R.46045.1C	R.46045.2C	
6/98-00	13" WHEEL	F	R.46043	R.46043	R.46043.1S	R.46043.2S	R.46043.1C	R.46043.2C	
		R							
6/98-00	14" WHEEL	F	R.46060	R.46060	R.46060.1S	R.46060.2S	R.46060.1C	R.46060.2C	
		R							
01-02		F	R.46060	R.46060	R.46060.1S	R.46060.2S	R.46060.1C	R.46060.2C	
		R							
<b>MONTERO V6 (EXC SPORT)</b>									
3/93-5/98	3.0L (SOHC)	F	R.46040	R.46040	R.46040.1S	R.46040.2S	R.46040.1C	R.46040.2C	
		R	R.46041	R.46041	R.46041.1S	R.46041.2S	R.46041.1C	R.46041.2C	
3/93-5/98	3.5L (DOHC)	F	R.46054	R.46054	R.46054.1S	R.46054.2S	R.46054.1C	R.46054.2C	
		R	R.46041	R.46041	R.46041.1S	R.46041.2S	R.46041.1C	R.46041.2C	
6/98-1/00	3.0L (SOHC) W/ 15" WHEEL	F	R.46040	R.46040	R.46040.1S	R.46040.2S	R.46040.1C	R.46040.2C	
		R	R.46041	R.46041	R.46041.1S	R.46041.2S	R.46041.1C	R.46041.2C	
6/98-1/00	3.0L (SOHC) W/ 16" WHEEL	F	R.46051	R.46051	R.46051.1S	R.46051.2S	R.46051.1C	R.46051.2C	
		R	R.46041	R.46041	R.46041.1S	R.46041.2S	R.46041.1C	R.46041.2C	
6/98-1/00	3.5L (DOHC) W/ 16" WHEEL	F	R.46054	R.46054	R.46054.1S	R.46054.2S	R.46054.1C	R.46054.2C	
		R	R.46041	R.46041	R.46041.1S	R.46041.2S	R.46041.1C	R.46041.2C	
2/00-07		F	R.46062	R.46062	R.46062.1S	R.46062.2S	R.46062.1C	R.46062.2C	
		R	R.46063	R.46063	R.46063.1S	R.46063.2S	R.46063.1C	R.46063.2C	
<b>MONTERO SPORT (2WD)</b>									
97-99		F	R.46040	R.46040	R.46040.1S	R.46040.2S	R.46040.1C	R.46040.2C	
		R							
00-04	15" WHEEL	F	R.46040	R.46040	R.46040.1S	R.46040.2S	R.46040.1C	R.46040.2C	
		R							
00-04	16" WHEEL	F	R.46051	R.46051	R.46051.1S	R.46051.2S	R.46051.1C	R.46051.2C	

BRAKE DISC		BASIC OEM		SLOTTED		DRILLED & SLOTTED		NOTES
MAKE/MODEL	AXLE	PART #		PART #		PART #		
YEAR	F/R	LEFT	RIGHT	LEFT	RIGHT	LEFT	RIGHT	
	R							
<b>MONTERO SPORT (4WD)</b>								
97-99	F	R.46040	R.46040	R.46040.1S	R.46040.2S	R.46040.1C	R.46040.2C	
	R	R.46041	R.46041	R.46041.1S	R.46041.2S	R.46041.1C	R.46041.2C	
00-04	F	R.46040	R.46040	R.46040.1S	R.46040.2S	R.46040.1C	R.46040.2C	
	R	R.46041	R.46041	R.46041.1S	R.46041.2S	R.46041.1C	R.46041.2C	
00-04	F	R.46051	R.46051	R.46051.1S	R.46051.2S	R.46051.1C	R.46051.2C	
	R	R.46041	R.46041	R.46041.1S	R.46041.2S	R.46041.1C	R.46041.2C	
<b>OUTLANDER</b>								
03-04	F	R.46061	R.46061	R.46061.1S	R.46061.2S	R.46061.1C	R.46061.2C	
	R							
05-06	F	R.46071	R.46071	R.46071.1S	R.46071.2S	R.46071.1C	R.46071.2C	
	R	R.46047	R.46047	R.46047.1S	R.46047.2S	R.46047.1C	R.46047.2C	
07	F	R.63067	R.63067	R.63067.1S	R.63067.2S	R.63067.1C	R.63067.2C	C
	R							
<b>RAIDER</b>								
06-07	F	R.67065	R.67065	R.67065.1S	R.67065.2S	R.67065.1C	R.67065.2C	
	R							
<b>STARION</b>								
83-87	F	R.46007	R.46007	R.46007.1S	R.46007.2S	R.46007.1C	R.46007.2C	A
	R	R.46006	R.46006	R.46006.1S	R.46006.2S	R.46006.1C	R.46006.2C	A
83-87	F	R.46012	R.46012	R.46012.1S	R.46012.2S	R.46012.1C	R.46012.2C	A
	R	R.46013	R.46013	R.46013.1S	R.46013.2S	R.46013.1C	R.46013.2C	A
88-89	F	R.46012	R.46012	R.46012.1S	R.46012.2S	R.46012.1C	R.46012.2C	A
	R	R.46013	R.46013	R.46013.1S	R.46013.2S	R.46013.1C	R.46013.2C	A
<b>3000 GT, GT-SL</b>								
90-99	F	R.46032	R.46032	R.46032.1S	R.46032.2S	R.46032.1C	R.46032.2C	
	R	R.46033	R.46033	R.46033.1S	R.46033.2S	R.46033.1C	R.46033.2C	
<b>3000 GT-VR4</b>								
4/90-5/93	F	R.46031	R.46031	R.46031.1S	R.46031.2S	R.46031.1C	R.46031.2C	
	R	R.46034	R.46034	R.46034.1S	R.46034.2S	R.46034.1C	R.46034.2C	
6/93-99	F	R.46052	R.46052	R.46052.1S	R.46052.2S	R.46052.1C	R.46052.2C	
	R	R.46053	R.46053	R.46053.1S	R.46053.2S	R.46053.1C	R.46053.2C	
<b>NISSAN</b>								
<b>ALTIMA</b>								
93-01	F	R.42055	R.42055	R.42055.1S	R.42055.2S	R.42055.1C	R.42055.2C	
	R							
93-01	F	R.42055	R.42055	R.42055.1S	R.42055.2S	R.42055.1C	R.42055.2C	
	R	R.42051	R.42051	R.42051.1S	R.42051.2S	R.42051.1C	R.42051.2C	
02-04	F	R.42070	R.42070	R.42070.1S	R.42070.2S	R.42070.1C	R.42070.2C	
	R	R.42073	R.42073	R.42073.1S	R.42073.2S	R.42073.1C	R.42073.2C	
05-06	F	R.42070	R.42070	R.42070.1S	R.42070.2S	R.42070.1C	R.42070.2C	
	R	R.42073	R.42073	R.42073.1S	R.42073.2S	R.42073.1C	R.42073.2C	
05-06	F	R.42080	R.42080	R.42080.1S	R.42080.2S	R.42080.1C	R.42080.2C	
	R	R.42073	R.42073	R.42073.1S	R.42073.2S	R.42073.1C	R.42073.2C	
07	F	R.42096	R.42096	R.42096.1S	R.42096.2S	R.42096.1C	R.42096.2C	C
	R							
<b>ARMADA</b>								
04-3/05	F	R.42084	R.42084	R.42084.1S	R.42084.2S	R.42084.1C	R.42084.2C	
	R	R.42081	R.42081	R.42081.1S	R.42081.2S	R.42081.1C	R.42081.2C	
4/05-10/06	F	R.42090	R.42090	R.42090.1S	R.42090.2S	R.42090.1C	R.42090.2C	
	R	R.42081	R.42081	R.42081.1S	R.42081.2S	R.42081.1C	R.42081.2C	
11/05-07	F	R.42094	R.42094	R.42094.1S	R.42094.2S	R.42094.1C	R.42094.2C	
	R	R.42081	R.42081	R.42081.1S	R.42081.2S	R.42081.1C	R.42081.2C	
<b>FRONTIER 2WD</b>								
98-4/99	F	R.42067	R.42067	R.42067.1S	R.42067.2S	R.42067.1C	R.42067.2C	
	R							
5/99-02	F	R.42067	R.42067	R.42067.1S	R.42067.2S	R.42067.1C	R.42067.2C	
	R							
5/99-02	F	R.42029	R.42029	R.42029.1S	R.42029.2S	R.42029.1C	R.42029.2C	
	R							
03-04	F	R.42067	R.42067	R.42067.1S	R.42067.2S	R.42067.1C	R.42067.2C	
	R							
03-04	F	R.42063	R.42063	R.42063.1S	R.42063.2S	R.42063.1C	R.42063.2C	
	R							
05-07	F	R.42089	R.42089	R.42089.1S	R.42089.2S	R.42089.1C	R.42089.2C	
	R	R.42087	R.42087	R.42087.1S	R.42087.2S	R.42087.1C	R.42087.2C	

BRAKE DISC		BASIC OEM		SLOTTED		DRILLED & SLOTTED		NOTES
		AXLE	PART #		PART #		PART #	
MAKE/MODEL	YEAR	F/R	LEFT	RIGHT	LEFT	RIGHT	LEFT	RIGHT
05-07 V6 (4.0L)	F	R.42085	R.42085	R.42085.1S	R.42085.2S	R.42085.1C	R.42085.2C	
	R	R.42087	R.42087	R.42087.1S	R.42087.2S	R.42087.1C	R.42087.2C	
<b>FRONTIER 4WD</b>								
9/97-02	F	R.42029	R.42029	R.42029.1S	R.42029.2S	R.42029.1C	R.42029.2C	
	R							
03-04	F	R.42063	R.42063	R.42063.1S	R.42063.2S	R.42063.1C	R.42063.2C	
	R							
05-07	F	R.42085	R.42085	R.42085.1S	R.42085.2S	R.42085.1C	R.42085.2C	
	R	R.42087	R.42087	R.42087.1S	R.42087.2S	R.42087.1C	R.42087.2C	
<b>MAXIMA</b>								
9/89-1/94 W/ REAR DRUM	F	R.42043	R.42043	R.42043.1S	R.42043.2S	R.42043.1C	R.42043.2C	
	R							
9/89-1/94 W/ REAR DISC	F	R.42043	R.42043	R.42043.1S	R.42043.2S	R.42043.1C	R.42043.2C	
	R	R.42044	R.42044	R.42044.1S	R.42044.2S	R.42044.1C	R.42044.2C	
2/94-3/99	F	R.42043	R.42043	R.42043.1S	R.42043.2S	R.42043.1C	R.42043.2C	
	R	R.42059	R.42059	R.42059.1S	R.42059.2S	R.42059.1C	R.42059.2C	
4/99-01	F	R.42069	R.42069	R.42069.1S	R.42069.2S	R.42069.1C	R.42069.2C	
	R	R.42059	R.42059	R.42059.1S	R.42059.2S	R.42059.1C	R.42059.2C	
02-03	F	R.42070	R.42070	R.42070.1S	R.42070.2S	R.42070.1C	R.42070.2C	
	R	R.42059	R.42059	R.42059.1S	R.42059.2S	R.42059.1C	R.42059.2C	
04-05	F	R.42075	R.42075	R.42075.1S	R.42075.2S	R.42075.1C	R.42075.2C	
	R	R.42073	R.42073	R.42073.1S	R.42073.2S	R.42073.1C	R.42073.2C	
06-07	F	R.42080	R.42080	R.42080.1S	R.42080.2S	R.42080.1C	R.42080.2C	
	R	R.42073	R.42073	R.42073.1S	R.42073.2S	R.42073.1C	R.42073.2C	
<b>MURANO</b>								
03-4/04	F	R.42075	R.42075	R.42075.1S	R.42075.2S	R.42075.1C	R.42075.2C	
	R	R.42078	R.42078	R.42078.1S	R.42078.2S	R.42078.1C	R.42078.2C	
5/04-07	F	R.42080	R.42080	R.42080.1S	R.42080.2S	R.42080.1C	R.42080.2C	
	R	R.42078	R.42078	R.42078.1S	R.42078.2S	R.42078.1C	R.42078.2C	
<b>NX COUPE</b>								
91-93 1.6L (W/ REAR DRUM)	F	R.42035	R.42035	R.42035.1S	R.42035.2S	R.42035.1C	R.42035.2C	
	R							
91-93 1.6L (W/ REAR DISC)	F	R.42035	R.42035	R.42035.1S	R.42035.2S	R.42035.1C	R.42035.2C	
	R	R.42054	R.42054	R.42054.1S	R.42054.2S	R.42054.1C	R.42054.2C	
91-93 2.0L W/O ABS (EXC SE, SER)	F	R.42052	R.42052	R.42052.1S	R.42052.2S	R.42052.1C	R.42052.2C	
	R	R.42054	R.42054	R.42054.1S	R.42054.2S	R.42054.1C	R.42054.2C	
91-93 2.0L W/ ABS (SE, SER W/O ABS)	F	R.42056	R.42056	R.42056.1S	R.42056.2S	R.42056.1C	R.42056.2C	
	R	R.42053	R.42053	R.42053.1S	R.42053.2S	R.42053.1C	R.42053.2C	
<b>PATHFINDER</b>								
86-95 W/ REAR DRUM	F	R.42029	R.42029	R.42029.1S	R.42029.2S	R.42029.1C	R.42029.2C	
	R							
86-95 W/ REAR DISC	F	R.42029	R.42029	R.42029.1S	R.42029.2S	R.42029.1C	R.42029.2C	
	R	R.42039	R.42039	R.42039.1S	R.42039.2S	R.42039.1C	R.42039.2C	
96-98	F	R.42063	R.42063	R.42063.1S	R.42063.2S	R.42063.1C	R.42063.2C	
	R							
99-04	F	R.42068	R.42068	R.42068.1S	R.42068.2S	R.42068.1C	R.42068.2C	
	R							
05-07	F	R.42085	R.42085	R.42085.1S	R.42085.2S	R.42085.1C	R.42085.2C	
	R	R.42086	R.42086	R.42086.1S	R.42086.2S	R.42086.1C	R.42086.2C	
<b>QUEST</b>								
04-07	F	R.42071	R.42071	R.42071.1S	R.42071.2S	R.42071.1C	R.42071.2C	
	R	R.42078	R.42078	R.42078.1S	R.42078.2S	R.42078.1C	R.42078.2C	
<b>SENTRA</b>								
91-94 1.6L (W/ REAR DRUM)	F	R.42035	R.42035	R.42035.1S	R.42035.2S	R.42035.1C	R.42035.2C	
	R							
91-94 1.6L (W/ REAR DISC)	F	R.42035	R.42035	R.42035.1S	R.42035.2S	R.42035.1C	R.42035.2C	
	R	R.42054	R.42054	R.42054.1S	R.42054.2S	R.42054.1C	R.42054.2C	
91-94 2.0L (W/O ABS)	F	R.42052	R.42052	R.42052.1S	R.42052.2S	R.42052.1C	R.42052.2C	
	R	R.42054	R.42054	R.42054.1S	R.42054.2S	R.42054.1C	R.42054.2C	
91-94 2.0L (MADE IN JAPAN) W/ ABS	F	R.42056	R.42056	R.42056.1S	R.42056.2S	R.42056.1C	R.42056.2C	
	R	R.42053	R.42053	R.42053.1S	R.42053.2S	R.42053.1C	R.42053.2C	
91-94 2.0L (MADE IN USA) W/ ABS	F	R.42052	R.42052	R.42052.1S	R.42052.2S	R.42052.1C	R.42052.2C	
	R	R.42054	R.42054	R.42054.1S	R.42054.2S	R.42054.1C	R.42054.2C	
95-97 W/ REAR DRUM	F	R.42060	R.42060	R.42060.1S	R.42060.2S	R.42060.1C	R.42060.2C	
	R							
95-97 W/ REAR DISC	F	R.42060	R.42060	R.42060.1S	R.42060.2S	R.42060.1C	R.42060.2C	
	R	R.42054	R.42054	R.42054.1S	R.42054.2S	R.42054.1C	R.42054.2C	
98-99 1.6L (E, XE) W/ REAR DRUM	F	R.42060	R.42060	R.42060.1S	R.42060.2S	R.42060.1C	R.42060.2C	

BRAKE DISC		BASIC OEM		SLOTTED		DRILLED & SLOTTED		NOTES
MAKE/MODEL	AXLE	PART #		PART #		PART #		
YEAR	F/R	LEFT	RIGHT	LEFT	RIGHT	LEFT	RIGHT	
98-99	1.6L (GLE, GXE) W/ REAR DRUM	R						
		F	R.42061	R.42061	R.42061.1S	R.42061.2S	R.42061.1C	R.42061.2C
		R						
98-99	1.6L (GLE, GXE) W/ REAR DISC	F	R.42061	R.42061	R.42061.1S	R.42061.2S	R.42061.1C	R.42061.2C
		R	R.42054	R.42054	R.42054.1S	R.42054.2S	R.42054.1C	R.42054.2C
98-99	2.0L (SE)	F	R.42061	R.42061	R.42061.1S	R.42061.2S	R.42061.1C	R.42061.2C
		R	R.42054	R.42054	R.42054.1S	R.42054.2S	R.42054.1C	R.42054.2C
00-8/01	1.8L (XE, GXE) W/ REAR DRUM	F	R.42041	R.42041	R.42041.1S	R.42041.2S	R.42041.1C	R.42041.2C
		R						
00-8/01	2.0L (SE) W/ REAR DISC	F	R.42055	R.42055	R.42055.1S	R.42055.2S	R.42055.1C	R.42055.2C
		R	R.42051	R.42051	R.42051.1S	R.42051.2S	R.42051.1C	R.42051.2C
02-4/03	1.8L (XE, GXE) W/ REAR DRUM	F	R.42041	R.42041	R.42041.1S	R.42041.2S	R.42041.1C	R.42041.2C
		R						
02-4/03	2.5L (SE-R)	F	R.42055	R.42055	R.42055.1S	R.42055.2S	R.42055.1C	R.42055.2C
		R	R.42051	R.42051	R.42051.1S	R.42051.2S	R.42051.1C	R.42051.2C
5/03-06	1.8L (BASIC, S)	F	R.42041	R.42041	R.42041.1S	R.42041.2S	R.42041.1C	R.42041.2C
		R						
5/03-06	2.5L (S, SE-R)	F	R.42055	R.42055	R.42055.1S	R.42055.2S	R.42055.1C	R.42055.2C
		R	R.42051	R.42051	R.42051.1S	R.42051.2S	R.42051.1C	R.42051.2C
5/03-06	2.5L SE-R (SPEC V) W/ FRONT BREMBO CALIPER	F	R.42083	R.42083	R.42083.1S	R.42083.2S	R.42083.1C	R.42083.2C
		R	R.42082	R.42082	R.42082.1S	R.42082.2S	R.42082.1C	R.42082.2C
07		F	R.42091	R.42091	R.42091.1S	R.42091.2S	R.42091.1C	R.42091.2C
		R						
<b>SKYLINE (JAPAN)</b>								
8/89-1/95	GT-R (BNR32)	F	R.00205	R.00206	R.00205.1S	R.00205.2S	R.00205.1C	R.00205.2C
		R						
2/93-1/95	GT-R (BNR32); V-SPEC W/ BREMBO CALIPER	F	R.00200	R.00200	R.00200.1S	R.00200.2S	R.00200.1C	R.00200.2C
		R	R.00201	R.00201	R.00201.1S	R.00201.2S	R.00201.1C	R.00201.2C
1/95-1/99	GT-R (BCNR33) W/ BREMBO CALIPER	F	R.00200	R.00200	R.00200.1S	R.00200.2S	R.00200.1C	R.00200.2C
		R	R.00201	R.00201	R.00201.1S	R.00201.2S	R.00201.1C	R.00201.2C
99-9/00	GT-R (BNR34) W/ BREMBO CALIPER	F	R.00200	R.00200	R.00200.1S	R.00200.2S	R.00200.1C	R.00200.2C
		R	R.00201	R.00201	R.00201.1S	R.00201.2S	R.00201.1C	R.00201.2C
10/00-02	GT-R (BNR34) W/ BREMBO CALIPER	F	R.00200	R.00200	R.00200.1S	R.00200.2S	R.00200.1C	R.00200.2C
		R	R.00204	R.00204	R.00204.1S	R.00204.2S	R.00204.1C	R.00204.2C
99-02	GT-R (BNR34) N1 W/ BREMBO CALIPER	F	R.00200	R.00200	R.00200.1S	R.00200.2S	R.00200.1C	R.00200.2C
		R	R.00204	R.00204	R.00204.1S	R.00204.2S	R.00204.1C	R.00204.2C
<b>TITAN</b>								
04-3/05		F	R.42084	R.42084	R.42084.1S	R.42084.2S	R.42084.1C	R.42084.2C
		R	R.42081	R.42081	R.42081.1S	R.42081.2S	R.42081.1C	R.42081.2C
4/05-07		F	R.42090	R.42090	R.42090.1S	R.42090.2S	R.42090.1C	R.42090.2C
		R	R.42081	R.42081	R.42081.1S	R.42081.2S	R.42081.1C	R.42081.2C
<b>VERSA</b>								
07		F	R.42091	R.42091	R.42091.1S	R.42091.2S	R.42091.1C	R.42091.2C
		R						
<b>XTERRA</b>								
00-04		F	R.42063	R.42063	R.42063.1S	R.42063.2S	R.42063.1C	R.42063.2C
		R						
05-07		F	R.42085	R.42085	R.42085.1S	R.42085.2S	R.42085.1C	R.42085.2C
		R	R.42087	R.42087	R.42087.1S	R.42087.2S	R.42087.1C	R.42087.2C
<b>200SX</b>								
95-97	1.6L (W/ REAR DRUM)	F	R.42060	R.42060	R.42060.1S	R.42060.2S	R.42060.1C	R.42060.2C
		R						
95-97	1.6L (W/ REAR DISC)	F	R.42060	R.42060	R.42060.1S	R.42060.2S	R.42060.1C	R.42060.2C
		R	R.42054	R.42054	R.42054.1S	R.42054.2S	R.42054.1C	R.42054.2C
95-97	2.0L (SE-R)	F	R.42061	R.42061	R.42061.1S	R.42061.2S	R.42061.1C	R.42061.2C
		R	R.42054	R.42054	R.42054.1S	R.42054.2S	R.42054.1C	R.42054.2C
98-99	1.6L (W/ REAR DRUM)	F	R.42060	R.42060	R.42060.1S	R.42060.2S	R.42060.1C	R.42060.2C
		R						
98-99	1.6L (W/ REAR DISC)	F	R.42061	R.42061	R.42061.1S	R.42061.2S	R.42061.1C	R.42061.2C
		R	R.42054	R.42054	R.42054.1S	R.42054.2S	R.42054.1C	R.42054.2C
98-99	2.0L (SE-R)	F	R.42061	R.42061	R.42061.1S	R.42061.2S	R.42061.1C	R.42061.2C
		R	R.42054	R.42054	R.42054.1S	R.42054.2S	R.42054.1C	R.42054.2C
<b>240SX</b>								
89-1/94	W/O ABS	F	R.42040	R.42040	R.42040.1S	R.42040.2S	R.42040.1C	R.42040.2C
		R	R.42042	R.42042	R.42042.1S	R.42042.2S	R.42042.1C	R.42042.2C
89-1/94	W/ ABS	F	R.42041	R.42041	R.42041.1S	R.42041.2S	R.42041.1C	R.42041.2C
		R	R.42042	R.42042	R.42042.1S	R.42042.2S	R.42042.1C	R.42042.2C
2/94-6/96	4 LUG (W/O ABS)	F	R.42040	R.42040	R.42040.1S	R.42040.2S	R.42040.1C	R.42040.2C

MAKE/MODEL YEAR		AXLE F/R	BASIC OEM		SLOTTED		DRILLED & SLOTTED		NOTES
			PART #		PART #		PART #		
			LEFT	RIGHT	LEFT	RIGHT	LEFT	RIGHT	
2/94-6/96	5 LUG (W/O ABS)	R	R.42042	R.42042	R.42042.1S	R.42042.2S	R.42042.1C	R.42042.2C	
		F	R.42057	R.42057	R.42057.1S	R.42057.2S	R.42057.1C	R.42057.2C	
		R	R.42062	R.42062	R.42062.1S	R.42062.2S	R.42062.1C	R.42062.2C	
2/94-6/96	W/ ABS	F	R.42057	R.42057	R.42057.1S	R.42057.2S	R.42057.1C	R.42057.2C	
		R	R.42062	R.42062	R.42062.1S	R.42062.2S	R.42062.1C	R.42062.2C	
7/96-98	4 LUG (W/O ABS)	F	R.42041	R.42041	R.42041.1S	R.42041.2S	R.42041.1C	R.42041.2C	
		R	R.42042	R.42042	R.42042.1S	R.42042.2S	R.42042.1C	R.42042.2C	
7/96-98	5 LUG (W/O ABS)	F	R.42064	R.42064	R.42064.1S	R.42064.2S	R.42064.1C	R.42064.2C	
		R	R.42062	R.42062	R.42062.1S	R.42062.2S	R.42062.1C	R.42062.2C	
7/96-98	W/ ABS	F	R.42064	R.42064	R.42064.1S	R.42064.2S	R.42064.1C	R.42064.2C	
		R	R.42062	R.42062	R.42062.1S	R.42062.2S	R.42062.1C	R.42062.2C	
<b>240Z, 260Z, 280Z</b>									
70-7/73		F	R.42011	R.42011	R.42011.1S	R.42011.2S	R.42011.1C	R.42011.2C	A
		R							
8/73-78		F	R.42004	R.42004	R.42004.1S	R.42004.2S	R.42004.1C	R.42004.2C	A
		R							
<b>280Z (TURBO)</b>									
79-81		F	R.42005	R.42005	R.42005.1S	R.42005.2S	R.42005.1C	R.42005.2C	A
		R	R.42014	R.42014	R.42014.1S	R.42014.2S	R.42014.1C	R.42014.2C	A
82-83		F	R.42005	R.42005	R.42005.1S	R.42005.2S	R.42005.1C	R.42005.2C	A
		R	R.42016	R.42016	R.42016.1S	R.42016.2S	R.42016.1C	R.42016.2C	A
<b>300ZX (EXC TURBO)</b>									
84-85		F	R.42034	R.42034	R.42034.1S	R.42034.2S	R.42034.1C	R.42034.2C	
		R	R.42021	R.42021	R.42021.1S	R.42021.2S	R.42021.1C	R.42021.2C	
86		F	R.42023	R.42023	R.42023.1S	R.42023.2S	R.42023.1C	R.42023.2C	
		R	R.42026	R.42026	R.42026.1S	R.42026.2S	R.42026.1C	R.42026.2C	
87-1/89		F	R.42023	R.42023	R.42023.1S	R.42023.2S	R.42023.1C	R.42023.2C	
		R	R.42037	R.42037	R.42037.1S	R.42037.2S	R.42037.1C	R.42037.2C	
2/89-6/90		F	R.42046	R.42046	R.42046.1S	R.42046.2S	R.42046.1C	R.42046.2C	
		R	R.42047	R.42047	R.42047.1S	R.42047.2S	R.42047.1C	R.42047.2C	
7/90-96		F	R.42050	R.42050	R.42050.1S	R.42050.2S	R.42050.1C	R.42050.2C	
		R	R.42047	R.42047	R.42047.1S	R.42047.2S	R.42047.1C	R.42047.2C	
<b>300ZX (TURBO)</b>									
84-86		F	R.42023	R.42023	R.42023.1S	R.42023.2S	R.42023.1C	R.42023.2C	
		R	R.42026	R.42026	R.42026.1S	R.42026.2S	R.42026.1C	R.42026.2C	
87-1/89		F	R.42036	R.42036	R.42036.1S	R.42036.2S	R.42036.1C	R.42036.2C	
		R	R.42037	R.42037	R.42037.1S	R.42037.2S	R.42037.1C	R.42037.2C	
6/89-96		F	R.42050	R.42050	R.42050.1S	R.42050.2S	R.42050.1C	R.42050.2C	
		R	R.42047	R.42047	R.42047.1S	R.42047.2S	R.42047.1C	R.42047.2C	
<b>350Z</b>									
6/02-05	BASE MODEL	F	R.42074	R.42074	R.42074.1S	R.42074.2S	R.42074.1C	R.42074.2C	
		R	R.42077	R.42077	R.42077.1S	R.42077.2S	R.42077.1C	R.42077.2C	
6/02-05	W/ BREMBO CALIPER	F	R.42076	R.42076	R.42076.1S	R.42076.2S	R.42076.1C	R.42076.2C	
		R	R.42079	R.42079	R.42079.1S	R.42079.2S	R.42079.1C	R.42079.2C	
06-07	BASE MODEL	F	R.42080	R.42080	R.42080.1S	R.42080.2S	R.42080.1C	R.42080.2C	
		R	R.42088	R.42088	R.42088.1S	R.42088.2S	R.42088.1C	R.42088.2C	
06-07	W/ BREMBO CALIPER	F	R.42076	R.42076	R.42076.1S	R.42076.2S	R.42076.1C	R.42076.2C	
		R	R.42079	R.42079	R.42079.1S	R.42079.2S	R.42079.1C	R.42079.2C	
<b>OLDSMOBILE</b>									
<b>ACHIEVA</b>									
92-98		F	R.62034	R.62034	R.62034.1S	R.62034.2S	R.62034.1C	R.62034.2C	
		R							
<b>ALERO</b>									
99-02		F	R.62056	R.62056	R.62056.1S	R.62056.2S	R.62056.1C	R.62056.2C	
		R	R.62058	R.62058	R.62058.1S	R.62058.2S	R.62058.1C	R.62058.2C	
03-04	W/ REAR DRUM	F	R.62056	R.62056	R.62056.1S	R.62056.2S	R.62056.1C	R.62056.2C	
		R							
03-04	W/ REAR DISC	F	R.62056	R.62056	R.62056.1S	R.62056.2S	R.62056.1C	R.62056.2C	
		R	R.62058	R.62058	R.62058.1S	R.62058.2S	R.62058.1C	R.62058.2C	
<b>AURORA</b>									
95-96		F	R.62050	R.62050	R.62050.1S	R.62050.2S	R.62050.1C	R.62050.2C	
		R	R.62045	R.62045	R.62045.1S	R.62045.2S	R.62045.1C	R.62045.2C	
97-03		F	R.62055	R.62055	R.62055.1S	R.62055.2S	R.62055.1C	R.62055.2C	
		R	R.62045	R.62045	R.62045.1S	R.62045.2S	R.62045.1C	R.62045.2C	
<b>BRAVADA</b>									
91-96		F	R.66006	R.66006	R.66006.1S	R.66006.2S	R.66006.1C	R.66006.2C	
		R							



MAKE/MODEL YEAR		AXLE F/R	BASIC OEM		SLOTTED		DRILLED & SLOTTED		NOTES
			PART #		PART #		PART #		
			LEFT	RIGHT	LEFT	RIGHT	LEFT	RIGHT	
97-01		F	R.66038	R.66038	R.66038.1S	R.66038.2S	R.66038.1C	R.66038.2C	
		R	R.66036	R.66036	R.66036.1S	R.66036.2S	R.66036.1C	R.66036.2C	
02-04		F	R.66051	R.66051	R.66051.1S	R.66051.2S	R.66051.1C	R.66051.2C	
		R	R.66052	R.66052	R.66052.1S	R.66052.2S	R.66052.1C	R.66052.2C	A
<b>CALAIS</b>									
90	EXC PERFORMANCE PKG	F	R.62023	R.62023	R.62023.1S	R.62023.2S	R.62023.1C	R.62023.2C	
		R							
90-91	W/ PERFORMANCE PKG	F	R.62034	R.62034	R.62034.1S	R.62034.2S	R.62034.1C	R.62034.2C	
		R							
<b>CIERA, CUTLASS CIERA, CRUISER WAGON</b>									
90-96		F	R.62017	R.62017	R.62017.1S	R.62017.2S	R.62017.1C	R.62017.2C	
		R							
<b>CUTLASS (N BODY)</b>									
97-99		F	R.62056	R.62056	R.62056.1S	R.62056.2S	R.62056.1C	R.62056.2C	
		R							
<b>CUTLASS SUPREME (W BODY)</b>									
89-93		F	R.62028	R.62028	R.62028.1S	R.62028.2S	R.62028.1C	R.62028.2C	
		R	R.62029	R.62029	R.62029.1S	R.62029.2S	R.62029.1C	R.62029.2C	
94-95	W/ 267MM DISC	F	R.62028	R.62028	R.62028.1S	R.62028.2S	R.62028.1C	R.62028.2C	
		R	R.62051	R.62051	R.62051.1S	R.62051.2S	R.62051.1C	R.62051.2C	
94-97	W/ 286MM DISC	F	R.62054	R.62054	R.62054.1S	R.62054.2S	R.62054.1C	R.62054.2C	
		R	R.62051	R.62051	R.62051.1S	R.62051.2S	R.62051.1C	R.62051.2C	
<b>INTRIGUE</b>									
98-99	STD BRAKE	F	R.62057	R.62057	R.62057.1S	R.62057.2S	R.62057.1C	R.62057.2C	
		R	R.62058	R.62058	R.62058.1S	R.62058.2S	R.62058.1C	R.62058.2C	
98-99	HD BRAKE	F	R.62055	R.62055	R.62055.1S	R.62055.2S	R.62055.1C	R.62055.2C	
		R	R.62058	R.62058	R.62058.1S	R.62058.2S	R.62058.1C	R.62058.2C	
00-02		F	R.62057	R.62057	R.62057.1S	R.62057.2S	R.62057.1C	R.62057.2C	
		R	R.62058	R.62058	R.62058.1S	R.62058.2S	R.62058.1C	R.62058.2C	
<b>LSS</b>									
97		F	R.62050	R.62050	R.62050.1S	R.62050.2S	R.62050.1C	R.62050.2C	
		R							
98-99		F	R.62057	R.62057	R.62057.1S	R.62057.2S	R.62057.1C	R.62057.2C	
		R							
<b>REGENCY</b>									
97-99		F	R.62055	R.62055	R.62055.1S	R.62055.2S	R.62055.1C	R.62055.2C	
		R	R.62045	R.62045	R.62045.1S	R.62045.2S	R.62045.1C	R.62045.2C	
<b>SILHOUETTE APV</b>									
90-91		F	R.62017	R.62017	R.62017.1S	R.62017.2S	R.62017.1C	R.62017.2C	
		R							
92-96		F	R.62050	R.62050	R.62050.1S	R.62050.2S	R.62050.1C	R.62050.2C	
		R							
97-01		F	R.62057	R.62057	R.62057.1S	R.62057.2S	R.62057.1C	R.62057.2C	
		R							
02-04	2WD (W/ REAR DRUM)	F	R.62057	R.62057	R.62057.1S	R.62057.2S	R.62057.1C	R.62057.2C	
		R							
02-04	AWD (W/ REAR DISC)	F	R.66047	R.66047	R.66047.1S	R.66047.2S	R.66047.1C	R.66047.2C	
		R	R.66048	R.66048	R.66048.1S	R.66048.2S	R.66048.1C	R.66048.2C	
<b>PLYMOUTH</b>									
<b>BREEZE</b>									
96-00	W/ REAR DRUM	F	R.63041	R.63041	R.63041.1S	R.63041.2S	R.63041.1C	R.63041.2C	
		R							
96-00	W/ REAR DISC (14" WHEEL)	F	R.63041	R.63041	R.63041.1S	R.63041.2S	R.63041.1C	R.63041.2C	
		R	R.63043	R.63043	R.63043.1S	R.63043.2S	R.63043.1C	R.63043.2C	
96-00	W/ REAR DISC (15" WHEEL)	F	R.63042	R.63042	R.63042.1S	R.63042.2S	R.63042.1C	R.63042.2C	
		R	R.63043	R.63043	R.63043.1S	R.63043.2S	R.63043.1C	R.63043.2C	
<b>LASER</b>									
4/89-92		F	R.46042	R.46042	R.46042.1S	R.46042.2S	R.46042.1C	R.46042.2C	
		R	R.46028	R.46028	R.46028.1S	R.46028.2S	R.46028.1C	R.46028.2C	
93-94	EXC 4WD TURBO	F	R.46042	R.46042	R.46042.1S	R.46042.2S	R.46042.1C	R.46042.2C	
		R	R.46028	R.46028	R.46028.1S	R.46028.2S	R.46028.1C	R.46028.2C	
93-94	4WD TURBO	F	R.46032	R.46032	R.46032.1S	R.46032.2S	R.46032.1C	R.46032.2C	
		R	R.46028	R.46028	R.46028.1S	R.46028.2S	R.46028.1C	R.46028.2C	
<b>NEON</b>									
94-95	W/ REAR DRUM (4 LUG)	F	R.63038	R.63038	R.63038.1S	R.63038.2S	R.63038.1C	R.63038.2C	
		R							
94-95	W/ REAR DRUM (5 LUG)	F	R.63039	R.63039	R.63039.1S	R.63039.2S	R.63039.1C	R.63039.2C	

BRAKE DISC		BASIC OEM		SLOTTED		DRILLED & SLOTTED		
MAKE/MODEL	AXLE	PART #		PART #		PART #		NOTES
YEAR	F/R	LEFT	RIGHT	LEFT	RIGHT	LEFT	RIGHT	
	R							
94-95	W/ REAR DISC	F R.63039	R.63039	R.63039.1S	R.63039.2S	R.63039.1C	R.63039.2C	
	R	R.63040	R.63040	R.63040.1S	R.63040.2S	R.63040.1C	R.63040.2C	
96-99	W/ REAR DRUM	F R.63039	R.63039	R.63039.1S	R.63039.2S	R.63039.1C	R.63039.2C	
	R							
96-99	W/ REAR DISC	F R.63039	R.63039	R.63039.1S	R.63039.2S	R.63039.1C	R.63039.2C	
	R	R.63040	R.63040	R.63040.1S	R.63040.2S	R.63040.1C	R.63040.2C	
00-01	W/ REAR DRUM	F R.63050	R.63050	R.63050.1S	R.63050.2S	R.63050.1C	R.63050.2C	
	R							
00-01	W/ REAR DISC	F R.63050	R.63050	R.63050.1S	R.63050.2S	R.63050.1C	R.63050.2C	
	R	R.63040	R.63040	R.63040.1S	R.63040.2S	R.63040.1C	R.63040.2C	
<b>PROWLER</b>								
97-01	F	R.67039	R.67039	R.67039.1S	R.67039.2S	R.67039.1C	R.67039.2C	
	R							
<b>PONTIAC</b>								
<b>AZTEC</b>								
01-05	2WD	F R.66046	R.66046	R.66046.1S	R.66046.2S	R.66046.1C	R.66046.2C	
	R							
01-05	4WD	F R.66047	R.66047	R.66047.1S	R.66047.2S	R.66047.1C	R.66047.2C	
	R	R.66048	R.66048	R.66048.1S	R.66048.2S	R.66048.1C	R.66048.2C	
<b>BONNEVILLE</b>								
90-91	F	R.62017	R.62017	R.62017.1S	R.62017.2S	R.62017.1C	R.62017.2C	
	R							
92-97	F	R.62050	R.62050	R.62050.1S	R.62050.2S	R.62050.1C	R.62050.2C	
	R							
98-99	F	R.62057	R.62057	R.62057.1S	R.62057.2S	R.62057.1C	R.62057.2C	
	R							
00-03	SE	F R.62057	R.62057	R.62057.1S	R.62057.2S	R.62057.1C	R.62057.2C	
	R	R.62045	R.62045	R.62045.1S	R.62045.2S	R.62045.1C	R.62045.2C	
00-03	SLE, SSEI	F R.62055	R.62055	R.62055.1S	R.62055.2S	R.62055.1C	R.62055.2C	
	R	R.62045	R.62045	R.62045.1S	R.62045.2S	R.62045.1C	R.62045.2C	
04	SE	F R.62057	R.62057	R.62057.1S	R.62057.2S	R.62057.1C	R.62057.2C	
	R	R.62045	R.62045	R.62045.1S	R.62045.2S	R.62045.1C	R.62045.2C	
04	SLE	F R.62055	R.62055	R.62055.1S	R.62055.2S	R.62055.1C	R.62055.2C	
	R	R.62045	R.62045	R.62045.1S	R.62045.2S	R.62045.1C	R.62045.2C	
04	GXP	F R.62084	R.62084	R.62084.1S	R.62084.2S	R.62084.1C	R.62084.2C	
	R	R.62064	R.62064	R.62064.1S	R.62064.2S	R.62064.1C	R.62064.2C	
05	SE	F R.62057	R.62057	R.62057.1S	R.62057.2S	R.62057.1C	R.62057.2C	
	R	R.62045	R.62045	R.62045.1S	R.62045.2S	R.62045.1C	R.62045.2C	
05	SLE	F R.62087	R.62087	R.62087.1S	R.62087.2S	R.62087.1C	R.62087.2C	
	R	R.62045	R.62045	R.62045.1S	R.62045.2S	R.62045.1C	R.62045.2C	
05	GXP	F R.62084	R.62084	R.62084.1S	R.62084.2S	R.62084.1C	R.62084.2C	
	R	R.62064	R.62064	R.62064.1S	R.62064.2S	R.62064.1C	R.62064.2C	
<b>FIREBIRD</b>								
89-92	W/ REAR DRUM	F R.62013	R.62013	R.62013.1S	R.62013.2S	R.62013.1C	R.62013.2C	
	R							
89-92	W/ REAR DISC	F R.62013	R.62013	R.62013.1S	R.62013.2S	R.62013.1C	R.62013.2C	
	R	R.62033	R.62033	R.62033.1S	R.62033.2S	R.62033.1C	R.62033.2C	
89-92	W/ PERFORMANCE PKG, TURBO	F R.80003	R.80003	R.80003.1S	R.80003.2S	R.80003.1C	R.80003.2C	
	R	R.62033	R.62033	R.62033.1S	R.62033.2S	R.62033.1C	R.62033.2C	
93-97	W/ REAR DRUM	F R.62050	R.62050	R.62050.1S	R.62050.2S	R.62050.1C	R.62050.2C	
	R							
93-97	W/ REAR DISC	F R.62050	R.62050	R.62050.1S	R.62050.2S	R.62050.1C	R.62050.2C	
	R	R.62049	R.62049	R.62049.1S	R.62049.2S	R.62049.1C	R.62049.2C	
98-02	F	R.62055	R.62055	R.62055.1S	R.62055.2S	R.62055.1C	R.62055.2C	
	R	R.62065	R.62065	R.62065.1S	R.62065.2S	R.62065.1C	R.62065.2C	
<b>G5, G5 PURSUIT</b>								
05-07	BASE, SE (2.2L)	F R.62072	R.62072	R.62072.1S	R.62072.2S	R.62072.1C	R.62072.2C	
	R							
05-07	GT (2.4L)	F R.62078	R.62078	R.62078.1S	R.62078.2S	R.62078.1C	R.62078.2C	
	R	R.62079	R.62079	R.62079.1S	R.62079.2S	R.62079.1C	R.62079.2C	
<b>G6</b>								
05	F	R.62078	R.62078	R.62078.1S	R.62078.2S	R.62078.1C	R.62078.2C	
	R	R.62079	R.62079	R.62079.1S	R.62079.2S	R.62079.1C	R.62079.2C	
06-07	2.4L (4 CYL)	F R.62077	R.62077	R.62077.1S	R.62077.2S	R.62077.1C	R.62077.2C	
	R	R.62079	R.62079	R.62079.1S	R.62079.2S	R.62079.1C	R.62079.2C	
06-07	3.5L, 3.9L (V6)	F R.62078	R.62078	R.62078.1S	R.62078.2S	R.62078.1C	R.62078.2C	

BRAKE DISC		BASIC OEM		SLOTTED		DRILLED & SLOTTED		NOTES	
		AXLE	PART #		PART #		PART #		
MAKE/MODEL	YEAR	F/R	LEFT	RIGHT	LEFT	RIGHT	LEFT	RIGHT	
		R	R.62079	R.62079	R.62079.1S	R.62079.2S	R.62079.1C	R.62079.2C	
<b>GRAND AM</b>									
90	EXC PERFORMANCE PKG (WS6)	F	R.62023	R.62023	R.62023.1S	R.62023.2S	R.62023.1C	R.62023.2C	
		R							
90	W/ PERFORMANCE PKG WS6	F	R.62034	R.62034	R.62034.1S	R.62034.2S	R.62034.1C	R.62034.2C	
		R							
91-98		F	R.62034	R.62034	R.62034.1S	R.62034.2S	R.62034.1C	R.62034.2C	
		R							
99-05	W/ REAR DRUM	F	R.62056	R.62056	R.62056.1S	R.62056.2S	R.62056.1C	R.62056.2C	
		R							
99-05	W/ REAR DISC	F	R.62056	R.62056	R.62056.1S	R.62056.2S	R.62056.1C	R.62056.2C	
		R	R.62058	R.62058	R.62058.1S	R.62058.2S	R.62058.1C	R.62058.2C	
<b>GRAND PRIX</b>									
89-93		F	R.62028	R.62028	R.62028.1S	R.62028.2S	R.62028.1C	R.62028.2C	
		R	R.62029	R.62029	R.62029.1S	R.62029.2S	R.62029.1C	R.62029.2C	
94-96	W/ 267MM DISC	F	R.62028	R.62028	R.62028.1S	R.62028.2S	R.62028.1C	R.62028.2C	
		R	R.62051	R.62051	R.62051.1S	R.62051.2S	R.62051.1C	R.62051.2C	
95-96	W/ 286MM DISC	F	R.62054	R.62054	R.62054.1S	R.62054.2S	R.62054.1C	R.62054.2C	
		R	R.62051	R.62051	R.62051.1S	R.62051.2S	R.62051.1C	R.62051.2C	
97-03		F	R.62057	R.62057	R.62057.1S	R.62057.2S	R.62057.1C	R.62057.2C	
		R	R.62058	R.62058	R.62058.1S	R.62058.2S	R.62058.1C	R.62058.2C	
04-07	EXC GXP	F	R.62073	R.62073	R.62073.1S	R.62073.2S	R.62073.1C	R.62073.2C	
		R	R.62074	R.62074	R.62074.1S	R.62074.2S	R.62074.1C	R.62074.2C	
05-07	GXP	F	R.62091	R.62091					D
		R	R.62092	R.62092					D
<b>GTO</b>									
04		F	R.62081	R.62081	R.62081.1S	R.62081.2S	R.62081.1C	R.62081.2C	
		R	R.62080	R.62080	R.62080.1S	R.62080.2S	R.62080.1C	R.62080.2C	
05-06		F	R.62089	R.62089	R.62089.1S	R.62089.2S	R.62089.1C	R.62089.2C	
		R	R.62090	R.62090	R.62090.1S	R.62090.2S	R.62090.1C	R.62090.2C	
<b>PURSUIT (SEE G5 PURSUIT)</b>									
<b>SOLSTICE</b>									
06-07		F	R.62093	R.62093	R.62093.1S	R.62093.2S	R.62093.1C	R.62093.2C	
		R	R.62094	R.62094	R.62094.1S	R.62094.2S	R.62094.1C	R.62094.2C	
<b>SUNBIRD, SUNFIRE</b>									
89-91		F	R.62023	R.62023	R.62023.1S	R.62023.2S	R.62023.1C	R.62023.2C	
		R							
92-05		F	R.62034	R.62034	R.62034.1S	R.62034.2S	R.62034.1C	R.62034.2C	
		R							
<b>TORRENT</b>									
06		F	R.62068	R.62068	R.62068.1S	R.62068.2S	R.62068.1C	R.62068.2C	
		R							
<b>VIBE</b>									
03-07	W/ REAR DRUM	F	R.44114	R.44114	R.44114.1S	R.44114.2S	R.44114.1C	R.44114.2C	
		R							
03-07	W/ REAR DISC	F	R.44114	R.44114	R.44114.1S	R.44114.2S	R.44114.1C	R.44114.2C	
		R	R.44115	R.44115	R.44115.1S	R.44115.2S	R.44115.1C	R.44115.2C	
<b>PORSCHE</b>									
<b>BOXSTER (EXC S)</b>									
97-04		F	R.37030	R.37030	R.37030.1S	R.37030.2S	R.37030.1C	R.37030.2C	
		R	R.37031	R.37031	R.37031.1S	R.37031.2S	R.37031.1C	R.37031.2C	
<b>CAYENNE</b>									
03	350MM FRONT DISC	F	R.33090	R.33091	R.33090.1S	R.33090.2S	R.33090.1C	R.33090.2C	B
		R	R.33078	R.33078	R.33078.1S	R.33078.2S	R.33078.1C	R.33078.2C	
04-05	330MM FRONT DISC	F	R.33080	R.33079	R.33080.1S	R.33080.2S	R.33080.1C	R.33080.2C	B
		R	R.33078	R.33078	R.33078.1S	R.33078.2S	R.33078.1C	R.33078.2C	
04-05	350MM FRONT DISC	F	R.33090	R.33091	R.33090.1S	R.33090.2S	R.33090.1C	R.33090.2C	B
		R	R.33078	R.33078	R.33078.1S	R.33078.2S	R.33078.1C	R.33078.2C	
05-06	330MM FRONT DISC	F	R.33080	R.33079	R.33080.1S	R.33080.2S	R.33080.1C	R.33080.2C	B
		R	R.33078	R.33078	R.33078.1S	R.33078.2S	R.33078.1C	R.33078.2C	
05-06	350MM FRONT DISC	F	R.33090	R.33091	R.33090.1S	R.33090.2S	R.33090.1C	R.33090.2C	B
		R	R.33078	R.33078	R.33078.1S	R.33078.2S	R.33078.1C	R.33078.2C	
<b>911 CARRERA 2 (EXC TURBO, TURBO LOOK, 2S)</b>									
90-93		F	R.37025	R.37025	R.37025.1S	R.37025.2S	R.37025.1C	R.37025.2C	
		R	R.37023	R.37023	R.37023.1S	R.37023.2S	R.37023.1C	R.37023.2C	
94	TYPE 964	F	R.37025	R.37025	R.37025.1S	R.37025.2S	R.37025.1C	R.37025.2C	
		R	R.37023	R.37023	R.37023.1S	R.37023.2S	R.37023.1C	R.37023.2C	

BRAKE DISC		BASIC OEM		SLOTTED		DRILLED & SLOTTED		
MAKE/MODEL	AXLE	PART #		PART #		PART #		NOTES
YEAR	F/R	LEFT	RIGHT	LEFT	RIGHT	LEFT	RIGHT	
<b>911 CARRERA 4 (EXC TURBO, TURBO LOOK, 4S)</b>								
90-94	F	R.37025	R.37025	R.37025.1S	R.37025.2S	R.37025.1C	R.37025.2C	
	R	R.37023	R.37023	R.37023.1S	R.37023.2S	R.37023.1C	R.37023.2C	
<b>911 CARRERA 4 (TURBO LOOK, CARRERA 4S)</b>								
91-94	F	R.37025	R.37025	R.37025.1S	R.37025.2S	R.37025.1C	R.37025.2C	
	R							
<b>SAAB</b>								
<b>9-2X AWD</b>								
05-06	LINEAR (2.5L)	F	R.47012	R.47012	R.47012.1S	R.47012.2S	R.47012.1C	R.47012.2C
		R	R.47011	R.47011	R.47011.1S	R.47011.2S	R.47011.1C	R.47011.2C
05-06	AERO (2.0L) TURBO	F	R.47018	R.47018	R.47018.1S	R.47018.2S	R.47018.1C	R.47018.2C
		R	R.47011	R.47011	R.47011.1S	R.47011.2S	R.47011.1C	R.47011.2C
<b>9-3</b>								
98-02	EXC VIGGEN	F	R.38012	R.38012	R.38012.1S	R.38012.2S	R.38012.1C	R.38012.2C
		R	R.38011	R.38011	R.38011.1S	R.38011.2S	R.38011.1C	R.38011.2C
99-02	VIGGEN	F	R.38014	R.38014	R.38014.1S	R.38014.2S	R.38014.1C	R.38014.2C
		R	R.38011	R.38011	R.38011.1S	R.38011.2S	R.38011.1C	R.38011.2C
03	LINEAR	F	R.38016	R.38016	R.38016.1S	R.38016.2S	R.38016.1C	R.38016.2C
	W/ 285MM FRONT DISC	R	R.38018	R.38018	R.38018.1S	R.38018.2S	R.38018.1C	R.38018.2C
03	CONVERTIBLE	F	R.38012	R.38012	R.38012.1S	R.38012.2S	R.38012.1C	R.38012.2C
	W/ 285MM FRONT DISC	R	R.38011	R.38011	R.38011.1S	R.38011.2S	R.38011.1C	R.38011.2C
03	W/ 302MM FRONT DISC	F	R.38017	R.38017	R.38017.1S	R.38017.2S	R.38017.1C	R.38017.2C
		R	R.38019	R.38019	R.38019.1S	R.38019.2S	R.38019.1C	R.38019.2C
04-07	W/ 285MM FRONT DISC	F	R.38016	R.38016	R.38016.1S	R.38016.2S	R.38016.1C	R.38016.2C
		R	R.38018	R.38018	R.38018.1S	R.38018.2S	R.38018.1C	R.38018.2C
04-07	W/ 302MM FRONT DISC	F	R.38017	R.38017	R.38017.1S	R.38017.2S	R.38017.1C	R.38017.2C
		R	R.38019	R.38019	R.38019.1S	R.38019.2S	R.38019.1C	R.38019.2C
06-07	W/ 314MM FRONT DISC	F	R.38020	R.38020	R.38020.1S	R.38020.2S	R.38020.1C	R.38020.2C
		R	R.38019	R.38019	R.38019.1S	R.38019.2S	R.38019.1C	R.38019.2C
<b>9-5</b>								
98-99		F	R.38012	R.38012	R.38012.1S	R.38012.2S	R.38012.1C	R.38012.2C
		R	R.38011	R.38011	R.38011.1S	R.38011.2S	R.38011.1C	R.38011.2C
99-01	EXC AERO	F	R.38012	R.38012	R.38012.1S	R.38012.2S	R.38012.1C	R.38012.2C
		R	R.38013	R.38013	R.38013.1S	R.38013.2S	R.38013.1C	R.38013.2C
99-01	AERO	F	R.38014	R.38014	R.38014.1S	R.38014.2S	R.38014.1C	R.38014.2C
		R	R.38013	R.38013	R.38013.1S	R.38013.2S	R.38013.1C	R.38013.2C
02-04	W/ 288MM FRONT DISC	F	R.38012	R.38012	R.38012.1S	R.38012.2S	R.38012.1C	R.38012.2C
		R	R.38013	R.38013	R.38013.1S	R.38013.2S	R.38013.1C	R.38013.2C
02-04	W/ 308MM FRONT DISC	F	R.38014	R.38014	R.38014.1S	R.38014.2S	R.38014.1C	R.38014.2C
		R	R.38015	R.38015	R.38015.1S	R.38015.2S	R.38015.1C	R.38015.2C
05-06	W/ 288MM FRONT DISC	F	R.38012	R.38012	R.38012.1S	R.38012.2S	R.38012.1C	R.38012.2C
		R	R.38013	R.38013	R.38013.1S	R.38013.2S	R.38013.1C	R.38013.2C
05-07	W/ 308MM FRONT DISC	F	R.38014	R.38014	R.38014.1S	R.38014.2S	R.38014.1C	R.38014.2C
		R	R.38013	R.38013	R.38013.1S	R.38013.2S	R.38013.1C	R.38013.2C
<b>9-7X</b>								
06-07	5.3L (V8)	F	R.66053	R.66053	R.66053.1S	R.66053.2S	R.66053.1C	R.66053.2C
		R	R.66052	R.66052	R.66052.1S	R.66052.2S	R.66052.1C	R.66052.2C
<b>900 SERIES</b>								
8/87-93		F	R.38006	R.38006	R.38006.1S	R.38006.2S	R.38006.1C	R.38006.2C
		R	R.38007	R.38007	R.38007.1S	R.38007.2S	R.38007.1C	R.38007.2C
94-96		F	R.38009	R.38009	R.38009.1S	R.38009.2S	R.38009.1C	R.38009.2C
		R	R.38010	R.38010	R.38010.1S	R.38010.2S	R.38010.1C	R.38010.2C
97-98		F	R.38012	R.38012	R.38012.1S	R.38012.2S	R.38012.1C	R.38012.2C
		R	R.38011	R.38011	R.38011.1S	R.38011.2S	R.38011.1C	R.38011.2C
<b>9000 S</b>								
90-98		F	R.38008	R.38008	R.38008.1S	R.38008.2S	R.38008.1C	R.38008.2C
		R	R.38007	R.38007	R.38007.1S	R.38007.2S	R.38007.1C	R.38007.2C
<b>9000 TURBO</b>								
88-98		F	R.38008	R.38008	R.38008.1S	R.38008.2S	R.38008.1C	R.38008.2C
		R	R.38007	R.38007	R.38007.1S	R.38007.2S	R.38007.1C	R.38007.2C
<b>SATURN</b>								
<b>AURA</b>								
07		F	R.62078	R.62078	R.62078.1S	R.62078.2S	R.62078.1C	R.62078.2C
		R	R.62079	R.62079	R.62079.1S	R.62079.2S	R.62079.1C	R.62079.2C
<b>ION</b>								
03		F	R.62072	R.62072	R.62072.1S	R.62072.2S	R.62072.1C	R.62072.2C

BRAKE DISC		BASIC OEM		SLOTTED		DRILLED & SLOTTED		NOTES	
		MAKE/MODEL	AXLE	PART #		PART #			PART #
YEAR		F/R	LEFT	RIGHT	LEFT	RIGHT	LEFT	RIGHT	
04-07	EXC REDLINE	R F	R.62072	R.62072	R.62072.1S	R.62072.2S	R.62072.1C	R.62072.2C	
04-07	REDLINE	R F	R.62078 R.62079	R.62078 R.62079	R.62078.1S R.62079.1S	R.62078.2S R.62079.2S	R.62078.1C R.62079.1C	R.62078.2C R.62079.2C	
<b>L SERIES-SEDAN LS, WAGON LW</b>									
00-04	W/ REAR DRUM	F R	R.38012	R.38012	R.38012.1S	R.38012.2S	R.38012.1C	R.38012.2C	A
00-04	W/ REAR DISC	F R	R.38012 R.38011	R.38012 R.38011	R.38012.1S R.38011.1S	R.38012.2S R.38011.2S	R.38012.1C R.38011.1C	R.38012.2C R.38011.2C	A A
05		F R	R.38012 R.38011	R.38012 R.38011	R.38012.1S R.38011.1S	R.38012.2S R.38011.2S	R.38012.1C R.38011.1C	R.38012.2C R.38011.2C	A A
<b>RELAY</b>									
05	FWD	F R	R.62073 R.66060	R.62073 R.66060	R.62073.1S R.66060.1S	R.62073.2S R.66060.2S	R.62073.1C R.66060.1C	R.62073.2C R.66060.2C	
05	AWD	F R	R.62073 R.66058	R.62073 R.66058	R.62073.1S R.66058.1S	R.62073.2S R.66058.2S	R.62073.1C R.66058.1C	R.62073.2C R.66058.2C	
06	FWD (EXC SPECIAL SUSPENSION)	F R	R.66061 R.66062	R.66061 R.66062	R.66061.1S R.66062.1S	R.66061.2S R.66062.2S	R.66061.1C R.66062.1C	R.66061.2C R.66062.2C	
06	FWD (W/ SPECIAL SUSPENSION)	F R	R.66061 R.66066	R.66061 R.66066	R.66061.1S R.66066.1S	R.66061.2S R.66066.2S	R.66061.1C R.66066.1C	R.66061.2C R.66066.2C	
07	AWD	F R	R.66061 R.66062	R.66061 R.66062	R.66061.1S R.66062.1S	R.66061.2S R.66062.2S	R.66061.1C R.66062.1C	R.66061.2C R.66062.2C	
<b>S SERIES-COUPE SC, SEDAN SL, WAGON SW</b>									
91-98		F R	R.62038	R.62038	R.62038.1S	R.62038.2S	R.62038.1C	R.62038.2C	
91-98		F R	R.62038 R.62037	R.62038 R.62037	R.62038.1S R.62037.1S	R.62038.2S R.62037.2S	R.62038.1C R.62037.1C	R.62038.2C R.62037.2C	
99-02		F R	R.62038	R.62038	R.62038.1S	R.62038.2S	R.62038.1C	R.62038.2C	
<b>SKY</b>									
07		F R	R.62093 R.62094	R.62093 R.62094	R.62093.1S R.62094.1S	R.62093.2S R.62094.2S	R.62093.1C R.62094.1C	R.62093.2C R.62094.2C	
<b>VUE</b>									
02-07		F R	R.62068	R.62068	R.62068.1S	R.62068.2S	R.62068.1C	R.62068.2C	
<b>SCION</b>									
<b>xA</b>									
04-07		F R	R.44133	R.44133	R.44133.1S	R.44133.2S	R.44133.1C	R.44133.2C	
<b>xB</b>									
04-07		F R	R.44133	R.44133	R.44133.1S	R.44133.2S	R.44133.1C	R.44133.2C	
08		F R	R.44147	R.44147	R.44147.1S	R.44147.2S	R.44147.1C	R.44147.2C	c
<b>tC</b>									
05-07		F R	R.44114 R.44115	R.44114 R.44115	R.44114.1S R.44115.1S	R.44114.2S R.44115.2S	R.44114.1C R.44115.1C	R.44114.2C R.44115.2C	
<b>SUBARU</b>									
<b>BAJA</b>									
03		F R	R.47018 R.47017	R.47018 R.47017	R.47018.1S R.47017.1S	R.47018.2S R.47017.2S	R.47018.1C R.47017.1C	R.47018.2C R.47017.2C	
04-06	SPORT	F R	R.47018 R.47017	R.47018 R.47017	R.47018.1S R.47017.1S	R.47018.2S R.47017.2S	R.47018.1C R.47017.1C	R.47018.2C R.47017.2C	
04-06	TURBO	F R	R.47021 R.47017	R.47021 R.47017	R.47021.1S R.47017.1S	R.47021.2S R.47017.2S	R.47021.1C R.47017.1C	R.47021.2C R.47017.2C	
<b>FORESTER</b>									
98-2/02	L	F R	R.47012	R.47012	R.47012.1S	R.47012.2S	R.47012.1C	R.47012.2C	
98-2/02	S	F R	R.47012 R.47011	R.47012 R.47011	R.47012.1S R.47011.1S	R.47012.2S R.47011.2S	R.47012.1C R.47011.1C	R.47012.2C R.47011.2C	
3/02-07	2.5X (W/ REAR DRUM)	F R	R.47018	R.47018	R.47018.1S	R.47018.2S	R.47018.1C	R.47018.2C	
3/02-07	2.5XS, 2.5X L, 2.5XT TURBO W/ REAR DISC	F R	R.47018 R.47011	R.47018 R.47011	R.47018.1S R.47011.1S	R.47018.2S R.47011.2S	R.47018.1C R.47011.1C	R.47018.2C R.47011.2C	
<b>IMPREZA COUPE, SEDAN (EXC WRX)</b>									

BRAKE DISC		BASIC OEM		SLOTTED		DRILLED & SLOTTED		NOTES	
		MAKE/MODEL	AXLE	PART #		PART #			PART #
YEAR		F/R	LEFT	RIGHT	LEFT	RIGHT	LEFT	RIGHT	
11/92-8/93	2WD (W/O ABS) W/ REAR DRUM	F R	R.47016	R.47016	R.47016.1S	R.47016.2S	R.47016.1C	R.47016.2C	
11/92-8/93	L (4WD W/O ABS) W/ REAR DRUM	F R	R.47010	R.47010	R.47010.1S	R.47010.2S	R.47010.1C	R.47010.2C	
11/92-8/93	LS (W/ ABS) W/ REAR DISC	F R	R.47010 R.47011	R.47010 R.47011	R.47010.1S R.47011.1S	R.47010.2S R.47011.2S	R.47010.1C R.47011.1C	R.47010.2C R.47011.2C	
9/93-96	2WD (13" WHEEL) W/ REAR DRUM	F R	R.47016	R.47016	R.47016.1S	R.47016.2S	R.47016.1C	R.47016.2C	
9/93-96	2WD (14" WHEEL) W/ REAR DRUM	F R	R.47010	R.47010	R.47010.1S	R.47010.2S	R.47010.1C	R.47010.2C	
9/93-96	L (4WD) W/ REAR DRUM	F R	R.47010	R.47010	R.47010.1S	R.47010.2S	R.47010.1C	R.47010.2C	
9/93-96	LS, LX W/ REAR DISC	F R	R.47010 R.47011	R.47010 R.47011	R.47010.1S R.47011.1S	R.47010.2S R.47011.2S	R.47010.1C R.47011.1C	R.47010.2C R.47011.2C	
97	W/ REAR DRUM	F	R.47010	R.47010	R.47010.1S	R.47010.2S	R.47010.1C	R.47010.2C	
98-01	EXC RS	F R	R.47010	R.47010	R.47010.1S	R.47010.2S	R.47010.1C	R.47010.2C	
98-07	RS	F R	R.47012 R.47011	R.47012 R.47011	R.47012.1S R.47011.1S	R.47012.2S R.47011.2S	R.47012.1C R.47011.1C	R.47012.2C R.47011.2C	
<b>IMPREZA OUTBACK</b>									
95-96	W/O ABS	F R	R.47010	R.47010	R.47010.1S	R.47010.2S	R.47010.1C	R.47010.2C	
95-96	W/ ABS	F R	R.47010 R.47011	R.47010 R.47011	R.47010.1S R.47011.1S	R.47010.2S R.47011.2S	R.47010.1C R.47011.1C	R.47010.2C R.47011.2C	
97-01		F R	R.47010	R.47010	R.47010.1S	R.47010.2S	R.47010.1C	R.47010.2C	
02		F R	R.47012	R.47012	R.47012.1S	R.47012.2S	R.47012.1C	R.47012.2C	
03-07		F R	R.47012 R.47011	R.47012 R.47011	R.47012.1S R.47011.1S	R.47012.2S R.47011.2S	R.47012.1C R.47011.1C	R.47012.2C R.47011.2C	
<b>IMPREZA WAGON (EXC IMPREZA OUTBACK, WRX)</b>									
11/92-8/93	2WD (W/O ABS) W/ REAR DRUM	F R	R.47016	R.47016	R.47016.1S	R.47016.2S	R.47016.1C	R.47016.2C	
11/92-8/93	4WD (W/O ABS) W/ REAR DRUM	F R	R.47010	R.47010	R.47010.1S	R.47010.2S	R.47010.1C	R.47010.2C	
11/92-8/93	2WD & 4WD (W/ ABS) W/ REAR DISC	F R	R.47010 R.47011	R.47010 R.47011	R.47010.1S R.47011.1S	R.47010.2S R.47011.2S	R.47010.1C R.47011.1C	R.47010.2C R.47011.2C	
9/93-96	2WD (13" WHEEL), W/O ABS W/ REAR DRUM	F R	R.47016	R.47016	R.47016.1S	R.47016.2S	R.47016.1C	R.47016.2C	
9/93-96	2WD (14" WHEEL), W/O ABS W/ REAR DRUM	F R	R.47010	R.47010	R.47010.1S	R.47010.2S	R.47010.1C	R.47010.2C	
9/93-96	4WD (W/O ABS) W/ REAR DRUM	F R	R.47010	R.47010	R.47010.1S	R.47010.2S	R.47010.1C	R.47010.2C	
9/93-96	2WD & 4WD (W/ ABS) W/ REAR DISC	F R	R.47010 R.47011	R.47010 R.47011	R.47010.1S R.47011.1S	R.47010.2S R.47011.2S	R.47010.1C R.47011.1C	R.47010.2C R.47011.2C	
97-01	W/ REAR DRUM	F	R.47010	R.47010	R.47010.1S	R.47010.2S	R.47010.1C	R.47010.2C	
02	W/ REAR DRUM	F R	R.47012	R.47012	R.47012.1S	R.47012.2S	R.47012.1C	R.47012.2C	
03-07		F R	R.47012 R.47011	R.47012 R.47011	R.47012.1S R.47011.1S	R.47012.2S R.47011.2S	R.47012.1C R.47011.1C	R.47012.2C R.47011.2C	
<b>IMPREZA (WRX, STI)</b>									
02	WRX	F R	R.47018 R.47011	R.47018 R.47011	R.47018.1S R.47011.1S	R.47018.2S R.47011.2S	R.47018.1C R.47011.1C	R.47018.2C R.47011.2C	
03-04	WRX	F R	R.47018 R.47011	R.47018 R.47011	R.47018.1S R.47011.1S	R.47018.2S R.47011.2S	R.47018.1C R.47011.1C	R.47018.2C R.47011.2C	
03-04	STI (W/ BREMBO CALIPER)	F R	R.47019 R.47020	R.47019 R.47020	R.47019.1S R.47020.1S	R.47019.2S R.47020.2S	R.47019.1C R.47020.1C	R.47019.2C R.47020.2C	
05	WRX	F R	R.47018 R.47011	R.47018 R.47011	R.47018.1S R.47011.1S	R.47018.2S R.47011.2S	R.47018.1C R.47011.1C	R.47018.2C R.47011.2C	
05	STI (W/ BREMBO CALIPER)	F R	R.47022 R.47023	R.47022 R.47023	R.47022.1S R.47023.1S	R.47022.2S R.47023.2S	R.47022.1C R.47023.1C	R.47022.2C R.47023.2C	
06-07	WRX	F R	R.47018 R.47025	R.47018 R.47025	R.47018.1S R.47025.1S	R.47018.2S R.47025.2S	R.47018.1C R.47025.1C	R.47018.2C R.47025.2C	
06-07	STI (W/ BREMBO CALIPER)	F R	R.47022 R.47023	R.47022 R.47023	R.47022.1S R.47023.1S	R.47022.2S R.47023.2S	R.47022.1C R.47023.1C	R.47022.2C R.47023.2C	
<b>LEGACY (SEDAN, WAGON)</b>									

MAKE/MODEL YEAR		AXLE F/R	BASIC OEM		SLOTTED		DRILLED & SLOTTED		NOTES
			PART #		PART #		PART #		
			LEFT	RIGHT	LEFT	RIGHT	LEFT	RIGHT	
90-94		F	R.47010	R.47010	R.47010.1S	R.47010.2S	R.47010.1C	R.47010.2C	
		R	R.47011	R.47011	R.47011.1S	R.47011.2S	R.47011.1C	R.47011.2C	
90-94	4WD TURBO	F	R.47012	R.47012	R.47012.1S	R.47012.2S	R.47012.1C	R.47012.2C	
		R	R.47013	R.47013	R.47013.1S	R.47013.2S	R.47013.1C	R.47013.2C	
95	W/ REAR DRUM	F	R.47010	R.47010	R.47010.1S	R.47010.2S	R.47010.1C	R.47010.2C	
		R							
95	W/ REAR DISC	F	R.47010	R.47010	R.47010.1S	R.47010.2S	R.47010.1C	R.47010.2C	
		R	R.47013	R.47013	R.47013.1S	R.47013.2S	R.47013.1C	R.47013.2C	
96	GT, LSi	F	R.47012	R.47012	R.47012.1S	R.47012.2S	R.47012.1C	R.47012.2C	
		R	R.47011	R.47011	R.47011.1S	R.47011.2S	R.47011.1C	R.47011.2C	
96	L (W/ REAR DRUM)	F	R.47010	R.47010	R.47010.1S	R.47010.2S	R.47010.1C	R.47010.2C	
		R							
96	L, LS (W/ REAR DISC)	F	R.47010	R.47010	R.47010.1S	R.47010.2S	R.47010.1C	R.47010.2C	
		R	R.47011	R.47011	R.47011.1S	R.47011.2S	R.47011.1C	R.47011.2C	
97-99	GT, LS, LTD (W/ REAR DISC)	F	R.47012	R.47012	R.47012.1S	R.47012.2S	R.47012.1C	R.47012.2C	
		R	R.47011	R.47011	R.47011.1S	R.47011.2S	R.47011.1C	R.47011.2C	
97-99	L (W/ REAR DRUM)	F	R.47010	R.47010	R.47010.1S	R.47010.2S	R.47010.1C	R.47010.2C	
		R							
97-99	L (W/ REAR DISC)	F	R.47010	R.47010	R.47010.1S	R.47010.2S	R.47010.1C	R.47010.2C	
		R	R.47011	R.47011	R.47011.1S	R.47011.2S	R.47011.1C	R.47011.2C	
00		F	R.47012	R.47012	R.47012.1S	R.47012.2S	R.47012.1C	R.47012.2C	
		R	R.47017	R.47017	R.47017.1S	R.47017.2S	R.47017.1C	R.47017.2C	
01	L, GT	F	R.47012	R.47012	R.47012.1S	R.47012.2S	R.47012.1C	R.47012.2C	
		R	R.47017	R.47017	R.47017.1S	R.47017.2S	R.47017.1C	R.47017.2C	
01	GT LTD	F	R.47018	R.47018	R.47018.1S	R.47018.2S	R.47018.1C	R.47018.2C	
		R	R.47017	R.47017	R.47017.1S	R.47017.2S	R.47017.1C	R.47017.2C	
02-04	L, LS	F	R.47012	R.47012	R.47012.1S	R.47012.2S	R.47012.1C	R.47012.2C	
		R	R.47017	R.47017	R.47017.1S	R.47017.2S	R.47017.1C	R.47017.2C	
02-04	GT, GT LTD	F	R.47018	R.47018	R.47018.1S	R.47018.2S	R.47018.1C	R.47018.2C	
		R	R.47017	R.47017	R.47017.1S	R.47017.2S	R.47017.1C	R.47017.2C	
05	2.5i	F	R.47012	R.47012	R.47012.1S	R.47012.2S	R.47012.1C	R.47012.2C	
		R	R.47026	R.47026	R.47026.1S	R.47026.2S	R.47026.1C	R.47026.2C	
05	2.5 GT	F	R.47024	R.47024	R.47024.1S	R.47024.2S	R.47024.1C	R.47024.2C	
		R	R.47025	R.47025	R.47025.1S	R.47025.2S	R.47025.1C	R.47025.2C	
06-07	2.5 i	F	R.47021	R.47021	R.47021.1S	R.47021.2S	R.47021.1C	R.47021.2C	
		R	R.47026	R.47026	R.47026.1S	R.47026.2S	R.47026.1C	R.47026.2C	
06-07	2.5 GT	F	R.47024	R.47024	R.47024.1S	R.47024.2S	R.47024.1C	R.47024.2C	
		R	R.47025	R.47025	R.47025.1S	R.47025.2S	R.47025.1C	R.47025.2C	
<b>OUTBACK</b>									
00		F	R.47010	R.47010	R.47010.1S	R.47010.2S	R.47010.1C	R.47010.2C	
		R	R.47017	R.47017	R.47017.1S	R.47017.2S	R.47017.1C	R.47017.2C	
01-04		F	R.47018	R.47018	R.47018.1S	R.47018.2S	R.47018.1C	R.47018.2C	
		R	R.47017	R.47017	R.47017.1S	R.47017.2S	R.47017.1C	R.47017.2C	
05	2.5i, 3.0 R	F	R.47018	R.47018	R.47018.1S	R.47018.2S	R.47018.1C	R.47018.2C	
		R	R.47026	R.47026	R.47026.1S	R.47026.2S	R.47026.1C	R.47026.2C	
05	2.5XT	F	R.47021	R.47021	R.47021.1S	R.47021.2S	R.47021.1C	R.47021.2C	
		R	R.47026	R.47026	R.47026.1S	R.47026.2S	R.47026.1C	R.47026.2C	
06-07	ALL MODEL	F	R.47021	R.47021	R.47021.1S	R.47021.2S	R.47021.1C	R.47021.2C	
		R	R.47026	R.47026	R.47026.1S	R.47026.2S	R.47026.1C	R.47026.2C	
<b>SVX</b>									
92-97		F	R.47014	R.47015	R.47014.1S	R.47015.2S	R.47014.1C	R.47015.2C	
		R	R.47015	R.47015	R.47015.1S	R.47015.2S	R.47015.1C	R.47015.2C	
<b>TRIBECA</b>									
06-07		F	R.47027	R.47027	R.47027.1S	R.47027.2S	R.47027.1C	R.47027.2C	
		R	R.47028	R.47028	R.47028.1S	R.47028.2S	R.47028.1C	R.47028.2C	
<b>SUZUKI</b>									
<b>AERIO</b>									
02-07		F	R.48010	R.48010	R.48010.1S	R.48010.2S	R.48010.1C	R.48010.2C	
		R							
<b>FORENZA</b>									
04-07		F	R.49009	R.49009	R.49009.1S	R.49009.2S	R.49009.1C	R.49009.2C	
		R	R.49010	R.49010	R.49010.1S	R.49010.2S	R.49010.1C	R.49010.2C	
<b>GRAND VITARA (V6)</b>									
99-05		F	R.48008	R.48008	R.48008.1S	R.48008.2S	R.48008.1C	R.48008.2C	
		R							
<b>RENO</b>									
05-07		F	R.49009	R.49009	R.49009.1S	R.49009.2S	R.49009.1C	R.49009.2C	

BRAKE DISC		BASIC OEM		SLOTTED		DRILLED & SLOTTED		NOTES
MAKE/MODEL	AXLE	PART #		PART #		PART #		
YEAR	F/R	LEFT	RIGHT	LEFT	RIGHT	LEFT	RIGHT	
	R	R.49010	R.49010	R.49010.1S	R.49010.2S	R.49010.1C	R.49010.2C	
<b>SWIFT</b>								
90	F	R.48001	R.48001	R.48001.1S	R.48001.2S	R.48001.1C	R.48001.2C	
	R							
90	F	R.48002	R.48002	R.48002.1S	R.48002.2S	R.48002.1C	R.48002.2C	
	R	R.48003	R.48003	R.48003.1S	R.48003.2S	R.48003.1C	R.48003.2C	
91-94	F	R.48001	R.48001	R.48001.1S	R.48001.2S	R.48001.1C	R.48001.2C	
	R							
89-94	F	R.48002	R.48002	R.48002.1S	R.48002.2S	R.48002.1C	R.48002.2C	
	R	R.48003	R.48003	R.48003.1S	R.48003.2S	R.48003.1C	R.48003.2C	
95-01	F	R.48001	R.48001	R.48001.1S	R.48001.2S	R.48001.1C	R.48001.2C	
	R							
<b>SX4</b>								
07	F	R.48012	R.48012	R.48012.1S	R.48012.2S	R.48012.1C	R.48012.2C	
	R	R.48013	R.48013	R.48013.1S	R.48013.2S	R.48013.1C	R.48013.2C	
<b>XL-7</b>								
01-06	F	R.48008	R.48008	R.48008.1S	R.48008.2S	R.48008.1C	R.48008.2C	
	R							
<b>TOYOTA</b>								
<b>AVALON</b>								
95-99	F	R.44079	R.44079	R.44079.1S	R.44079.2S	R.44079.1C	R.44079.2C	
	R	R.44106	R.44106	R.44106.1S	R.44106.2S	R.44106.1C	R.44106.2C	
00-04	F	R.44079	R.44079	R.44079.1S	R.44079.2S	R.44079.1C	R.44079.2C	
	R	R.44117	R.44117	R.44117.1S	R.44117.2S	R.44117.1C	R.44117.2C	
05-07	F	R.44125	R.44125	R.44125.1S	R.44125.2S	R.44125.1C	R.44125.2C	
	R	R.44126	R.44126	R.44126.1S	R.44126.2S	R.44126.1C	R.44126.2C	
<b>CAMRY (COUPE, SEDAN)</b>								
90-91	F	R.44054	R.44054	R.44054.1S	R.44054.2S	R.44054.1C	R.44054.2C	
	R							
90-91	F	R.44054	R.44054	R.44054.1S	R.44054.2S	R.44054.1C	R.44054.2C	
	R	R.44042	R.44042	R.44042.1S	R.44042.2S	R.44042.1C	R.44042.2C	
90-91	F	R.44062	R.44062	R.44062.1S	R.44062.2S	R.44062.1C	R.44062.2C	
	R	R.44042	R.44042	R.44042.1S	R.44042.2S	R.44042.1C	R.44042.2C	
90-91	F	R.44054	R.44054	R.44054.1S	R.44054.2S	R.44054.1C	R.44054.2C	
	R	R.44056	R.44056	R.44056.1S	R.44056.2S	R.44056.1C	R.44056.2C	
92-96	F	R.44078	R.44078	R.44078.1S	R.44078.2S	R.44078.1C	R.44078.2C	
	R							
92-96	F	R.44078	R.44078	R.44078.1S	R.44078.2S	R.44078.1C	R.44078.2C	
	R	R.44085	R.44085	R.44085.1S	R.44085.2S	R.44085.1C	R.44085.2C	
92-96	F	R.44079	R.44079	R.44079.1S	R.44079.2S	R.44079.1C	R.44079.2C	
	R	R.44085	R.44085	R.44085.1S	R.44085.2S	R.44085.1C	R.44085.2C	
97-99	F	R.44078	R.44078	R.44078.1S	R.44078.2S	R.44078.1C	R.44078.2C	
	R							
97-99	F	R.44079	R.44079	R.44079.1S	R.44079.2S	R.44079.1C	R.44079.2C	
	R	R.44085	R.44085	R.44085.1S	R.44085.2S	R.44085.1C	R.44085.2C	
00-01	F	R.44078	R.44078	R.44078.1S	R.44078.2S	R.44078.1C	R.44078.2C	
	R							
00-01	F	R.44079	R.44079	R.44079.1S	R.44079.2S	R.44079.1C	R.44079.2C	
	R							
00-01	F	R.44079	R.44079	R.44079.1S	R.44079.2S	R.44079.1C	R.44079.2C	
	R	R.44085	R.44085	R.44085.1S	R.44085.2S	R.44085.1C	R.44085.2C	
02	F	R.44079	R.44079	R.44079.1S	R.44079.2S	R.44079.1C	R.44079.2C	
	R							
02	F	R.44079	R.44079	R.44079.1S	R.44079.2S	R.44079.1C	R.44079.2C	
	R	R.44126	R.44126	R.44126.1S	R.44126.2S	R.44126.1C	R.44126.2C	
02	F	R.44079	R.44079	R.44079.1S	R.44079.2S	R.44079.1C	R.44079.2C	
	R	R.44126	R.44126	R.44126.1S	R.44126.2S	R.44126.1C	R.44126.2C	
02	F	R.44125	R.44125	R.44125.1S	R.44125.2S	R.44125.1C	R.44125.2C	
	R	R.44126	R.44126	R.44126.1S	R.44126.2S	R.44126.1C	R.44126.2C	
02	F	R.44088	R.44088	R.44088.1S	R.44088.2S	R.44088.1C	R.44088.2C	
	R	R.44126	R.44126	R.44126.1S	R.44126.2S	R.44126.1C	R.44126.2C	
03-04	F	R.44079	R.44079	R.44079.1S	R.44079.2S	R.44079.1C	R.44079.2C	
	R							
03-04	F	R.44079	R.44079	R.44079.1S	R.44079.2S	R.44079.1C	R.44079.2C	
	R	R.44126	R.44126	R.44126.1S	R.44126.2S	R.44126.1C	R.44126.2C	
03-04	F	R.44079	R.44079	R.44079.1S	R.44079.2S	R.44079.1C	R.44079.2C	
	R	R.44126	R.44126	R.44126.1S	R.44126.2S	R.44126.1C	R.44126.2C	



BRAKE DISC		BASIC OEM		SLOTTED		DRILLED & SLOTTED		NOTES	
MAKE/MODEL		AXLE	PART #		PART #		PART #		NOTES
YEAR		F/R	LEFT	RIGHT	LEFT	RIGHT	LEFT	RIGHT	
03-04	6 CYL. (SE, XLE)	F	R.44088	R.44088	R.44088.1S	R.44088.2S	R.44088.1C	R.44088.2C	
		R	R.44126	R.44126	R.44126.1S	R.44126.2S	R.44126.1C	R.44126.2C	
05-06	4 CYL. (LE) W/ REAR DRUM	F	R.44079	R.44079	R.44079.1S	R.44079.2S	R.44079.1C	R.44079.2C	
		R							
05-06	4 CYL. (SE, XLE) W/ REAR DISC	F	R.44079	R.44079	R.44079.1S	R.44079.2S	R.44079.1C	R.44079.2C	
		R	R.44126	R.44126	R.44126.1S	R.44126.2S	R.44126.1C	R.44126.2C	
05-06	6 CYL. (LE)	F	R.44079	R.44079	R.44079.1S	R.44079.2S	R.44079.1C	R.44079.2C	
		R	R.44126	R.44126	R.44126.1S	R.44126.2S	R.44126.1C	R.44126.2C	
05-06	6 CYL. (SE, XLE)	F	R.44125	R.44125	R.44125.1S	R.44125.2S	R.44125.1C	R.44125.2C	
		R	R.44126	R.44126	R.44126.1S	R.44126.2S	R.44126.1C	R.44126.2C	
07		F	R.44146	R.44146	R.44146.1S	R.44146.2S	R.44146.1C	R.44146.2C	C
		R	R.44144	R.44144	R.44144.1S	R.44144.2S	R.44144.1C	R.44144.2C	C
<b>CAMRY SOLARA (SEE SOLARA)</b>									
<b>CELICA</b>									
90-91	GT, CONVERTIBLE	F	R.44064	R.44064	R.44064.1S	R.44064.2S	R.44064.1C	R.44064.2C	
		R							
90-91	GT-S	F	R.44064	R.44064	R.44064.1S	R.44064.2S	R.44064.1C	R.44064.2C	
		R	R.44042	R.44042	R.44042.1S	R.44042.2S	R.44042.1C	R.44042.2C	
90-91	ST	F	R.44063	R.44063	R.44063.1S	R.44063.2S	R.44063.1C	R.44063.2C	
		R							
90-91	ALL TRAC TURBO	F	R.44065	R.44065	R.44065.1S	R.44065.2S	R.44065.1C	R.44065.2C	
		R	R.44066	R.44066	R.44066.1S	R.44066.2S	R.44066.1C	R.44066.2C	
92-93	CONVERTIBLE	F	R.44061	R.44061	R.44061.1S	R.44061.2S	R.44061.1C	R.44061.2C	
		R							
92-93	GT, GT-S	F	R.44065	R.44065	R.44065.1S	R.44065.2S	R.44065.1C	R.44065.2C	
		R	R.44042	R.44042	R.44042.1S	R.44042.2S	R.44042.1C	R.44042.2C	
92-93	ST	F	R.44061	R.44061	R.44061.1S	R.44061.2S	R.44061.1C	R.44061.2C	
		R							
92-93	ALL TRAC TURBO	F	R.44065	R.44065	R.44065.1S	R.44065.2S	R.44065.1C	R.44065.2C	
		R	R.44066	R.44066	R.44066.1S	R.44066.2S	R.44066.1C	R.44066.2C	
94	GT	F	R.44099	R.44099	R.44099.1S	R.44099.2S	R.44099.1C	R.44099.2C	
		R	R.44100	R.44100	R.44100.1S	R.44100.2S	R.44100.1C	R.44100.2C	
94	ST	F	R.44113	R.44113	R.44113.1S	R.44113.2S	R.44113.1C	R.44113.2C	
		R							
95-97	GT, CONVERTIBLE	F	R.44099	R.44099	R.44099.1S	R.44099.2S	R.44099.1C	R.44099.2C	
		R	R.44100	R.44100	R.44100.1S	R.44100.2S	R.44100.1C	R.44100.2C	
95-97	ST	F	R.44113	R.44113	R.44113.1S	R.44113.2S	R.44113.1C	R.44113.2C	
		R							
98-99	GT, CONVERTIBLE, ST	F	R.44099	R.44099	R.44099.1S	R.44099.2S	R.44099.1C	R.44099.2C	
		R	R.44100	R.44100	R.44100.1S	R.44100.2S	R.44100.1C	R.44100.2C	
00	GT	F	R.44113	R.44113	R.44113.1S	R.44113.2S	R.44113.1C	R.44113.2C	
		R							
00	GT-S	F	R.44114	R.44114	R.44114.1S	R.44114.2S	R.44114.1C	R.44114.2C	
		R	R.44115	R.44115	R.44115.1S	R.44115.2S	R.44115.1C	R.44115.2C	
01-05	GT	F	R.44114	R.44114	R.44114.1S	R.44114.2S	R.44114.1C	R.44114.2C	
		R							
01-05	GT-S	F	R.44114	R.44114	R.44114.1S	R.44114.2S	R.44114.1C	R.44114.2C	
		R	R.44115	R.44115	R.44115.1S	R.44115.2S	R.44115.1C	R.44115.2C	
<b>COROLLA</b>									
85-87	COUPE GT-S	F	R.44027	R.44027	R.44027.1S	R.44027.2S	R.44027.1C	R.44027.2C	
	USA MODEL	R	R.44032	R.44032	R.44032.1S	R.44032.2S	R.44032.1C	R.44032.2C	
88-89	COUPE GT-S	F	R.44052	R.44052	R.44052.1S	R.44052.2S	R.44052.1C	R.44052.2C	
		R	R.44053	R.44053	R.44053.1S	R.44053.2S	R.44053.1C	R.44053.2C	
90-91	EXC COUPE GT-S	F	R.44052	R.44052	R.44052.1S	R.44052.2S	R.44052.1C	R.44052.2C	
		R							
90-91	COUPE GT-S	F	R.44047	R.44047	R.44047.1S	R.44047.2S	R.44047.1C	R.44047.2C	
		R	R.44053	R.44053	R.44053.1S	R.44053.2S	R.44053.1C	R.44053.2C	
92		F	R.44052	R.44052	R.44052.1S	R.44052.2S	R.44052.1C	R.44052.2C	
		R							
93-02		F	R.44092	R.44092	R.44092.1S	R.44092.2S	R.44092.1C	R.44092.2C	
		R							
03-04		F	R.44114	R.44114	R.44114.1S	R.44114.2S	R.44114.1C	R.44114.2C	
		R							
05-07	W/ REAR DRUM	F	R.44114	R.44114	R.44114.1S	R.44114.2S	R.44114.1C	R.44114.2C	
		R							
05-06	W/ REAR DISC	F	R.44114	R.44114	R.44114.1S	R.44114.2S	R.44114.1C	R.44114.2C	
		R	R.44115	R.44115	R.44115.1S	R.44115.2S	R.44115.1C	R.44115.2C	
<b>ECHO</b>									

MAKE/MODEL		AXLE	BASIC OEM		SLOTTED		DRILLED & SLOTTED		NOTES
			PART #		PART #		PART #		
YEAR		F/R	LEFT	RIGHT	LEFT	RIGHT	LEFT	RIGHT	
00		F	R.44116	R.44116	R.44116.1S	R.44116.2S	R.44116.1C	R.44116.2C	
		R							
01-05		F	R.44119	R.44119	R.44119.1S	R.44119.2S	R.44119.1C	R.44119.2C	
		R							
<b>FJ CRUISER</b>									
07		F	R.44129	R.44129	R.44129.1S	R.44129.2S	R.44129.1C	R.44129.2C	
		R	R.44128	R.44128	R.44128.1S	R.44128.2S	R.44128.1C	R.44128.2C	
<b>HIGHLANDER</b>									
01-03	2WD	F	R.44088	R.44088	R.44088.1S	R.44088.2S	R.44088.1C	R.44088.2C	
		R	R.44080	R.44080	R.44080.1S	R.44080.2S	R.44080.1C	R.44080.2C	
01-03	4WD	F	R.44088	R.44088	R.44088.1S	R.44088.2S	R.44088.1C	R.44088.2C	
		R	R.44089	R.44089	R.44089.1S	R.44089.2S	R.44089.1C	R.44089.2C	
04-05		F	R.44088	R.44088	R.44088.1S	R.44088.2S	R.44088.1C	R.44088.2C	
		R	R.44131	R.44131	R.44131.1S	R.44131.2S	R.44131.1C	R.44131.2C	
06-07	EXC HYBRID	F	R.44088	R.44088	R.44088.1S	R.44088.2S	R.44088.1C	R.44088.2C	
		R	R.44131	R.44131	R.44131.1S	R.44131.2S	R.44131.1C	R.44131.2C	
06-07	HYBRID	F	R.44130	R.44130	R.44130.1S	R.44130.2S	R.44130.1C	R.44130.2C	
		R	R.44131	R.44131	R.44131.1S	R.44131.2S	R.44131.1C	R.44131.2C	
<b>LANDCRUISER</b>									
90-92		F	R.44073	R.44073	R.44073.1S	R.44073.2S	R.44073.1C	R.44073.2C	
		R							
93-94	W/ REAR DRUM	F	R.44093	R.44093	R.44093.1S	R.44093.2S	R.44093.1C	R.44093.2C	
		R							
93-94	W/ REAR DISC	F	R.44093	R.44093	R.44093.1S	R.44093.2S	R.44093.1C	R.44093.2C	
		R	R.44094	R.44094	R.44094.1S	R.44094.2S	R.44094.1C	R.44094.2C	
95-97		F	R.44093	R.44093	R.44093.1S	R.44093.2S	R.44093.1C	R.44093.2C	
		R	R.44094	R.44094	R.44094.1S	R.44094.2S	R.44094.1C	R.44094.2C	
98-07		F	R.44086	R.44086	R.44086.1S	R.44086.2S	R.44086.1C	R.44086.2C	
		R	R.44087	R.44087	R.44087.1S	R.44087.2S	R.44087.1C	R.44087.2C	
<b>MATRIX</b>									
03-07	XR	F	R.44114	R.44114	R.44114.1S	R.44114.2S	R.44114.1C	R.44114.2C	
		R							
03-06	XRS	F	R.44114	R.44114	R.44114.1S	R.44114.2S	R.44114.1C	R.44114.2C	
		R	R.44115	R.44115	R.44115.1S	R.44115.2S	R.44115.1C	R.44115.2C	
<b>MR 2, MRS SPYDER (EXC TURBO)</b>									
85-86		F	R.44028	R.44028	R.44028.1S	R.44028.2S	R.44028.1C	R.44028.2C	
		R	R.44046	R.44046	R.44046.1S	R.44046.2S	R.44046.1C	R.44046.2C	
87-89		F	R.44047	R.44047	R.44047.1S	R.44047.2S	R.44047.1C	R.44047.2C	
		R	R.44055	R.44055	R.44055.1S	R.44055.2S	R.44055.1C	R.44055.2C	
90-95		F	R.44069	R.44069	R.44069.1S	R.44069.2S	R.44069.1C	R.44069.2C	
		R	R.44072	R.44072	R.44072.1S	R.44072.2S	R.44072.1C	R.44072.2C	
00-05		F	R.44119	R.44119	R.44119.1S	R.44119.2S	R.44119.1C	R.44119.2C	
		R	R.44120	R.44120	R.44120.1S	R.44120.2S	R.44120.1C	R.44120.2C	
<b>MR 2 TURBO</b>									
90-91		F	R.44069	R.44069	R.44069.1S	R.44069.2S	R.44069.1C	R.44069.2C	
		R	R.44072	R.44072	R.44072.1S	R.44072.2S	R.44072.1C	R.44072.2C	
92-95		F	R.44095	R.44095	R.44095.1S	R.44095.2S	R.44095.1C	R.44095.2C	
		R	R.44096	R.44096	R.44096.1S	R.44096.2S	R.44096.1C	R.44096.2C	
<b>PREVIA</b>									
90-4/90	W/ REAR DRUM	F	R.44070	R.44070	R.44070.1S	R.44070.2S	R.44070.1C	R.44070.2C	
		R							
90-4/90	W/ REAR DISC (W/O ABS)	F	R.44071	R.44071	R.44071.1S	R.44071.2S	R.44071.1C	R.44071.2C	
		R	R.44041	R.44041	R.44041.1S	R.44041.2S	R.44041.1C	R.44041.2C	
5/90-93	W/ REAR DRUM	F	R.44070	R.44070	R.44070.1S	R.44070.2S	R.44070.1C	R.44070.2C	
		R							
5/90-93	W/ REAR DISC (W/O ABS)	F	R.44071	R.44071	R.44071.1S	R.44071.2S	R.44071.1C	R.44071.2C	
		R	R.44041	R.44041	R.44041.1S	R.44041.2S	R.44041.1C	R.44041.2C	
5/90-93	W/ REAR DISC (W/ ABS)	F	R.44074	R.44074	R.44074.1S	R.44074.2S	R.44074.1C	R.44074.2C	
		R	R.44041	R.44041	R.44041.1S	R.44041.2S	R.44041.1C	R.44041.2C	
94	MADE IN USA	F	R.44071	R.44071	R.44071.1S	R.44071.2S	R.44071.1C	R.44071.2C	
		R							
94	MADE IN CANADA	F	R.44070	R.44070	R.44070.1S	R.44070.2S	R.44070.1C	R.44070.2C	
		R							
94	W/ REAR DISC (W/O ABS)	F	R.44071	R.44071	R.44071.1S	R.44071.2S	R.44071.1C	R.44071.2C	
		R	R.44041	R.44041	R.44041.1S	R.44041.2S	R.44041.1C	R.44041.2C	
94	W/ REAR DISC (W/ ABS)	F	R.44074	R.44074	R.44074.1S	R.44074.2S	R.44074.1C	R.44074.2C	
		R	R.44041	R.44041	R.44041.1S	R.44041.2S	R.44041.1C	R.44041.2C	
95-96	W/ REAR DRUM	F	R.44071	R.44071	R.44071.1S	R.44071.2S	R.44071.1C	R.44071.2C	

BRAKE DISC		BASIC OEM		SLOTTED		DRILLED & SLOTTED		NOTES	
		AXLE	PART #		PART #		PART #		
MAKE/MODEL	YEAR	F/R	LEFT	RIGHT	LEFT	RIGHT	LEFT	RIGHT	
95-96	W/ REAR DISC	R							
		F	R.44074	R.44074	R.44074.1S	R.44074.2S	R.44074.1C	R.44074.2C	
		R	R.44041	R.44041	R.44041.1S	R.44041.2S	R.44041.1C	R.44041.2C	
95-97	W/ REAR DRUM	F	R.44071	R.44071	R.44071.1S	R.44071.2S	R.44071.1C	R.44071.2C	
		R							
95-97	W/ REAR DISC	F	R.44071	R.44071	R.44071.1S	R.44071.2S	R.44071.1C	R.44071.2C	
		R	R.44041	R.44041	R.44041.1S	R.44041.2S	R.44041.1C	R.44041.2C	
<b>PRIUS</b>									
00-03		F	R.44124	R.44124	R.44124.1S	R.44124.2S	R.44124.1C	R.44124.2C	
		R							
04-07		F	R.44135	R.44135	R.44135.1S	R.44135.2S	R.44135.1C	R.44135.2C	
		R							
<b>RAV 4</b>									
96-00		F	R.44111	R.44111	R.44111.1S	R.44111.2S	R.44111.1C	R.44111.2C	
		R							
01-03	EXC EV	F	R.44121	R.44121	R.44121.1S	R.44121.2S	R.44121.1C	R.44121.2C	
		R							
01-03	EV	F	R.44111	R.44111	R.44111.1S	R.44111.2S	R.44111.1C	R.44111.2C	
		R							
04-05	W/ REAR DRUM	F	R.44121	R.44121	R.44121.1S	R.44121.2S	R.44121.1C	R.44121.2C	
		R							
04-05	W/ REAR DISC	F	R.44121	R.44121	R.44121.1S	R.44121.2S	R.44121.1C	R.44121.2C	
		R	R.44134	R.44134	R.44134.1S	R.44134.2S	R.44134.1C	R.44134.2C	
06-07	2.4L (W/O 3RD ROW SEAT)	F	R.44147	R.44147	R.44147.1S	R.44147.2S	R.44147.1C	R.44147.2C	C
		R	R.44145	R.44145	R.44145.1S	R.44145.2S	R.44145.1C	R.44145.2C	C
06-07	2.4L (W/O 3RD ROW SEAT), 3.5L	F	R.44146	R.44146	R.44146.1S	R.44146.2S	R.44146.1C	R.44146.2C	C
		R	R.44145	R.44145	R.44145.1S	R.44145.2S	R.44145.1C	R.44145.2C	C
<b>SEQUOIA</b>									
01-07		F	R.44118	R.44118	R.44118.1S	R.44118.2S	R.44118.1C	R.44118.2C	
		R	R.44128	R.44128	R.44128.1S	R.44128.2S	R.44128.1C	R.44128.2C	
<b>SIENNA</b>									
98-03		F	R.44079	R.44079	R.44079.1S	R.44079.2S	R.44079.1C	R.44079.2C	
		R							
04-07	W/ REAR DRUM	F	R.44125	R.44125	R.44125.1S	R.44125.2S	R.44125.1C	R.44125.2C	
		R							
04-07	W/ REAR DISC	F	R.44125	R.44125	R.44125.1S	R.44125.2S	R.44125.1C	R.44125.2C	
		R	R.44132	R.44132	R.44132.1S	R.44132.2S	R.44132.1C	R.44132.2C	
<b>SOLARA</b>									
99-03	W/ REAR DRUM	F	R.44079	R.44079	R.44079.1S	R.44079.2S	R.44079.1C	R.44079.2C	
		R							
99-03	W/ REAR DISC	F	R.44079	R.44079	R.44079.1S	R.44079.2S	R.44079.1C	R.44079.2C	
		R	R.44085	R.44085	R.44085.1S	R.44085.2S	R.44085.1C	R.44085.2C	
04-07		F	R.44125	R.44125	R.44125.1S	R.44125.2S	R.44125.1C	R.44125.2C	
		R	R.44126	R.44126	R.44126.1S	R.44126.2S	R.44126.1C	R.44126.2C	
<b>SUPRA</b>									
82-85		F	R.44017	R.44017	R.44017.1S	R.44017.2S	R.44017.1C	R.44017.2C	
		R	R.44018	R.44018	R.44018.1S	R.44018.2S	R.44018.1C	R.44018.2C	
86-92		F	R.44040	R.44040	R.44040.1S	R.44040.2S	R.44040.1C	R.44040.2C	
		R	R.44041	R.44041	R.44041.1S	R.44041.2S	R.44041.1C	R.44041.2C	
93-98	EXC TURBO	F	R.44102	R.44102	R.44102.1S	R.44102.2S	R.44102.1C	R.44102.2C	
		R	R.44084	R.44084	R.44084.1S	R.44084.2S	R.44084.1C	R.44084.2C	
5/93-98	TURBO	F	R.44103	R.44104	R.44103.1S	R.44103.2S	R.44103.1C	R.44103.2C	B
		R	R.44105	R.44105	R.44105.1S	R.44105.2S	R.44105.1C	R.44105.2C	
<b>TERCEL</b>									
91-98		F	R.44075	R.44075	R.44075.1S	R.44075.2S	R.44075.1C	R.44075.2C	
		R							
<b>TACOMA</b>									
95-00	2WD	F	R.44108	R.44108	R.44108.1S	R.44108.2S	R.44108.1C	R.44108.2C	
		R							
95-00	4WD	F	R.44109	R.44109	R.44109.1S	R.44109.2S	R.44109.1C	R.44109.2C	
		R							
01-03	2WD (2.4L) 4 CYL.	F	R.44108	R.44108	R.44108.1S	R.44108.2S	R.44108.1C	R.44108.2C	
		R							
01-03	2WD (2.7L) 4 CYL., 3.4L (V6)	F	R.44109	R.44109	R.44109.1S	R.44109.2S	R.44109.1C	R.44109.2C	
		R							
01-03	4WD	F	R.44109	R.44109	R.44109.1S	R.44109.2S	R.44109.1C	R.44109.2C	
		R							
04	2WD (EXC PRE-RUNNER), 5 LUG	F	R.44108	R.44108	R.44108.1S	R.44108.2S	R.44108.1C	R.44108.2C	

<b>BRAKE DISC</b>		<b>BASIC OEM</b>		<b>SLOTTED</b>		<b>DRILLED &amp; SLOTTED</b>			
<b>MAKE/MODEL</b>		<b>AXLE</b>	<b>PART #</b>		<b>PART #</b>		<b>PART #</b>		<b>NOTES</b>
<b>YEAR</b>		<b>F/R</b>	<b>LEFT</b>	<b>RIGHT</b>	<b>LEFT</b>	<b>RIGHT</b>	<b>LEFT</b>	<b>RIGHT</b>	
04	4WD (PRE-RUNNER) W/O VSC, 6 LUG	R F	R.44109	R.44109	R.44109.1S	R.44109.2S	R.44109.1C	R.44109.2C	
04	4WD (PRE-RUNNER) W/ VSC, 6 LUG	R F	R.44112	R.44112	R.44112.1S	R.44112.2S	R.44112.1C	R.44112.2C	
05-07	2WD (EXC PRE-RUNNER), 5 LUG	R F	R.44136	R.44136	R.44136.1S	R.44136.2S	R.44136.1C	R.44136.2C	
05-07	4WD (PRE-RUNNER) 6 LUG	R F	R.44129	R.44129	R.44129.1S	R.44129.2S	R.44129.1C	R.44129.2C	
<b>TUNDRA</b>									
00-06		R F	R.44118	R.44118	R.44118.1S	R.44118.2S	R.44118.1C	R.44118.2C	
07		R F	R.44156 R.44157	R.44156 R.44157	R.44156.1S R.44157.1S	R.44156.2S R.44157.2S	R.44156.1C R.44157.1C	R.44156.2C R.44157.2C	c c
<b>T100 PICKUP</b>									
93-98	2WD (1/2 TON)	R F	R.44097	R.44097	R.44097.1S	R.44097.2S	R.44097.1C	R.44097.2C	
93-98	2WD (1 TON)	R F	R.44101	R.44101	R.44101.1S	R.44101.2S	R.44101.1C	R.44101.2C	
93-98	4WD	R F	R.44091	R.44091	R.44091.1S	R.44091.2S	R.44091.1C	R.44091.2C	
<b>YARIS</b>									
07		R F	R.44143	R.44143	R.44143.1S	R.44143.2S	R.44143.1C	R.44143.2C	c
<b>4 RUNNER</b>									
89-5/91		R F	R.44044	R.44044	R.44044.1S	R.44044.2S	R.44044.1C	R.44044.2C	
6/91-10/95		R F	R.44091	R.44091	R.44091.1S	R.44091.2S	R.44091.1C	R.44091.2C	
11/95-02	297MM FRONT DISC	R F	R.44109	R.44109	R.44109.1S	R.44109.2S	R.44109.1C	R.44109.2C	
11/95-02	319MM FRONT DISC	R F	R.44112	R.44112	R.44112.1S	R.44112.2S	R.44112.1C	R.44112.2C	
03-07	319MM FRONT DISC	R F	R.44129 R.44128	R.44129 R.44128	R.44129.1S R.44128.1S	R.44129.2S R.44128.2S	R.44129.1C R.44128.1C	R.44129.2C R.44128.2C	
03-07	338MM FRONT DISC	R F	R.44127 R.44128	R.44127 R.44128	R.44127.1S R.44128.1S	R.44127.2S R.44128.2S	R.44127.1C R.44128.1C	R.44127.2C R.44128.2C	
<b>VOLKSWAGEN</b>									
<b>BEETLE (SEE NEW BEETLE)</b>									
<b>CABRIO, CABRIOLET</b>									
84-93		R F	R.33012	R.33012	R.33012.1S	R.33012.2S	R.33012.1C	R.33012.2C	
94-98		R F	R.33023	R.33023	R.33023.1S	R.33023.2S	R.33023.1C	R.33023.2C	
99	W/ REAR DRUM	R F	R.33023	R.33023	R.33023.1S	R.33023.2S	R.33023.1C	R.33023.2C	
99	W/ REAR DISC	R F	R.33023 R.33022	R.33023 R.33022	R.33023.1S R.33022.1S	R.33023.2S R.33022.2S	R.33023.1C R.33022.1C	R.33023.2C R.33022.2C	
00-02	W/ REAR DISC	R F	R.33023 R.33022	R.33023 R.33022	R.33023.1S R.33022.1S	R.33023.2S R.33022.2S	R.33023.1C R.33022.1C	R.33023.2C R.33022.2C	
<b>CORRADO</b>									
89-91	1.8L	R F	R.33028 R.33022	R.33028 R.33022	R.33028.1S R.33022.1S	R.33028.2S R.33022.2S	R.33028.1C R.33022.1C	R.33028.2C R.33022.2C	
92-95	2.8L	R F	R.33034 R.33035	R.33034 R.33035	R.33034.1S R.33035.1S	R.33034.2S R.33035.2S	R.33034.1C R.33035.1C	R.33034.2C R.33035.2C	
<b>EOS</b>									
07		R F	R.33098 R.33099	R.33098 R.33099	R.33098.1S R.33099.1S	R.33098.2S R.33099.2S	R.33098.1C R.33099.1C	R.33098.2C R.33099.2C	c c
<b>GOLF GL, GLS, III, LE (EXC GLS, 1.8 TURBO)</b>									
3/89-92		R F	R.33003	R.33003	R.33003.1S	R.33003.2S	R.33003.1C	R.33003.2C	
93-94	GOLF III	R F	R.33023 R.33022	R.33023 R.33022	R.33023.1S R.33022.1S	R.33023.2S R.33022.2S	R.33023.1C R.33022.1C	R.33023.2C R.33022.2C	
95	W/ REAR DRUM	R F	R.33023	R.33023	R.33023.1S	R.33023.2S	R.33023.1C	R.33023.2C	
95	W/ REAR DISC	R F	R.33023 R.33022	R.33023 R.33022	R.33023.1S R.33022.1S	R.33023.2S R.33022.2S	R.33023.1C R.33022.1C	R.33023.2C R.33022.2C	

BRAKE DISC		BASIC OEM		SLOTTED		DRILLED & SLOTTED		NOTES	
		AXLE	PART #		PART #		PART #		
MAKE/MODEL	YEAR	F/R	LEFT	RIGHT	LEFT	RIGHT	LEFT	RIGHT	
96	TDI (1.9L)	F R	R.33042	R.33042	R.33042.1S	R.33042.2S	R.33042.1C	R.33042.2C	
96-11/98	W/ REAR DRUM	F R	R.33023	R.33023	R.33023.1S	R.33023.2S	R.33023.1C	R.33023.2C	
96-11/98	W/ REAR DISC	F R	R.33023 R.33022	R.33023 R.33022	R.33023.1S R.33022.1S	R.33023.2S R.33022.2S	R.33023.1C R.33022.1C	R.33023.2C R.33022.2C	
97-11/98	CANADA ONLY	F R	R.33003	R.33003	R.33003.1S	R.33003.2S	R.33003.1C	R.33003.2C	
12/98-06		F R	R.33054 R.33057	R.33054 R.33057	R.33054.1S R.33057.1S	R.33054.2S R.33057.2S	R.33054.1C R.33057.1C	R.33054.2C R.33057.2C	
<b>GOLF GTi, GLS TURBO, GLX (VR6), 1.8 TURBO, VR6</b>									
8/89-92	8 VALVE	F R	R.33012	R.33012	R.33012.1S	R.33012.2S	R.33012.1C	R.33012.2C	
8/89-92	16 VALVE	F R	R.33012 R.33022	R.33012 R.33022	R.33012.1S R.33022.1S	R.33012.2S R.33022.2S	R.33012.1C R.33022.1C	R.33012.2C R.33022.2C	
95		F R	R.33034 R.33035	R.33034 R.33035	R.33034.1S R.33035.1S	R.33034.2S R.33035.2S	R.33034.1C R.33035.1C	R.33034.2C R.33035.2C	
96-11/98	2.0L (4 CYL.)	F R	R.33023 R.33022	R.33023 R.33022	R.33023.1S R.33022.1S	R.33023.2S R.33022.2S	R.33023.1C R.33022.1C	R.33023.2C R.33022.2C	
96-11/98	VR6	F R	R.33049 R.33035	R.33049 R.33035	R.33049.1S R.33035.1S	R.33049.2S R.33035.2S	R.33049.1C R.33035.1C	R.33049.2C R.33035.2C	
12/98-02		F R	R.33059 R.33057	R.33059 R.33057	R.33059.1S R.33057.1S	R.33059.2S R.33057.2S	R.33059.1C R.33057.1C	R.33059.2C R.33057.2C	
03-05	1.8 TURBO, 2.8 VR6 W/ SOLID REAR DISC	F R	R.33059 R.33057	R.33059 R.33057	R.33059.1S R.33057.1S	R.33059.2S R.33057.2S	R.33059.1C R.33057.1C	R.33059.2C R.33057.2C	
03-05	1.8 TURBO W/ VENTED REAR DISC	F R	R.33062 R.33069	R.33062 R.33069	R.33062.1S R.33069.1S	R.33062.2S R.33069.2S	R.33062.1C R.33069.1C	R.33062.2C R.33069.2C	
06-07	GTI MK V- 2.0L TURBO	F R	R.33098 R.33099	R.33098 R.33099	R.33098.1S R.33099.1S	R.33098.2S R.33099.2S	R.33098.1C R.33099.1C	R.33098.2C R.33099.2C	C C
<b>GOLF R32 (AWD)</b>									
04		F R	R.33094 R.33069	R.33093 R.33069	R.33094.1S R.33069.1S	R.33094.2S R.33069.2S	R.33094.1C R.33069.1C	R.33094.2C R.33069.2C	A, B
<b>JETTA (EXC JETTA WAGON)</b>									
90-93	W/ REAR DRUM	F R	R.33003	R.33003	R.33003.1S	R.33003.2S	R.33003.1C	R.33003.2C	
90-93	W/ REAR DISC	F R	R.33023 R.33022	R.33023 R.33022	R.33023.1S R.33022.1S	R.33023.2S R.33022.2S	R.33023.1C R.33022.1C	R.33023.2C R.33022.2C	
94-95	W/ REAR DRUM	F R	R.33023	R.33023	R.33023.1S	R.33023.2S	R.33023.1C	R.33023.2C	
94-95	W/ REAR DISC	F R	R.33023 R.33022	R.33023 R.33022	R.33023.1S R.33022.1S	R.33023.2S R.33022.2S	R.33023.1C R.33022.1C	R.33023.2C R.33022.2C	
94-95	VR6	F R	R.33034 R.33035	R.33034 R.33035	R.33034.1S R.33035.1S	R.33034.2S R.33035.2S	R.33034.1C R.33035.1C	R.33034.2C R.33035.2C	
96	1.9 TURBO DIESEL	F R	R.33042	R.33042	R.33042.1S	R.33042.2S	R.33042.1C	R.33042.2C	
96	2.0L GAS (W/ REAR DRUM)	F R	R.33023	R.33023	R.33023.1S	R.33023.2S	R.33023.1C	R.33023.2C	
96	2.0L GAS (W/ REAR DISC)	F R	R.33023 R.33022	R.33023 R.33022	R.33023.1S R.33022.1S	R.33023.2S R.33022.2S	R.33023.1C R.33022.1C	R.33023.2C R.33022.2C	
96	VR6	F R	R.33049 R.33035	R.33049 R.33035	R.33049.1S R.33035.1S	R.33049.2S R.33035.2S	R.33049.1C R.33035.1C	R.33049.2C R.33035.2C	
97-9/98	1.8L GAS, TDI (CANADA ONLY)	F R	R.33003	R.33003	R.33003.1S	R.33003.2S	R.33003.1C	R.33003.2C	
97-9/98	2.0L GAS, TDI (W/ REAR DRUM)	F R	R.33023	R.33023	R.33023.1S	R.33023.2S	R.33023.1C	R.33023.2C	
97-9/98	2.0L GAS (W/ REAR DISC)	F R	R.33023 R.33022	R.33023 R.33022	R.33023.1S R.33022.1S	R.33023.2S R.33022.2S	R.33023.1C R.33022.1C	R.33023.2C R.33022.2C	
97-9/98	VR6	F R	R.33049 R.33035	R.33049 R.33035	R.33049.1S R.33035.1S	R.33049.2S R.33035.2S	R.33049.1C R.33035.1C	R.33049.2C R.33035.2C	
97-9/98	1.8L GAS, TDI (CANADA ONLY)	F R	R.33003	R.33003	R.33003.1S	R.33003.2S	R.33003.1C	R.33003.2C	
10/98-3/04	TDI, 2.0 GAS	F R	R.33054 R.33057	R.33054 R.33057	R.33054.1S R.33057.1S	R.33054.2S R.33057.2S	R.33054.1C R.33057.1C	R.33054.2C R.33057.2C	
10/98-3/04	1.8 TURBO, VR6	F R	R.33059 R.33057	R.33059 R.33057	R.33059.1S R.33057.1S	R.33059.2S R.33057.2S	R.33059.1C R.33057.1C	R.33059.2C R.33057.2C	
04/04-04	TDI, 2.0 GAS	F R	R.33054 R.33057	R.33054 R.33057	R.33054.1S R.33057.1S	R.33054.2S R.33057.2S	R.33054.1C R.33057.1C	R.33054.2C R.33057.2C	
04/04-04	1.8 TURBO, VR6	F	R.33059	R.33059	R.33059.1S	R.33059.2S	R.33059.1C	R.33059.2C	

<b>BRAKE DISC</b>		<b>BASIC OEM</b>		<b>SLOTTED</b>		<b>DRILLED &amp; SLOTTED</b>			
<b>MAKE/MODEL</b>		<b>AXLE</b>	<b>PART #</b>		<b>PART #</b>		<b>PART #</b>		<b>NOTES</b>
<b>YEAR</b>		<b>F/R</b>	<b>LEFT</b>	<b>RIGHT</b>	<b>LEFT</b>	<b>RIGHT</b>	<b>LEFT</b>	<b>RIGHT</b>	
	W/ SOLID REAR DISC	R	R.33057	R.33057	R.33057.1S	R.33057.2S	R.33057.1C	R.33057.2C	
04/04-04	VR6 GLI	F	R.33062	R.33062	R.33062.1S	R.33062.2S	R.33062.1C	R.33062.2C	
	W/ VENTED REAR DISC	R	R.33069	R.33069	R.33069.1S	R.33069.2S	R.33069.1C	R.33069.2C	
05-07	TDI & 2.5 (5 CYL.)	F	R.33110	R.33110	R.33110.1S	R.33110.2S	R.33110.1C	R.33110.2C	c
		R	R.33105	R.33105	R.33105.1S	R.33105.2S	R.33105.1C	R.33105.2C	c
05-07	GLI & 2.0L TURBO	F	R.33098	R.33098	R.33098.1S	R.33098.2S	R.33098.1C	R.33098.2C	c
		R	R.33099	R.33099	R.33099.1S	R.33099.2S	R.33099.1C	R.33099.2C	c
07	CITY (2.0L GAS)	F	R.33054	R.33054	R.33054.1S	R.33054.2S	R.33054.1C	R.33054.2C	
	CANADA ONLY	R	R.33057	R.33057	R.33057.1S	R.33057.2S	R.33057.1C	R.33057.2C	
<b>JETTA WAGON</b>									
01-05	GL, GLS, GLS TDI	F	R.33054	R.33054	R.33054.1S	R.33054.2S	R.33054.1C	R.33054.2C	
		R	R.33057	R.33057	R.33057.1S	R.33057.2S	R.33057.1C	R.33057.2C	
01-05	GLS TURBO, GLS VR6, GLX VR6	F	R.33059	R.33059	R.33059.1S	R.33059.2S	R.33059.1C	R.33059.2C	
		R	R.33057	R.33057	R.33057.1S	R.33057.2S	R.33057.1C	R.33057.2C	
<b>NEW BEETLE</b>									
98-5/99		F	R.33054	R.33054	R.33054.1S	R.33054.2S	R.33054.1C	R.33054.2C	
		R	R.33057	R.33057	R.33057.1S	R.33057.2S	R.33057.1C	R.33057.2C	
6/99-05	EXC TURBO	F	R.33054	R.33054	R.33054.1S	R.33054.2S	R.33054.1C	R.33054.2C	
		R	R.33057	R.33057	R.33057.1S	R.33057.2S	R.33057.1C	R.33057.2C	
6/99-05	TURBO	F	R.33059	R.33059	R.33059.1S	R.33059.2S	R.33059.1C	R.33059.2C	
		R	R.33057	R.33057	R.33057.1S	R.33057.2S	R.33057.1C	R.33057.2C	
06-07	1.9 TDI	F	R.33054	R.33054	R.33054.1S	R.33054.2S	R.33054.1C	R.33054.2C	
		R	R.33057	R.33057	R.33057.1S	R.33057.2S	R.33057.1C	R.33057.2C	
06-07	2.5 (5 CYL.)	F	R.33059	R.33059	R.33059.1S	R.33059.2S	R.33059.1C	R.33059.2C	
		R	R.33057	R.33057	R.33057.1S	R.33057.2S	R.33057.1C	R.33057.2C	
<b>NEW BEETLE (CONVERTIBLE)</b>									
03-05	2.0L GAS	F	R.33054	R.33054	R.33054.1S	R.33054.2S	R.33054.1C	R.33054.2C	
		R	R.33057	R.33057	R.33057.1S	R.33057.2S	R.33057.1C	R.33057.2C	
03-05	TURBO	F	R.33059	R.33059	R.33059.1S	R.33059.2S	R.33059.1C	R.33059.2C	
		R	R.33057	R.33057	R.33057.1S	R.33057.2S	R.33057.1C	R.33057.2C	
06-07	2.5 (5 CYL.)	F	R.33059	R.33059	R.33059.1S	R.33059.2S	R.33059.1C	R.33059.2C	
		R	R.33057	R.33057	R.33057.1S	R.33057.2S	R.33057.1C	R.33057.2C	
<b>PASAT (EXC SYNCRO)</b>									
90-92		F	R.33023	R.33023	R.33023.1S	R.33023.2S	R.33023.1C	R.33023.2C	
		R	R.33022	R.33022	R.33022.1S	R.33022.2S	R.33022.1C	R.33022.2C	
93-95	GL, GLS (4 CYL.)	F	R.33023	R.33023	R.33023.1S	R.33023.2S	R.33023.1C	R.33023.2C	
		R	R.33022	R.33022	R.33022.1S	R.33022.2S	R.33022.1C	R.33022.2C	
93-95	GLX (VR6)	F	R.33034	R.33034	R.33034.1S	R.33034.2S	R.33034.1C	R.33034.2C	
		R	R.33035	R.33035	R.33035.1S	R.33035.2S	R.33035.1C	R.33035.2C	
96-97	TDI (CANADA ONLY)	F	R.33042	R.33042	R.33042.1S	R.33042.2S	R.33042.1C	R.33042.2C	
		R							
96-97	GLS, TDI (USA ONLY)	F	R.33023	R.33023	R.33023.1S	R.33023.2S	R.33023.1C	R.33023.2C	
		R	R.33022	R.33022	R.33022.1S	R.33022.2S	R.33022.1C	R.33022.2C	
96-97	GLX (VR6)	F	R.33049	R.33049	R.33049.1S	R.33049.2S	R.33049.1C	R.33049.2C	
		R	R.33035	R.33035	R.33035.1S	R.33035.2S	R.33035.1C	R.33035.2C	
98-7/98		F	R.33055	R.33055	R.33055.1S	R.33055.2S	R.33055.1C	R.33055.2C	
		R	R.33038	R.33038	R.33038.1S	R.33038.2S	R.33038.1C	R.33038.2C	
7/98-98		F	R.33039	R.33039	R.33039.1S	R.33039.2S	R.33039.1C	R.33039.2C	
		R	R.33038	R.33038	R.33038.1S	R.33038.2S	R.33038.1C	R.33038.2C	
99-01	FWD	F	R.33039	R.33039	R.33039.1S	R.33039.2S	R.33039.1C	R.33039.2C	
		R	R.33038	R.33038	R.33038.1S	R.33038.2S	R.33038.1C	R.33038.2C	
99-01	4-MOTION AWD	F	R.33039	R.33039	R.33039.1S	R.33039.2S	R.33039.1C	R.33039.2C	
		R	R.33047	R.33047	R.33047.1S	R.33047.2S	R.33047.1C	R.33047.2C	
02-05	FWD	F	R.33039	R.33039	R.33039.1S	R.33039.2S	R.33039.1C	R.33039.2C	
		R	R.33038	R.33038	R.33038.1S	R.33038.2S	R.33038.1C	R.33038.2C	
02-05	4-MOTION AWD	F	R.33039	R.33039	R.33039.1S	R.33039.2S	R.33039.1C	R.33039.2C	
		R	R.33047	R.33047	R.33047.1S	R.33047.2S	R.33047.1C	R.33047.2C	
02-05	W8 (4 PAD FRONT CALIPER)	F	R.33077	R.33077	R.33077.1S	R.33077.2S	R.33077.1C	R.33077.2C	c
		R	R.33072	R.33072	R.33072.1S	R.33072.2S	R.33072.1C	R.33072.2C	
06-07	2.0L TURBO, 3.6L (EXC 4-MOTION)	F	R.33098	R.33098	R.33098.1S	R.33098.2S	R.33098.1C	R.33098.2C	c
		R	R.33099	R.33099	R.33099.1S	R.33099.2S	R.33099.1C	R.33099.2C	c
06-07	3.6L (4-MOTION)	F	R.33112	R.33112	R.33112.1S	R.33112.2S	R.33112.1C	R.33112.2C	A
		R	R.33113	R.33113	R.33113.1S	R.33113.2S	R.33113.1C	R.33113.2C	A
<b>PASSAT SYNCRO (CANADA)</b>									
91-93		F	R.33028	R.33028	R.33028.1S	R.33028.2S	R.33028.1C	R.33028.2C	
		R	R.33025	R.33025	R.33025.1S	R.33025.2S	R.33025.1C	R.33025.2C	
<b>PHAETON</b>									
04-06		F	R.33092	R.33092	R.33092.1S	R.33092.2S	R.33092.1C	R.33092.2C	A

BRAKE DISC		BASIC OEM		SLOTTED		DRILLED & SLOTTED		NOTES
MAKE/MODEL	AXLE	PART #		PART #		PART #		
YEAR	F/R	LEFT	RIGHT	LEFT	RIGHT	LEFT	RIGHT	
	R	R.33102	R.33102	R.33102.1S	R.33102.2S	R.33102.1C	R.33102.2C	A
<b>RABBIT</b>								
07	F	R.33110	R.33110	R.33110.1S	R.33110.2S	R.33110.1C	R.33110.2C	C
	R	R.33105	R.33105	R.33105.1S	R.33105.2S	R.33105.1C	R.33105.2C	C
<b>TOUAREG</b>								
04-07	F	R.33080	R.33079	R.33080.1S	R.33080.2S	R.33080.1C	R.33080.2C	B
	R	R.33078	R.33078	R.33078.1S	R.33078.2S	R.33078.1C	R.33078.2C	
04-07	F	R.33090	R.33091	R.33090.1S	R.33090.2S	R.33090.1C	R.33090.2C	B
	R	R.33078	R.33078	R.33078.1S	R.33078.2S	R.33078.1C	R.33078.2C	
<b>VOLVO</b>								
<b>C30</b>								
07	F	R.39037	R.39037	R.39037.1S	R.39037.2S	R.39037.1C	R.39037.2C	C
	R	R.39039	R.39039	R.39039.1S	R.39039.2S	R.39039.1C	R.39039.2C	C
<b>C70</b>								
98-02	F	R.39019	R.39019	R.39019.1S	R.39019.2S	R.39019.1C	R.39019.2C	A
	R	R.39020	R.39020	R.39020.1S	R.39020.2S	R.39020.1C	R.39020.2C	A
98-02	F	R.39023	R.39023	R.39023.1S	R.39023.2S	R.39023.1C	R.39023.2C	A
	R	R.39020	R.39020	R.39020.1S	R.39020.2S	R.39020.1C	R.39020.2C	A
03-04	F	R.39023	R.39023	R.39023.1S	R.39023.2S	R.39023.1C	R.39023.2C	A
	R	R.39020	R.39020	R.39020.1S	R.39020.2S	R.39020.1C	R.39020.2C	A
06-07	F	R.39037	R.39037	R.39037.1S	R.39037.2S	R.39037.1C	R.39037.2C	C
	R	R.39039	R.39039	R.39039.1S	R.39039.2S	R.39039.1C	R.39039.2C	C
<b>S40</b>								
00-04	F	R.39027	R.39027	R.39027.1S	R.39027.2S	R.39027.1C	R.39027.2C	A
	R	R.39028	R.39028	R.39028.1S	R.39028.2S	R.39028.1C	R.39028.2C	A
05-07	F	R.39037	R.39037	R.39037.1S	R.39037.2S	R.39037.1C	R.39037.2C	C
	R	R.39039	R.39039	R.39039.1S	R.39039.2S	R.39039.1C	R.39039.2C	C
05-07	F	R.39038	R.39038	R.39038.1S	R.39038.2S	R.39038.1C	R.39038.2C	C
	R	R.39039	R.39039	R.39039.1S	R.39039.2S	R.39039.1C	R.39039.2C	C
<b>S60</b>								
01-07	F	R.39029	R.39029	R.39029.1S	R.39029.2S	R.39029.1C	R.39029.2C	A
	R	R.39025	R.39025	R.39025.1S	R.39025.2S	R.39025.1C	R.39025.2C	A
01-07	F	R.39026	R.39026	R.39026.1S	R.39026.2S	R.39026.1C	R.39026.2C	A
	R	R.39025	R.39025	R.39025.1S	R.39025.2S	R.39025.1C	R.39025.2C	A
<b>S70</b>								
98	F	R.39023	R.39023	R.39023.1S	R.39023.2S	R.39023.1C	R.39023.2C	A
	R	R.39020	R.39020	R.39020.1S	R.39020.2S	R.39020.1C	R.39020.2C	A
99-00	F	R.39023	R.39023	R.39023.1S	R.39023.2S	R.39023.1C	R.39023.2C	A
	R	R.39020	R.39020	R.39020.1S	R.39020.2S	R.39020.1C	R.39020.2C	A
99-00	F	R.39023	R.39023	R.39023.1S	R.39023.2S	R.39023.1C	R.39023.2C	A
	R	R.39024	R.39024	R.39024.1S	R.39024.2S	R.39024.1C	R.39024.2C	A
99-00	F	R.39023	R.39023	R.39023.1S	R.39023.2S	R.39023.1C	R.39023.2C	A
	R	R.39030	R.39030	R.39030.1S	R.39030.2S	R.39030.1C	R.39030.2C	A
<b>S80</b>								
99-06	F	R.39026	R.39026	R.39026.1S	R.39026.2S	R.39026.1C	R.39026.2C	A
	R	R.39025	R.39025	R.39025.1S	R.39025.2S	R.39025.1C	R.39025.2C	A
<b>S90</b>								
97-98	F	R.39019	R.39019	R.39019.1S	R.39019.2S	R.39019.1C	R.39019.2C	A
	R	R.39022	R.39022	R.39022.1S	R.39022.2S	R.39022.1C	R.39022.2C	A
<b>V40</b>								
00-04	F	R.39027	R.39027	R.39027.1S	R.39027.2S	R.39027.1C	R.39027.2C	A
	R	R.39028	R.39028	R.39028.1S	R.39028.2S	R.39028.1C	R.39028.2C	A
<b>V50</b>								
05-07	F	R.39037	R.39037	R.39037.1S	R.39037.2S	R.39037.1C	R.39037.2C	C
	R	R.39039	R.39039	R.39039.1S	R.39039.2S	R.39039.1C	R.39039.2C	C
05-07	F	R.39038	R.39038	R.39038.1S	R.39038.2S	R.39038.1C	R.39038.2C	C
	R	R.39039	R.39039	R.39039.1S	R.39039.2S	R.39039.1C	R.39039.2C	C
<b>V70, V70 R (EXC XC)</b>								
98	F	R.39019	R.39019	R.39019.1S	R.39019.2S	R.39019.1C	R.39019.2C	A
	R	R.39020	R.39020	R.39020.1S	R.39020.2S	R.39020.1C	R.39020.2C	A
98	F	R.39023	R.39023	R.39023.1S	R.39023.2S	R.39023.1C	R.39023.2C	A
	R	R.39020	R.39020	R.39020.1S	R.39020.2S	R.39020.1C	R.39020.2C	A
98	F	R.39019	R.39019	R.39019.1S	R.39019.2S	R.39019.1C	R.39019.2C	A
	R	R.39024	R.39024	R.39024.1S	R.39024.2S	R.39024.1C	R.39024.2C	A
98	F	R.39023	R.39023	R.39023.1S	R.39023.2S	R.39023.1C	R.39023.2C	A
	R	R.39024	R.39024	R.39024.1S	R.39024.2S	R.39024.1C	R.39024.2C	A
99	F	R.39019	R.39019	R.39019.1S	R.39019.2S	R.39019.1C	R.39019.2C	A

BRAKE DISC		BASIC OEM		SLOTTED		DRILLED & SLOTTED		NOTES
MAKE/MODEL	AXLE	PART #		PART #		PART #		
YEAR	F/R	LEFT	RIGHT	LEFT	RIGHT	LEFT	RIGHT	
	R	R.39020	R.39020	R.39020.1S	R.39020.2S	R.39020.1C	R.39020.2C	A
99	2WD (302MM FRONT DISC)	F R.39023	R.39023	R.39023.1S	R.39023.2S	R.39023.1C	R.39023.2C	A
	R	R.39020	R.39020	R.39020.1S	R.39020.2S	R.39020.1C	R.39020.2C	A
99	AWD (CHASSIS # 588639), 280MM DISC	F R.39019	R.39019	R.39019.1S	R.39019.2S	R.39019.1C	R.39019.2C	A
	R	R.39024	R.39024	R.39024.1S	R.39024.2S	R.39024.1C	R.39024.2C	A
99	AWD (CHASSIS # 588639), 302MM DISC	F R.39023	R.39023	R.39023.1S	R.39023.2S	R.39023.1C	R.39023.2C	A
	R	R.39024	R.39024	R.39024.1S	R.39024.2S	R.39024.1C	R.39024.2C	A
99	AWD (CHASSIS # 588640), 280MM DISC	F R.39019	R.39019	R.39019.1S	R.39019.2S	R.39019.1C	R.39019.2C	A
	R	R.39030	R.39030	R.39030.1S	R.39030.2S	R.39030.1C	R.39030.2C	A
99	AWD (CHASSIS # 588640), 302MM DISC	F R.39023	R.39023	R.39023.1S	R.39023.2S	R.39023.1C	R.39023.2C	A
	R	R.39030	R.39030	R.39030.1S	R.39030.2S	R.39030.1C	R.39030.2C	A
00	2WD (280MM FRONT DISC)	F R.39019	R.39019	R.39019.1S	R.39019.2S	R.39019.1C	R.39019.2C	A
	R	R.39020	R.39020	R.39020.1S	R.39020.2S	R.39020.1C	R.39020.2C	A
00	2WD (302MM FRONT DISC)	F R.39023	R.39023	R.39023.1S	R.39023.2S	R.39023.1C	R.39023.2C	A
	R	R.39020	R.39020	R.39020.1S	R.39020.2S	R.39020.1C	R.39020.2C	A
00	AWD (280MM FRONT DISC)	F R.39019	R.39019	R.39019.1S	R.39019.2S	R.39019.1C	R.39019.2C	A
	R	R.39030	R.39030	R.39030.1S	R.39030.2S	R.39030.1C	R.39030.2C	A
00	AWD (302MM FRONT DISC)	F R.39023	R.39023	R.39023.1S	R.39023.2S	R.39023.1C	R.39023.2C	A
	R	R.39030	R.39030	R.39030.1S	R.39030.2S	R.39030.1C	R.39030.2C	A
00	R	F R.39023	R.39023	R.39023.1S	R.39023.2S	R.39023.1C	R.39023.2C	A
	R	R.39031	R.39031	R.39031.1S	R.39031.2S	R.39031.1C	R.39031.2C	A
01-07	EXC T5	F R.39029	R.39029	R.39029.1S	R.39029.2S	R.39029.1C	R.39029.2C	A
	R	R.39025	R.39025	R.39025.1S	R.39025.2S	R.39025.1C	R.39025.2C	A
01-07	T5	F R.39026	R.39026	R.39026.1S	R.39026.2S	R.39026.1C	R.39026.2C	A
	R	R.39025	R.39025	R.39025.1S	R.39025.2S	R.39025.1C	R.39025.2C	A
<b>V70 XC AWD</b>								
98-00	280MM FRONT DISC	F R.39019	R.39019	R.39019.1S	R.39019.2S	R.39019.1C	R.39019.2C	A
	GIRLING REAR CALIPER	R R.39024	R.39024	R.39024.1S	R.39024.2S	R.39024.1C	R.39024.2C	A
98-00	302MM FRONT DISC	F R.39023	R.39023	R.39023.1S	R.39023.2S	R.39023.1C	R.39023.2C	A
	GIRLING REAR CALIPER	R R.39024	R.39024	R.39024.1S	R.39024.2S	R.39024.1C	R.39024.2C	A
99-00	280MM FRONT DISC	F R.39019	R.39019	R.39019.1S	R.39019.2S	R.39019.1C	R.39019.2C	A
	ATE REAR CALIPER	R R.39030	R.39030	R.39030.1S	R.39030.2S	R.39030.1C	R.39030.2C	A
99-00	302MM FRONT DISC	F R.39023	R.39023	R.39023.1S	R.39023.2S	R.39023.1C	R.39023.2C	A
	ATE REAR CALIPER	R R.39030	R.39030	R.39030.1S	R.39030.2S	R.39030.1C	R.39030.2C	A
01-02		F R.39029	R.39029	R.39029.1S	R.39029.2S	R.39029.1C	R.39029.2C	A
		R R.39025	R.39025	R.39025.1S	R.39025.2S	R.39025.1C	R.39025.2C	A
<b>V90</b>								
97-98		F R.39019	R.39019	R.39019.1S	R.39019.2S	R.39019.1C	R.39019.2C	A
		R R.39022	R.39022	R.39022.1S	R.39022.2S	R.39022.1C	R.39022.2C	A
<b>XC70 AWD</b>								
03-07		F R.39029	R.39029	R.39029.1S	R.39029.2S	R.39029.1C	R.39029.2C	A
		R R.39025	R.39025	R.39025.1S	R.39025.2S	R.39025.1C	R.39025.2C	A
<b>XC90</b>								
03-06	2.5L (2WD), 2.9L (6 CYL. 2WD, AWD)	F R.39032	R.39032	R.39032.1S	R.39032.2S	R.39032.1C	R.39032.2C	A
	316MM FRONT DISC	R R.39033	R.39033	R.39033.1S	R.39033.2S	R.39033.1C	R.39033.2C	A
03-06	2.9L (6 CYL. AWD), 4.4L (V8 AWD)	F R.39034	R.39034	R.39034.1S	R.39034.2S	R.39034.1C	R.39034.2C	A
	336MM FRONT DISC	R R.39033	R.39033	R.39033.1S	R.39033.2S	R.39033.1C	R.39033.2C	A
07	3.2L (6 CYL. 2WD, AWD)	F R.39032	R.39032	R.39032.1S	R.39032.2S	R.39032.1C	R.39032.2C	A
	316MM FRONT DISC	R R.39033	R.39033	R.39033.1S	R.39033.2S	R.39033.1C	R.39033.2C	A
07	4.4L (V8 AWD)	F R.39034	R.39034	R.39034.1S	R.39034.2S	R.39034.1C	R.39034.2C	A
	336MM FRONT DISC	R R.39033	R.39033	R.39033.1S	R.39033.2S	R.39033.1C	R.39033.2C	A

**NOTES:**

A=SPECIAL ORDER FOR SLOTTED AND DRILLED & SLOTTED BRAKE DISCS (LEAD TIME 7-10 DAYS DEPENDING ON APPLICATION)

B=DIRECTIONAL VENTED DISCS

C=NEW (CONTACT ROTORA FOR AVAILABILITY)

D=BASIC OEM DISC DRILLED ONLY

**GENERAL INFORMATION:**

ALL PRICES ARE PER SINGLE DISC

LEFT: DRIVER SIDE, RIGHT: PASSENGER SIDE (NORTH AMERICA)

UNLESS OTHERWISE SPECIFIED, ALL BRAKE DISCS ARE FOR NORTH AMERICAN VEHICLES

IF ANY APPLICATIONS YOU ARE IN NEED THAT ARE NOT LISTED, PLEASE CONTACT ROTORA FOR FURTHER ASSISTANCE

CERTAIN BRAKE DISCS ARE NOT E-COAT PLATED



# BRAKE PAD

AXXIS PAD CERAMIC PAD

MAKE/MODEL	AXLE	ULTIMATE	H2	NOTES
YEAR	F/R	PART #	PART #	
<b>ACURA</b>				
<b>CL COUPE</b>				
97 2.2L (4 CYL.)	F	AP.04650	RP.04650.1	
	R	AP.05370	RP.05370.1	
97 3.0L (V6)	F	AP.05030	RP.05030.1	
	R	AP.05370	RP.05370.1	
98-99 2.3L (4 CYL.)	F	AP.04650	RP.04650.1	
	R	AP.05370	RP.05370.1	
98-99 3.0L (V6)	F	AP.05030	RP.05030.1	
	R	AP.05370	RP.05370.1	
01-03 3.2L (V6)	F	AP.07870	RP.07870.1	
	R	AP.05360	RP.05360.1	
<b>CSX (CANADA)</b>				
06-07 CXS (2.0L)	F	AP.07870	RP.07870.1	
	R	AP.05370	RP.05370.1	
07 CSX TYPE-S (2.0L)	F	AP.08290	RP.08290.1	
	R	AP.05370	RP.05370.1	
<b>EL (CANADA)</b>				
97-00	F	AP.07640	RP.07640.1	
	R			
01-05	F	AP.07640	RP.07640.1	
	R	AP.05370	RP.05370.1	
06	F	AP.07870	RP.07870.1	
	R	AP.05370	RP.05370.1	
<b>INTEGRA</b>				
86-89	F	AP.03340		
	R			
90-93	F	AP.04090	RP.04090.1	
	R	AP.03740	RP.03740.1	
94-96	F	AP.06170	RP.06170.1	
	R	AP.03740	RP.03740.1	
97-01 EXC TYPE R	F	AP.06170	RP.06170.1	
	R	AP.03740	RP.03740.1	
97-01 TYPE R	F	AP.05030	RP.05030.1	
	R	AP.05370	RP.05370.1	
<b>LEGEND</b>				
89-90	F	AP.04090	RP.04090.1	
	R	AP.05370	RP.05370.1	
91-95	F	AP.05030	RP.05030.1	
	R	AP.05360	RP.05360.1	
<b>MDX</b>				
03-06	F	AP.06910	RP.06910.1	
	R			
<b>NSX</b>				
91-05	F	AP.05030	RP.05030.1	
	R	AP.05040		
<b>RDX</b>				
07	F		RP.10890.1	
	R	AP.05360	RP.05360.1	
<b>RL</b>				
96-98	F	AP.05030	RP.05030.1	
	R	AP.05360	RP.05360.1	
99-04	F	AP.07870	RP.07870.1	
	R	AP.05360	RP.05360.1	
<b>RSX</b>				
02-06 EXC TYPE-S	F	AP.06210	RP.06210.1	
	R	AP.05370	RP.05370.1	
02-06 TYPE-S	F	AP.08290	RP.08290.1	
	R	AP.05370	RP.05370.1	
<b>SLX</b>				
96-99	F	AP.05790		
	R	AP.05800		
<b>TL</b>				
95-98 2.5L, 3.2L	F	AP.05030	RP.05030.1	
	R	AP.05370	RP.05370.1	
99-03	F	AP.07870	RP.07870.1	
	R	AP.05360	RP.05360.1	
04-07 EXC BREMBO CALIPER	F	AP.07870	RP.07870.1	

# BRAKE PAD

AXXIS PAD CERAMIC PAD

MAKE/MODEL	AXLE	ULTIMATE	H2	NOTES
YEAR	F/R	PART #	PART #	
04-07 W/ BREMBO CALIPER	R F R	AP.05360 AP.10010 AP.05360	RP.05360.1 RP.10010.1 RP.05360.1	
<b>TSX</b>				
04-07	F R	AP.07870 AP.05370	RP.07870.1 RP.05370.1	
<b>AUDI</b>				
<b>ALLROAD</b>				
01-06 2 PAD FRONT CALIPER	F R	AP.03400	RP.03400.1	
01-06 4 PAD FRONT CALIPER (2.7L V6, 4.2L V8)	F R	AP.08390 AP.03400	RP.03400.1	
<b>A3</b>				
06-08	F R		RP.11070.1 RP.11080.1	
<b>A4 (EXC QUATTRO)</b>				
96-2/97	F R	AP.07360 AP.02280		
3/97-1/99	F R	AP.07360 AP.03400	RP.03400.1	
2/99-04 ALL MODEL	F R	AP.08400 AP.03400	RP.08400.1 RP.03400.1	
05-06 1.8L, 3.0L	F R	AP.08400 AP.03400	RP.08400.1 RP.03400.1	
05-06 2.0L TURBO, 3.2L	F R		RP.09151.1 RP.11080.1	
07	F R		RP.09151.1 RP.11080.1	
<b>A4 QUATTRO</b>				
96-1/99	F R	AP.07360 AP.02280		
2/99-01	F R	AP.08400 AP.02280	RP.08400.1	
02-04 ALL MODEL	F R	AP.08400 AP.03400	RP.08400.1 RP.03400.1	
05-06 3.0 CABRIOLET ONLY	F R	AP.08400 AP.03400	RP.08400.1 RP.03400.1	
05-07 2.0L TURBO, 3.2L	F R		RP.09151.1 RP.11080.1	
07	F R		RP.09151.1 RP.11080.1	
<b>A6 (EXC QUATTRO)</b>				
95-98 W/ AFC ENG	F R	AP.05550 AP.02280		
98-04 ALL MODEL	F R	AP.08400 AP.03400	RP.08400.1 RP.03400.1	
05-07	F R		RP.09151.1 RP.11080.1	
<b>A6 QUATTRO</b>				
95-98	F R	AP.05550 AP.02280		
98-6/99	F R	AP.08400 AP.03400	RP.08400.1 RP.03400.1	
7/99-01 15", 16" WHEEL (EXC 2.7 TURBO, 4.2L V8)	F R	AP.08400 AP.03400	RP.08400.1 RP.03400.1	
7/99-01 2.7L TURBO, 4.2L V8	F R	AP.08390 AP.03400	RP.03400.1	
02-04 2.7L TURBO (W/ 2 PAD FRONT CALIPER), 3.0L	F R	AP.03400	RP.03400.1	
02-04 2.7L TURBO (W/ 4 PAD FRONT CALIPER), 4.2L V8	F R	AP.08390 AP.03400	RP.03400.1	
05-07 3.2L	F R		RP.09151.1 RP.11080.1	
05-07 4.2L (V8)	F R		RP.09151.1	
<b>A8, A8 QUATTRO</b>				
97-8/99	F			

# BRAKE PAD

AXXIS PAD CERAMIC PAD

MAKE/MODEL	AXLE	ULTIMATE	H2	NOTES
YEAR	F/R	PART #	PART #	
9/99-03	R	AP.02280		
	F	AP.08391		
	R	AP.03400	RP.03400.1	
<b>CABRIOLET (SEE A4 FROM 2002)</b>				
94-98	F	AP.04190		
	R	AP.02280		
<b>S4</b>				
92-94	F			
	R	AP.02280		
2/99-02	F	AP.08390		
	R	AP.03400	RP.03400.1	
04-07	F		RP.09151.1	
	R			
<b>S6</b>				
95-98	F			
	R	AP.02280		
02-04	F	AP.08390		
	R	AP.03400	RP.03400.1	
<b>TT (EXC QUATTRO)</b>				
3/99-6/99 W/O PAD SENSOR	F	AP.06870		
	R	AP.03400	RP.03400.1	
3/99-6/99 W/ PAD SENSOR	F	AP.06871		
	R	AP.03400	RP.03400.1	
7/99-06	F	AP.06871		
	R	AP.03400	RP.03400.1	
08	F		RP.11070.1	
	R		RP.11080.1	
<b>TT QUATTRO</b>				
01-06 180 HP, 225 HP	F	AP.06871		
	R	AP.03400	RP.03400.1	
04-06 3.2L (V6)	F	AP.06820		
	R	AP.03400	RP.03400.1	
07 3.2L (V6)	F			
	R		RP.11080.1	
<b>BENTLEY</b>				
<b>ARNAGE</b>				
98-05 GREEN LABEL	F			
	R	AP.06830	RP.06830.1	
98-05 RED LABEL, R, RL, T	F	AP.06820		
	R	AP.09190		
<b>BMW</b>				
<b>M3</b>				
87-91 E30	F	AP.02530		
	R	AP.03960	RP.03960.1	
95-99 E36	F	AP.03940	RP.03940.1	
	R	AP.03960	RP.03960.1	
01-07 E46 (EXC COMPETITION PKG)	F	AP.03940	RP.03940.1	
	R	AP.06830	RP.06830.1	
06-07 E46 (W/ COMPETITION PKG)	F			
	R	AP.06830	RP.06830.1	
<b>M5</b>				
89-93	F	AP.03940	RP.03940.1	
	R	AP.03960	RP.03960.1	
00-04	F	AP.06810	RP.06810.1	
	R	AP.06830	RP.06830.1	
06	F			
	R	AP.09190		
<b>X3</b>				
04-07	F	AP.09460		
	R	AP.06830	RP.06830.1	
<b>X5</b>				
00-01	F	AP.06810	RP.06810.1	
	R	AP.06830	RP.06830.1	
02-03 3.0i, 4.4i	F	AP.06810	RP.06810.1	
	R	AP.06830	RP.06830.1	
02-03 4.6is	F	AP.09200		

# BRAKE PAD

AXXIS PAD CERAMIC PAD

MAKE/MODEL		AXLE	ULTIMATE	H2	NOTES
YEAR		F/R	PART #	PART #	
		R	AP.06830	RP.06830.1	
04	3.0i, 4.4i	F	AP.06810	RP.06810.1	
		R	AP.06830	RP.06830.1	
05-06	3.0i, 4.4i	F	AP.06810	RP.06810.1	
		R	AP.06830	RP.06830.1	
05-06	4.8is	F	AP.09200		
		R	AP.06830	RP.06830.1	
<b>Z3</b>					
96-97		F	AP.05580	RP.05580.1	
		R	AP.06920	RP.06920.1	
98-02	EXC M SERIES	F	AP.05580	RP.05580.1	
		R	AP.06920	RP.06920.1	
98-02	M SERIES	F	AP.03940	RP.03940.1	
		R	AP.03960	RP.03960.1	
<b>Z4</b>					
03-1/06		F	AP.05580	RP.05580.1	
		R	AP.06920	RP.06920.1	
2/06-07	3.0i	F	AP.05580	RP.05580.1	
		R	AP.06920	RP.06920.1	
2/06-07	3.0Si	F	AP.09460		
		R	AP.06920	RP.06920.1	
<b>Z8 (ALPINA ROADSTER)</b>					
00-03		F	AP.06820		
		R	AP.06830	RP.06830.1	
<b>318i, iS</b>					
90-4/91	E30	F	AP.04930		
		R	AP.02790		
11/91-98	E36	F	AP.05580	RP.05580.1	
		R	AP.06920	RP.06920.1	
<b>318Ti</b>					
95-99		F	AP.05580	RP.05580.1	
		R	AP.06920	RP.06920.1	
<b>323 SERIES (E36, E46)</b>					
98-00	ALL MODEL	F	AP.05580	RP.05580.1	
		R	AP.06920	RP.06920.1	
<b>325, 328 SERIES (E30, E36)</b>					
89-9/90	ALL MODEL	F	AP.04930		
		R	AP.02790		
10/90-4/91	E30	F	AP.04930		
		R	AP.02790		
10/90-4/91	E36	F	AP.05580	RP.05580.1	
		R	AP.06920	RP.06920.1	
5/91-99		F	AP.05580	RP.05580.1	
		R	AP.06920	RP.06920.1	
<b>325 SERIES (E46)</b>					
01-07	E46	F	AP.05580	RP.05580.1	
		R	AP.06920	RP.06920.1	
<b>328 SERIES (E46)</b>					
99-00		F	AP.05580	RP.05580.1	
		R	AP.06920	RP.06920.1	
<b>330 SERIES (E46)</b>					
00-07	E46	F	AP.09460		
		R	AP.06830	RP.06830.1	
<b>335 SERIES (E90, E92)</b>					
07		F	AP.09180		
		R			
<b>525i</b>					
89-95		F	AP.03940	RP.03940.1	
		R	AP.03960	RP.03960.1	
01-03		F	AP.07250	RP.07250.1	
		R	AP.06921	RP.06921.1	
04-05	M/T	F	AP.07250	RP.07250.1	
		R	AP.06830	RP.06830.1	
04-05	A/T	F	AP.09180		
		R	AP.06830	RP.06830.1	
06-07		F	AP.09180		
		R	AP.06830	RP.06830.1	
<b>528i</b>					

# BRAKE PAD

AXXIS PAD CERAMIC PAD

MAKE/MODEL	AXLE	ULTIMATE	H2	NOTES
YEAR	F/R	PART #	PART #	
96-00	F R	AP.07250 AP.06921	RP.07250.1 RP.06921.1	
<b>530i</b>				
93-95	F R	AP.03940 AP.03960	RP.03940.1 RP.03960.1	
01-03	F R	AP.06810 AP.06921	RP.06810.1 RP.06921.1	
04-07	F R	AP.09180 AP.06830	RP.06830.1	
<b>535i, is</b>				
89-93	F R	AP.03940 AP.03960	RP.03940.1 RP.03960.1	
<b>540i</b>				
93-95	F R	AP.03940 AP.03960	RP.03940.1 RP.03960.1	
96-03	F R	AP.06810 AP.06921	RP.06810.1 RP.06921.1	
<b>545i, 550i (E60)</b>				
04-07	F R	AP.09180 AP.09190		
<b>645i, Ci (E63, E64)</b>				
04-07	F R	AP.09180 AP.09190		
<b>730i</b>				
92-93	F R	AP.03940 AP.03960	RP.03940.1 RP.03960.1	
<b>735, 735i, 735iL</b>				
3/88-92	F R	AP.03940 AP.03960	RP.03940.1 RP.03960.1	
<b>740i, 740iL</b>				
93-4/94	F R	AP.03940 AP.03960	RP.03940.1 RP.03960.1	
5/94-01	F R	AP.06810 AP.06830	RP.06810.1 RP.06830.1	
<b>745i (E65), 745Li (E66)</b>				
02-05	F R	AP.09180 AP.09190		
<b>750i, 750iL (E32, E38), 750i, 750Li (E65, E66)</b>				
88-94	F R	AP.03940 AP.03960	RP.03940.1 RP.03960.1	
95-01	F R	AP.06820 AP.06830	RP.06830.1	
06-07 E65, E66	F R	AP.09180 AP.09190		
<b>760i (E65), 760Li (E66)</b>				
03-07	F R	AP.09180 AP.09190		
<b>840Ci</b>				
94-97	F R	AP.06830	RP.06830.1	
<b>850Ci, 850i</b>				
8/93-97	F R	AP.06830	RP.06830.1	
<b>850CSi</b>				
94-95	F R	AP.06830	RP.06830.1	
<b>BUICK</b>				
<b>CENTURY</b>				
90-96	F R	AP.02150		
<b>LeSABRE</b>				
90-91	F R	AP.02150		
<b>RAINER</b>				
04-05	F R		RP.08820.1 RP.08830.1	
06-07	F		RP.11690.1	

# BRAKE PAD

AXXIS PAD CERAMIC PAD

MAKE/MODEL	AXLE	ULTIMATE	H2	NOTES
YEAR	F/R	PART #	PART #	
	R		RP.08830.1	
<b>REGAL</b>				
88-96	F R	AP.03760		
<b>SKYLARK</b>				
90 EXC PERFORMANCE PKG	F R	AP.02890		
90 W/ PERFORMANCE PKG	F R	AP.05060	RP.05060.1	
91-98 W/ PERFORMANCE PKG	F R	AP.05060	RP.05060.1	
<b>CADILLAC</b>				
<b>CTS-V</b>				
04-07 W/ BREMBO CALIPER	F R	AP.10010	RP.10010.1 RP.10530.1	
<b>DEVILLE, DEVILLE CONCOURS</b>				
90-93 HD	F R	AP.03690		
<b>DTS</b>				
06-07 HEARSE & LIMO (HD)	F R		RP.07840.1 RP.07920.1	
<b>ESCALADE</b>				
99-01	F R	AP.03690		
02	F R		RP.07850.1 RP.08340.1	
03-06 2WD	F R		RP.07850.1 RP.09741.1	
03-06 4WD	F R		RP.07850.1 RP.08340.1	
07	F R		RP.10920.1 RP.11940.1	
<b>SEVILLE, STS, SLS</b>				
06-07 STS-V SERIES, W/ BREMBO CALIPER	F R	AP.10010	RP.10010.1 RP.10530.1	
<b>XLR</b>				
04-07 ALL MODEL	F R		RP.07310.1 RP.07320.1	
<b>CHEVROLET</b>				
<b>ASTRO VAN</b>				
85-02 2WD	F R	AP.00520		
90-02 4WD	F R	AP.03690		
03-05 2WD, 4WD	F R		RP.07850.1 RP.07920.1	
<b>AVALANCHE 1500</b>				
02 W/ LIMITED SLIP AXLE	F R		RP.07850.1 RP.08340.1	
02 W/O LIMITED SLIP AXLE	F R		RP.07850.1 RP.07920.1	
03-06 2WD	F R		RP.07850.1 RP.09741.1	
03-06 4WD	F R		RP.07850.1 RP.08340.1	
07	F R		RP.10920.1 RP.11940.1	
<b>AVALANCHE 2500</b>				
02-07	F R		RP.07840.1 RP.07850.1	
<b>BERETTA</b>				
92-96	F R	AP.05060	RP.05060.1	
<b>CAMARO</b>				
89-92 W/ REAR DISC	F R	AP.01540 AP.04130	RP.04130.1	

# BRAKE PAD

AXXIS PAD CERAMIC PAD

MAKE/MODEL	AXLE	ULTIMATE	H2	NOTES
YEAR	F/R	PART #	PART #	
89-92 W/ 1LE PERFORMANCE PKG	F R	AP.04120 AP.04130	RP.04120.1 RP.04130.1	
98-02	F R	AP.07490		
<b>CAPRICE</b>				
90-93 W/ REAR DRUM (EXC POLICE, HD)	F R	AP.00520		
94-96 W/ REAR DRUM (W/ 9" REAR DRUM BRAKE)	F R	AP.00520		
<b>CAVALIER</b>				
92-05	F R	AP.05060	RP.05060.1	
<b>COBALT</b>				
05-07	F R		RP.10280.1	
<b>CORSICA</b>				
92-96	F R	AP.05060	RP.05060.1	
<b>CORVETTE</b>				
89-96	F R	AP.04120 AP.04130	RP.04120.1 RP.04130.1	
97-06 ALL MODEL (EXC Z06)	F R		RP.07310.1 RP.07320.1	
06-07 Z06	F R		RP.11850.1 RP.11851.1	
<b>C1500 SERIES (1/2 TON) PICKUP 2WD</b>				
88-99	F R	AP.03690		
<b>C2500 SERIES (3/4 TON) PICKUP 2WD</b>				
88-98 11" REAR DRUM BRAKE	F R	AP.03690		
<b>EXPRESS 1500 (1/2 TON) VAN</b>				
96-02	F R	AP.03690		
03-07	F R		RP.07850.1 RP.09741.1	
<b>EXPRESS 2500 (3/4 TON) VAN</b>				
96-02 6 LUG (7300 LBS. GVW)	F R	AP.03690		
03-05 7300 LBS. GVW	F R		RP.07850.1 RP.09740.1	
03-05 8500 LBS. GVW PANEL 8600 LBS. GVW PASS	F R		RP.07840.1 RP.09740.1	
06-07	F R		RP.07840.1 RP.09740.1	
<b>EXPRESS 3500 (1 TON) VAN</b>				
03-07 SRW	F R		RP.07840.1 RP.09740.1	
03-07 DRW	F R		RP.07840.1	
<b>LUMINA</b>				
90-01 W/ REAR DRUM	F R	AP.03760		
<b>MALIBU, MALIBU MAXX</b>				
97-03 OLD BODY SYTLE (CLASSIC SEDAN ONLY)	F R	AP.07270		
04-05 OLD BODY SYTLE	F R	AP.07270		
04-05 NEW BODY STYLE	F R		RP.10280.1	
06-07	F R		RP.10280.1	
<b>MONTE CARLO</b>				
95-99 W/ REAR DRUM	F R	AP.03760		
95-99 W/ REAR DISC	F R	AP.03760		
<b>PRIZM</b>				

# BRAKE PAD

AXXIS PAD CERAMIC PAD

MAKE/MODEL		AXLE	ULTIMATE	H2	NOTES
YEAR		F/R	PART #	PART #	
98-02		F R	AP.07410		
<b>SILVERADO 1500 (1/2 TON) 2WD</b>					
99-00		F R		RP.07850.1 RP.07920.1	
01	2 DR	F R		RP.07850.1 RP.07920.1	
01	4 DR (HD)	F R		RP.07840.1 RP.07850.1	
02	REG CAB, 2 WHEEL STEERING	F R		RP.07850.1 RP.07920.1	
02	EXT CAB, 4 WHEEL STEERING	F R		RP.07850.1 RP.08340.1	
02	4 DR (HD)	F R		RP.07840.1 RP.07850.1	
03	REG CAB	F R		RP.07850.1 RP.07920.1	
03	EXT CAB, 2 WHEEL STEERING	F R		RP.07850.1 RP.07920.1	
03	EXT CAB, 4 WHEEL STEERING 330MM REAR DISC	F R		RP.07850.1 RP.08340.1	
03	EXT CAB, 4 WHEEL STEERING 325MM REAR DISC	F R		RP.07850.1 RP.07920.1	
03	CREW CAB (4 DR), HD, 2 WHEEL STEERING	F R		RP.07840.1 RP.07850.1	
03	CREW CAB (4 DR), HD, 4 WHEEL STEERING	F R		RP.07840.1 RP.07920.1	
04	REG CAB	F R		RP.07850.1 RP.07920.1	
04	CREW CAB	F R		RP.07850.1 RP.08340.1	
04	EXT CAB, 2 WHEEL STEERING EXC HYBRID ELECTRIC	F R		RP.07850.1 RP.07920.1	
04	EXT CAB, 4 WHEEL STEERING EXC HYBRID ELECTRIC	F R		RP.07850.1 RP.08340.1	
04	EXT CAB, HYBRID ELECTRIC	F R		RP.07850.1 RP.07920.1	
04	EXT CAB (HD)	F R		RP.07840.1 RP.07850.1	
05	REG CAB, EXT CAB, CREW CAB (EXC HD) W/ REAR DRUM	F R		RP.10920.1	
05	CREW CAB (HD) W/O QUADRASTEER	F R		RP.07840.1 RP.07850.1	
05	CREW CAB (4 DR), HD, 2 WHEEL STEERING W/ QUADRASTEER	F R		RP.07840.1 RP.08340.1	
05	EXT CAB, HYBRID ELECTRIC	F R		RP.07850.1 RP.07920.1	
06	REG CAB, EXT CAB, CREW CAB (EXC HD) W/ REAR DRUM	F R		RP.10920.1	
06	REG CAB, EXT CAB, ELECTRIC HYBRID (EXC HD) W/ REAR DISC	F R		RP.07850.1 RP.07920.1	
06	CREW CAB (HD)	F R		RP.07840.1 RP.07850.1	
06	EXT CAB (SS-6.0L V8)	F R		RP.07850.1 RP.08340.1	
07	W/ REAR DRUM	F R		RP.10920.1	
07	W/ REAR DISC	F R		RP.10920.1 RP.11940.1	
<b>SILVERADO 1500 (1/2 TON) 4WD</b>					
99-00		F R		RP.07850.1 RP.07920.1	
01-02	REG CAB, 2 WHEEL STEERING	F R		RP.07850.1 RP.07920.1	
01-02	EXT CAB, 4 WHEEL STEERING	F R		RP.07850.1 RP.08340.1	
01-02	4 DR (HD)	F R		RP.07840.1 RP.07850.1	



# BRAKE PAD

AXXIS PAD CERAMIC PAD

MAKE/MODEL		AXLE	ULTIMATE	H2	NOTES
YEAR		F/R	PART #	PART #	
03	EXT CAB, REG CAB, 2 WHEEL STEERING	F		RP.07850.1	
		R		RP.07920.1	
03	EXT CAB, 4 WHEEL STEERING 330MM REAR DISC	F		RP.07850.1	
		R		RP.08340.1	
03	EXT CAB, 4 WHEEL STEERING 325MM REAR DISC	F		RP.07850.1	
		R		RP.07920.1	
03	4 DR (HD); 2 WHEEL STEERING	F		RP.07840.1	
		R		RP.07850.1	
03	4 DR (HD); 4 WHEEL STEERING	F		RP.07840.1	
		R		RP.08340.1	
04	REG CAB	F		RP.07850.1	
		R		RP.07920.1	
04	CREW CAB	F		RP.07850.1	
		R		RP.08340.1	
04	EXT CAB, 2 WHEEL STEERING EXC HYBRID ELECTRIC	F		RP.07850.1	
		R		RP.07920.1	
04	EXT CAB, 4 WHEEL STEERING EXC HYBRID ELECTRIC	F		RP.07850.1	
		R		RP.08340.1	
04	EXT CAB, HYBRID ELECTRIC	F		RP.07850.1	
		R		RP.07920.1	
04	EXT CAB (HD)	F		RP.07840.1	
		R		RP.07850.1	
04	EXT CAB (SS-6.0L V8)	F		RP.07850.1	
		R		RP.08340.1	
05	REG CAB, EXT CAB, CREW CAB (EXC HD) W/ REAR DRUM	F		RP.10920.1	
		R			
05	CREW CAB (HD) W/O QUADRASTEER	F		RP.07840.1	
		R		RP.07850.1	
05	CREW CAB (4 DR), HD, 2 WHEEL STEERING W/ QUADRASTEER	F		RP.07840.1	
		R		RP.08340.1	
05	EXT CAB, HYBRID ELECTRIC	F		RP.07850.1	
		R		RP.07920.1	
05	EXT CAB (SS-6.0L V8)	F		RP.07850.1	
		R		RP.08340.1	
06	REG CAB, EXT CAB, CREW CAB (EXC HD) W/ REAR DRUM	F		RP.10920.1	
		R			
06	REG CAB, EXT CAB (EXC HD) W/ REAR DISC	F		RP.07850.1	
		R		RP.07920.1	
06	CREW CAB (HD)	F		RP.07840.1	
		R		RP.07850.1	
06	EXT CAB (SS-6.0L V8)	F		RP.07850.1	
		R		RP.08340.1	
07	W/ REAR DRUM	F		RP.10920.1	
		R			
07	W/ REAR DISC	F		RP.10920.1	
		R		RP.11940.1	
<b>SILVERADO 2500 (3/4 TON) 2WD &amp; 4WD</b>					
99-07		F		RP.07840.1	
		R		RP.07850.1	
<b>SILVERADO 3500 (1 TON) 2WD</b>					
01-05		F		RP.07840.1	
		R		RP.09090.1	
06-07	SRW	F		RP.07840.1	
		R		RP.07850.1	
06-07	DRW	F		RP.07840.1	
		R		RP.09090.1	
<b>SILVERADO 3500 (1 TON) 4WD</b>					
01-03		F		RP.07840.1	
		R		RP.09090.1	
04-07	SRW	F		RP.07840.1	
		R		RP.07850.1	
04-07	DRW	F		RP.07840.1	
		R		RP.09090.1	
<b>SSR</b>					
03-05		F		RP.08820.1	
		R		RP.08830.1	
06-07		F		RP.11690.1	
		R		RP.08830.1	

# BRAKE PAD

AXXIS PAD CERAMIC PAD

MAKE/MODEL	AXLE	ULTIMATE	H2	NOTES
YEAR	F/R	PART #	PART #	
<b>SUBURBAN 1500 (1/2 TON) 2WD</b>				
74-91	F	AP.00520		
	R			
92-00 11" REAR DRUM BRAKE	F	AP.03690		
	R			
00-02 W/ LIMITED SLIP AXLE	F		RP.07850.1	
	R		RP.08340.1	
00-02 W/O LIMITED SLIP AXLE	F		RP.07850.1	
	R		RP.07920.1	
03-06	F		RP.07850.1	
	R		RP.09740.1	
07	F		RP.10920.1	
	R		RP.11940.1	
<b>SUBURBAN 1500 (1/2 TON) 4WD</b>				
74-91	F	AP.00520		
	R			
92-00 11" REAR DRUM BRAKE	F	AP.03690		
	R			
00-02 W/ LIMITED SLIP AXLE	F		RP.07850.1	
	R		RP.08340.1	
00-02 W/O LIMITED SLIP AXLE	F		RP.07850.1	
	R		RP.07920.1	
03-06	F		RP.07850.1	
	R		RP.08340.1	
07	F		RP.10920.1	
	R		RP.11940.1	
<b>SUBURBAN 2500 (3/4 TON) 2WD &amp; 4WD</b>				
00-02 W/ REAR DISC	F		RP.07840.1	
	R		RP.07850.1	
03-05 2 WHEEL STEERING	F		RP.07840.1	
	R		RP.07850.1	
03-05 4 WHEEL STEERING	F		RP.07840.1	
	R		RP.07920.1	
06-07	F		RP.07840.1	
	R		RP.07850.1	
<b>S-10 BLAZER SUV (2WD &amp; 4WD)</b>				
89-97	F	AP.01540		
	R			
98-05	F		RP.07260.1	
	R		RP.07290.1	
<b>S-10 PICKUP (2WD)</b>				
89-03	F	AP.01540		
	R			
04	F		RP.07260.1	
	R		RP.07290.1	
<b>S-10 PICKUP (4WD)</b>				
89-97	F	AP.01540		
	R			
98-04	F		RP.07260.1	
	R		RP.07290.1	
<b>TAHOE 2WD</b>				
95-00 EXC POLICE & PERFORMANCE PKG W/ REAR DRUM	F	AP.03690		
	R			
00-01 W/ REAR DISC	F		RP.07850.1	
	R		RP.08340.1	
02 CLASSIC STYLE	F		RP.07850.1	
	R		RP.08340.1	
02 NEW STYLE	F		RP.07850.1	
	R		RP.09741.1	
03-06	F		RP.07850.1	
	R		RP.09741.1	
07	F		RP.10920.1	
	R		RP.11940.1	
<b>TAHOE 4WD</b>				
95-00 11" REAR DRUM BRAKE	F	AP.03690		
	R			
00-02 W/ LIMITED SLIP AXLE	F		RP.07850.1	
	R		RP.08340.1	

# BRAKE PAD

AXXIS PAD CERAMIC PAD

MAKE/MODEL	AXLE	ULTIMATE	H2	NOTES
YEAR	F/R	PART #	PART #	
00-02 W/O LIMITED SLIP AXLE	F		RP.07850.1	
	R		RP.07920.1	
03-06	F		RP.07850.1	
	R		RP.08340.1	
07	F		RP.10920.1	
	R		RP.11940.1	
<b>TRAILBLAZER</b>				
02-05	F		RP.08820.1	
	R		RP.08830.1	
06-07	F		RP.11690.1	
	R		RP.08830.1	
<b>CHRYSLER</b>				
<b>ASPEN</b>				
07	F		RP.10840.1	
	R		RP.08980.1	
<b>CROSSFIRE</b>				
04-05 EXC SRT-6	F	AP.07400		
	R	AP.07790		
06 SRT-6	F	AP.06820		
	R	AP.06030		
<b>SEBRING CONVERTIBLE</b>				
08 ALL MODEL	F	AP.08660	RP.08660.1	
	R			
<b>SEBRING COUPE</b>				
95-00	F	AP.04840	RP.04840.1	
	R	AP.03830	RP.03830.1	
01-05 4 CYL.	F	AP.04840	RP.04840.1	
	R			
01-05 6 CYL.	F	AP.08660	RP.08660.1	
	R	AP.03830	RP.03830.1	
<b>SEBRING SEDAN</b>				
07 ALL MODEL	F	AP.08660	RP.08660.1	
	R			
<b>300, 300C</b>				
05 300, TOURING, LIMITED (2.7L, 3.5L) W/ SOLID REAR DISC	F		RP.10560.1	
	R		RP.10570.1	
05 300C (5.7L) W/ VENTED REAR DISC	F		RP.10580.1	
	R		RP.10570.1	
06-07 300, TOURING, LIMITED (2.7L, 3.5L), 2WD W/ SOLID REAR DISC	F		RP.10560.1	
	R		RP.10570.1	
06-07 300, TOURING, LIMITED (3.5L), AWD W/ VENTED REAR DISC	F		RP.10580.1	
	R		RP.10570.1	
06-07 300C (5.7L), 2WD & AWD W/ VENTED REAR DISC	F		RP.10580.1	
	R		RP.10570.1	
06-07 SRT-8	F		RP.11490.1	
	R		RP.10530.1	
<b>DODGE</b>				
<b>AVENGER</b>				
95-00	F	AP.04840	RP.04840.1	
	R	AP.03830	RP.03830.1	
08 ALL MODEL	F	AP.08660	RP.08660.1	
	R			
<b>CALIBER</b>				
07 ALL MODEL	F	AP.08660	RP.08660.1	
	R			
<b>CHARGER</b>				
06-07 DAYTONA R/T (5.7L V8) W/ VENTED REAR DISC	F		RP.10580.1	
	R		RP.10571.1	
06-07 SE (3.5L, V8) W/ SOLID REAR DISC	F		RP.10560.1	
	R		RP.10570.1	
06-07 SXT (3.5L V6), R/T (5.7L V8) W/ VENTED REAR DISC	F		RP.10580.1	
	R		RP.10570.1	
06-07 SRT-8	F		RP.11490.1	
	R		RP.10530.1	
<b>DAKOTA</b>				
05-07 2WD, 4WD	F		RP.10840.1	

# BRAKE PAD

AXXIS PAD CERAMIC PAD

MAKE/MODEL	AXLE	ULTIMATE	H2	NOTES
YEAR	F/R	PART #	PART #	
	R			
<b>DURANGO</b>				
03	F		RP.07020.1	
	R			
04-06	F		RP.08970.1	
	R		RP.08980.1	
07	F		RP.10840.1	
	R		RP.08980.1	
<b>INTREPID</b>				
93-04	F	AP.05910		
	R			
<b>MAGNUM</b>				
05 SE, SXT (2.7L V6, 3.5L V6) W/ SOLID REAR DISC	F		RP.10560.1	
	R		RP.10570.1	
05 RT (5.7L V8) W/ VENTED REAR DISC	F		RP.10580.1	
	R		RP.10570.1	
06-07 SE, SXT (2.7L V6, 3.5L V6) 2WD W/ SOLID REAR DISC	F		RP.10560.1	
	R		RP.10570.1	
06-07 SXT (3.5L V6) AWD, R/T (5.7L V8) 2WD, AWD W/ VENTED REAR DISC	F		RP.10580.1	
	R		RP.10570.1	
06-07 SRT-8	F		RP.11490.1	
	R		RP.10530.1	
<b>RAM 1500 PICKUP (2WD &amp; 4WD)</b>				
94-99	F	AP.03690		
	R			
00-01	F		RP.07020.1	
	R			
02-05	F		RP.08970.1	
	R		RP.08980.1	
06-07 REG CAB, QUAD CAB	F		RP.10840.1	
	R		RP.08980.1	
06-07 MEGA CAB	F		RP.09650.1	
	R		RP.07021.1	
<b>RAM 2500 PICKUP (2WD &amp; 4WD)</b>				
00-7/00 W/ REAR DRUM	F		RP.08210.1	
	R			
7/00-02 W/ REAR DISC	F		RP.08210.1	
	R		RP.07021.1	
03-07	F		RP.09650.1	
	R		RP.07021.1	
<b>RAM 3500 PICKUP (2WD &amp; 4WD)</b>				
00-7/00 W/ REAR DRUM	F		RP.08210.1	
	R			
7/00-02 W/ REAR DISC	F		RP.08210.1	
	R		RP.07021.1	
03-07	F		RP.09650.1	
	R		RP.07021.1	
<b>RAM SRT-10</b>				
04-06	F			
	R		RP.07020.1	
<b>STEALTH</b>				
91-96 2WD	F	AP.05300	RP.05300.1	
	R	AP.03830	RP.03830.1	
<b>STRATUS COUPE</b>				
01-05 4 CYL.	F	AP.04840	RP.04840.1	
	R			
01-05 V6	F	AP.08660	RP.08660.1	
	R	AP.03830	RP.03830.1	
<b>VIPER</b>				
01-02	F			
	R		RP.08060.1	
<b>EAGLE</b>				
<b>TALON (EXC TURBO)</b>				
90-94	F	AP.04840	RP.04840.1	
	R	AP.03290	RP.03290.1	
95-96	F	AP.04840	RP.04840.1	
	R	AP.03830	RP.03830.1	

# BRAKE PAD

AXXIS PAD CERAMIC PAD

MAKE/MODEL	AXLE	ULTIMATE	H2	NOTES
YEAR	F/R	PART #	PART #	
97-99	F R	AP.04840	RP.04840.1	
<b>TALON (TSI TURBO)</b>				
90-92	F R	AP.04840 AP.03290	RP.04840.1 RP.03290.1	
93 2WD	F R	AP.04840 AP.03290	RP.04840.1 RP.03290.1	
93 4WD	F R	AP.05300 AP.03290	RP.05300.1 RP.03290.1	
94 2WD	F R	AP.04840 AP.03290	RP.04840.1 RP.03290.1	
94 4WD	F R	AP.05300 AP.05320	RP.05300.1 RP.05320.1	
94-11/94 2WD (FJ MODEL)	F R	AP.04840 AP.03830	RP.04840.1 RP.03830.1	
94-11/94 4WD (FJ MODEL) W/ VENTED REAR DISC	F R	AP.05300 AP.05320	RP.05300.1 RP.05320.1	
12/94-97 2WD (FJ MODEL)	F R	AP.04840 AP.03830	RP.04840.1 RP.03830.1	
12/94-97 4WD (FJ MODEL) W/ SOLID REAR DISC	F R	AP.05300 AP.03830	RP.05300.1 RP.03830.1	
98-99 2WD	F R	AP.04840 AP.03830	RP.04840.1 RP.03830.1	
98-99 4WD	F R	AP.05300 AP.03830	RP.05300.1 RP.03830.1	
<b>FORD</b>				
<b>ESCORT, ZX2</b>				
91-96 DOHC 1.8L	F R	AP.04730 AP.04580	RP.04730.1 RP.04580.1	
91-96 SOHC 1.9L (CALIPER CAST#22-13)	F R	AP.04660		
93-96 SOHC 1.9L (CALIPER CAST#22-14)	F R	AP.04730	RP.04730.1	
97-03 W/ REAR DRUM	F R	AP.04730	RP.04730.1	
97-03 W/ REAR DISC	F R	AP.04730 AP.06360	RP.04730.1 RP.06360.1	
<b>EXCURSION</b>				
99-05	F R		RP.07560.1 RP.07570.1	
<b>EXPEDITION</b>				
97-3/02	F R		RP.07020.1 RP.07110.1	
3/02-06	F R		RP.09340.1 RP.09350.1	
07	F R		RP.12780.1 RP.12790.1	
<b>EXPLORER (EXC SPORT, SPORT TRAC)</b>				
91-94	F R	AP.03870		
95-01	F R	AP.06520 AP.06670		
<b>F150 (1/2 TON) PICKUP 2WD</b>				
97-12/98 W/ REAR DRUM	F R		RP.06790.1	
97-12/98 W/ REAR DISC (LIGHTNING)	F R		RP.07020.1 RP.07110.1	
12/98-11/99 W/ REAR DRUM	F R		RP.06790.1	
12/98-11/99 W/ REAR DISC (EXC LIGHTNING)	F R		RP.06790.1 RP.07110.1	
12/98-11/99 W/ REAR DISC (LIGHTNING)	F R		RP.07020.1 RP.07110.1	
12/99-11/04 W/ REAR DRUM (5 LUG)	F R		RP.06790.1	
12/99-11/04 W/ REAR DRUM (7 LUG)	F R		RP.07020.1	

# BRAKE PAD

AXXIS PAD CERAMIC PAD

MAKE/MODEL	AXLE	ULTIMATE	H2	NOTES
YEAR	F/R	PART #	PART #	
12/99-11/04 W/ REAR DISC (5 LUG), EXC LIGHTNING	F R		RP.06790.1 RP.07110.1	
12/99-11/04 W/ REAR DISC (5 LUG), LIGHTNING	F R		RP.07020.1 RP.07110.1	
12/99-11/04 W/ REAR DISC (7 LUG)	F R		RP.07020.1 RP.07110.1	
12/99-11/04 W/ REAR DISC (8 LUG)	F R		RP.07020.1 RP.08020.1	
04-11/04 NEW MODEL	F R		RP.10110.1 RP.10120.1	
11/04-07	F R		RP.10110.1 RP.10120.1	
<b>F150 (1/2 TON) PICKUP 4WD</b>				
97-11/99 W/ REAR DRUM	F R		RP.06790.1	
12/98-11/99 W/ REAR DISC	F R		RP.06790.1 RP.07110.1	
12/99-03 W/ REAR DRUM (5 LUG)	F R		RP.06790.1	
12/99-03 W/ REAR DRUM (7 LUG)	F R		RP.07020.1	
12/99-03 W/ REAR DISC (5 LUG)	F R		RP.06790.1 RP.07110.1	
12/99-03 W/ REAR DISC (7 LUG)	F R		RP.07020.1 RP.07110.1	
04-11/04 NEW MODEL	F R		RP.10110.1 RP.10120.1	
12/99-11/04 W/ REAR DRUM (5 LUG)	F R		RP.06790.1	
12/99-11/04 W/ REAR DRUM (7 LUG)	F R		RP.07020.1	
12/99-11/04 W/ REAR DISC (5 LUG)	F R		RP.06790.1 RP.07110.1	
12/99-11/04 W/ REAR DISC (7 LUG)	F R		RP.07020.1 RP.07110.1	
11/04-07	F R		RP.10110.1 RP.10120.1	
<b>F250 (3/4 TON) 2WD &amp; 4WD PICKUP (EXC SUPER DUTY)</b>				
95-96 W/ REAR DRUM	F R		RP.06550.1	
97-99 W/ REAR DRUM (7 LUG)	F R		RP.07020.1	
97-99 W/ REAR DRUM (8 LUG)	F R		RP.06550.1	
97-99 W/ REAR DISC (EXC HD)	F R		RP.07020.1 RP.07110.1	
99-04 W/ REAR DISC (HD)	F R		RP.07560.1 RP.07570.1	
05-08 DRW, SRW	F R		RP.10690.1 RP.10680.1	
<b>F350 (1 TON) SUPER DUTY 2WD &amp; 4WD</b>				
95-98 W/ REAR DRUM	F R		RP.06550.1	
99-04	F R		RP.07560.1 RP.07570.1	
05-08 SRW	F R		RP.10690.1 RP.10680.1	
05-08 DRW	F R		RP.10690.1 RP.10670.1	
<b>FOCUS (EXC SVT)</b>				
00	F R	AP.08160		
01-04	F R	AP.08160		
05-07	F R	AP.10440	RP.10440.1	
<b>FUSION</b>				
06-07	F		RP.11640.1	

# BRAKE PAD

AXXIS PAD CERAMIC PAD

MAKE/MODEL	AXLE	ULTIMATE	H2	NOTES
YEAR	F/R	PART #	PART #	
	R		RP.11610.1	
<b>GT</b>				
05-06	F	AP.10010	RP.10010.1	
	R	AP.10010	RP.10010.1	
<b>MUSTANG</b>				
94-98 EXC COBRA	F		RP.06000.1	
	R		RP.06270.1	
94-98 COBRA	F	AP.04120	RP.04120.1	
	R		RP.06271.1	
99-04 EXC COBRA	F		RP.08040.1	
	R		RP.06270.1	
99-04 COBRA	F	AP.04120	RP.04120.1	
	R		RP.06271.1	
05-07 V6 (4.0L), GT V8 (4.6L)	F		RP.10810.1	
	R		RP.10820.1	
07 SHELBY	F	AP.10010	RP.10010.1	
	R		RP.10820.1	
<b>PROBE</b>				
93-97	F	AP.06370	RP.06370.1	
	R	AP.05840	RP.05840.1	
<b>RANGER 2WD</b>				
01-04	F	AP.06520		
	R	AP.06670		
<b>RANGER 4WD</b>				
95-02	F	AP.06520		
	R			
<b>TAURUS</b>				
94-00	F	AP.06010		
	R	AP.06100		
01-05	F			
	R	AP.06100		
<b>TAURUS SHO</b>				
94-95	F	AP.06010		
	R	AP.06100		
96-99	F			
	R	AP.06100		
<b>THUNDERBIRD</b>				
93-97 EXC SPORT PACKAGE	F		RP.06000.1	
	R			
02-05	F	AP.08050		
	R	AP.08060		
<b>GMC TRUCK, VAN</b>				
<b>C1500 SERIES (1/2 TON) PICKUP 2WD</b>				
89-91 EXT CAB	F	AP.03690		
	R			
92-99	F	AP.03690		
	R			
<b>C2500 SERIES (3/4 TON) PICKUP 2WD</b>				
90-96 W/ 11" REAR DRUM	F	AP.03690		
	R			
<b>DENALI (SEE YUKON)</b>				
<b>ENVOY</b>				
98-01	F		RP.07260.1	
	R		RP.07290.1	
02-05	F		RP.08820.1	
	R		RP.08830.1	
06-07	F		RP.11690.1	
	R		RP.08830.1	
<b>JIMMY MIDSIZE SUV (2WD)</b>				
89-97	F	AP.01540		
	R			
98-02	F		RP.07260.1	
	R		RP.07290.1	
<b>JIMMY MIDSIZE SUV (4WD)</b>				
89-97 W/ REAR DRUM	F	AP.01540		
	R			
97-02 W/ REAR DISC	F		RP.07260.1	

# BRAKE PAD

AXXIS PAD CERAMIC PAD

MAKE/MODEL	AXLE	ULTIMATE	H2	NOTES
YEAR	F/R	PART #	PART #	
	R		RP.07290.1	
<b>K1500 SERIES (1/2 TON) PICKUP 4WD</b>				
92-99	F	AP.03690		
	R			
<b>K2500 SERIES (3/4 TON) PICKUP 4WD</b>				
90-98 11" REAR DRUM BRAKE (7200 LBS. GVW)	F	AP.03690		
	R			
<b>SAFARI VAN</b>				
90-02 2WD	F	AP.00520		
	R			
90-02 4WD	F	AP.03690		
	R			
03-05	F		RP.07850.1	
	R		RP.07920.1	
<b>SAVANA 1500 (1/2 TON) VAN</b>				
96-02	F	AP.03690		
	R			
03-07	F		RP.07850.1	
	R		RP.09741.1	
<b>SAVANA 2500 (3/4 TON) VAN</b>				
96-02 6 LUG (7300 LBS. GVW)	F	AP.03690		
	R			
03-05 7300 LBS. GVW	F		RP.07850.1	
	R		RP.09740.1	
03-05 8500 LBS. GVW PANEL 8600 LBS. GVW PASS	F		RP.07840.1	
	R		RP.09740.1	
06-07	F		RP.07840.1	
	R		RP.09740.1	
<b>SAVANA 3500 (1 TON) VAN</b>				
03-07 SRW	F		RP.07840.1	
	R		RP.09740.1	
03-07 DRW	F		RP.07840.1	
	R			
<b>SIERRA 1500 (1/2 TON) 2WD</b>				
99-00	F		RP.07850.1	
	R		RP.07920.1	
01 2 DR	F		RP.07850.1	
	R		RP.07920.1	
01 4 DR (HD)	F		RP.07840.1	
	R		RP.07850.1	
02 REG CAB, 2 WHEEL STEERING	F		RP.07850.1	
	R		RP.07920.1	
02 EXT CAB, 4 WHEEL STEERING	F		RP.07850.1	
	R		RP.08340.1	
02 4 DR (HD)	F		RP.07840.1	
	R		RP.07850.1	
03 REG CAB	F		RP.07850.1	
	R		RP.07920.1	
03 EXT CAB, 2 WHEEL STEERING	F		RP.07850.1	
	R		RP.07920.1	
03 EXT CAB, 4 WHEEL STEERING 330MM REAR DISC	F		RP.07850.1	
	R		RP.08340.1	
03 EXT CAB, 4 WHEEL STEERING 325MM REAR DISC	F		RP.07850.1	
	R		RP.07920.1	
03 4 DR (HD), 2 WHEEL STEERING	F		RP.07840.1	
	R		RP.07850.1	
03 4 DR (HD), 4 WHEEL STEERING	F		RP.07840.1	
	R		RP.08340.1	
04 REG CAB	F		RP.07850.1	
	R		RP.07920.1	
04 CREW CAB	F		RP.07850.1	
	R		RP.08340.1	
04 EXT CAB, 2 WHEEL STEERING EXC HYBRID ELECTRIC	F		RP.07850.1	
	R		RP.07920.1	
04 EXT CAB, 4 WHEEL STEERING EXC HYBRID ELECTRIC	F		RP.07850.1	
	R		RP.08340.1	
04 EXT CAB, HYBRID ELECTRIC	F		RP.07850.1	
	R		RP.07920.1	



# BRAKE PAD

AXXIS PAD CERAMIC PAD

MAKE/MODEL		AXLE	ULTIMATE	H2	NOTES
YEAR		F/R	PART #	PART #	
04	EXT CAB (HD)	F		RP.07840.1	
		R		RP.07850.1	
05	REG CAB, EXT CAB, CREW CAB (EXC HD) W/ REAR DRUM	F		RP.10920.1	
		R			
05	CREW CAB (HD) W/O QUADRASTEER	F		RP.07840.1	
		R		RP.07850.1	
05	CREW CAB (4 DR), HD, 2 WHEEL STEERING W/ QUADRASTEER	F		RP.07840.1	
		R		RP.08340.1	
05	EXT CAB, HYBRID ELECTRIC	F		RP.07850.1	
		R		RP.07920.1	
06	REG CAB, EXT CAB, CREW CAB (EXC HD) W/ REAR DRUM	F		RP.10920.1	
		R			
06	REG CAB, EXT CAB, ELECTRIC HYBRID (EXC HD) W/ REAR DISC	F		RP.07850.1	
		R		RP.07920.1	
06	CREW CAB (HD)	F		RP.07840.1	
		R		RP.07850.1	
06	EXT CAB (SS-6.0L V8)	F		RP.07850.1	
		R		RP.08340.1	
07	W/ REAR DRUM	F		RP.10920.1	
		R			
07	W/ REAR DISC	F		RP.10920.1	
		R		RP.11940.1	
<b>SIERRA 1500 (1/2 TON) 4WD</b>					
99-00		F		RP.07850.1	
		R		RP.07920.1	
01-02	REG CAB, 2 WHEEL STEERING	F		RP.07850.1	
		R		RP.07920.1	
01-02	EXT CAB, 4 WHEEL STEERING	F		RP.07850.1	
		R		RP.08340.1	
01-02	4 DR (HD)	F		RP.07840.1	
		R		RP.07850.1	
03	EXT CAB, REG CAB, 2 WHEEL STEERING	F		RP.07850.1	
		R		RP.07920.1	
03	EXT CAB, 4 WHEEL STEERING 330MM REAR DISC	F		RP.07850.1	
		R		RP.08340.1	
03	EXT CAB, 4 WHEEL STEERING 325MM REAR DISC	F		RP.07850.1	
		R		RP.07920.1	
03	4 DR (HD); 2 WHEEL STEERING	F		RP.07840.1	
		R		RP.07850.1	
03	4 DR (HD); 4 WHEEL STEERING	F		RP.07840.1	
		R		RP.07920.1	
04	REG CAB	F		RP.07850.1	
		R		RP.07920.1	
04	CREW CAB	F		RP.07850.1	
		R		RP.08340.1	
04	EXT CAB, 2 WHEEL STEERING EXC HYBRID ELECTRIC	F		RP.07850.1	
		R		RP.07920.1	
04	EXT CAB, 4 WHEEL STEERING EXC HYBRID ELECTRIC	F		RP.07850.1	
		R		RP.08340.1	
04	EXT CAB, HYBRID ELECTRIC	F		RP.07850.1	
		R		RP.07920.1	
04	EXT CAB (HD)	F		RP.07840.1	
		R		RP.07850.1	
04	EXT CAB (SS-6.0L V8)	F		RP.07850.1	
		R		RP.07920.1	
05	REG CAB, EXT CAB, CREW CAB (EXC HD) W/ REAR DRUM	F		RP.10920.1	
		R			
05	CREW CAB (HD) W/O QUADRASTEER	F		RP.07840.1	
		R		RP.07850.1	
05	CREW CAB (4 DR), HD, 2 WHEEL STEERING W/ QUADRASTEER	F		RP.07840.1	
		R		RP.08340.1	
05	EXT CAB, HYBRID ELECTRIC	F		RP.07850.1	
		R		RP.07920.1	
06	REG CAB, EXT CAB, CREW CAB (EXC HD) W/ REAR DRUM	F		RP.10920.1	
		R			
06	REG CAB, EXT CAB, ELECTRIC HYBRID (EXC HD) W/ REAR DISC	F		RP.07850.1	
		R		RP.07920.1	
06	CREW CAB (HD)	F		RP.07840.1	

# BRAKE PAD

AXXIS PAD CERAMIC PAD

MAKE/MODEL		AXLE	ULTIMATE	H2	NOTES
YEAR		F/R	PART #	PART #	
06	EXT CAB (SS-6.0L V8)	R		RP.07850.1	
		F		RP.07850.1	
		R		RP.08340.1	
07	W/ REAR DRUM	F		RP.10920.1	
		R			
07	W/ REAR DISC	F		RP.10920.1	
		R		RP.11940.1	
<b>SIERRA 2500 (3/4 TON) 2WD &amp; 4WD</b>					
99-07		F		RP.07840.1	
		R		RP.07850.1	
<b>SIERRA 3500 (1 TON) 2WD</b>					
01-05		F		RP.07840.1	
		R		RP.09090.1	
06-07	SRW	F		RP.07840.1	
		R		RP.07850.1	
06-07	DRW	F		RP.07840.1	
		R		RP.09090.1	
<b>SIERRA 3500 (1 TON) 4WD</b>					
01-03		F		RP.07840.1	
		R		RP.09090.1	
04-07	SRW	F		RP.07840.1	
		R		RP.07850.1	
04-07	DRW	F		RP.07840.1	
		R		RP.09090.1	
<b>SONOMA PICKUP 2WD</b>					
91-03		F	AP.01540		
		R			
04		F		RP.07260.1	
		R		RP.07290.1	
<b>SONOMA PICKUP 4WD</b>					
91-97		F	AP.01540		
		R			
98-04		F		RP.07260.1	
		R		RP.07290.1	
<b>SUBURBAN 1500 (1/2 TON) (2WD &amp; 4WD)</b>					
81-91		F	AP.00520		
		R			
92-00	11" REAR DRUM BRAKE (5 LUG)	F	AP.03690		
		R			
<b>YUKON, DENALI 2WD (EXC XL)</b>					
95-00	EXC POLICE & PERFORMANCE PKG W/ REAR DRUM	F	AP.03690		
		R			
00-01	W/ REAR DISC	F		RP.07850.1	
		R		RP.08340.1	
02	CLASSIC STYLE	F		RP.07850.1	
		R		RP.08340.1	
02	NEW STYLE	F		RP.07850.1	
		R		RP.09741.1	
03-06		F		RP.07850.1	
		R		RP.09741.1	
07		F		RP.10920.1	
		R		RP.11940.1	
<b>YUKON, DENALI 4WD (EXC XL)</b>					
92-00	11" REAR DRUM BRAKE	F	AP.03690		
		R			
00-02	W/ LIMITED SLIP AXLE	F		RP.07850.1	
		R		RP.08340.1	
00-02	W/O LIMITED SLIP AXLE	F		RP.07850.1	
		R		RP.07920.1	
03-06		F		RP.07850.1	
		R		RP.08340.1	
07		F		RP.10920.1	
		R		RP.11940.1	
<b>YUKON, DENALI XL (1/2 TON)</b>					
00-02	W/ LIMITED SLIP AXLE	F		RP.07850.1	
		R		RP.08340.1	
00-02	W/O LIMITED SLIP AXLE	F		RP.07850.1	
		R		RP.07920.1	

# BRAKE PAD

AXXIS PAD CERAMIC PAD

MAKE/MODEL		AXLE	ULTIMATE	H2	NOTES
YEAR		F/R	PART #	PART #	
03-06	2WD	F		RP.07850.1	
		R		RP.09741.1	
03-06	4WD	F		RP.07850.1	
		R		RP.08340.1	
07		F		RP.10920.1	
		R		RP.11940.1	
<b>YUKON, DENALI XL (3/4 TON)</b>					
00-02		F		RP.07840.1	
		R		RP.07850.1	
03-05	2 WHEEL STEERING	F		RP.07840.1	
		R		RP.07850.1	
03-05	4 WHEEL STEERING	F		RP.07840.1	
		R		RP.07920.1	
06-07		F		RP.07840.1	
		R		RP.07850.1	
<b>HONDA</b>					
<b>ACCORD COUPE</b>					
90-92		F	AP.04960	RP.04960.1	
		R	AP.05370	RP.05370.1	
93-97		F	AP.04650	RP.04650.1	
		R	AP.05370	RP.05370.1	
98-02	4 CYL. (W/ REAR DRUM )	F	AP.07640	RP.07640.1	
		R			
98-02	4 CYL. (W/ REAR DISC )	F	AP.07640	RP.07640.1	
		R	AP.05370	RP.05370.1	
98-02	V6	F	AP.05030	RP.05030.1	
		R	AP.05370	RP.05370.1	
03-07	4 CYL. (EX W/ REAR DRUM)	F		RP.09140.1	
		R			
03-07	4 CYL. (EX W/ REAR DISC)	F		RP.09140.1	
		R	AP.05370	RP.05370.1	
03-07	V6-EX (6 SPEED M/T)	F	AP.07870	RP.07870.1	
		R	AP.05370	RP.05370.1	
03-07	V6-LX, EX (A/T)	F	AP.09590	RP.09590.1	
		R	AP.05370	RP.05370.1	
<b>ACCORD SEDAN</b>					
90-93	W/ REAR DRUM (AKEBONO FRONT CALIPER)	F	AP.04650	RP.04650.1	
		R			
90-93	W/ REAR DRUM (NISSIN FRONT CALIPER)	F	AP.04960	RP.04960.1	
		R			
90-93	W/ REAR DISC (AKEBONO FRONT CALIPER)	F	AP.04650	RP.04650.1	
		R	AP.05370	RP.05370.1	
90-93	W/ REAR DISC (NISSIN FRONT CALIPER)	F	AP.04960	RP.04960.1	
		R	AP.05370	RP.05370.1	
94	W/ REAR DRUM	F	AP.04650	RP.04650.1	
		R			
94	W/ REAR DISC	F	AP.04650	RP.04650.1	
		R	AP.05370	RP.05370.1	
95	4 CYL. (W/ REAR DRUM)	F	AP.04650	RP.04650.1	
		R			
95	4 CYL. (W/ REAR DISC)	F	AP.04650	RP.04650.1	
		R	AP.05370	RP.05370.1	
95	V6 (W/ REAR DRUM)	F	AP.05030	RP.05030.1	
		R			
95	V6 (W/ REAR DISC)	F	AP.05030	RP.05030.1	
		R	AP.05370	RP.05370.1	
96-97	4 CYL. (W/ REAR DRUM)	F	AP.04650	RP.04650.1	
		R			
96-97	4 CYL. (W/ REAR DISC)	F	AP.04650	RP.04650.1	
		R	AP.05370	RP.05370.1	
96-97	V6	F	AP.05030	RP.05030.1	
		R	AP.05370	RP.05370.1	
98-02	4 CYL. (W/ REAR DRUM )	F	AP.07640	RP.07640.1	
		R			
98-02	4 CYL. (W/ REAR DISC )	F	AP.07640	RP.07640.1	
		R	AP.05370	RP.05370.1	
98-02	V6	F	AP.05030	RP.05030.1	

# BRAKE PAD

AXXIS PAD CERAMIC PAD

MAKE/MODEL		AXLE	ULTIMATE	H2	NOTES
YEAR		F/R	PART #	PART #	
		R	AP.05370	RP.05370.1	
03-04	4 CYL. (EX W/ REAR DRUM)	F		RP.09140.1	
		R			
03-04	4 CYL. (EX W/ REAR DISC)	F		RP.09140.1	
		R	AP.05370	RP.05370.1	
03-04	V6	F	AP.09590	RP.09590.1	
		R	AP.05370	RP.05370.1	
05	4 CYL. (EX W/ REAR DRUM)	F		RP.09140.1	
		R			
05	4 CYL. (EX W/ REAR DISC)	F		RP.09140.1	
		R	AP.05370	RP.05370.1	
05	V6 (EXC HYBRID)	F	AP.09590	RP.09590.1	
		R	AP.05370	RP.05370.1	
05	V6 (HYBRID)	F		RP.09140.1	
		R	AP.05370	RP.05370.1	
06-07	4 CYL. (EX W/ REAR DRUM)	F		RP.09140.1	
		R			
06-07	4 CYL. (EX W/ REAR DISC)	F		RP.09140.1	
		R	AP.05370	RP.05370.1	
06-07	V6 (EXC HYBRID)	F	AP.09590	RP.09590.1	
		R	AP.05370	RP.05370.1	
06-07	V6 (HYBRID)	F	AP.07870	RP.07870.1	
		R	AP.05370	RP.05370.1	
<b>CIVIC COUPE</b>					
93-95	DX 1500	F	AP.02730	RP.02730.1	
		R			
93-95	EX 1600 (W/O ABS) REAR DRUM	F	AP.06210	RP.06210.1	
		R			
93-95	EX 1600 (W/ ABS) REAR DISC	F	AP.06170	RP.06170.1	
		R	AP.03740	RP.03740.1	
96-98	DX, HX	F	AP.02730	RP.02730.1	
		R			
96-98	EX	F	AP.07640	RP.07640.1	
		R			
99-00	DX, HX	F	AP.02730	RP.02730.1	
		R			
99-00	EX	F	AP.07640	RP.07640.1	
		R			
99-00	Si	F	AP.07640	RP.07640.1	
		R	AP.03740	RP.03740.1	
01-05	ALL MODEL	F	AP.07640	RP.07640.1	
		R			
06-07	DX, LX	F	AP.07640	RP.07640.1	
		R			
06-07	EX	F	AP.07640	RP.07640.1	
		R	AP.05370	RP.05370.1	
06-07	Si (2.0L)	F	AP.08290	RP.08290.1	
		R	AP.05370	RP.05370.1	
<b>CIVIC HATCHBACK</b>					
90-91		F	AP.02730	RP.02730.1	
		R			
92-93	1500 CX, DX, VX	F	AP.02730	RP.02730.1	
		R			
92-93	1600 Si	F	AP.02730	RP.02730.1	
		R	AP.03740	RP.03740.1	
94-95	1500 CX, DX, VX	F	AP.02730	RP.02730.1	
		R			
94-95	1600 Si (W/O ABS)	F	AP.02730	RP.02730.1	
		R	AP.03740	RP.03740.1	
94-95	1600 Si (W/ ABS)	F	AP.06170	RP.06170.1	
		R	AP.03740	RP.03740.1	
96-00		F	AP.02730	RP.02730.1	
		R			
02-03	Si	F	AP.07640	RP.07640.1	
		R	AP.05370	RP.05370.1	
04-05	Si	F	AP.06210	RP.06210.1	
		R	AP.05370	RP.05370.1	
<b>CIVIC SEDAN</b>					

# BRAKE PAD

AXXIS PAD CERAMIC PAD

MAKE/MODEL		AXLE	ULTIMATE	H2	NOTES
YEAR		F/R	PART #	PART #	
90-91	1500 DX, LX	F R	AP.02730	RP.02730.1	
90-91	EX 1600	F R	AP.04090	RP.04090.1	
92-93	DX, LX	F R	AP.02730	RP.02730.1	
92-93	EX	F R	AP.04090 AP.03740	RP.04090.1 RP.03740.1	
94-95	DX, LX	F R	AP.02730	RP.02730.1	
94-95	EX, LX (W/ ABS)	F R	AP.06170 AP.03740	RP.06170.1 RP.03740.1	
96	DX, LX	F R	AP.02730	RP.02730.1	
96	EX, LX (W/ ABS, A/T)	F R	AP.07640	RP.07640.1	
97-00	DX, LX	F R	AP.02730	RP.02730.1	
97-00	EX	F R	AP.07640	RP.07640.1	
97-00	GX	F R	AP.02730	RP.02730.1	
01-05	DX, EX, GX, LX	F R	AP.07640	RP.07640.1	
06-07	DX, LX	F R	AP.07640	RP.07640.1	
06-07	EX	F R	AP.07640 AP.05370	RP.07640.1 RP.05370.1	
06-07	GX	F R	AP.09590	RP.09590.1	
07	Si (2.0L)	F R	AP.08290 AP.05370	RP.08290.1 RP.05370.1	
<b>CIVIC DEL SOL</b>					
93-97	S	F R	AP.02730	RP.02730.1	
93-97	Si (W/O ABS)	F R	AP.02730 AP.03740	RP.02730.1 RP.03740.1	
93-97	V-TEC (W/ ABS)	F R	AP.06210 AP.03740	RP.06210.1 RP.03740.1	
<b>CR-V</b>					
97-01	EX, LX, SE	F R	AP.05030	RP.05030.1	
02-04		F R	AP.05360	RP.09140.1 RP.05360.1	
05-06		F R		RP.09140.1	
07		F R		RP.10890.1	
<b>CRX</b>					
90-91	DX 1.5L	F R	AP.02730	RP.02730.1	
90-91	HF 1.5L	F R	AP.02560	RP.02560.1	
90-91	Si 1.6L	F R	AP.03730 AP.03740	RP.03730.1 RP.03740.1	
<b>ELEMENT</b>					
03-07		F R	AP.05360	RP.09140.1 RP.05360.1	
<b>FIT</b>					
07		F R	AP.06210	RP.06210.1	
<b>ODYSSEY</b>					
95-98		F R	AP.05030 AP.05360	RP.05030.1 RP.05360.1	
05-07		F R		RP.10890.1	
<b>PASSPORT</b>					
94-11/95		F	AP.03630		

# BRAKE PAD

AXXIS PAD CERAMIC PAD

MAKE/MODEL	AXLE	ULTIMATE	H2	NOTES
YEAR	F/R	PART #	PART #	
	R			
12/95-01 W/ REAR DRUM	F	AP.05790		
	R			
12/95-01 W/ REAR DISC	F	AP.05790		
	R	AP.05800		
02 4WD	F			
	R	AP.05800		
<b>PILOT</b>				
03-07	F		RP.09140.1	
	R			
<b>PRELUDE</b>				
90 S	F	AP.03730	RP.03730.1	
	R	AP.03740	RP.03740.1	
90-91 Si	F	AP.04090	RP.04090.1	
	R	AP.03740	RP.03740.1	
92-96 S, SE, Si	F	AP.05680	RP.05680.1	
	R	AP.05370	RP.05370.1	
92-96 V-TEC	F	AP.05030	RP.05030.1	
	R	AP.05370	RP.05370.1	
97-01 BASE, SH	F	AP.05030	RP.05030.1	
	R	AP.05370	RP.05370.1	
<b>S2000</b>				
00-07	F	AP.08290	RP.08290.1	
	R	AP.05370	RP.05370.1	
<b>HUMMER</b>				
<b>H2</b>				
03-07	F		RP.07840.1	
	R		RP.07850.1	
<b>HYUNDAI</b>				
<b>ELANTRA</b>				
92-01 W/ REAR DRUM	F	AP.07000	RP.07000.1	
	R			
92-01 W/ REAR DISC	F	AP.07000	RP.07000.1	
	R	AP.03230		
02-8/05 W/ REAR DISC	F			
	R	AP.03230		
9/05-06 W/ REAR DRUM	F	AP.07000	RP.07000.1	
	R			
9/05-06 W/ REAR DISC	F	AP.07000	RP.07000.1	
	R	AP.03230		
<b>SONATA</b>				
89-3/03	F	AP.07000	RP.07000.1	
	R			
4/03-8/03 W/ ABS	F	AP.07000	RP.07000.1	
	R			
<b>TIBURON</b>				
97-01 W/ REAR DRUM	F	AP.07000	RP.07000.1	
	R			
97-01 W/ REAR DISC	F	AP.07000	RP.07000.1	
	R	AP.03230		
03-07	F			
	R	AP.03230		
<b>INFINITI</b>				
<b>FX35, FX45</b>				
03	F	AP.09690	RP.09690.1	
	R	AP.09050	RP.09050.1	
04-5/04	F		RP.09691.1	
	R	AP.09050	RP.09050.1	
5/04-11/05	F	AP.09690	RP.09690.1	
	R	AP.09050	RP.09050.1	
11/05-07	F	AP.08880	RP.08880.1	
	R	AP.09050	RP.09050.1	
<b>G20</b>				
91-97	F	AP.07000	RP.07000.1	
	R	AP.05400	RP.05400.1	

# BRAKE PAD

AXXIS PAD CERAMIC PAD

MAKE/MODEL		AXLE	ULTIMATE	H2	NOTES
YEAR		F/R	PART #	PART #	
99-11/00		F	AP.06530	RP.06530.1	
		R	AP.05400	RP.05400.1	
11/00-02		F	AP.06530	RP.06530.1	
		R	AP.09000		
<b>G35</b>					
02-04	BASE MODEL	F	AP.06530	RP.06530.1	
		R	AP.09050	RP.09050.1	
02-04	W/ BREMBO CALIPER	F	AP.09600	RP.09600.1	
		R	AP.09610	RP.09610.1	
05	2WD	F	AP.08880	RP.08880.1	
		R	AP.09050	RP.09050.1	
05	4WD	F	AP.06530	RP.06530.1	
		R	AP.09050	RP.09050.1	
06	2WD, 4WD	F	AP.08880	RP.08880.1	
		R	AP.09050	RP.09050.1	
07	ALL MODEL (EXC 2WD SPORT SEDAN)	F	AP.08880	RP.08880.1	
		R	AP.09050	RP.09050.1	
07	2WD SPORT SEDAN	F			
		R	AP.09050	RP.09050.1	
<b>I30, I35</b>					
95-99		F	AP.06530	RP.06530.1	
		R	AP.05400	RP.05400.1	
00-10/00		F	AP.06530	RP.06530.1	
		R	AP.05400	RP.05400.1	
11/00-01		F	AP.06530	RP.06530.1	
		R	AP.09000		
02-04		F	AP.08151	RP.08151.1	
		R	AP.09000		
<b>M35, M45</b>					
03-05		F	AP.08880	RP.08880.1	
		R			
06-07		F	AP.08880	RP.08880.1	
		R	AP.09050	RP.09050.1	
<b>Q45</b>					
90-2/94		F	AP.04860		
		R			
95	ACTIVE SUSPENSION	F	AP.04860		
		R			
97-01		F	AP.06910	RP.06910.1	
		R			
02-07		F	AP.08880	RP.08880.1	
		R			
<b>QX4, QX56</b>					
97-03		F	AP.06910	RP.06910.1	
		R			
04-3/05		F	AP.10150		
		R	AP.10410		
4/05-07		F			
		R	AP.10410		
<b>ISUZU</b>					
<b>ASCENDER</b>					
02-05		F		RP.08820.1	
		R		RP.08830.1	
<b>HOMBRE</b>					
96-97	2WD, 4WD	F	AP.01540		
		R			
98-00	2WD	F	AP.01540		
		R			
98-00	4WD	F		RP.07260.1	
		R		RP.07290.1	
<b>RODEO (EXC SPORT)</b>					
91-10/92		F	AP.03630		
		R			
11/92-11/95	W/ REAR DRUM	F	AP.03630		
		R			
11/92-11/95	W/ REAR DISC	F	AP.05790		
		R	AP.05800		

# BRAKE PAD

AXXIS PAD CERAMIC PAD

MAKE/MODEL	AXLE	ULTIMATE	H2	NOTES
YEAR	F/R	PART #	PART #	
12/95-6/01 W/ REAR DRUM	F R	AP.05790		
12/95-6/01 W/ REAR DISC	F R	AP.05790 AP.05800		
7/01-04 W/ REAR DISC	F R	AP.05800		
<b>RODEO SPORT</b>				
01-6/01 W/ REAR DRUM	F R	AP.05790		
01-6/01 W/ REAR DISC	F R	AP.05790 AP.05800		
7/01-03 W/ REAR DISC	F R	AP.05800		
<b>TROOPER</b>				
92-02	F R	AP.05790 AP.05800		
<b>VEHICROSS</b>				
99-01	F R	AP.05790 AP.05800		
<b>JAGUAR</b>				
<b>S TYPE</b>				
00-02	F R	AP.08050 AP.08060		
03-04	F R	AP.09330 AP.09440		
05	F R	AP.09440		
06-07	F R		RP.10950.1	
<b>S TYPE 'R'</b>				
06-07	F R		RP.10950.1	
<b>XJ 6-SOVERGN &amp; VANDEN PLAS</b>				
90-94	F R	AP.03941 AP.05170		
95-97	F R	AP.03941 AP.06880		
<b>XJ 8-VANDEN PLAS</b>				
98-03	F R	AP.03941		
04	F R	AP.09330 AP.09440		
05	F R	AP.08060		
06-07	F R		RP.10950.1	
<b>XJ 12</b>				
93-94	F R	AP.05170		
95-96	F R	AP.03941 AP.06880		
<b>XJ-R, XJR-S, XJ SPORT, XJ SUPER V8</b>				
93-94	F R	AP.01350 AP.05170		
95-97	F R	AP.01350 AP.06880		
98	F R	AP.03941		
99-01	F R	AP.03941		
06-07	F R		RP.10950.1	
<b>XJ-S, XJ-SC</b>				
1/87-93	F R	AP.01350 AP.00090		
94-95	F R	AP.01350 AP.05170		



# BRAKE PAD

AXXIS PAD CERAMIC PAD

MAKE/MODEL	AXLE	ULTIMATE	H2	NOTES
YEAR	F/R	PART #	PART #	
96	F R	AP.01350 AP.06880		
<b>XK 8</b>				
97-06	F R	AP.03941		
07	F R		RP.10950.1	
<b>JEEP</b>				
<b>CHEROKEE, SPORTWAGON</b>				
90-99	F R	AP.04770		
<b>COMANCHE</b>				
90-92 4WD	F R	AP.04770		
<b>COMPASS</b>				
07	F R	AP.08660	RP.08660.1	
<b>GRAND CHEROKEE</b>				
93-98	F R	AP.04770		
06-07 SRT-8	F R		RP.11490.1 RP.10530.1	
<b>PATRIOT</b>				
07	F R	AP.08660	RP.08660.1	
<b>WRANGLER</b>				
90-05	F R	AP.04770		
<b>LAND ROVER</b>				
<b>DEFENDER 90</b>				
94-97	F R	AP.06710 AP.05181		
<b>DEFENDER 110</b>				
93	F R	AP.06710		
<b>DISCOVERY</b>				
94-99	F R	AP.05201 AP.05181		
<b>DISCOVERY SERIES II</b>				
99-04	F R	AP.06760 AP.04930		
<b>RANGE ROVER</b>				
90-93	F R	AP.05200 AP.05180		
94-95 EXC 4.0 SE	F R	AP.05200 AP.05180		
94-95 4.0 SE	F R	AP.06760 AP.04930		
96-02 4.0 SE, 4.6 HSE	F R	AP.06760 AP.04930		
03-05 HSE	F R	AP.06810 AP.06830	RP.06810.1 RP.06830.1	
<b>LEXUS</b>				
<b>ES 300</b>				
92-96	F R	AP.04760 AP.03250	RP.03250.1	
97-99	F R	AP.07070 AP.03250	RP.07070.1 RP.03250.1	
00-01	F R	AP.07070 AP.08350	RP.07070.1 RP.08350.1	
<b>GS 300, GS 350, GS 400, GS 430, GS 450H</b>				
93-97	F R	AP.06190 AP.05720	RP.06190.1	
98-05	F R	AP.06190 AP.07710	RP.06190.1 RP.07710.1	

# BRAKE PAD

AXXIS PAD CERAMIC PAD

MAKE/MODEL		AXLE	ULTIMATE	H2	NOTES
YEAR		F/R	PART #	PART #	
06	GS 300	F	AP.09080		
		R		RP.11130.1	
06	GS 430	F		RP.11180.1	
		R		RP.11130.1	
07	GS 350, GS 430, GS 450H	F		RP.11180.1	
		R		RP.11130.1	
<b>GX 470</b>					
03-07		F	AP.09760	RP.09760.1	
		R	AP.06060	RP.06060.1	
<b>IS 250, IS 300, IS 350</b>					
00-05		F	AP.06190	RP.06190.1	
		R	AP.07710	RP.07710.1	
06-07	IS250	F			
		R		RP.11130.1	
06-07	IS350	F		RP.11180.1	
		R		RP.11130.1	
<b>LS 400, LS 430</b>					
89-92	LS 400	F	AP.04760		
		R	AP.04880		
01-06	LS 430	F	AP.08700		
		R			
<b>LX 450, LX 470</b>					
96-97	LX 450	F	AP.05020		
		R	AP.06060	RP.06060.1	
98-07	LX 470	F	AP.07720		
		R	AP.07730		
<b>RX 300, RX 330, RX 350, RX 400H</b>					
98-01	RX 300 (2WD, AWD)	F	AP.07070	RP.07070.1	
		R	AP.03250	RP.03250.1	
02-03	RX 300 (2WD, AWD)	F			
		R	AP.03250	RP.03250.1	
04-07	RX 330, 350, 400H	F	AP.10050		
		R			
<b>SC 300, SC 400, SC 430</b>					
92-98	SC 300	F	AP.04760		
		R	AP.05720		
92-98	SC 400	F			
		R	AP.05720		
99-00	SC 300, SC 400	F			
		R	AP.05720		
02-07	SC 430	F	AP.06190	RP.06190.1	
		R	AP.07710	RP.07710.1	
<b>LINCOLN</b>					
<b>BLACKWOOD</b>					
02		F		RP.06790.1	
		R		RP.07110.1	
<b>CONTINENTAL</b>					
95-02		F			
		R	AP.06100		
<b>LS</b>					
00-06		F	AP.08050		
		R	AP.08060		
<b>MARK LT</b>					
06-07		F		RP.10110.1	
		R		RP.10120.1	
<b>MK X</b>					
07		F		RP.11640.1	
		R		RP.11610.1	
<b>NAVIGATOR</b>					
97-3/02		F		RP.07020.1	
		R		RP.07110.1	
3/02-06		F		RP.09340.1	
		R		RP.09350.1	
07		F		RP.12780.1	
		R		RP.12790.1	
<b>ZEPHYR</b>					
07		F		RP.11640.1	

# BRAKE PAD

AXXIS PAD CERAMIC PAD

MAKE/MODEL	AXLE	ULTIMATE	H2	NOTES
YEAR	F/R	PART #	PART #	
	R		RP.11610.1	
<b>MAZDA</b>				
<b>MIATA MX-5</b>				
89-93	F	AP.05250	RP.05250.1	
	R	AP.04580	RP.04580.1	
94-00	F	AP.06350	RP.06350.1	
	R	AP.06360	RP.06360.1	
01-05 EXC SPORT SUSPENSION	F	AP.06350	RP.06350.1	
	R	AP.06360	RP.06360.1	
01-05 W/ SPORT SUSPENSION	F	AP.08900		
	R	AP.08910		
04-05 MAZDASPEED MX-5 TURBO	F	AP.08900		
	R	AP.08910		
<b>MX-3</b>				
92-95	F	AP.04730	RP.04730.1	
	R			
<b>MX-6</b>				
88-92 W/ REAR DRUM	F	AP.03990		
	R			
88-92 W/ REAR DISC	F	AP.03990		
	R			
93-97 W/ REAR DRUM	F	AP.06370	RP.06370.1	
	R			
93-97 W/ REAR DISC	F	AP.06370	RP.06370.1	
	R	AP.05840	RP.05840.1	
<b>PROTÉGÉ</b>				
90-94 DOHC	F	AP.04730	RP.04730.1	
	R	AP.04580	RP.04580.1	
90-94 SOHC	F	AP.04660		
	R			
95-98 DOHC	F	AP.04730	RP.04730.1	
	R	AP.06360	RP.06360.1	
95-98 SOHC	F	AP.04660		
	R			
99-00 1.8L ENG	F	AP.06370	RP.06370.1	
	R			
01 2.0L ENG LX (W/ REAR DRUM)	F	AP.06370	RP.06370.1	
	R			
01 2.0L ENG ES, MP3 (W/ REAR DISC)	F	AP.06370	RP.06370.1	
	R			
02-03 DX, LX (W/ REAR DRUM)	F	AP.06370	RP.06370.1	
	R			
02-03 ES (W/ REAR DISC)	F	AP.06370	RP.06370.1	
	R			
02-03 PROTÉGÉ 5	F	AP.06370	RP.06370.1	
	R			
03 PROTÉGÉ MAZDASPEED	F	AP.07550	RP.07550.1	
	R	AP.03320	RP.03320.1	
<b>RX7</b>				
86-88 4 LUG	F	AP.01310		
	R	AP.03320	RP.03320.1	
86-88 5 LUG (TURBO/NON TURBO)	F	AP.03310	RP.03310.1	
	R	AP.03320	RP.03320.1	
89-92 W/ SOLID REAR DISC	F	AP.01310		
	R	AP.03320	RP.03320.1	
89-92 W/ VENTED REAR DISC	F	AP.03310	RP.03310.1	
	R	AP.03320	RP.03320.1	
93-95	F	AP.03310	RP.03310.1	
	R	AP.03320	RP.03320.1	
<b>RX8</b>				
04-07	F	AP.10090		
	R	AP.10080		
<b>3</b>				
04-05	F	AP.10440	RP.10440.1	
	R	AP.09730	RP.09730.1	
06-07 EXC MAZDASPEED 3 (TURBO)	F	AP.10440	RP.10440.1	
	R		RP.10950.1	

# BRAKE PAD

AXXIS PAD CERAMIC PAD

MAKE/MODEL		AXLE	ULTIMATE	H2	NOTES
YEAR		F/R	PART #	PART #	
07	MAZDASPEED 3 (TURBO)	F R		RP.09152.1 RP.10950.1	
<b>5</b>					
06-07		F R	AP.10440 AP.09730	RP.10440.1 RP.09730.1	
<b>6</b>					
03-05		F R		RP.09570.1 RP.03320.1	
06-07	EXC MAZDASPEED 6	F R		RP.11640.1 RP.11610.1	
06-07	MAZDASPEED 6	F R		RP.11860.1 RP.11610.1	
<b>626</b>					
89-92	W/ REAR DRUM	F R	AP.03990		
89-92	W/ REAR DISC	F R	AP.03990		
93-97	W/ REAR DRUM	F R	AP.06370	RP.06370.1	
93-97	W/ REAR DISC	F R	AP.06370 AP.05840	RP.06370.1 RP.05840.1	
98-02	2.0L ENG	F R	AP.06370	RP.06370.1	
98-02	2.5L ENG	F R	AP.07550 AP.05840	RP.07550.1 RP.05840.1	
<b>929, S</b>					
88-91		F R	AP.03890		
<b>MERCEDES-BENZ</b>					
<b>C32 AMG (W203)</b>					
02-04		F R	AP.08470 AP.06030		
<b>C36 AMG (W202)</b>					
95		F R	AP.05610 AP.04950		
96-97		F R	AP.05610 AP.06030		
<b>C43 AMG (W202)</b>					
99-00		F R	AP.06820 AP.06030		
<b>C55 AMG (W203)</b>					
05-07		F R	AP.08470 AP.06030		
<b>C230 (W202, W203)</b>					
99-00	1 PAD PIN REAR CALIPER	F R	AP.07100 AP.07790		
99-00	2 PAD PIN REAR CALIPER	F R	AP.07100 AP.04950		
03	EXC SPORT PKG	F R		AP.07790	
04		F R	AP.08470 AP.08760		
05-07		F R		AP.08760	
<b>C240 SEDAN, WAGON (W203)</b>					
01-02		F R		AP.07790	
03-05	SEDAN (EXC 4-MATIC AWD)	F R		AP.07790	
03-05	SEDAN (4-MATIC AWD)	F R		AP.08760	
03-05	WAGON	F R		AP.08760	
<b>C280 (W202)</b>					
96-00	1 PAD PIN REAR CALIPER	F R	AP.07100 AP.07790		
96-00	2 PAD PIN REAR CALIPER	F	AP.07100		

# BRAKE PAD

AXXIS PAD CERAMIC PAD

MAKE/MODEL	AXLE	ULTIMATE	H2	NOTES
YEAR	F/R	PART #	PART #	
06-07	R	AP.04950		
	F			
	R	AP.08760		
<b>C320, C350 SEDAN, WAGON (W203)</b>				
03-07	F			
	R	AP.08760		
<b>CL55 (W215)</b>				
01-02	F	AP.08470		
	R	AP.08480		
<b>CL500 (W140, W215); CL550 (W216)</b>				
98-99	F	AP.05770		
	R	AP.06030		
00-03	F	AP.08470		
	R	AP.08480		
04-06	F	AP.08470		
	R	AP.09860		
07 CL550	F			
	R	AP.09860		
<b>CL600 (W140, W215)</b>				
98-99	F	AP.05770		
	R	AP.06030		
01-02	F	AP.08470		
	R	AP.08480		
03-06	F	AP.08470		
	R			
<b>CLK55 AMG (W208, W209)</b>				
01-02	F	AP.06820		
	R	AP.06030		
03-04	F	AP.08470		
	R	AP.06030		
<b>CLK320, CLK350 (W208, W209)</b>				
98-99	F	AP.07400		
	R	AP.06030		
00-02	F	AP.07400		
	R	AP.08760		
03-07	F			
	R	AP.08760		
<b>CLK430 (W208), CLK500, CLK550 (W209)</b>				
99	F	AP.07400		
	R	AP.06030		
00-02	F	AP.07400		
	R	AP.08760		
03 CLK430	F	AP.07400		
	R	AP.08760		
03 CLK500	F	AP.08470		
	R	AP.06030		
04-07	F	AP.08470		
	R	AP.06030		
<b>CLS500, CLS550 (W219)</b>				
05-07	F	AP.08470		
	R	AP.09860		
<b>E55 AMG (W210, W211)</b>				
99-02	F	AP.06820		
	R	AP.06030		
06	F	AP.08470		
	R			
<b>E300 DIESEL, TURBODIESEL (W124, W210)</b>				
94-95	F	AP.04230		
	R	AP.03350		
96-97 1 PAD PIN REAR CALIPER	F	AP.07100		
	R	AP.07790		
96-97 2 PAD PIN REAR CALIPER	F	AP.07100		
	R	AP.04950		
98-00 1 PAD PIN REAR CALIPER	F	AP.07400		
	R	AP.08760		
98-00 2 PAD PIN REAR CALIPER	F	AP.07400		
	R	AP.06030		
<b>E320, E350 COUPE, CABRIOLET, SEDAN (W124, W210, W211)</b>				

# BRAKE PAD

AXXIS PAD CERAMIC PAD

MAKE/MODEL		AXLE	ULTIMATE	H2	NOTES
YEAR		F/R	PART #	PART #	
94-95		F	AP.05611		
		R	AP.04950		
96-02	EXC 4-MATIC (1 PAD PIN REAR CALIPER)	F	AP.07400		
		R	AP.08760		
96-02	EXC 4-MATIC (2 PAD PIN REAR CALIPER)	F	AP.07400		
		R	AP.06030		
03-05	EXC 4-MATIC AWD	F	AP.09870		
		R	AP.09860		
06	E320 CDI	F	AP.09870		
		R	AP.09860		
06	E350 (EXC 4-MATIC)	F	AP.08470		
		R	AP.09860		
06	E350 (4-MATIC)	F			
		R	AP.09860		
07	EXC SPORT SEDAN	F	AP.09870		
	EXC 4-MATIC	R	AP.09860		
07	SPORT SEDAN	F	AP.08470		
	EXC 4-MATIC	R	AP.09860		
07	4-MATIC	F			
		R	AP.09860		
<b>E320, E350 WAGON (W124, W210, W211)</b>					
94-95		F	AP.05611		
		R	AP.06030		
98-03		F	AP.07400		
		R	AP.06030		
04-05	E320 (EXC 4-MATIC)	F	AP.09870		
		R	AP.09860		
04-05	E320 (4-MATIC)	F			
		R	AP.09860		
06	E350 (EXC 4-MATIC)	F	AP.08470		
		R	AP.09860		
06	E350 (4-MATIC)	F			
		R	AP.09860		
07	4-MATIC AWD	F			
		R	AP.09860		
<b>E420, E430 (W124, W210)</b>					
94-95		F	AP.05611		
		R	AP.04950		
97-99	1 PAD PIN REAR CALIPER	F	AP.07400		
		R	AP.08760		
97-99	2 PAD PIN REAR CALIPER	F	AP.07400		
		R	AP.06030		
00	1 PAD PIN REAR CALIPER	F	AP.07400		
		R	AP.08760		
00	2 PAD PIN REAR CALIPER	F	AP.07400		
		R	AP.06030		
00	E430 (4-MATIC AWD)	F	AP.06820		
		R	AP.06030		
01-02	E430 (EXC 4-MATIC AWD)	F	AP.07400		
		R	AP.08760		
01-02	E430 (4-MATIC AWD)	F	AP.06820		
		R	AP.06030		
<b>E500, E550 (W124, W211)</b>					
94		F	AP.05610		
		R	AP.04950		
03		F	AP.08470		
		R	AP.09860		
04-05	EXC 4-MATIC AWD	F	AP.08470		
		R	AP.09860		
04-05	4-MATIC AWD	F	AP.06820		
		R	AP.09860		
06-07	EXC 4-MATIC AWD	F	AP.08470		
		R	AP.09860		
06-07	4-MATIC AWD	F			
		R	AP.09860		
<b>ML55 AMG (W163)</b>					
00-03		F	AP.08470		
		R	AP.08740		

# BRAKE PAD

AXXIS PAD CERAMIC PAD

MAKE/MODEL	AXLE	ULTIMATE	H2	NOTES
YEAR	F/R	PART #	PART #	
<b>ML320, ML350 (W163, W164)</b>				
98-05	F	AP.07600		
	R	AP.08750		
<b>ML430, ML500 (W163, W164)</b>				
98-99	F	AP.07600		
	R	AP.08750		
00-05	F	AP.08470		
	R	AP.08740		
<b>S55 AMG (W220)</b>				
01-02	F	AP.08470		
	R	AP.08480		
<b>S320 (W140), S350 (W220, W221), S350 TURBODIESEL (W140)</b>				
94-99 ATE FRONT CALIPER	F			
	R	AP.06030		
94-99 GIRLING FRONT CALIPER	F	AP.05770		
	R	AP.06030		
06	F	AP.08470		
	R	AP.09860		
07	F			
	R	AP.09860		
<b>S420, S430 (W140, W220)</b>				
94-99	F	AP.05770		
	R	AP.06030		
00-9/2/02	F	AP.08470		
	R	AP.08480		
9/3/02-03 EXC 4-MATIC AWD	F	AP.08470		
	R	AP.08480		
9/3/02-03 4-MATIC AWD	F	AP.06820		
	R	AP.09860		
04-06 EXC 4-MATIC AWD	F	AP.08470		
	R	AP.09860		
04-06 4-MATIC AWD	F	AP.06820		
	R	AP.09860		
<b>S500 (W140, W220), S550 (W221)</b>				
94-99	F	AP.05770		
	R	AP.06030		
00-9/2/02	F	AP.08470		
	R	AP.08480		
9/3/02-06 EXC 4-MATIC AWD	F	AP.08470		
	R	AP.08480		
9/3/02-06 4-MATIC AWD	F	AP.06820		
	R	AP.09860		
07 S550	F			
	R	AP.09860		
<b>S600 (W140, W220, W221)</b>				
94-99	F	AP.05770		
	R	AP.06030		
01-03 W/ STD FRONT BRAKE	F	AP.08470		
	R	AP.08480		
01-03 UPGRADED FRONT BRAKE	F			
	R	AP.08480		
04-06 W/ STD FRONT BRAKE (W220)	F	AP.08470		
	R			
07 W221	F			
	R	AP.09860		
<b>SL320, SL500, SL550 (R129, R230)</b>				
94-95	F	AP.05610		
	R	AP.04950		
96-98	F	AP.05610		
	R	AP.06030		
99-02	F	AP.08470		
	R	AP.06030		
03-07	F	AP.08470		
	R	AP.09860		
<b>SL600 (R129, R230)</b>				
94-02	F	AP.08470		
	R	AP.06030		
<b>SLK32 AMG (R170)</b>				

# BRAKE PAD

AXXIS PAD CERAMIC PAD

MAKE/MODEL	AXLE	ULTIMATE	H2	NOTES
YEAR	F/R	PART #	PART #	
01-04	F R	AP.06820 AP.06030		
<b>SLK230, SLK280, SLK320, SLK350 (R170, R171)</b>				
98-00 1 PAD REAR CALIPER	F R	AP.07100 AP.07790		
98-00 2 PAD REAR CALIPER	F R	AP.07100 AP.04950		
01	F R	AP.07100 AP.07790		
02-04 SLK230	F R	AP.07100 AP.07790		
02-04 SLK320	F R	AP.07400 AP.07790		
05-2/06 SLK350	F R	AP.08470 AP.08760		
3/06-07 SLK350	F R	AP.08760		
07 SLK280	F R	AP.07790		
07 SLK350	F R	AP.08760		
<b>MERCURY</b>				
<b>COUGAR</b>				
93-97 EXC SPORT PACAKGE	F R		RP.06000.1	
<b>MILAN</b>				
07	F R		RP.11640.1 RP.11610.1	
<b>MOUNTAINEER</b>				
97-01	F R	AP.06520 AP.06670		
<b>MINI</b>				
<b>COOPER, COOPER S</b>				
02-07 EXC JOHN COOPER WORKS	F R	AP.09390 AP.10600		
06-07 JOHN COOPER WORKS	F R	AP.10600		
<b>MITSUBISHI</b>				
<b>DIAMANTE</b>				
92-96 SEDAN	F R	AP.05300 AP.03830	RP.05300.1 RP.03830.1	
92-96 WAGON	F R	AP.05300 AP.05320	RP.05300.1 RP.05320.1	
97-04	F R	AP.05300 AP.07240	RP.05300.1	
<b>ECLIPSE (EXC TURBO)</b>				
4/89-93	F R	AP.04840 AP.03290	RP.04840.1 RP.03290.1	
94-99 W/ REAR DRUM	F R	AP.04840	RP.04840.1	
94-99 W/ REAR DISC	F R	AP.04840 AP.03830	RP.04840.1 RP.03830.1	
00 4 CYL.	F R	AP.04840	RP.04840.1	
00 V6	F R	AP.05300 AP.03830	RP.05300.1 RP.03830.1	
01 4 CYL.	F R	AP.04840	RP.04840.1	
01 V6	F R	AP.08660 AP.03830	RP.08660.1 RP.03830.1	
02-05 4 CYL.	F R	AP.08660	RP.08660.1	
02-05 V6	F R	AP.08660 AP.03830	RP.08660.1 RP.03830.1	
06-07 4 CYL.	F	AP.08660	RP.08660.1	



# BRAKE PAD

AXXIS PAD CERAMIC PAD

MAKE/MODEL	AXLE	ULTIMATE	H2	NOTES
YEAR	F/R	PART #	PART #	
06-07 6 CYL.	R	AP.03830	RP.03830.1	
	F	AP.08660	RP.08660.1	
	R	AP.05320	RP.05320.1	
<b>ECLIPSE TURBO (2WD)</b>				
4/89-93	F	AP.04840	RP.04840.1	
	R	AP.03290	RP.03290.1	
94-99	F	AP.04840	RP.04840.1	
	R	AP.03830	RP.03830.1	
<b>ECLIPSE TURBO (4WD)</b>				
4/89-5/92	F	AP.04840	RP.04840.1	
	R	AP.03290	RP.03290.1	
6/92-93	F	AP.05300	RP.05300.1	
	R	AP.03290	RP.03290.1	
94-10/94	F	AP.05300	RP.05300.1	
	R	AP.05320	RP.05320.1	
11/94-99	F	AP.05300	RP.05300.1	
	R	AP.03830	RP.03830.1	
<b>GALANT (EXC SIGMA)</b>				
11/89-5/90 W/ REAR DRUM	F	AP.04840	RP.04840.1	
	R			
11/89-5/90 W/ REAR DISC	F	AP.04840	RP.04840.1	
	R	AP.03290	RP.03290.1	
11/89-5/90 AWD	F	AP.04840	RP.04840.1	
	R	AP.03290	RP.03290.1	
6/90-5/92 W/ REAR DRUM	F	AP.04840	RP.04840.1	
	R			
6/90-5/92 W/ REAR DISC	F	AP.04840	RP.04840.1	
	R	AP.03290	RP.03290.1	
6/90-5/92 AWD (EXC TURBO)	F	AP.04840	RP.04840.1	
	R	AP.03290	RP.03290.1	
6/90-5/92 AWD TURBO	F	AP.05300	RP.05300.1	
	R	AP.03290	RP.03290.1	
6/92-1/93 W/ REAR DRUM	F	AP.04840	RP.04840.1	
	R			
6/92-1/93 W/ REAR DISC	F	AP.04840	RP.04840.1	
	R	AP.03290	RP.03290.1	
6/92-1/93 AWD TURBO	F	AP.05300	RP.05300.1	
	R	AP.03290	RP.03290.1	
2/93-1/98 W/ REAR DRUM	F	AP.04840	RP.04840.1	
	R			
2/93-1/98 W/ REAR DISC	F	AP.04840	RP.04840.1	
	R	AP.03830	RP.03830.1	
2/98-01 4 CYL.	F	AP.04840	RP.04840.1	
	R			
2/98-01 V6	F	AP.08660	RP.08660.1	
	R	AP.03830	RP.03830.1	
02-03 4 CYL.	F	AP.08660	RP.08660.1	
	R			
02-03 V6	F	AP.08660	RP.08660.1	
	R	AP.03830	RP.03830.1	
04-07 4 CYL. (2.4L)	F	AP.08660	RP.08660.1	
	R	AP.03830	RP.03830.1	
04-07 V6 (3.8L), EXC RALLIART	F	AP.08660	RP.08660.1	
	R	AP.03830	RP.03830.1	
04-07 V6 (3.8L), 07 RALLIART	F	AP.08660	RP.08660.1	
	R	AP.05320	RP.05320.1	
<b>LANCER (EXC EVOLUTION)</b>				
02-04 ES	F	AP.09040	RP.09040.1	
	R			
02-04 LS	F	AP.09040	RP.09040.1	
	R			
02-04 O-Z RALLY EDITION	F	AP.09040	RP.09040.1	
	R			
04 RALLIART, SPORTSBACK	F	AP.08660	RP.08660.1	
	R			
05-06 ES SEDAN, O-Z RALLY	F	AP.09040	RP.09040.1	
	R			
05-06 RALLIART	F	AP.08660	RP.08660.1	

# BRAKE PAD

AXXIS PAD CERAMIC PAD

MAKE/MODEL	AXLE	ULTIMATE	H2	NOTES
YEAR	F/R	PART #	PART #	
	R			
<b>LANCER EVOLUTION AWD</b>				
2/98-06 V, VI, VII, VIII, MR (W/ BREMBO CALIPER)	F R	AP.10010 AP.09610	RP.10010.1 RP.09610.1	
<b>MIRAGE</b>				
6/98-02 14" WHEEL	F R	AP.04840	RP.04840.1	
<b>MONTERO V6 (EXC SPORT)</b>				
10/91-1/00	F R	AP.05300	RP.05300.1	
<b>MONTERO SPORT</b>				
97-04 2WD, 4WD	F R	AP.05300	RP.05300.1	
<b>OUTLANDER</b>				
03-04	F R	AP.08660	RP.08660.1	
05-06	F R	AP.05300	RP.05300.1	
07	F R	AP.08660	RP.08660.1	
<b>RAIDER</b>				
06-07	F R		RP.10840.1	
<b>STARION</b>				
83-87 4 LUG, 5 LUG	F R	AP.03890		
<b>3000 GT, GT-SL</b>				
90-99	F R	AP.05300 AP.03830	RP.05300.1 RP.03830.1	
<b>3000 GT-VR4</b>				
4/90-5/93	F R	AP.05320	RP.05320.1	
<b>NISSAN</b>				
<b>ALTIMA</b>				
93-01 W/ REAR DRUM	F R	AP.06530	RP.06530.1	
93-01 W/ REAR DISC	F R	AP.06530 AP.05400	RP.06530.1 RP.05400.1	
02-04	F R	AP.08151 AP.09050	RP.08151.1 RP.09050.1	
05-06 EXC SE-R	F R	AP.08151 AP.09050	RP.08151.1 RP.09050.1	
05-06 SE-R	F R	AP.09690 AP.09050	RP.09690.1 RP.09050.1	
<b>ARMADA</b>				
04-3/05	F R	AP.10150 AP.10410		
3/05-07	F R	AP.10410		
<b>FRONTIER 2WD</b>				
98-02 ALL MODEL	F R	AP.03330		
03-04 4 CYL.	F R	AP.03330		
03-04 V6	F R	AP.08300		
<b>FRONTIER 4WD</b>				
9/97-02	F R	AP.03330		
03-04	F R	AP.08300		
<b>MAXIMA</b>				
9/89-8/90 W/ REAR DRUM	F R	AP.06530	RP.06530.1	
9/89-8/90 W/ REAR DISC	F R	AP.06530 AP.03230	RP.06530.1	
9/90-1/94 W/ REAR DRUM	F	AP.06530	RP.06530.1	

# BRAKE PAD

AXXIS PAD CERAMIC PAD

MAKE/MODEL	AXLE	ULTIMATE	H2	NOTES
YEAR	F/R	PART #	PART #	
	R			
9/90-1/94 W/ REAR DISC	F	AP.06530	RP.06530.1	
	R	AP.05400	RP.05400.1	
2/94-3/99	F	AP.06530	RP.06530.1	
	R	AP.05400	RP.05400.1	
4/99-10/00	F	AP.06530	RP.06530.1	
	R	AP.05400	RP.05400.1	
11/00-01	F	AP.06530	RP.06530.1	
	R	AP.09000		
02-03	F	AP.08151	RP.08151.1	
	R	AP.09000		
04-07	F	AP.09690	RP.09690.1	
	R	AP.09050	RP.09050.1	
<b>MURANO</b>				
03-07	F	AP.09690	RP.09690.1	
	R	AP.09050	RP.09050.1	
<b>NX COUPE</b>				
91-93 1.6L	F	AP.05100		
	R	AP.05110		
91-93 2.0L W/O ABS (EXC SE, SER)	F	AP.05090		
	R	AP.05110		
91-93 2.0L W/ ABS (SE, SER W/O ABS)	F	AP.05490		
	R	AP.05110		
<b>PATHFINDER</b>				
86-95	F	AP.03330		
	R			
96-7/97	F	AP.06910	RP.06910.1	
	R			
12/98-04	F	AP.06910	RP.06910.1	
	R			
<b>QUEST</b>				
04-07	F	AP.06910	RP.06910.1	
	R	AP.09050	RP.09050.1	
<b>SENTRA</b>				
91-94 1.6L (W/ REAR DRUM)	F	AP.05100		
	R			
91-94 1.6L (W/ REAR DISC)	F	AP.05100		
	R	AP.05110		
91-94 2.0L (MADE IN USA)	F	AP.05100		
	R	AP.05110		
91-94 2.0L (MADE IN JAPAN)	F	AP.05490		
	R	AP.05110		
95-97 W/ REAR DRUM	F	AP.06680	RP.06680.1	
	R			
95-97 W/ REAR DISC	F	AP.06680	RP.06680.1	
	R			
98-99 1.6L (E, XE) W/ REAR DRUM	F	AP.06680	RP.06680.1	
	R			
98-99 1.6L (GLE, GXE) W/ REAR DRUM	F	AP.06680	RP.06680.1	
	R			
98-99 1.6L (GLE, GXE) W/ REAR DISC	F	AP.06680	RP.06680.1	
	R			
98-99 2.0L (SE)	F	AP.06680	RP.06680.1	
	R			
00-8/01 1.8L (XE, GXE) W/ REAR DRUM	F	AP.07000	RP.07000.1	
	R			
00-6/01 2.0L (SE) W/ REAR DISC	F	AP.06530	RP.06530.1	
	R	AP.05400	RP.05400.1	
7/01-8/01 2.0L (SE) W/ REAR DISC	F	AP.06530	RP.06530.1	
	R	AP.09000		
02-4/03 1.8L (XE, GXE) W/ REAR DRUM	F	AP.07000	RP.07000.1	
	R			
02-4/03 2.5L (SE-R)	F	AP.06530	RP.06530.1	
	R	AP.09000		
5/03-06 1.8L (BASIC, S)	F	AP.07000	RP.07000.1	
	R			
5/03-06 2.5L (S, SE-R)	F	AP.06530	RP.06530.1	
	R	AP.09000		

# BRAKE PAD

AXXIS PAD CERAMIC PAD

MAKE/MODEL		AXLE	ULTIMATE	H2	NOTES
YEAR		F/R	PART #	PART #	
5/03-06	2.5L SE-R SPEC V (W/ FRONT BREMBO CALIPER)	F R	AP.09600 AP.09000	RP.09600.1	
<b>SKYLINE (JAPAN)</b>					
2/93-02	GT-R (R32, R33, R34) W/ BREMBO CALIPER	F R	AP.09600 AP.09610	RP.09600.1 RP.09610.1	
<b>TITAN</b>					
04-3/05		F R	AP.10150 AP.10410		
4/05-07		F R	AP.10410		
<b>VERSA</b>					
07		F R	AP.08151		
<b>XTERRA</b>					
00-04		F R	AP.08300		
<b>200SX</b>					
95-99		F R	AP.06680	RP.06680.1	
<b>240SX</b>					
89-1/94	W/O ABS	F R	AP.04220 AP.02720	RP.04220.1 RP.02720.1	
89-1/94	W/ ABS	F R	AP.07000 AP.02720	RP.07000.1 RP.02720.1	
2/94-6/96		F R	AP.04220 AP.02720	RP.04220.1 RP.02720.1	
7/96-98		F R	AP.07000 AP.02720	RP.07000.1 RP.02720.1	
<b>240Z, 260Z, 280Z</b>					
70-78		F R	AP.01140		
<b>280Z (TURBO)</b>					
82-83		F R	AP.02720	RP.02720.1	
<b>300ZX (EXC TURBO)</b>					
84-1/89		F R	AP.02660 AP.02720	RP.02720.1	
2/89-96		F R	AP.06470 AP.04610	RP.06470.1 RP.04610.1	
<b>300ZX (TURBO)</b>					
84-86		F R	AP.02660 AP.02720	RP.02720.1	
87-1/89		F R	AP.02720	RP.02720.1	
2/89-96		F R	AP.06470 AP.04610	RP.06470.1 RP.04610.1	
<b>350Z</b>					
6/02-05	BASE MODEL	F R	AP.06530 AP.09050	RP.06530.1 RP.09050.1	
6/02-05	W/ BREMBO CALIPER	F R	AP.09600 AP.09610	RP.09600.1 RP.09610.1	
06-07	BASE MODEL	F R	AP.08880 AP.09050	RP.08880.1 RP.09050.1	
06-07	W/ BREMBO CALIPER	F R	AP.09600 AP.09610	RP.09600.1 RP.09610.1	
<b>OLDSMOBILE</b>					
<b>ACHIEVA</b>					
92-98		F R	AP.05060	RP.05060.1	
<b>ALERO</b>					
99-04		F R	AP.07270		
<b>BRAVADA</b>					
91-96		F R	AP.01540		
97-01		F R		RP.07260.1 RP.07290.1	

# BRAKE PAD

AXXIS PAD CERAMIC PAD

MAKE/MODEL	AXLE	ULTIMATE	H2	NOTES
YEAR	F/R	PART #	PART #	
02-04	F R		RP.08820.1 RP.08830.1	
<b>PLYMOUTH</b>				
<b>LASER</b>				
4/89-92	F R	AP.04840 AP.03290	RP.04840.1 RP.03290.1	
93-94 EXC 4WD TURBO	F R	AP.04840 AP.03290	RP.04840.1 RP.03290.1	
93-94 4WD TURBO	F R	AP.05300 AP.03290	RP.05300.1 RP.03290.1	
<b>PROWLER</b>				
97-01	F R	AP.05910		
<b>PONTIAC</b>				
<b>BONNEVILLE</b>				
90-91	F R	AP.02150		
<b>FIREBIRD</b>				
89-92	F R	AP.01540 AP.04130	RP.04130.1	
89-92 W/ PERFORMANCE PKG, TURBO	F R	AP.04120 AP.04130	RP.04120.1 RP.04130.1	
98-02	F R	AP.07490		
<b>G5, G5 PURSUIT</b>				
05-07 GT (2.4L)	F R		RP.10280.1	
<b>G6</b>				
05-07	F R		RP.10280.1	
<b>GRAND AM</b>				
90 EXC PERFORMANCE PKG WS6	F R	AP.02890		
90-98 W/ PERFORMANCE PKG WS6	F R	AP.05060	RP.05060.1	
99-04 W/ REAR DRUM	F R	AP.07270		
99-05 W/ REAR DISC	F R	AP.07270		
<b>GRAND PRIX</b>				
89-96	F R	AP.03760		
<b>GTO</b>				
04	F R	AP.10430 AP.10480		
<b>SOLSTICE</b>				
06-07	F R		RP.10280.1 RP.10950.1	
<b>SUNBIRD, SUNFIRE</b>				
89-91	F R	AP.02890		
92-05	F R	AP.05060	RP.05060.1	
<b>VIBE</b>				
03-06 GT (2WD) W/ REAR DISC	F R	AP.08230	RP.08230.1	
<b>PORSCHE</b>				
<b>BOXSTER (EXC S)</b>				
97-04	F R	AP.07370 AP.07380		
05-07	F R	AP.07370		
<b>BOXSTER S</b>				
00-07 EXC CERAMIC DISCS	F R	AP.07380		

# BRAKE PAD

AXXIS PAD CERAMIC PAD

MAKE/MODEL	AXLE	ULTIMATE	H2	NOTES
YEAR	F/R	PART #	PART #	
<b>CAYENNE</b>				
04-06 17" WHEEL	F R	AP.10070		
<b>CAYMAN</b>				
06-07 EXC CERAMIC DISCS	F R	AP.07380		
<b>911 CARRERA 2 (EXC TURBO &amp; TURBO LOOK, 2S)</b>				
90-91	F R	AP.06080		
92-93	F R	AP.06080 AP.06080		
94 TYPE 964	F R	AP.06080 AP.06080		
94 TYPE 993	F R	AP.06090 AP.06080		
95-97	F R	AP.06090 AP.06080		
98 TYPE 993	F R	AP.06090 AP.06080		
98 TYPE 996	F R	AP.07380		
99-07 TYPE 996, TYPE 997	F R	AP.07380		
<b>911 CARRERA 2 (TURBO LOOK &amp; CARRERA, 2S)</b>				
91-94	F R	AP.06090 AP.06080		
96-98	F R	AP.06090		
<b>911 CARRERA 4 (EXC TURBO &amp; TURBO LOOK, 4S)</b>				
90-94	F R	AP.06080 AP.06080		
95-98	F R	AP.06090 AP.06080		
99-07 TYPE 996, TYPE 997	F R	AP.07380		
<b>911 CARRERA 4 (TURBO LOOK &amp; CARRERA, 4S)</b>				
91-94	F R	AP.06080 AP.06080		
96-98	F R	AP.06090		
<b>928, CS, GT, GTS, S, S4</b>				
89-91	F R	AP.06090 AP.06080		
92-95	F R	AP.06080		
<b>944 SERIES (EXC TURBO)</b>				
90-91 EXC KONI SPORT SUSPENSION	F R	AP.06080 AP.06080		
90-91 W/ KONI SPORT SUSPENSION	F R	AP.06090 AP.06080		
<b>944 SERIES TURBO</b>				
89-91	F R	AP.06090 AP.06080		
<b>968</b>				
90-91 EXC SPORT	F R	AP.06080 AP.06080		
90-91 SPORT	F R	AP.06090 AP.06080		
<b>SAAB</b>				
<b>9-2X AWD</b>				
05-06 ALL MODEL	F R	AP.09290 AP.10040	RP.09290.1 RP.10040.1	
<b>9-3</b>				
98-99	F R	AP.07360 AP.07090		
00-02	F R	AP.08190 AP.07090		

# BRAKE PAD

AXXIS PAD CERAMIC PAD

MAKE/MODEL		AXLE	ULTIMATE	H2	NOTES
YEAR		F/R	PART #	PART #	
03	LINEAR (W/ 285MM FRONT DISC)	F R	AP.09720 AP.09730	RP.09730.1	
03	CONVERTIBLE W/ 288MM FRONT DISC ONLY	F R	AP.08190 AP.07090		
03	ARC, VECTOR (W/ 302MM FRONT DISC)	F R	AP.09720 AP.09730	RP.09730.1	
04	ALL MODEL	F R	AP.09720 AP.09730	RP.09730.1	
05	ALL MODEL	F R	AP.09720	RP.10950.1	
06-07	2.0T (2.0L TURBO) 285MM FRONT DISC AERO (2.8L) 302MM FRONT DISC	F R	AP.09720	RP.10950.1	
06-07	AERO (2.8L) 314MM FRONT DISC	F R		RP.10950.1	
<b>9-5</b>					
98-99		F R	AP.07360 AP.07090		
00-04		F R	AP.08190 AP.06920	RP.06920.1	
05-06	288MM FRONT DISC	F R	AP.08190 AP.06920	RP.06920.1	
05-07	308MM FRONT DISC	F R	AP.06920	RP.06920.1	
<b>9-7X</b>					
06-07		F R		RP.11690.1 RP.08830.1	
<b>900 SERIES</b>					
8/87-93		F R	AP.04930		
94-96		F R	AP.06440 AP.04270		
97-98		F R	AP.07360 AP.07090		
<b>9000 S</b>					
90-98		F R	AP.04030		
<b>9000 TURBO</b>					
88-98		F R	AP.04030		
<b>SATURN</b>					
<b>AURA</b>					
07		F R		RP.10280.1	
<b>ION</b>					
04-07	REDLINE	F R		RP.10280.1	
<b>L SERIES-SEDAN LS, WAGON LW</b>					
00-05		F R	AP.08190 AP.07090		
<b>SKY</b>					
07		F R		RP.10280.1 RP.10950.1	
<b>SCION</b>					
<b>xA, xB</b>					
04-07		F R	AP.08220	RP.08220.1	
<b>tC</b>					
05-07		F R	AP.08170 AP.08350	RP.08170.1 RP.08350.1	
<b>SUBARU</b>					
<b>BAJA</b>					
03-06	ALL MODEL	F R	AP.09290 AP.07700	RP.09290.1 RP.07700.1	
<b>FORESTER</b>					
98-2/02	L (W/ REAR DRUM)	F	AP.07210	RP.07210.1	

# BRAKE PAD

AXXIS PAD CERAMIC PAD

MAKE/MODEL		AXLE	ULTIMATE	H2	NOTES
YEAR		F/R	PART #	PART #	
		R			
98-2/02	S (W/ REAR DISC)	F	AP.07210	RP.07210.1	
		R	AP.07700	RP.07700.1	
3/02-3/03	2.5X (W/ REAR DRUM)	F	AP.09290	RP.09290.1	
		R			
3/02-3/03	2.5XS (W/ REAR DISC)	F	AP.09290	RP.09290.1	
		R	AP.07700	RP.07700.1	
3/03-07	2.5X (W/ REAR DRUM)	F	AP.09290	RP.09290.1	
		R			
3/03-07	2.5XT TURBO, 2.5X L	F	AP.09290	RP.09290.1	
		R	AP.10040	RP.10040.1	
<b>IMPREZA COUPE, SEDAN (EXC WRX)</b>					
11/92-96	W/ REAR DISC	F			
		R	AP.04710		
97		F	AP.07220		
		R			
98-6/98	EXC RS	F	AP.07220		
		R			
98-6/98	RS	F	AP.07210	RP.07210.1	
		R	AP.04710		
7/98-01	EXC RS	F	AP.07220		
		R			
7/98-01	RS	F	AP.07210	RP.07210.1	
		R	AP.07700	RP.07700.1	
02	RS	F	AP.09290	RP.09290.1	
		R	AP.07700	RP.07700.1	
03-07	RS	F	AP.09290	RP.09290.1	
		R	AP.10040	RP.10040.1	
<b>IMPREZA OUTBACK</b>					
97-01		F	AP.07220		
		R			
02		F	AP.09290	RP.09290.1	
		R			
03-07	W/ REAR DISC	F	AP.09290	RP.09290.1	
		R	AP.10040	RP.10040.1	
<b>IMPREZA (WRX, STi)</b>					
02	WRX	F	AP.07210	RP.07210.1	
		R	AP.07700	RP.07700.1	
03-05	WRX (EXC STi)	F	AP.09290	RP.09290.1	
		R	AP.10040	RP.10040.1	
03-05	STi (W/ BREMBO CALIPER)	F	AP.10010	RP.10010.1	
		R	AP.09610	RP.09610.1	
06-07	WRX (EXC STi)	F		RP.11820.1	
		R		RP.04611.1	
06-07	STi (W/ BREMBO CALIPER)	F	AP.10010	RP.10010.1	
		R	AP.09610	RP.09610.1	
<b>LEGACY (SEDAN)</b>					
90-96	W/ REAR DISC	F			
		R	AP.04710		
97-99	GT	F	AP.07210	RP.07210.1	
		R	AP.04710		
97-99	L (W/ REAR DRUM)	F	AP.07220		
		R			
97-99	L (W/ REAR DISC)	F	AP.07220		
		R	AP.04710		
97-98	LS, LTD	F	AP.07210	RP.07210.1	
		R	AP.04710		
00-01	ALL MODEL	F	AP.07210	RP.07210.1	
		R	AP.07700	RP.07700.1	
02-4/02	L, LS	F	AP.07210	RP.07210.1	
		R	AP.07700	RP.07700.1	
02-4/02	L, L-S	F	AP.07210	RP.07210.1	
		R	AP.07700	RP.07700.1	
02-4/02	GT, GT LTD	F	AP.09290	RP.09290.1	
		R	AP.07700	RP.07700.1	
5/02-04	ALL MODEL	F	AP.09290	RP.09290.1	
		R	AP.07700	RP.07700.1	
05-07	2.5i	F	AP.09290	RP.09290.1	



# BRAKE PAD

AXXIS PAD CERAMIC PAD

MAKE/MODEL	AXLE	ULTIMATE	H2	NOTES
YEAR	F/R	PART #	PART #	
	R		RP.11140.1	
05-07 2.5 GT	F		RP.10780.1	
	R	AP.07700	RP.07700.1	
<b>LEGACY (WAGON)</b>				
90-96 W/ REAR DISC	F			
	R	AP.04710		
97-99 BRIGHTON	F	AP.07220		
	R			
97-99 GT, LSi	F	AP.07210	RP.07210.1	
	R	AP.04710		
97-99 L, LS (W/ REAR DISC)	F	AP.07220		
	R	AP.04710		
97-98 OUTBACK	F	AP.07210	RP.07210.1	
	R	AP.04710		
00-4/01 BRIGHTON	F	AP.07220		
	R	AP.07700	RP.07700.1	
00-01 GT, L	F	AP.07210	RP.07210.1	
	R	AP.07700	RP.07700.1	
5/01-4/02 BRIGHTON	F	AP.07210	RP.07210.1	
	R			
02-4/02 L, LS	F	AP.07210	RP.07210.1	
	R	AP.07700	RP.07700.1	
02-4/02 GT	F	AP.09290	RP.09290.1	
	R	AP.07700	RP.07700.1	
5/02-04 ALL MODEL	F	AP.09290	RP.09290.1	
	R	AP.07700	RP.07700.1	
05-07 2.5i	F	AP.09290	RP.09290.1	
	R		RP.11140.1	
05-07 2.5 GT	F		RP.10780.1	
	R	AP.07700	RP.07700.1	
<b>OUTBACK</b>				
00-01	F	AP.07210	RP.07210.1	
	R	AP.07700	RP.07700.1	
02-04	F	AP.09290	RP.09290.1	
	R	AP.07700	RP.07700.1	
05-07 ALL MODEL	F	AP.09290	RP.09290.1	
	R		RP.11140.1	
<b>SVX</b>				
92-97	F	AP.03330		
	R	AP.04710		
<b>TRIBECA</b>				
06-07	F		RP.10780.1	
	R			
<b>SUZUKI</b>				
<b>SX4</b>				
07	F	AP.06530	RP.06530.1	
	R	AP.05370	RP.05370.1	
<b>TOYOTA</b>				
<b>AVALON</b>				
95-97	F	AP.04760		
	R			
98-99	F	AP.07070	RP.07070.1	
	R			
00-04	F	AP.07070	RP.07070.1	
	R			
<b>CAMRY (COUPE, SEDAN)</b>				
90-91 4 CYL. (EXC ALL-TRAC W/ REAR DRUM)	F	AP.03560	RP.03560.1	
	R			
90-91 6 CYL.	F	AP.03560	RP.03560.1	
	R	AP.03250	RP.03250.1	
90-91 ALL-TRAC	F	AP.03560	RP.03560.1	
	R	AP.03250	RP.03250.1	
92-99 4 CYL. (W/ REAR DRUM)	F	AP.05620		
	R			
92-99 4 CYL. (W/ REAR DISC)	F	AP.05620		
	R	AP.03250	RP.03250.1	

# BRAKE PAD

AXXIS PAD CERAMIC PAD

MAKE/MODEL		AXLE	ULTIMATE	H2	NOTES
YEAR		F/R	PART #	PART #	
92-99	6 CYL. (W/ REAR DRUM)	F R	AP.04760		
92-99	6 CYL. (W/ REAR DISC)	F R	AP.04760 AP.03250	RP.03250.1	
00-01	4 CYL. (14" WHEEL)	F R	AP.05620		
00-01	4 CYL. (15" WHEEL)	F R	AP.04760		
00-01	6 CYL. (MADE IN USA)	F R	AP.07070	RP.07070.1	
00-01	6 CYL. (MADE IN JAPAN)	F R	AP.07070 AP.08350	RP.07070.1 RP.08350.1	
02-06	4 CYL. (LE) W/ REAR DRUM	F R	AP.09080		
02-06	4 CYL. (SE, XLE) MADE IN USA	F R	AP.09080		
02-06	4 CYL. (SE, XLE) MADE IN JAPAN	F R	AP.09080		
02-06	6 CYL. (LE 3.0L, SE, XLE) MADE IN USA	F R	AP.09080		
02-06	6 CYL. (LE 3.0L, SE, XLE) MADE IN JAPAN	F R	AP.09080		
<b>CELICA</b>					
90-91	GT	F R	AP.03560	RP.03560.1	
90-91	GT-S	F R	AP.03560 AP.03250	RP.03560.1 RP.03250.1	
90-91	ST	F R	AP.02420	RP.02420.1	
90-91	ALL TRAC TURBO	F R	AP.03560 AP.03250	RP.03560.1 RP.03250.1	
92-93	CONVERTIBLE, GT, GT-S	F R	AP.03560 AP.03250	RP.03560.1 RP.03250.1	
92-93	ST	F R	AP.03560	RP.03560.1	
92-93	ALL TRAC TURBO	F R	AP.03560 AP.03250	RP.03560.1 RP.03250.1	
95-97	CONVERTIBLE, GT	F R	AP.03560 AP.03250	RP.03560.1 RP.03250.1	
95-97	ST	F R	AP.05620		
98-99	ALL MODEL	F R	AP.04760 AP.03250	RP.03250.1	
00	GT	F R	AP.08220	RP.08220.1	
00	GTS	F R	AP.08170 AP.08230	RP.08170.1 RP.08230.1	
01-05	GT	F R	AP.08170	RP.08170.1	
01-05	GTS	F R	AP.08170 AP.08230	RP.08170.1 RP.08230.1	
<b>COROLLA</b>					
88-91	COUPE GT-S	F R	AP.02420	RP.02420.1	
88-91	EXC COUPE GT-S	F R	AP.02420	RP.02420.1	
92		F R	AP.02420	RP.02420.1	
93-97		F R	AP.05620		
98-02		F R	AP.07410		
05-06	W/ REAR DISC	F R	AP.08230	RP.08230.1	
<b>ECHO</b>					
01-05		F R	AP.08220	RP.08220.1	
<b>FJ CRUISER</b>					

# BRAKE PAD

AXXIS PAD CERAMIC PAD

MAKE/MODEL	AXLE	ULTIMATE	H2	NOTES
YEAR	F/R	PART #	PART #	
07	F R	AP.09760 AP.06060	RP.09760.1 RP.06060.1	
<b>HIGHLANDER</b>				
06 HV (HYBRID)	F R	AP.10050		
<b>LANDCRUISER</b>				
90-97	F R	AP.05020 AP.06060	RP.06060.1	
98-07	F R	AP.07720 AP.07730		
<b>MATRIX</b>				
03-06 W/ REAR DISC	F R	AP.08230	RP.08230.1	
<b>MR 2, MRS SPYDER (EXC TURBO)</b>				
85-89	F R	AP.02420 AP.03090	RP.02420.1	
90-95	F R	AP.02420 AP.06570	RP.02420.1 RP.06570.1	
00-05	F R	AP.08220 AP.06570	RP.08220.1 RP.06570.1	
<b>MR 2 TURBO</b>				
90-91	F R	AP.04890 AP.06570	RP.04890.1 RP.06570.1	
92-95	F R	AP.05820 AP.06570	RP.06570.1	
<b>PRIUS</b>				
00-07	F R	AP.08220	RP.08220.1	
<b>RAV 4</b>				
96-00	F R	AP.05620		
01-05	F R	AP.08620		
<b>SEQUOIA</b>				
01-02 ORIGINAL FRONT CALIPER	F R	AP.08120 AP.06060	RP.06060.1	
01-02 RETROFIT FRONT CALIPER	F R	AP.09760 AP.06060	RP.09760.1 RP.06060.1	
03-07	F R	AP.09760 AP.06060	RP.09760.1 RP.06060.1	
<b>SIENNA</b>				
98-03	F R	AP.04760		
<b>SOLARA</b>				
99	F R	AP.07070	RP.07070.1	
00-03	F R	AP.07070	RP.07070.1	
<b>SUPRA</b>				
86-92	F R	AP.04350 AP.06220	RP.04350.1 RP.06220.1	
93-98 EXC TURBO	F R	AP.06190 AP.05720	RP.06190.1	
93-98 TURBO	F R		RP.06290.1 RP.06300.1	
<b>TERCEL</b>				
91-98	F R	AP.02420	RP.02420.1	
<b>TACOMA</b>				
95-1/98 4WD	F R	AP.04360		
2/98-00 2WD PRE-RUNNER	F R	AP.04360		
2/98-00 4WD	F R	AP.04360		
01-04 4WD	F R	AP.04360		
05-07 ALL MODEL (EXC 2WD)	F	AP.09760	RP.09760.1	

# BRAKE PAD

AXXIS PAD CERAMIC PAD

MAKE/MODEL	AXLE	ULTIMATE	H2	NOTES
YEAR	F/R	PART #	PART #	
	R			
<b>TUNDRA</b>				
00-02 2WD, 4WD (CALIPER CAST #S13WE)	F	AP.08120		
	R			
00-02 2WD, 4WD (CALIPER CAST #13WL)	F	AP.09760	RP.09760.1	
	R			
03-06	F	AP.09760	RP.09760.1	
	R			
<b>T100 PICKUP</b>				
93-98 4WD	F	AP.06110		
	R			
<b>4 RUNNER</b>				
89-5/91	F	AP.04100		
	R			
6/91-10/95	F	AP.06110		
	R			
11/95-02	F	AP.04360		
	R			
03-07	F	AP.09760	RP.09760.1	
	R	AP.06060	RP.06060.1	
<b>VOLKSWAGEN</b>				
<b>CABRIO, CABRIOLET</b>				
84-93	F	AP.05690		
	R			
94-98	F	AP.06960		
	R			
99-02	F	AP.06960		
	R	AP.03400	RP.03400.1	
<b>CORRADO</b>				
89-95 1.8L, 2.8L	F	AP.07800		
	R	AP.03400	RP.03400.1	
<b>EOS</b>				
07	F		RP.11070.1	
	R		RP.11080.1	
<b>GOLF GL, GLS, III, LE (EXC GLS, 1.8 TURBO)</b>				
93-94	F	AP.06960		
	R	AP.03400	RP.03400.1	
95 W/ REAR DRUM	F	AP.06960		
	R			
95 W/ REAR DISC	F	AP.06960		
	R	AP.03400	RP.03400.1	
96 TDI 1.9L	F	AP.07800		
	R			
96 GL 2.0L (W/ REAR DRUM)	F	AP.06960		
	R			
96 GL 2.0L (W/ REAR DISC)	F	AP.06960		
	R	AP.03400	RP.03400.1	
97-11/98 USA MODEL (W/ REAR DRUM)	F	AP.06960		
	R			
97-11/98 USA MODEL (W/ REAR DISC)	F	AP.06960		
	R	AP.03400	RP.03400.1	
12/98-6/99 W/ PAD SENSOR	F	AP.07681		
	R	AP.03400	RP.03400.1	
12/98-6/99 W/O PAD SENSOR	F	AP.07680		
	R	AP.03400	RP.03400.1	
7/99-06	F	AP.07681		
	R	AP.03400	RP.03400.1	
<b>GOLF GTi, GLS TURBO, GLX (VR6), 1.8 TURBO, VR6</b>				
8/89-92 8, 16 VALVE	F	AP.05690		
	R			
95 VR6, GOLF III	F	AP.06840	RP.06840.1	
	R	AP.03400	RP.03400.1	
96-11/98 2.0L (4 CYL.)	F	AP.06960		
	R	AP.03400	RP.03400.1	
96-11/98 VR6	F	AP.06870	RP.06870.1	
	R	AP.03400	RP.03400.1	
12/98-05	F	AP.06871		

# BRAKE PAD

AXXIS PAD CERAMIC PAD

MAKE/MODEL	AXLE	ULTIMATE	H2	NOTES
YEAR	F/R	PART #	PART #	
	R	AP.03400	RP.03400.1	
06-07	F		RP.11070.1	
	R		RP.11080.1	
<b>GOLF R32 (AWD)</b>				
04	F	AP.06820		
	R	AP.03400	RP.03400.1	
<b>JETTA (EXC JETTA WAGON)</b>				
90-92 W/ REAR DISC	F	AP.06960		
	R	AP.03400	RP.03400.1	
93 W/ REAR DRUM	F	AP.06960		
93 W/ REAR DISC	F	AP.06960		
	R	AP.03400	RP.03400.1	
94-95 W/ REAR DRUM	F	AP.06960		
	R			
94-95 W/ REAR DISC	F	AP.06960		
	R	AP.03400	RP.03400.1	
94-95 VR6	F	AP.06840	RP.06840.1	
	R	AP.03400	RP.03400.1	
96 USA MODEL (1.9 TURBO DIESEL)	F	AP.07800		
	R			
96 W/ REAR DRUM	F	AP.06960		
	R			
96 W/ REAR DISC	F	AP.06960		
	R	AP.03400	RP.03400.1	
96 VR6	F	AP.06870	RP.06870.1	
	R	AP.03400	RP.03400.1	
97-9/98 W/ REAR DRUM	F	AP.06960		
	R			
97-9/98 W/ REAR DISC	F	AP.06960		
	R	AP.03400	RP.03400.1	
97-9/98 VR6	F	AP.06870	RP.06870.1	
	R	AP.03400	RP.03400.1	
10/98-7/99 TDI, 2.0L (W/ PAD SENSOR)	F	AP.07681		
	R	AP.03400	RP.03400.1	
10/98-7/99 TDI, 2.0L (W/O PAD SENSOR)	F	AP.07680		
	R	AP.03400	RP.03400.1	
10/98-7/99 VR6 (W/ PAD SENSOR)	F	AP.06871		
	R	AP.03400	RP.03400.1	
10/98-7/99 VR6 (W/O PAD SENSOR)	F	AP.06870	RP.06870.1	
	R	AP.03400	RP.03400.1	
8/99-04 TDI, 2.0L	F	AP.07681		
	R	AP.03400	RP.03400.1	
8/99-04 1.8 TURBO, VR6	F	AP.06871		
	R	AP.03400	RP.03400.1	
05-06 ALL MODEL	F		RP.11070.1	
	R		RP.11080.1	
07 2.0L GAS	F	AP.07681		
CANADA MODEL	R	AP.03400	RP.03400.1	
07 TDI, 2.5L (5 CYL.), GLI, 2.0L TURBO	F		RP.11070.1	
	R		RP.11080.1	
<b>JETTA WAGON</b>				
01-05	F	AP.07681		
	R	AP.03400	RP.03400.1	
<b>NEW BEETLE</b>				
98-5/99	F	AP.07680		
	R	AP.03400	RP.03400.1	
6/99-05 EXC TURBO	F	AP.07681		
	R	AP.03400	RP.03400.1	
6/99-05 TURBO	F	AP.06871		
	R	AP.03400	RP.03400.1	
06-07 1.9 TDI	F	AP.07681		
	R	AP.03400	RP.03400.1	
06-07 2.5 (5 CYL.)	F	AP.06871		
	R	AP.03400	RP.03400.1	
<b>PASAT (EXC SYNCRO)</b>				
90-92	F	AP.06960		
	R	AP.03400	RP.03400.1	

# BRAKE PAD

AXXIS PAD CERAMIC PAD

MAKE/MODEL		AXLE	ULTIMATE	H2	NOTES
YEAR		F/R	PART #	PART #	
93	GL (4 CYL.)	F	AP.06960		
		R	AP.03400	RP.03400.1	
93	GLX (VR6)	F	AP.07800		
		R	AP.03400	RP.03400.1	
94	GLX	F	AP.07800		
		R	AP.03400	RP.03400.1	
95	GLS (4 CYL.)	F	AP.06960		
		R	AP.03400	RP.03400.1	
95	GLX (VR6)	F	AP.07800		
		R	AP.03400	RP.03400.1	
96-97	TDI (CANADA ONLY)	F	AP.07800		
		R			
96-97	GLS, TDI (USA ONLY)	F	AP.06960		
		R	AP.03400	RP.03400.1	
96-97	GLX (VR6)	F	AP.06870	RP.06870.1	
		R	AP.03400	RP.03400.1	
98-5/99		F	AP.07360		
		R	AP.03400	RP.03400.1	
5/99-01		F	AP.08400	RP.08400.1	
		R	AP.03400	RP.03400.1	
02-05	EXC W8	F	AP.08400	RP.08400.1	
		R	AP.03400	RP.03400.1	
02-05	W8	F	AP.08390		
		R	AP.03400	RP.03400.1	
06-07	2.0L TURBO, 3.6L EXC 4-MOTION	F		RP.11070.1	
		R		RP.11080.1	
06-07	4-MOTION (3.6L)	F			
		R		RP.11080.1	
<b>RABBIT</b>					
07		F		RP.11070.1	
		R		RP.11080.1	
<b>TOUAREG</b>					
04-05	330MM FRONT DISC	F	AP.10070		
		R			
06-07	V8 (4.2L), 330MM FRONT DISC	F	AP.10070		
		R			
<b>VOLVO</b>					
<b>C30</b>					
07		F	AP.10440	RP.10440.1	
		R		RP.10950.1	
<b>C70</b>					
98-04		F	AP.06180		
		R	AP.00310		
06-07		F	AP.10440	RP.10440.1	
		R		RP.10950.1	
<b>S40</b>					
05	2.4i	F	AP.10440	RP.10440.1	
		R	AP.09730	RP.09730.1	
05	T5	F		RP.09152.1	
		R	AP.09730	RP.09730.1	
06-07	2.4i	F	AP.10440	RP.10440.1	
		R		RP.10950.1	
05-07	T5	F		RP.09152.1	
		R		RP.10950.1	
<b>S60</b>					
01-03		F	AP.07940		
		R			
04-07	EXC R	F	AP.07940		
		R			
04-07	R	F	AP.10010	RP.10010.1	
		R			
<b>S70</b>					
98-00		F	AP.06180		
		R	AP.00310		
<b>S80</b>					
99-06		F	AP.07940		
		R			

# BRAKE PAD

AXXIS PAD CERAMIC PAD

MAKE/MODEL	AXLE	ULTIMATE	H2	NOTES
YEAR	F/R	PART #	PART #	
<b>S90</b>				
97-98	F	AP.05420		
	R	AP.03910		
<b>V50</b>				
05 2.4i	F	AP.10440	RP.10440.1	
	R	AP.09730	RP.09730.1	
05 T5	F		RP.09152.1	
	R	AP.09730	RP.09730.1	
06-07 2.4i	F	AP.10440	RP.10440.1	
	R		RP.10950.1	
05-07 T5	F		RP.09152.1	
	R		RP.10950.1	
<b>V70, V70 R (EXC XC)</b>				
98-00 2WD	F	AP.06180		
	R	AP.00310		
98-00 AWD	F	AP.06180		
	R	AP.03910		
01-03 EXC R	F	AP.07940		
	R			
04-07 EXC R	F	AP.07940		
	R			
04-07 R	F	AP.10010	RP.10010.1	
	R			
<b>V70 XC AWD</b>				
98-00	F	AP.06180		
	R	AP.03910		
01-02	F	AP.07940		
	R			
<b>V90</b>				
97-98	F	AP.05420		
	R	AP.03910		
<b>XC70 AWD</b>				
03-07	F	AP.07940		
	R			
<b>XC90</b>				
03-07 W/ 316MM FRONT DISC	F			
	R	AP.09800		
03-07 W/ 336MM FRONT DISC	F	AP.10030		
	R	AP.09800		

**GENERAL INFORMATION:**

ALL PRICES ARE PER AXLE SET

UNLESS OTHERWISE SPECIFIED, ALL BRAKE PADS ARE FOR NORTH AMERICAN VEHICLES

# STAINLESS STEEL BRAKE LINE

MAKE/MODEL	AXLE	PART #	LINE NO.	NOTES
YEAR	F/R			
<b>ACURA</b>				
<b>CL COUPE</b>				
97-99 ALL MODEL	F	L.40039	2	
	R	L.40325	4	
01-03 3.2L (V6)	F	L.40069	2	
	R	L.40348	2	
<b>CSX (CANADA)</b>				
06-07	F	L.40092	2	
	R	L.40362	2	
<b>EL (CANADA)</b>				
97-00	F	L.40059	2	
	R	L.40304	2	
01-05	F	L.40059	2	
	R	L.40350	2	
06	F	L.40059	2	
	R	L.40090	2	
<b>INTEGRA</b>				
86-89	F	L.40025	2	
	R	L.40313	2	
90-93	F	L.40039	2	
	R	L.40316	2	
94-01 ALL MODEL	F	L.40039	2	
	R	L.40328	2	
<b>LEGEND</b>				
89-90 COUPE	F	L.40045	2	
	R	L.40325	4	
89-90 SEDAN	F	L.40045	2	
	R	L.40318	4	
91-95 ALL MODEL	F	L.40057	2	
	R	L.40323	2	
<b>MDX</b>				
01-06	F	L.40069	2	
	R			
<b>NSX</b>				
91-93	F	L.40055	2	
	R	L.40330	2	
94-05	F	L.40055	2	
	R	L.40364	2	
<b>RL</b>				
96-04	F	L.40057	2	
	R	L.40332	2	
05-06	F	L.40101	2	
	R	L.40370	2	
<b>RSX</b>				
02-06 ALL MODEL	F	L.40072	2	
	R	L.40350	2	
<b>TL</b>				
95	F	L.40047	2	
	R	L.40325	4	
96-98 2.5L	F	L.40047	2	
	R	L.40325	4	
96-98 3.2L	F	L.40057	2	
	R	L.40325	4	
99-03 ALL MODEL	F	L.40069	2	
	R	L.40348	2	
04-07 EXC BREMBO CALIPER	F	L.40092	2	
	R	L.40366	2	
04-07 W/ BREMBO CALIPER	F	L.40352	2	
	R	L.40366	2	
<b>TSX</b>				
04-07	F	L.40092	2	
	R	L.40362	2	
<b>AUDI</b>				
<b>ALLROAD</b>				
01-06	F	L.33038	2	
	R	L.33353	2	
<b>A3</b>				



# STAINLESS STEEL BRAKE LINE

MAKE/MODEL	AXLE	PART #	LINE NO.	NOTES
YEAR	F/R			
06-08	F	L.33050	2	
	R	L.33369	2	
<b>A4 (EXC QUATTRO)</b>				
96-01	F	L.37020	2	
	R	L.33343	4	
02-07	F	L.33044	2	
	R	L.33352	2	
<b>A4 QUATTRO</b>				
96-4/96	F	L.33026	2	
	R	L.33337	4	
5/96-01	F	L.37020	2	
	R	L.33337	4	
02-07	F	L.33044	2	
	R	L.33352	2	
<b>A6 (EXC QUATTRO)</b>				
95-98 W/ AFC ENG	F	L.33028	2	
	R	L.33331	4	
98-04 ALL MODEL (AHA ENG)	F	L.37020	2	
	R	L.33346	4	
<b>A6 QUATTRO</b>				
95-98 W/ AFC ENG	F	L.33028	2	
	R	L.33339	2	
98-04 ALL MODEL (AHA ENG)	F	L.37020	2	
	R	L.33347	2	
<b>A8, A8 QUATTRO</b>				
97-8/99	F	L.33032	2	
	R	L.33345	2	
9/99-03	F	L.33032	2	
	R	L.33358	2	
04-06	F	L.33046	2	
	R			
<b>CABRIOLET - SEE A4 FROM 2002</b>				
94-98	F	L.33026	2	
	R	L.33321A	2	
<b>Q7</b>				
07-08	F	L.37021	2	
	R	L.37313	2	
<b>RS6</b>				
04	F	L.37020	2	
	R			
<b>S4</b>				
92-94	F	L.33028	2	
	R	L.33339	2	
2/99-02	F	L.37020	2	
	R	L.33337	4	
04-07	F	L.33044	2	
	R	L.33352	2	
<b>S6</b>				
95-98	F	L.33028	2	
	R	L.33339	2	
02-04	F	L.37020	2	
	R	L.33347	2	
<b>TT, TT QUATTRO</b>				
3/99-06	F	L.33043	2	
	R	L.33349	2	B
<b>BMW</b>				
<b>M3</b>				
87-91 E30	F	L.34000	2	
	R	L.33321A	2	
95-99 E36	F	L.34006	2	
	R	L.34302	4	
01-07 E46 (ALL MODEL)	F	L.34014	2	
	R	L.34308	2	
<b>M5</b>				
89-93	F	L.34002	2	
	R	L.33321	4	
00-04	F	L.34008	2	

# STAINLESS STEEL BRAKE LINE

MAKE/MODEL	AXLE	PART #	LINE NO.	NOTES
YEAR	F/R			
	R	L.34305	2	
06-07	F	L.34016	2	
	R	L.34000	2	
<b>M6</b>				
07	F	L.34016	2	
	R	L.34000	2	
<b>X5</b>				
00-06 ALL MODEL	F	L.34010	2	
	R	L.34310	2	
<b>Z3</b>				
96-97	F	L.34004	2	
	R	L.34307	4	
98-02 EXC M SERIES	F	L.34004	2	
	R	L.34307	4	
98-02 M SERIES	F	L.34006	2	
	R	L.34009	2	
<b>Z4</b>				
03-07 EXC M SERIES	F	L.34011	2	
	R	L.34313	2	
07 M SERIES	F	L.34014	2	
	R	L.34313	2	
<b>318i, iS</b>				
90-4/91 E30	F	L.34000	2	
	R	L.33321	4	
11/91-98 E36	F	L.34004	2	
	R	L.34302	4	
<b>318Ti</b>				
95-99	F	L.34004	2	
	R	L.33321	4	
<b>323 SERIES (E36, E46)</b>				
98-00 E36	F	L.34004	2	
	R	L.34302	4	
00 E46	F	L.34011	2	
	R	L.34308	2	
<b>325, 328 SERIES (E30, E36)</b>				
89-9/90 E30	F	L.34000	2	
	R	L.33321	4	
10/90-4/91 E30	F	L.34000	2	
	R	L.33321	4	
10/90-4/91 E36	F	L.34004	2	
	R	L.34302	4	
5/91-99 E36	F	L.34004	2	
	R	L.34302	4	
<b>325 SERIES (E46, E90)</b>				
01-05 E46 (EXC Xi-AWD)	F	L.34011	2	
	R	L.34308	2	
01-05 E46 (Xi-AWD)	F	L.34013	2	
	R	L.34308	2	
06 E46 (Ci COUPE & CONVERTIBLE)	F	L.34011	2	
	R	L.34308	2	
06 E90 (EXC Xi-AWD)	F	L.34018	2	
	R	L.34316	2	
07 E46 (CONVERTIBLE)	F	L.34011	2	
	R	L.34308	2	
<b>328 SERIES (E46, E90, E91, E92)</b>				
99-00 E46	F	L.34011	2	
	R	L.34308	2	
07 E90, E91, E92	F	L.34021	2	
	R	L.34316	2	
<b>330 SERIES (E46, E90)</b>				
01-05 E46 (EXC Xi-AWD)	F	L.34011	2	
	R	L.34308	2	
01-05 E46 (Xi-AWD)	F	L.34013	2	
	R	L.34308	2	
06 E46 (Ci COUPE & CONVERTIBLE)	F	L.34011	2	
	R	L.34308	2	
06 E90 (EXC Xi-AWD)	F	L.34018	2	
	R	L.34316	2	

# STAINLESS STEEL BRAKE LINE

MAKE/MODEL	AXLE	PART #	LINE NO.	NOTES
YEAR	F/R			
07 E46 (CONVERTIBLE)	F	L.34011	2	
	R	L.34308	2	
<b>335i SERIES (E90, E92)</b>				
07	F	L.34021	2	
	R	L.34316	2	
<b>525i</b>				
89-95	F	L.34002	2	
	R	L.33321	4	
01-03	F	L.34008	2	
	R	L.34305	2	
04-07	F	L.34016	2	
	R	L.34000	2	
<b>528i</b>				
96-00	F	L.34008	2	
	R	L.34305	2	
<b>530i</b>				
93-95	F	L.34002	2	
	R	L.33321A	2	
01-03	F	L.34008	2	
	R	L.34305	2	
04-07	F	L.34016	2	
	R	L.34000	2	
<b>535i, is</b>				
89-93	F	L.34002	2	
	R	L.33321	4	
<b>540i</b>				
93-95	F	L.34002	2	
	R	L.33321A	2	
96-03	F	L.34008	2	
	R	L.34305	2	
<b>545i (E60)</b>				
04-07	F	L.34016	2	
	R	L.34000	2	
<b>645Ci (E63, E64)</b>				
04-07	F	L.34016	2	
	R	L.34000	2	
<b>730i</b>				
92-93	F	L.34002	2	
	R	L.33321	4	
<b>735, 735i, 735iL</b>				
3/88-92	F	L.34002	2	
	R	L.33321	4	
<b>740i, 740iL</b>				
93-4/94	F	L.34002	2	
	R	L.33321	4	
5/94-97	F	L.34007	2	
	R	L.34305	2	
98-01	F	L.34009	2	
	R	L.34305	2	
<b>745i (E65), 745Li (E66)</b>				
02-05	F	L.34016	2	
	R	L.34000	2	
<b>750i, 750iL (E32, E38), 750i, 750Li (E65, E66)</b>				
88-94	F	L.34002	2	
	R	L.33321	4	
95-97	F	L.34007	2	
	R	L.34304	2	
98-01	F	L.34009	2	
	R	L.34305	2	
06-07	F	L.34016	2	
	R	L.34000	2	
<b>760i (E65), 760Li (E66)</b>				
03-07	F	L.34016	2	
	R	L.34000	2	
<b>840Ci</b>				
94-97	F	L.34002	2	
	R	L.33010	2	
<b>850Ci, 850i</b>				

# STAINLESS STEEL BRAKE LINE

MAKE/MODEL	AXLE	PART #	LINE NO.	NOTES
YEAR	F/R			
90-97	F	L.34002	2	
	R	L.33010	2	
<b>850CSI</b>				
94-95	F	L.34002	2	
	R	L.33010	2	
<b>CADILLAC</b>				
<b>ESCALADE</b>				
02-06	F	L.66098	2	
	R	L.66332	2	
<b>XLR</b>				
04-07	F	L.62116	2	
	R	L.62363	2	
<b>CHEVROLET</b>				
<b>AVALANCHE 1500</b>				
02-06	F	L.66098	2	
	R	L.66332	2	
<b>AVALANCHE 2500</b>				
03-06	F	L.66110	2	
	R			
<b>CAMARO</b>				
93-94	W/ REAR DRUM	F L.62337	2	
		R L.62356A	2	
93-94	W/ REAR DISC	F L.62337	2	
		R L.62356	4	
95-97	W/O REAR DISC/TRACTION	F L.62337	2	
		R L.62356	4	
95-97	W/ REAR DISC/TRACTION	F L.62337	2	
		R L.62369	4	
98-02		F L.62088	2	
	R			
<b>CORVETTE</b>				
89-92	F	L.62063	2	
	R	L.62344	4	
93	F	L.62078	2	
	R	L.62359	2	
94-96	F	L.62079	2	
	R	L.62359	2	
97-04	F	L.62089	2	
	R	L.62087	2	
05	F	L.62116	2	
	R	L.62363	2	
06-07	EXC Z06	F L.62116	2	
		R L.62363	2	
06-07	Z06	F L.62134	2	
	R	L.62424	2	
<b>SILVERADO 1500 (1/2 TON) 2WD</b>				
03-06	CREW CAB, HD	F L.66110	2	
		R		
<b>SILVERADO 1500 (1/2 TON) 4WD</b>				
99-04	EXC HD	F L.66098	2	
		R		
03-04	CREW CAB, HD	F L.66110	2	
		R		
05-06	EXC HD	F L.66098	2	
		R		
<b>SILVERADO 2500 (3/4 TON) (2WD, 4WD)</b>				
03-06		F L.66110	2	
		R		
<b>SILVERADO 3500 (1 TON) (2WD, 4WD)</b>				
03-06		F L.66110	2	
		R		
<b>SUBURBAN 1500 (1/2 TON) (2WD, 4WD)</b>				
00-06	W/ REAR DISC	F L.66098	2	
		R L.66332	2	
<b>SUBURBAN 2500 (3/4 TON) (2WD, 4WD)</b>				
03-06	W/ REAR DISC	F L.66110	2	

# STAINLESS STEEL BRAKE LINE

MAKE/MODEL	AXLE	PART #	LINE NO.	NOTES
YEAR	F/R			
	R			
<b>TAHOE (2WD &amp; 4WD)</b>				
00-06 W/ REAR DISC	F	L.66098	2	
	R	L.66332	2	
<b>CHRYSLER</b>				
<b>CROSSFIRE</b>				
04-05 EXC SRT-6	F	L.35016	2	
	R			
05 SRT-6	F	L.35016	2	
	R	L.35302	2	
<b>PT CRUISER</b>				
01-06	F	L.63062	2	
	R			
<b>SEBRING COUPE</b>				
95-00 W/ REAR DRUM	F	L.46056	2	
	R	L.46052	2	
95-00 W/ REAR DISC	F	L.46056	2	
	R	L.46020	2	
01-05 W/ REAR DRUM	F	L.46017	2	
	R	L.46052	2	
01-05 W/ REAR DISC	F	L.46017	2	
	R	L.46020	2	
<b>300, 300C</b>				
05-07 ALL MODEL (EXC SRT-8)	F	L.63076	2	
	R	L.63374	2	
<b>DODGE</b>				
<b>AVENGER</b>				
95-99 W/ REAR DRUM	F	L.46056	2	
	R	L.46052	2	
95-99 W/ REAR DISC	F	L.46056	2	
	R	L.46020	2	
00	F	L.46056	2	
	R	L.46020	2	
<b>CHARGER</b>				
06-07 ALL MODEL (EXC SRT-8)	F	L.63076	2	
	R	L.63374	2	
<b>MAGNUM</b>				
05-07 ALL MODEL (EXC SRT-8)	F	L.63076	2	
	R	L.63374	2	
<b>NEON</b>				
94-95 W/O ABS (W/ REAR DRUM)	F	L.63044	2	
	R	L.63326	2	
94-95 W/ ABS (W/ REAR DRUM)	F	L.63046	2	
	R	L.63326	2	
94-95 W/O ABS (W/ REAR DISC)	F	L.63044	2	
	R	L.63328	2	
94-95 W/ ABS (W/ REAR DISC)	F	L.63046	2	
	R	L.63328	2	
96-99 W/ REAR DRUM	F	L.63046	2	
	R	L.63326	2	
96-99 W/ REAR DISC	F	L.63046	2	
	R	L.63328	2	
<b>SRT-4</b>				
03-05	F	L.63062	2	
	R			
<b>STEALTH</b>				
91-96 2WD, AWD	F	L.46021	4	
	R	L.46043	4	
<b>STRATUS COUPE</b>				
01-05 W/ REAR DRUM	F	L.46017	2	
	R	L.46052	2	
01-05 W/ REAR DISC	F	L.46017	2	
	R	L.46020	2	
<b>VIPER</b>				
92-00	F	L.63042	2	
	R	L.63324	2	

# STAINLESS STEEL BRAKE LINE

MAKE/MODEL	AXLE	PART #	LINE NO.	NOTES
YEAR	F/R			
01-02	F	L.63064	2	
	R	L.63356	2	
03-08	F	L.63070	2	
	R	L.63366	2	
<b>EAGLE</b>				
<b>TALON (EXC TURBO)</b>				
90-94	F	L.46021	4	
	R	L.46043	4	
95-96	F	L.46056	2	
	R	L.46020	2	
97-99	F	L.46056	2	
	R	L.46052	2	
<b>TALON (TSi TURBO)</b>				
90-93 2WD, 4WD	F	L.46021	4	
	R	L.46043	4	
94 2WD	F	L.46021	4	
	R	L.46043	4	
94 4WD	F	L.46056	2	
	R	L.46020	2	
95-99 2WD, 4WD	F	L.46056	2	
	R	L.46020	2	
<b>FERRARI</b>				
<b>F355</b>				
94-99	F	L.10000	2	
	R	L.10004	2	
<b>F360, F360 STRADALE</b>				
00-05	F	L.10000	2	
	R	L.10002	2	
<b>348 GTB, GTS</b>				
89-95	F	L.10000	2	
	R	L.10004	2	
<b>FORD</b>				
<b>ESCORT, ZX2</b>				
91-93 W/ REAR DRUM	F	L.61050	2	
	R	L.45315	2	
91-93 W/ REAR DISC	F	L.61050	2	
	R	L.45324	2	
94-03 W/ REAR DRUM	F	L.61051	2	
	R	L.45315	2	
94-03 W/ REAR DISC	F	L.61051	2	
	R	L.45324	2	
<b>EXPEDITION</b>				
3/18/02-06	F	L.65154	2	
	R			
<b>FOCUS</b>				
00-04 ALL MODEL	F	L.61094	2	
	R			
<b>FUSION</b>				
06-07	F	L.45042	2	
	R	L.45345	2	
<b>MUSTANG</b>				
90-93 4 CYL.	F	L.61049	2	
	R	L.61312A	2	
90-93 8 CYL.	F	L.61052	2	
	R	L.61328	2	
94-98 EXC COBRA	F	L.61064	2	
	R	L.61312	4	
94-98 COBRA	F	L.61074	2	
	R			
99-04 ALL MODEL	F	L.61079	2	
	R			
05-07 ALL MODEL	F	L.61112	2	
	R	L.61422	2	
<b>GMC TRUCK, VAN</b>				

# STAINLESS STEEL BRAKE LINE

MAKE/MODEL	AXLE	PART #	LINE NO.	NOTES
YEAR	F/R			
<b>SIERRA 1500 (1/2 TON) 2WD</b>				
03-06 CREW CAB, HD	F R	L.66110	2	
<b>SIERRA 1500 (1/2 TON) 4WD</b>				
99-04 EXC HD	F R	L.66098	2	
03-04 CREW CAB, HD	F R	L.66110	2	
05-06 EXC HD	F R	L.66098	2	
<b>SIERRA 2500 (3/4 TON) (2WD, 4WD)</b>				
03-06	F R	L.66110	2	
<b>SIERRA 3500 (1 TON) (2WD, 4WD)</b>				
03-06	F R	L.66110	2	
<b>YUKON (2WD, 4WD) EXC XL</b>				
00-06 W/ REAR DISC	F R	L.66098 L.66332	2 2	
<b>YUKON XL (1/2 TON)</b>				
00-06 W/ REAR DISC	F R	L.66098 L.66332	2 2	
<b>YUKON XL (3/4 TON)</b>				
03-06 W/ REAR DISC	F R	L.66110	2	
<b>HONDA</b>				
<b>ACCORD (COUPE, SEDAN)</b>				
90-97 W/ REAR DRUM	F R	L.40039 L.40325A	2 2	
92-97 W/ REAR DISC	F R	L.40039 L.40325	2 4	
98-02 4 CYL. (W/ REAR DRUM)	F R	L.40069 L.40336	2 2	
98-02 V6, 4 CYL. (W/ REAR DISC)	F R	L.40069 L.40337	2 2	
03-07 W/ REAR DRUM	F R	L.40092 L.40352	2 2	
03-07 W/ REAR DISC	F R	L.40092 L.40356	2 2	
<b>CIVIC COUPE</b>				
93-95 DX 1500	F R	L.40049 L.40304	2 2	
93-95 EX 1600 (W/O ABS) REAR DRUM	F R	L.40039 L.40304	2 2	
93-95 EX 1600 (W/ ABS) REAR DISC	F R	L.40039 L.40328	2 2	
96-98 DX, HX	F R	L.40067 L.40304	2 2	
96-98 EX	F R	L.40059 L.40304	2 2	
99-00 DX, HX	F R	L.40067 L.40304	2 2	
99-00 EX	F R	L.40059 L.40304	2 2	
99-00 Si	F R	L.40059 L.40328	2 2	
01-05 ALL MODEL	F R	L.40090 L.40352	2 2	
06-07 ALL MODEL	F R	L.40090 L.40328	2 2	
<b>CIVIC HATCHBACK</b>				
90-91	F R	L.40029 L.40315	2 2	
92-93 1500 CX, DX, VX	F R	L.40049 L.40304	2 2	
92-93 1600 Si (W/O ABS)	F R	L.40049 L.40328	2 2	

# STAINLESS STEEL BRAKE LINE

MAKE/MODEL	AXLE	PART #	LINE NO.	NOTES
YEAR	F/R			
94-95 1500 CX, DX, VX	F	L.40049	2	
	R	L.40304	2	
94-95 1600 Si (W/O ABS)	F	L.40049	2	
	R	L.40328	2	
94-95 1600 Si (W/ ABS)	F	L.40039	2	
	R	L.40328	2	
96-00	F	L.40067	2	
	R	L.40304	2	
02-05 Si	F	L.40090	2	
	R	L.40350	2	
<b>CIVIC SEDAN</b>				
90-91 1500 DX, LX	F	L.40029	2	
	R	L.40315	2	
90-91 EX 1600	F	L.40042	2	
	R	L.40315	2	
92-95 DX, LX	F	L.40049	2	
	R	L.40304	2	
92-95 EX	F	L.40039	2	
	R	L.40328	2	
96-00 DX, LX, GX	F	L.40067	2	
	R	L.40304	2	
96-00 EX	F	L.40059	2	
	R	L.40304	2	
01-05 ALL MODEL	F	L.40090	2	
	R	L.40352	2	
<b>CIVIC DEL SOL</b>				
93-97 S	F	L.40049	2	
	R	L.40304	2	
93-97 Si (W/O ABS)	F	L.40049	2	
	R	L.40328	2	
93-97 V-TEC (W/ ABS)	F	L.40039	2	
	R	L.40328	2	
<b>CR-V</b>				
97-01	F	L.40061	2	
	R			
02-06	F	L.40082	2	
	R	L.40351	2	
<b>CRX (1.5L DX, HF)</b>				
84-87	F	L.40004	2	
	R	L.40304	2	
88	F	L.40023	2	
	R	L.40315	2	
89-91	F	L.40029	2	
	R	L.40315	2	
<b>CRX (1.5L, 1.6L Si)</b>				
84-88	F	L.40023	2	
	R	L.40315	2	
89	F	L.40029	2	
	R	L.40315	2	
90-91	F	L.40029	2	
	R	L.40316	2	
<b>ELEMENT</b>				
03-07	F	L.40072	2	
	R	L.40360	2	
<b>ODYSSEY</b>				
95-98	F	L.40039	2	
	R	L.40325	4	
99-01	F	L.40069	2	
	R			
02-04	F	L.40069	2	
	R	L.40325	4	
<b>PILOT</b>				
03-07	F	L.40069	2	
	R			
<b>PRELUDE</b>				
88-90 S	F	L.40034	2	
	R	L.40019	2	
88-91 Si	F	L.40021	2	



# STAINLESS STEEL BRAKE LINE

MAKE/MODEL	AXLE	PART #	LINE NO.	NOTES
YEAR	F/R			
92-96 ALL MODEL	R	L.40019	2	
	F	L.40039	2	
	R	L.40328	2	
97-01 ALL MODEL	F	L.40061	2	
	R	L.40334	2	
<b>S2000</b>				
00-05	F	L.40088	2	
	R	L.40354	2	
<b>HUMMER</b>				
<b>H2</b>				
03-07	F	L.66110	2	
	R	L.66348	2	
<b>H3</b>				
06-07	F	L.69002	2	
	R			
<b>HYUNDAI</b>				
<b>AZERA</b>				
06-07	F	L.51070	2	
	R			
<b>ELANTRA</b>				
92-96	F	L.46021	4	
	R			
97-00	F	L.51067	2	
	R			
01-06 W/ REAR DRUM	F	L.51012	2	
	R			
01-06 W/ REAR DISC	F	L.51012	2	
	R	L.51305	2	
<b>TIBURON</b>				
97-10/99	F	L.51067	2	
	R			
11/99-01 W/ REAR DISC	F	L.51067	2	
	R	L.51314	2	
03-07	F	L.51012	2	
	R	L.51305	2	
<b>INFINITI</b>				
<b>FX35, FX45</b>				
03-07	F	L.42082	2	
	R	L.42374	2	
<b>G20</b>				
91-94	F	L.42058	2	
	R	L.42327	2	
95-97	F	L.42054	2	
	R	L.42327	2	
99-02	F	L.42054	2	
	R	L.42345	2	
<b>G35</b>				
02-06	F	L.42078	2	
	R	L.42364	2	
<b>I30, I35</b>				
95-04	F	L.42058	2	
	R	L.42345	2	
<b>J30</b>				
92-97	F	L.42045	2	
	R	L.42340	2	
<b>M35, M45</b>				
06	F	L.42090	2	
	R	L.42364	2	
<b>Q45</b>				
90-96	F	L.42049	2	
	R	L.42341	2	
97-07	F	L.42045	2	
	R	L.42340	2	
<b>QX56</b>				
04-06	F	L.42086	2	

# STAINLESS STEEL BRAKE LINE

MAKE/MODEL	AXLE	PART #	LINE NO.	NOTES
YEAR	F/R			
	R			
<b>LEXUS</b>				
<b>ES 300, ES 330, ES 350</b>				
92-01	F	L.44068	2	
	R	L.44380	2	
02-07	F	L.44082	2	
	R	L.44376	2	
<b>GS 300, GS 350, GS 400, GS 430, GS 450H</b>				
93-97	F	L.44073	2	
	R	L.44365	2	
98-05	F	L.44073	2	
	R	L.44366	2	
06-07	F	L.44077	2	
	R	L.44077	2	
<b>IS 200, IS220, IS 250, IS 300, IS 350</b>				
00-05 IS 200, 300	F	L.44077	2	
	R	L.44396	2	
06-07 IS 220d, 250, 350	F	L.44077	2	
	R	L.44077	2	
<b>LS 400, LS 430</b>				
89-92	F	L.44073	2	
	R	L.44350	2	
93-00	F	L.44061	2	
	R	L.44366	2	
01-06	F	L.44078	2	
	R	L.44366	2	
<b>LX 470</b>				
98-07	F			
	R	L.44407	2	
<b>RX 300, RX 330, RX 350, RX 400H</b>				
98-03	F	L.44068	2	
	R	L.44380	2	
04-08	F	L.44082	2	
	R	L.44380	2	
<b>SC 300, SC 400, SC 430</b>				
92-00	F	L.44048	2	
	R	L.44366	2	
02-07	F	L.44073	2	
	R	L.44366	2	
<b>LINCOLN</b>				
<b>NAVIGATOR</b>				
3/18/02-06	F	L.65154	2	
	R			
<b>ZEPHYR</b>				
06	F	L.45042	2	
	R	L.45345	2	
<b>MAZDA</b>				
<b>MIATA MX-5</b>				
89-00	F	L.45022	2	
	R	L.45328	2	
01-05 NORMAL SUSPENSION	F	L.45022	2	
	R	L.45328	2	
01-05 SPORT SUSPENSION	F	L.45030	2	
	R	L.45328	2	
04-05 MAZDASPEED MX-5 TURBO	F	L.45030	2	
	R	L.45328	2	
06-07	F			
	R	L.45328	2	
<b>PROTÉGÉ</b>				
99-00 W/ REAR DRUM	F	L.45041	2	
	R	L.45315	2	
01-03 W/ REAR DRUM	F	L.45041	2	
	R	L.45315	2	
01-03 W/ REAR DISC (ALL MODEL)	F	L.45041	2	
	R	L.45340	2	

# STAINLESS STEEL BRAKE LINE

MAKE/MODEL	AXLE	PART #	LINE NO.	NOTES
YEAR	F/R			
<b>RX7</b>				
86-92 W/ SOLID REAR DISC (4 LUG)	F	L.45024	2	
	R	L.45322	2	
89-92	F	L.45015	2	
	R	L.45322	2	
93-95	F	L.45027	2	
	R	L.45334	2	
<b>RX8</b>				
04-07	F	L.45044	2	
	R	L.45336	2	
<b>3</b>				
04-07 ALL MODEL	F	L.45040	2	
	R	L.45335	2	
<b>5</b>				
06-07	F	L.45040	2	
	R			
<b>6</b>				
03-07 EXC MAZDASPEED 6	F	L.45042	2	
	R	L.45345	2	
<b>929</b>				
88-91	F	L.45016	2	
	R	L.45323	2	
<b>MERCEDES-BENZ</b>				
<b>C32 AMG (W203)</b>				
02-04	F	L.35016	2	
	R	L.35302	2	
<b>C36 AMG (W202)</b>				
95-97	F	L.35016	2	
	R	L.35302	2	
<b>C43 AMG (W202)</b>				
99-00	F	L.35016	2	
	R	L.35302	2	
<b>C55 AMG (W203)</b>				
05-07	F	L.35016	2	
	R	L.35302	2	
<b>C220, C230 (W202, W203)</b>				
94-07	F	L.35016	2	
	R	L.35302	2	
<b>C240 SEDAN, WAGON (W203)</b>				
01-05 EXC 4-MATIC AWD	F	L.35016	2	
	R	L.35302	2	
<b>C280 (W202)</b>				
94-07 EXC 4-MATIC AWD	F	L.35016	2	
	R	L.35302	2	
<b>C320, C350 SEDAN, WAGON (W203)</b>				
01-07 EXC 4-MATIC AWD	F	L.35016	2	
	R	L.35302	2	
<b>CL55, CL65 AMG (W215)</b>				
01-06	F	L.35021	2	
	R	L.35316	2	
<b>CL500, CL600 (W140, W215)</b>				
98-99 W140	F	L.35016	2	
	R	L.35302	2	
00-06 W215	F	L.35021	2	
	R	L.35316	2	
<b>CLK55 AMG, CLK63 AMG (W208, W209)</b>				
01-07	F	L.35016	2	
	R	L.35302	2	
<b>CLK320, CLK350 (W208, W209)</b>				
98-07	F	L.35016	2	
	R	L.35302	2	
<b>CLK430 (W208), CLK500, CLK550 (W209)</b>				
99-07	F	L.35016	2	
	R	L.35302	2	
<b>CLS55 AMG, CLS63 AMG (W219)</b>				
05-07	F	L.35016	2	
	R	L.35316	2	

# STAINLESS STEEL BRAKE LINE

MAKE/MODEL	AXLE	PART #	LINE NO.	NOTES
YEAR	F/R			
<b>CLS500, CLS550 (W219)</b>				
05-07	F	L.35016	2	
	R	L.35316	2	
<b>E55 AMG (W210, W211), E63 AMG (W211)</b>				
99-02 W210	F	L.35016	2	
	R	L.35302	2	
03-07 W211	F	L.35016	2	
	R	L.35316	2	
<b>E300 DIESEL, TURBODIESEL (W124, W210)</b>				
96-00	F	L.35016	2	
	R	L.35302	2	
<b>E320 COUPE, CABRIOLET, SEDAN (W124, W210, W211)</b>				
96-02	F	L.35016	2	
	R	L.35302	2	
03-07 EXC 4-MATIC AWD	F	L.35016	2	
	R	L.35316	2	
<b>E320, E350 WAGON (W124, W210, W211)</b>				
98-03 EXC 4-MATIC AWD	F	L.35016	2	
	R	L.35302	2	
04-07 EXC 4-MATIC AWD	F	L.35016	2	
	R	L.35316	2	
<b>E420, E430 (W124, W210)</b>				
94-02 EXC 4-MATIC AWD	F	L.35016	2	
	R	L.35302	2	
<b>E500, E550 (W124, W211)</b>				
03-07 EXC 4-MATIC AWD	F	L.35016	2	
	R	L.35316	2	
<b>S55 AMG, S65 AMG (W220, W221)</b>				
01-06	F	L.35016	2	
	R	L.35316	2	
<b>S320 (W140), S350 (W220), S350 TURBODIESEL (W140)</b>				
94-99 W140	F	L.35016	2	
	R	L.35302	2	
06 W220	F	L.35016	2	
	R	L.35316	2	
<b>S420, S430 (W140, W220)</b>				
94-99 W140	F	L.35016	2	
	R	L.35302	2	
00-06 W220, EXC 4-MATIC AWD	F	L.35016	2	
	R	L.35316	2	
<b>S500 (W140, W220)</b>				
94-99 W140	F	L.35016	2	
	R	L.35302	2	
00-06 W220, EXC 4-MATIC AWD	F	L.35016	2	
	R	L.35316	2	
<b>S600 (W140, W220)</b>				
94-99 W140	F	L.35016	2	
	R	L.35302	2	
01-06 W220, EXC 4-MATIC AWD	F	L.35016	2	
	R	L.35316	2	
<b>SL55 AMG, SL65 AMG (R230)</b>				
03-07	F	L.35016	2	
	R			
<b>SL320, SL500, SL550 (R129, R230)</b>				
96-02	F	L.35021	2	
	R	L.35302	2	
03-07	F	L.35016	2	
	R			
<b>SL600 (R129, R230)</b>				
94-02	F	L.35021	2	
	R	L.35302	2	
04-07	F	L.35016	2	
	R			
<b>SLK32 AMG (R170), SLK55 AMG (R171)</b>				
01-06	F	L.35016	2	
	R	L.35302	2	
<b>SLK230, SLK280, SLK320, SLK350 (R170, R171)</b>				
98-07	F	L.35016	2	

# STAINLESS STEEL BRAKE LINE

MAKE/MODEL	AXLE	PART #	LINE NO.	NOTES
YEAR	F/R			
	R	L.35302	2	
<b>MERCURY</b>				
<b>MILAN</b>				
06-07	F	L.45042	2	
	R	L.45345	2	
<b>MINI</b>				
<b>COOPER, COOPER S</b>				
02-03	F	L.34015	2	
	R	L.34312	2	
04-07	F	L.34015	2	
	R	L.34315	2	
<b>MITSUBISHI</b>				
<b>DIAMANTE</b>				
92-96	F	L.46021	4	
	R	L.46043	4	
97-04	F	L.46017	2	
	R			
<b>ECLIPSE (EXC TURBO)</b>				
4/89-93	F	L.46021	4	
	R	L.46043	4	
94-99	F	L.46056	2	W/ REAR DRUM
	R	L.46052	2	
94-99	F	L.46056	2	W/ REAR DISC
	R	L.46020	2	
00-05	F	L.46017	2	4 CYL.
	R	L.46052	2	
00-05	F	L.46017	2	V6
	R	L.46020	2	
06-07	F	L.46004	2	
	R	L.46308	2	
<b>ECLIPSE TURBO (2WD, 4WD)</b>				
4/89-93	F	L.46021	4	
	R	L.46043	4	
94-99	F	L.46056	2	
	R	L.46020	2	
<b>GALANT (EXC SIGMA)</b>				
11/89-1/93	F	L.46021	4	
	R	L.46043	4	
2/93-1/98	F	L.46056	2	W/ REAR DRUM
	R	L.46052	2	
2/93-1/98	F	L.46056	2	W/ REAR DISC
	R	L.46020	2	
2/98-03	F	L.46017	2	W/ REAR DRUM
	R	L.46052	2	
2/98-03	F	L.46017	2	W/ REAR DISC
	R	L.46020	2	
04-07	F	L.46004	2	
	R	L.46308	2	
<b>LANCER (EXC EVOLUTION)</b>				
02-06	F	L.46004	2	ALL MODEL
	R	L.46301	2	
<b>LANCER EVOLUTION AWD</b>				
03-06	F	L.46004	2	W/ BREMBO CALIPER
	R	L.46305	2	
<b>STARION</b>				
83-89	F	L.46003	4	
	R	L.46002	4	
<b>3000 GT, GT-SL</b>				
90-99	F	L.46021	4	
	R	L.46043	4	
<b>3000 GT-VR4</b>				
4/90-99	F	L.46021	4	
	R	L.46043	4	

## NISSAN

# STAINLESS STEEL BRAKE LINE

MAKE/MODEL	AXLE	PART #	LINE NO.	NOTES
YEAR	F/R			
<b>ALTIMA</b>				
93-5/97 W/ REAR DRUM	F	L.42058	2	
	R	L.42342	2	
93-5/97 W/ REAR DISC	F	L.42058	2	
	R	L.42343	2	
6/97-01 W/ REAR DRUM	F	L.42058	2	
	R	L.42355	2	
6/97-01 W/ REAR DISC	F	L.42058	2	
	R	L.42343	2	
02-06	F	L.42058	2	
	R	L.42362	2	
<b>ARMADA</b>				
04-07	F	L.42086	2	
	R			
<b>FRONTIER 2WD</b>				
5/99-01 V6	F	L.42062	2	
	R			
<b>FRONTIER 4WD</b>				
9/97-01	F	L.42062	2	
	R			
<b>MAXIMA</b>				
9/89-1/94 W/ REAR DRUM	F	L.42058	2	
	R	L.42005	2	
9/89-1/94 W/ REAR DISC	F	L.42058	2	
	R	L.42327	2	
2/94-01	F	L.42058	2	
	R	L.42345	2	
02-03	F	L.42058	2	
	R	L.42345	2	
04-07	F	L.42058	2	
	R	L.42362	2	
<b>SENTRA</b>				
91-94 W/ REAR DRUM	F	L.42041	2	
	R	L.42339	2	
91-94 W/ REAR DISC	F	L.42041	2	
	R	L.42323	2	
95-99 W/ REAR DRUM	F	L.42052	2	
	R	L.42348	2	
95-99 W/ REAR DISC	F	L.42052	2	
	R	L.42352	2	
00-06 1.8L (W/ REAR DRUM)	F	L.42058	2	
	R	L.42358	2	
00-06 2.0L, 2.5L (W/ REAR DISC)	F	L.42058	2	
	R	L.42360	2	
<b>SKYLINE (JAPAN)</b>				
2/93-8/98 R32 (BNR32, HNR32)	F	L.12276	2	
	R	L.12277	2	
5/89-7/93 R32 (HCR32)	F	L.12278	2	
	R	L.12279	2	
8/93-5/98 R33 (ECR33)	F	L.12280	2	
	R	L.12281	2	
1/95-02 R33/R34 (BCNR33, BNR34)	F	L.12274	2	
	R	L.12275	2	
<b>TITAN</b>				
04-07	F	L.42086	2	
	R	L.42378	4	
<b>XTERRA</b>				
00-01	F	L.42062	2	
	R			
<b>240SX</b>				
89-98	F	L.42058	2	
	R	L.48010	2	
<b>300ZX (TURBO, NON TURBO)</b>				
84-1/89	F	L.42013	2	
	R	L.42003	4	
2/89-96	F	L.42038	2	
	R	L.42338	2	
<b>350Z</b>				

# STAINLESS STEEL BRAKE LINE

MAKE/MODEL	AXLE	PART #	LINE NO.	NOTES
YEAR	F/R			
6/02-07 ALL MODEL	F	L.42078	2	
	R	L.42364	2	
<b>PONTIAC</b>				
<b>FIREBIRD, FORMULA, TRANS AM</b>				
98-02	F	L.62088	2	
	R			
<b>SOLSTICE</b>				
06-07	F	L.62126	2	
	R	L.62425	2	
<b>VIBE</b>				
03-07 2WD (W/ REAR DRUM)	F	L.44126	2	
	R	L.44386	2	
03-07 GT-2WD (W/ REAR DISC)	F	L.44126	2	
	R	L.44394	2	
03-07 4WD (W/ REAR DRUM)	F	L.44126	2	
	R			
<b>PORSCHE</b>				
<b>BOXSTER, BOXSTER S</b>				
97-07	F	L.37020	2	
	R	L.37020	2	
<b>CAYENNE</b>				
03-06	F	L.37021	2	
	R	L.37313	2	
<b>CAYMAN</b>				
06-07	F	L.37020	2	
	R	L.37020	2	
<b>911 CARRERA 2 (EXC TURBO &amp; TURBO LOOK, 2S)</b>				
90-93	F	L.37019	2	
	R	L.37305	2	
94 TYPE 964	F	L.37019	2	
	R	L.37305	2	
94 TYPE 993	F	L.37019	2	
	R	L.37306	2	
95-97	F	L.37019	2	
	R	L.37306	2	
98 TYPE 993	F	L.37019	2	
	R	L.37306	2	
98 TYPE 996	F	L.37020	2	
	R	L.37020	2	
99-07 TYPE 996, TYPE 997	F	L.37020	2	
	R	L.37020	2	
<b>911 CARRERA 2 (TURBO LOOK &amp; CARRERA, 2S)</b>				
96-98	F	L.37019	2	
	R	L.37306	2	
05-07	F	L.37020	2	
	R	L.37020	2	
<b>911 CARRERA 4 (EXC TURBO &amp; TURBO LOOK, 4S)</b>				
90-94	F	L.37019	2	
	R	L.37305	2	
95-98	F	L.37019	2	
	R	L.37306	2	
99-07	F	L.37020	2	
	R	L.37020	2	
<b>911 CARRERA 4 (TURBO LOOK &amp; CARRERA, 4S)</b>				
96-98	F	L.37019	2	
	R	L.37306	2	
02-07	F	L.37020	2	
	R	L.37020	2	
<b>911 GT2</b>				
03-05	F	L.37020	2	
	R	L.37020	2	
<b>911 GT3</b>				
04-07	F	L.37020	2	
	R	L.37020	2	
<b>911 TURBO</b>				
95-98	F	L.37019	2	

# STAINLESS STEEL BRAKE LINE

MAKE/MODEL YEAR	AXLE F/R	PART #	LINE NO.	NOTES
01-07	R	L.37306	2	
	F	L.37020	2	
	R	L.37020	2	
<b>928, CS, GT, GTS, S, S4</b>				
89-95	F	L.37017	2	
	R	L.37311	2	
<b>944 SERIES</b>				
89-91 TURBO, NON-TURBO	F	L.37018	2	
	R	L.37304	2	
<b>968</b>				
92-95	F	L.37018	2	
	R	L.37304	2	
<b>SAAB</b>				
<b>9-2X AWD</b>				
05-06 ALL MODEL	F	L.47026	2	
	R	L.47306	2	
<b>9000 S</b>				
90-94	F	L.38004	2	
	R	L.38302	2	
<b>9000 TURBO</b>				
88-89	F	L.38003	2	
	R	L.38302	2	
90-94	F	L.38004	2	
	R	L.38302	2	
<b>SATURN</b>				
<b>SKY</b>				
07	F	L.62126	2	
	R	L.62425	2	
<b>SCION</b>				
<b>xA, xB</b>				
04-07	F	L.44124	2	
	R	L.44372	2	
<b>tC</b>				
05-07	F	L.44126	2	
	R	L.44387	2	
<b>SUBARU</b>				
<b>BAJA</b>				
03	F	L.47026	2	
	R	L.47308	4	
04-06 SPORT, TURBO	F	L.47026	2	
	R	L.47315	4	
<b>FORESTER</b>				
98-07 ALL MODEL	F	L.47026	2	
	R	L.47306	2	
<b>IMPREZA COUPE, SEDAN (EXC WRX)</b>				
11/92-01	F	L.47014	2	
	R	L.47306	2	
02-07	F	L.47026	2	
	R	L.47306	2	
<b>IMPREZA OUTBACK</b>				
95-01	F	L.47014	2	
	R			
02-07	F	L.47026	2	
	R	L.47306	2	
<b>IMPREZA (WRX, STi)</b>				
02	F	L.47026	2	
	R	L.47306	2	
03-05 EXC STi	F	L.47026	2	
	R	L.47306	2	
03-05 STi (W BREMBO CALIPER)	F	L.47032	2	
	R	L.47306	2	
06-07 ALL MODEL	F	L.47032	2	
	R	L.47306	2	
<b>LEGACY (SEDAN)</b>				



# STAINLESS STEEL BRAKE LINE

MAKE/MODEL	AXLE	PART #	LINE NO.	NOTES
YEAR	F/R			
90-96	F	L.47014	2	
	R	L.47306	2	
97-99 GT (W REAR DISC)	F	L.47026	2	
	R	L.47306	2	
97-99 L	F	L.47014	2	
	R	L.47306	2	
00	F	L.47026	2	
	R	L.47315	4	
01 L GT	F	L.47026	2	
	R	L.47315	4	
01 GT LTD	F	L.47026	2	
	R	L.47308	4	
02-04 L L-S	F	L.47026	2	
	R	L.47315	4	
02-04 GT, GT LTD	F	L.47026	2	
	R	L.47308	4	
05-06 2.5i	F	L.47026	2	
	R	L.47315	4	
05-06 2.5 GT	F	L.47026	2	
	R	L.47308	4	
07 ALL MODEL	F	L.47026	2	
	R	L.47315	4	
<b>LEGACY (WAGON)</b>				
90-95	F	L.47014	2	
	R	L.47306	2	
96-99 EXC OUTBACK W/ REAR DISC	F	L.47014	2	
	R	L.47306	2	
96-99 OUTBACK W/ REAR DISC	F	L.47026	2	
	R	L.47306	2	
00-4/02	F	L.47026	2	
	R	L.47315	4	
5/02-04 L L-S	F	L.47026	2	
	R	L.47315	4	
5/02-04 GT	F	L.47026	2	
	R	L.47308	4	
05-06 2.5i	F	L.47026	2	
	R	L.47315	4	
05-06 2.5 GT	F	L.47026	2	
	R	L.47308	4	
07 ALL MODEL	F	L.47026	2	
	R	L.47315	4	
<b>OUTBACK</b>				
00-04	F	L.47026	2	
	R	L.47308	4	
05-07 ALL MODEL	F	L.47026	2	
	R	L.47315	4	
<b>SUZUKI</b>				
<b>SWIFT</b>				
89 GT, GTi (W REAR DISC)	F	L.48021	2	
	R	L.48315	2	
89-90 3-5 DOOR (W REAR DRUM)	F	L.48018	2	
	R	L.48313	2	
90-94 3 DOOR GA, GL	F	L.48018	2	
	R	L.48313	2	
90-94 4 DDOR	F	L.48021	2	
	R	L.48313	2	
90-94 GT, GTi	F	L.48021	2	
	R	L.48315	2	
95-96	F	L.48018	2	
	R	L.48313	2	
97-01	F	L.48021	2	
	R	L.48313	2	
<b>TOYOTA</b>				
<b>AVALON</b>				
95-04	F	L.44068	2	
	R	L.44380	2	

# STAINLESS STEEL BRAKE LINE

MAKE/MODEL	AXLE	PART #	LINE NO.	NOTES
YEAR	F/R			
05-07	F	L.44082	2	
	R	L.44376	2	
<b>CAMRY (COUPE, SEDAN)</b>				
92-01 4 CYL. (W/ REAR DRUM)	F	L.44068	2	
	R	L.44390	2	
92-01 V6, 4 CYL. (W/ REAR DISC )	F	L.44068	2	
	R	L.44380	2	
02-06 4 CYL. (W/ REAR DRUM)	F	L.44082	2	
	R	L.44390	2	
02-06 V6, 4 CYL. (W/ REAR DISC )	F	L.44082	2	
	R	L.44376	2	
<b>CELICA</b>				
86-89 GT-S, ALL TRAC TURBO	F	L.44006	2	
	R	L.44348	2	
90-91 GT	F	L.44050	2	
	R	L.44356	2	
90-93 ALL TRAC TURBO	F	L.44050	2	
	R	L.44355	2	
90-93 GT-S	F	L.44050	2	
	R	L.44338	2	
90-93 ST	F	L.44050	2	
	R	L.44356	2	
92-93 GT	F	L.44050	2	
	R	L.44338	2	
94-97 GT	F	L.44066	2	
	R	L.44367	2	
94-97 ST	F	L.44066	2	
	R	L.44368	2	
98-99 GT, ST	F	L.44066	2	
	R	L.44367	2	
00-05 GT	F	L.44126	2	
	R			
00-05 GTS	F	L.44126	2	
	R	L.44387	2	
<b>COROLLA</b>				
85 COUPE GT-S	F	L.44004	4	
	R	L.44334	2	
86-87 COUPE GT-S	F	L.44030	2	
	R	L.44334	2	
88-91 COUPE GT-S	F	L.44041	2	
	R	L.44332	2	
98-02 W/ REAR DRUM	F	L.44051	2	
	R	L.44372	2	
03-04	F	L.44126	2	
	R	L.44386	2	
05-06 W/ REAR DRUM	F	L.44126	2	
	R	L.44386	2	
05-06 W/ REAR DISC	F	L.44126	2	
	R	L.44417	2	
07 W/ REAR DRUM	F	L.44126	2	
	R	L.44386	2	
<b>ECHO</b>				
00-05 W/ REAR DRUM	F	L.44124	2	
	R	L.44372	2	
<b>FJ CRUISER</b>				
07	F	L.44362	2	
	R			
<b>HIGHLANDER</b>				
01-07	F	L.44082	2	
	R	L.44380	2	
<b>MATRIX</b>				
03-07 XR	F	L.44126	2	
	R	L.44386	2	
03-07 XRS	F	L.44126	2	
	R	L.44394	2	
<b>MR 2, MRS SPYDER</b>				
85-89	F	L.44044	2	
	R	L.44335	2	

# STAINLESS STEEL BRAKE LINE

MAKE/MODEL	AXLE	PART #	LINE NO.	NOTES
YEAR	F/R			
90-95 ALL MODEL	F	L.44053	2	
	R	L.44361	2	A
00-05	F	L.44122	2	
	R	L.44122	2	
<b>LANDCRUISER</b>				
98-07	F			
	R	L.44407	2	
<b>PRIUS</b>				
04-07	F	L.44126	2	
	R	L.44386	2	
<b>RAV 4</b>				
96-03 EV (W/ REAR DRUM)	F	L.44070	2	
	R	L.44372	2	
01-05 EXC EV (W/ REAR DRUM)	F	L.44118	2	
	R	L.44372	2	
04-05 W/ REAR DRUM (CANADA)	F	L.44118	2	
	R	L.44412	2	
04-05 W/ REAR DISC (USA)	F	L.44118	2	
	R	L.44372	2	
<b>SEQUOIA</b>				
01-07	F	L.44362	2	
	R			
<b>SOLARA</b>				
99-03 4 CYL. (W/ REAR DRUM)	F	L.44068	2	
	R	L.44390	2	
99-03 6 CYL., 4 CYL. (W/ REAR DISC)	F	L.44068	2	
	R	L.44380	2	
04-07	F	L.44082	2	
	R	L.44376	2	
<b>SUPRA</b>				
82-85	F	L.44012	4	
	R	L.44311	4	
86-92	F	L.44038	2	
	R	L.44345	2	
5/93-98 ALL MODEL	F	L.44048	2	
	R	L.44366	2	
<b>TACOMA</b>				
05-07 2WD X-RUNNER (5 LUG)	F	L.44086	2	
	R			
<b>TUNDRA</b>				
00-06	F	L.44362	2	
	R			
<b>YARIS</b>				
07	F	L.44132	2	
	R			
<b>4 RUNNER</b>				
11/95-07	F	L.44362	2	
	R			
<b>VOLKSWAGEN</b>				
<b>CABRIO, CABRIOLET</b>				
84-93	F	L.33001	2	
	R	L.33320A	2	
94-98	F	L.33025	2	
	R	L.33342A	2	
99-02	F	L.33025	2	
	R	L.33342	4	
<b>CORRADO</b>				
89-91 1.8L	F	L.33024	2	
	R	L.33320	4	
92-95 2.8L	F	L.33025	2	
	R	L.33342	4	
<b>EOS</b>				
07	F	L.33050	2	
	R			
<b>GOLF GL, GLS, III, LE (EXC GLS, 1.8 TURBO)</b>				
3/89-92	F	L.33001	2	
	R	L.33320A	2	

# STAINLESS STEEL BRAKE LINE

MAKE/MODEL	AXLE	PART #	LINE NO.	NOTES
YEAR	F/R			
93-11/98 W/ REAR DRUM	F	L.33025	2	
	R	L.33342A	2	
93-11/98 W/ REAR DISC	F	L.33025	2	
	R	L.33342	4	
12/98-06	F	L.33035	2	
	R	L.33349	2	B
<b>GOLF GTi, GLS TURBO, GLX (VR6), 1.8 TURBO, VR6</b>				
8/89-92 8 VALVE	F	L.33001	2	
	R	L.33320A	2	
8/89-92 16 VALVE	F	L.33001	2	
	R	L.33320	4	
95	F	L.33025	2	
	R	L.33342	4	
96-11/98 VR6	F	L.33037	2	
	R	L.33342	4	
96-11/98 2.0L (4 CYL.)	F	L.33025	2	
	R	L.33342	4	
12/98-05	F	L.33035	2	
	R	L.33349	2	B
06-07	F	L.33050	2	
	R	L.33369	2	
<b>GOLF R32 (AWD)</b>				
04	F	L.33048	2	
	R	L.33349	2	B
<b>JETTA (EXC JETTA WAGON)</b>				
90-92 W/ REAR DRUM	F	L.33001	2	
	R	L.33320A	2	
90-92 W/ REAR DISC	F	L.33030	2	
	R	L.33320	4	
93 W/ REAR DRUM	F	L.33025	2	
	R	L.33342	4	
93 W/ REAR DISC	F	L.33025	2	
	R	L.33320	4	
94-95 W/ REAR DRUM	F	L.33025	2	
	R	L.33342	4	
94-95 W/ REAR DISC	F	L.33025	2	
	R	L.33320	4	
94-95 VR6	F	L.33025	2	
	R	L.33342A	2	
96-9/98 1.8L, 1.9L, 2.0L, TDI (W/ REAR DRUM)	F	L.33025	2	
	R	L.33342A	2	
96-9/98 2.0L (W/ REAR DISC)	F	L.33025	2	
	R	L.33342	4	
96-9/98 VR6	F	L.33037	2	
	R	L.33342A	2	
10/98-04	F	L.33035	2	
	R	L.33349	2	B
05-06	F	L.33050	2	
	R	L.33369	2	
07 CITY (2.0L GAS), CANADA	F	L.33035	2	
	R	L.33349	2	B
07 TDI & 2.5L (5 CYL.) GLI & 2.0L (TURBO)	F	L.33050	2	
	R	L.33369	2	
<b>JETTA WAGON</b>				
01-05	F	L.33035	2	
	R	L.33349	2	B
<b>NEW BEETLE</b>				
98-07	F	L.33035	2	
	R	L.33349	2	B
<b>NEW BEETLE (CONVERTIBLE)</b>				
03-07	F	L.33035	2	
	R	L.33349	2	B
<b>PASAT (EXC SYNCRO)</b>				
90-94 GL, GLX	F	L.33024	2	
	R	L.33331	4	
95 GLS, GLX (VR6)	F	L.33024	2	
	R	L.33320	4	
96-97 TDI (W/ REAR DRUM) CANADA ONLY	F	L.33024	2	

# STAINLESS STEEL BRAKE LINE

MAKE/MODEL		AXLE	PART #	LINE NO.	NOTES
YEAR		F/R			
96-97	GLS, GLX (W/ REAR DISC) USA ONLY	R	L.33320A	2	
		F	L.33034	2	
		R	L.33320	4	
96-97	GLX (VR6)	F	L.33034	2	
		R	L.33320	4	
98-12/98		F	L.37020	2	
		R	L.33343	4	
12/98-01	4-MOTION AWD	F	L.37020	2	
		R	L.33347	2	
12/98-01	FWD	F	L.37020	2	
		R	L.33343	4	
02-05	4-MOTION AWD	F	L.37020	2	
		R	L.33347	2	
02-05	FWD	F	L.37020	2	
		R	L.33343	4	
02-05	W8 (4 PAD FRONT CALIPER)	F	L.33032	2	
		R			
06-07		F			
		R	L.33369	2	
<b>RABBIT</b>					
07		F	L.33050	2	
		R	L.33369	2	
<b>TOUAREG</b>					
04-07		F	L.37021	2	
		R	L.37313	2	
<b>VOLVO</b>					
<b>C30</b>					
07		F	L.39013	2	
		R	L.45335	2	
<b>C70</b>					
98-02	W/ 15" WHEEL	F	L.39005	2	
		R	L.33321A	2	
98-02	W/ 16" WHEEL	F	L.39007	2	
		R	L.33321A	2	
03-04		F	L.39007	2	
		R			
06-07		F	L.39013	2	
		R	L.45335	2	
<b>S40</b>					
00-04		F	L.39008	2	
		R	L.39316	2	
05-07		F	L.39013	2	
		R	L.45335	2	
<b>S60</b>					
01-03		F	L.39009	2	
		R	L.39317	2	
04-07	EXC R	F	L.39009	2	
		R	L.39317	2	
04-07	R (W/ BREMBO CALIPER)	F	L.39007	2	
		R	L.35302	2	
<b>S70</b>					
98	W/ 15" WHEEL	F	L.39005	2	
		R	L.33321A	2	
98	W/ 16" WHEEL	F	L.39007	2	
		R	L.33321A	2	
99-00	2WD (W/ 15" WHEEL)	F	L.39005	2	
		R	L.33321A	2	
99-00	2WD (W/ 16" WHEEL)	F	L.39007	2	
		R	L.33321A	2	
99-00	AWD	F	L.39005	2	
		R			
<b>S80</b>					
99-04		F	L.39009	2	
		R			
<b>V40</b>					
00-04		F	L.39008	2	
		R	L.39316	2	

# STAINLESS STEEL BRAKE LINE

MAKE/MODEL	AXLE	PART #	LINE NO.	NOTES
YEAR	F/R			
<b>V50</b>				
05-07	F	L.39013	2	
	R	L.45335	2	
<b>V70, V70 R (EXC XC)</b>				
98-00 W/ 15" WHEEL, 280MM FRONT DISC (2WD)	F	L.39005	2	
	R	L.33321A	2	
98-00 W/ 16" WHEEL, 302MM FRONT DISC (2WD)	F	L.39007	2	
	R	L.33321A	2	
98-00 AWD & R	F	L.39005	2	
	R			
01-03 ALL MODEL	F	L.39009	2	
	R	L.39317	2	
04-07 EXC R	F	L.39009	2	
	R	L.39317	2	
04-07 R	F	L.39007	2	
	R	L.35302	2	
<b>V70 XC AWD</b>				
98-00	F	L.39005	2	
	R			
01-02	F	L.39005	2	
	R	L.39317	2	
<b>XC90</b>				
03-06	F	L.39011	2	
	R	L.39317	2	
<b>740, 760, 780 SERIES</b>				
88-93	F	L.39005	2	
	R			
<b>850 SERIES</b>				
93-97	F	L.39005	2	
	R	L.33321A	2	
<b>940 SERIES</b>				
91-97	F	L.39005	2	
	R			

**NOTES:**

A=SPECIAL ORDER (LEAD TIME 7-10 DAYS DEPENDING ON APPLICATION)

B=UPPER LINES ONLY: LOWER LINES NOT AVAILABLE

**GENERAL INFORMATION:**

ALL PRICES ARE PER AXLE LINE KIT SET

ALL KITS INCLUDE ALL NECESSARY HARDWARE

UNLESS OTHERWISE SPECIFIED, ALL BRAKE LINES ARE FOR NORTH AMERICAN VEHICLES

## AERO PART

TYPE	DESCRIPTION	PART #	NOTES
<b>GT WING: DRY CARBON</b>			
3-D2 GT WING	145X24CM, 100% DRY-CARBON, 3K 1X2 TWILL	BA2-57L05	
3-D2 GT WING	160X24CM, 100% DRY-CARBON, 3K 1X2 TWILL	BA2-63L05	
<b>GT WING: DRY KEVLAR</b>			
3-D3 GT WING	145X24CM, 100% DRY-KEVLAR, 3K 1X2 TWILL, YELLOW	BA3-57L05	A
3-D3 GT WING	160X24CM, 100% DRY-KEVLAR, 3K 1X2 TWILL, YELLOW	BA3-63L05	A
<b>GT WING: COMPONENTS</b>			
LOW RUDDER	20X10CM, ANODIZED BLACK	ST-057L	
MEDIUM RUDDER	25X10CM, ANODIZED BLACK	ST-057M	
HIGH RUDDER	30X10CM, ANODIZED BLACK	ST-057H	
DRY CARBON RUDDER	30X10CM	DC-057H	
DRY KEVLAR RUDDER	30X10CM	DK-057H	
CARBON SIDE WING 1	100% DRY-CARBON, 3K 1X2 TWILL	SW-014	
CARBON SIDE WING 2	100% DRY-CARBON, 3K 1X2 TWILL	SW-005	
CARBON SIDE WING 3	100% DRY-CARBON, 3K 1X2 TWILL	SW-024	
KEVLAR SIDE WING 1	100% DRY-KEVLAR, 3K 1X2 TWILL, YELLOW	SWK-005	A
KEVLAR SIDE WING 2	100% DRY-KEVLAR, 3K 1X2 TWILL, YELLOW	SWK-024	A
ASSEMBLY KIT	U-BRACKETS, NUTS, SCREWS	UW-001	
<b>WIDEBODY AERO KIT</b>			
NISSAN 240SX (SILVIA S15)	FRONT WIDEBODY FENDER; PER SET	AK-FF	A
NISSAN 240SX (SILVIA RPS13)	SIDE STEP; PER SET	AK-SS	A
NISSAN 240SX (SILVIA RPS13)	REAR WIDEBODY FENDER; PER SET	AK-RF	A

### NOTES:

A=SPECIAL ORDER (PLEASE CALL FOR AVAILABILITY)

### GENERAL INFORMATION:

ASSEMBLY KITS INCLUDED FOR ALL PRODUCTS

### STANDARD DRY CARBON/KEVLAR WING COMPONENTS:

ONE DRY CARBON OR DRY KEVLAR FIBER WING

TWO ANODIZED BLACK ALUMINUM ALLOY RUDDERS

TWO CARBON OR KEVLAR SIDE WINGS

FOUR U-BRACKETS

# MISCELLANEOUS

TYPE	DESCRIPTION	PART #	NOTES
<b>PROMOTIONAL</b>			
SINGLE SIDE UPRIGHT (BLACK) DISPLAY. RED OR METALLIC BLUE CALIPER COLOR & DISC TYPE OF YOUR CHOICE.			
DISPLAY STAND	BLACK; DISPLAY STAND ONLY; (FC6, FC8, FC12 CALIPER SERIES)	PR.A.110	
DISPLAY STAND	BLACK; DISPLAY STAND ONLY; (FC2, FC4, FM4, FM6 CALIPER SERIES)	PR.A.111	
DISPLAY STAND: BRAKE SYSTEM	2-PISTON CALIPER (FC2); H2 CERAMIC PAD; STAINLESS LINE; 2-PIECE SYSTEM 330MM DISC	PR.B.110	
DISPLAY STAND: BRAKE SYSTEM	4-PISTON CALIPER (FF4); H2 CERAMIC PAD; STAINLESS LINE; 2-PIECE SYSTEM 330MM DISC	PR.B.120	
DISPLAY STAND: BRAKE SYSTEM	4-PISTON CALIPER (FC4); H2 CERAMIC PAD; STAINLESS LINE; 1-PIECE SYSTEM 330MM DISC	PR.B.130	
DISPLAY STAND: BRAKE SYSTEM	4-PISTON CALIPER (FC4); H2 CERAMIC PAD; STAINLESS LINE; 2-PIECE SYSTEM 330MM DISC	PR.B.140	
DISPLAY STAND: BRAKE SYSTEM	4-PISTON CALIPER (FC4); H2 CERAMIC PAD; STAINLESS LINE; 2-PIECE SYSTEM 355MM DISC	PR.B.150	
DISPLAY STAND: BRAKE SYSTEM	4-PISTON CALIPER (FF4); H2 CERAMIC PAD; STAINLESS LINE; 2-PIECE SYSTEM 380MM DISC	PR.B.160	
DISPLAY STAND: BRAKE SYSTEM	6-PISTON CALIPER (FM6); H2 CERAMIC PAD; STAINLESS LINE; 2-PIECE SYSTEM DISC	PR.B.170	
DISPLAY STAND: BRAKE SYSTEM	6-PISTON CALIPER (FC6); H2 CERAMIC PAD; STAINLESS LINE; 2-PIECE SYSTEM 330MM DISC	PR.B.180	
DISPLAY STAND: BRAKE SYSTEM	6-PISTON CALIPER (FC6); H2 CERAMIC PAD; STAINLESS LINE; 2-PIECE SYSTEM 355MM DISC	PR.B.190	
DISPLAY STAND: BRAKE SYSTEM	8-PISTON CALIPER (FC8); H2 CERAMIC PAD; STAINLESS LINE; 2-PIECE SYSTEM 380MM DISC	PR.B.200	
DISPLAY STAND: BRAKE SYSTEM	8-PISTON CALIPER (FC8); H2 CERAMIC PAD; STAINLESS LINE; 2-PIECE SYSTEM 405MM DISC	PR.B.210	
DISPLAY STAND: BRAKE SYSTEM	12-PISTON CALIPER (FC12); H2 CERAMIC PAD; STAINLESS LINE; 2-PIECE SYSTEM 380MM DISC	PR.B.220	
DISPLAY STAND: BRAKE SYSTEM	12-PISTON CALIPER (FC12); H2 CERAMIC PAD; STAINLESS LINE; 2-PIECE SYSTEM 405MM DISC	PR.B.230	
DISPLAY STAND: CALIPER KIT	2-PISTON CALIPER (FC2); H2 CERAMIC PAD; STAINLESS LINE; ROTORA DIRECT OEM DISC	PR.C.110	
DISPLAY STAND: CALIPER KIT	4-PISTON CALIPER (FM4); H2 CERAMIC PAD; STAINLESS LINE; ROTORA DIRECT OEM DISC	PR.C.120	
DISPLAY STAND: CALIPER KIT	4-PISTON CALIPER (FC4); H2 CERAMIC PAD; STAINLESS LINE; ROTORA DIRECT OEM DISC	PR.C.130	
BRAKE GUIDE	2008 CATALOG	PR.A.120	
ROTORA BANNER/FLAG	60X180CM; BLUE	PR.A.130	
FLAG POLE	WHITE	PR.A.140	
<b>ORIGINAL WEAR</b>			
T-SHIRT	CIRCUIT BRAKER (SIZE: S); BLUE/ORANGE	TS001S	
T-SHIRT	CIRCUIT BRAKER (SIZE: M); BLUE/ORANGE	TS001M	
T-SHIRT	CIRCUIT BRAKER (SIZE: L); BLUE/ORANGE	TS001L	
T-SHIRT	CIRCUIT BRAKER (SIZE: XL); BLUE/ORANGE	TS001XL	
T-SHIRT	CIRCUIT BRAKER (SIZE: XXL); BLUE/ORANGE	TS001XXL	
T-SHIRT	TEAM ROTORA: "BRAKING IT SIDEWAYS" (SIZE: S); BLUE/ORANGE	TS002S	
T-SHIRT	TEAM ROTORA: "BRAKING IT SIDEWAYS" (SIZE: M); BLUE/ORANGE	TS002M	
T-SHIRT	TEAM ROTORA: "BRAKING IT SIDEWAYS" (SIZE: L); BLUE/ORANGE	TS002L	
T-SHIRT	TEAM ROTORA: "BRAKING IT SIDEWAYS" (SIZE: XL); BLUE/ORANGE	TS002XL	
T-SHIRT	TEAM ROTORA: "BRAKING IT SIDEWAYS" (SIZE: XXL); BLUE/ORANGE	TS002XXL	
POLO SHIRT	(SIZE: S); BLUE	TS003S	



## MISCELLANEOUS

TYPE	DESCRIPTION	PART #	NOTES
POLO SHIRT	(SIZE: M); BLUE	TS003M	
POLO SHIRT	(SIZE: L); BLUE	TS003L	
POLO SHIRT	(SIZE: XL); BLUE	TS003XL	
POLO SHIRT	(SIZE: XXL); BLUE	TS003XXL	
CAP	CIRCUIT BRAKER (BLUE)	W0001	
LANYARD	BADGE & CELL PHONE (BLUE/ORANGE-SILVER METALLIC) 1" DETACHABLE	W0002	
RACING PATCH	EMBROIDERY (1.5"X6"); ORANGE	W0003	
<b>ORIGINAL GOODS</b>			
PLAYING CARDS	POKER CARDS (2.5"X3.5")	G0001	
PAPERWEIGHT	ROTORA 4" BRAKE DISC	G0002	
<b>ORIGINAL TOYS</b>			
TOY MODEL	ROTORA WHITE NISSAN SILVIA RPS13 (SCALE 1:18); JADA TOYS	T0001	
TOY MODEL	ROTORA SUBARU WRX STI (SCALE 1:18); JADA TOYS	T0002	
TOY MODEL	ROTORA BLUE MAZDA RX8 (SCALE 1:50); HOTWHEELS	T0003	
TOY MODEL	ROTORA MAZDA RX8 RC CAR (SCALE 1:10); JADA TOYS	T0004	
TOY MODEL	ROTORA YELLOW NISSAN 350Z FAIRLADY (SCALE 1:64); HOTWHEELS	T0005	
TOY MODEL	ROTORA BLACK NISSAN 350Z FAIRLADY (SCALE 1:64); HOTWHEELS	T0006	
<b>ORIGINAL VINYL (STICKER)</b>			
ROTORA VINYL	BLACK (1.5"X7")	D0001	
ROTORA VINYL	BLUE (1.5"X7")	D0002	
ROTORA VINYL	3-D HOLOGRAM (1.5"X7")	D0003	
ROTORA VINYL	CHROME (1.5"X7")	D0004	
ROTORA VINYL	ORANGE (1.5"X7")	D0005	
ROTORA VINYL	RED (1.5"X7")	D0006	
ROTORA VINYL	WHITE (1.5"X7")	D0007	
ROTORA VINYL	YELLOW (1.5"X7")	D0008	
ROTORA VINYL	BLACK (2"X11")	D0009	
ROTORA VINYL	BLUE (2"X11")	D0010	
ROTORA VINYL	3-D HOLOGRAM (2"X11")	D0011	
ROTORA VINYL	CHROME (2"X11")	D0012	
ROTORA VINYL	ORANGE (2"X11")	D0013	
ROTORA VINYL	RED (2"X11")	D0014	
ROTORA VINYL	WHITE (2"X11")	D0015	
ROTORA VINYL	YELLOW (2"X11")	D0016	

## MISCELLANEOUS

TYPE	DESCRIPTION	PART #	NOTES
ROTORA WINDSHIELD VINYL	CIRCUIT BRAKER, WHITE OR SILVER	D0017	
<b>PERFORMANCE 2NR</b>			
BLOW-OFF VALVE	8.6-25 PSI	BV001	
FUEL PRESSURE CONTROLLER	UP TO 125 PSI	FPC01	
SHIFT KNOB CARBON FIBER	100% CARBON FIBER	CF001	
SHIFT KNOB STAINLESS STEEL	100% STAINLESS STEEL	SS001	
STEERING WHEEL EXTENDER	ANODIZED BLACK ONLY	SWE01	
<b>STRUT TOWER BARS</b>			
BMW	3 SERIES FRONT (E36)	B0001	
BMW	3 SERIES REAR (E36)	B0002	
BMW	3 SERIES FRONT E46 (EXC 02 M3'S AND ALL Z3'S)	B0003	
BMW	3 SERIES REAR E46 (EXC 02 M3'S AND ALL Z3'S)	B0004	
NISSAN	350Z (DRY-CARBON, 3K 1X2 TWILL)	B0005	

# WHEEL CLEARANCE CHART

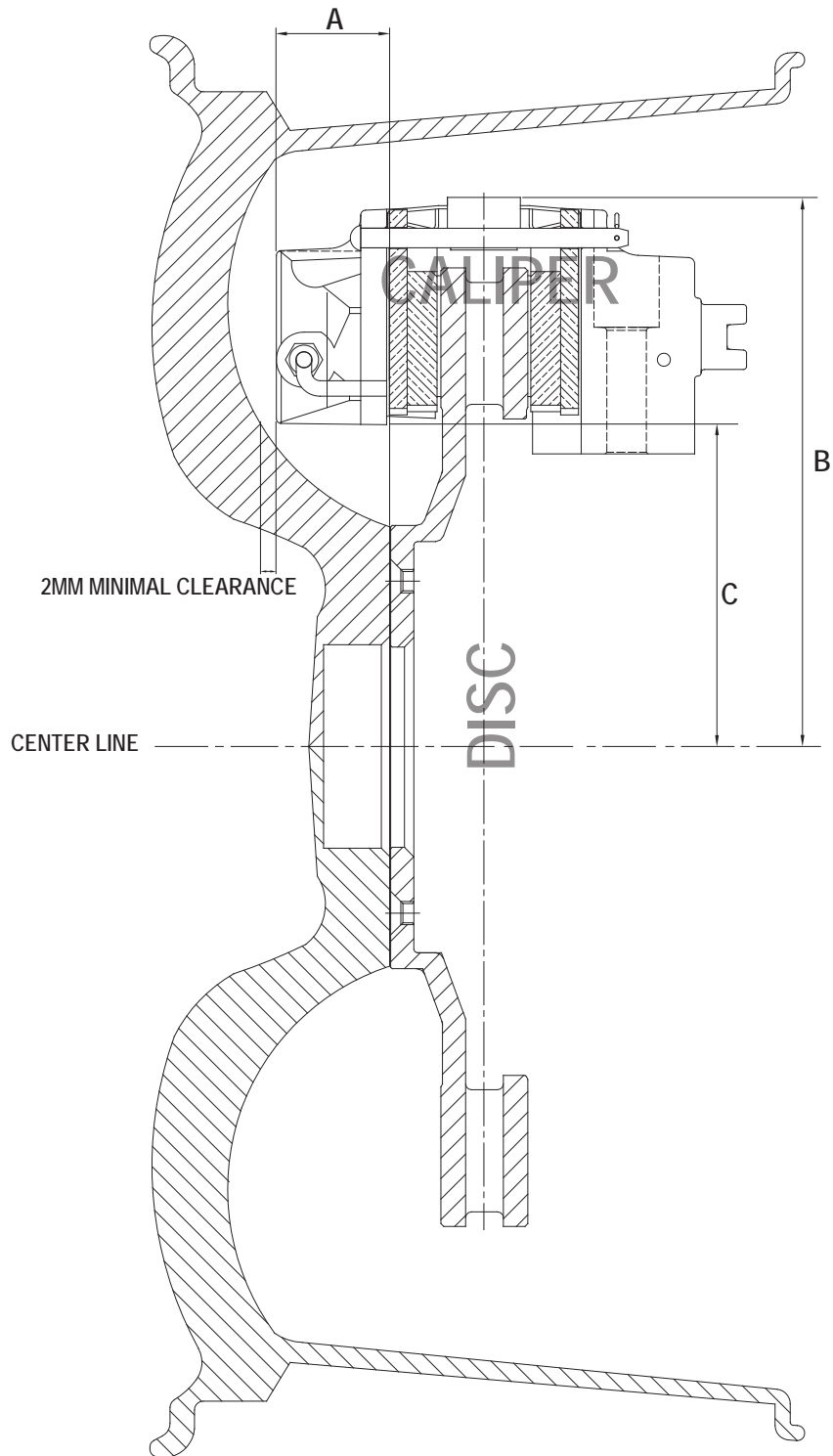

NOTE:  
ROTORA RECOMMENDS A MINIMUM OF 2MM OF ADDITIONAL CLEARANCE BETWEEN THE OUTER FACE OF THE CALIPER TO THE INNER SPOKE OF THE WHEEL.

\_COMPANY

\_BRAKE SYSTEM

\_CALIPER KIT

\_BRAKE PAD

\_BRAKE DISC

\_BRAKE LINE

**AUTHORIZED DISTRIBUTOR:**

ROTORA INC.  
13517 BENSON AVE. CHINO, CA. 91710 USA  
TEL: +1(909).590.1712 FAX: +1(909).465.6328  
EMAIL: [info@rotora.com](mailto:info@rotora.com)  
URL: <http://www.rotora.com>