







Model	Year	MG	SG	Illustration	Restrictions	Update	11:34	05.11.2005		ETKA	
PA	92	2	60	59-00		450					

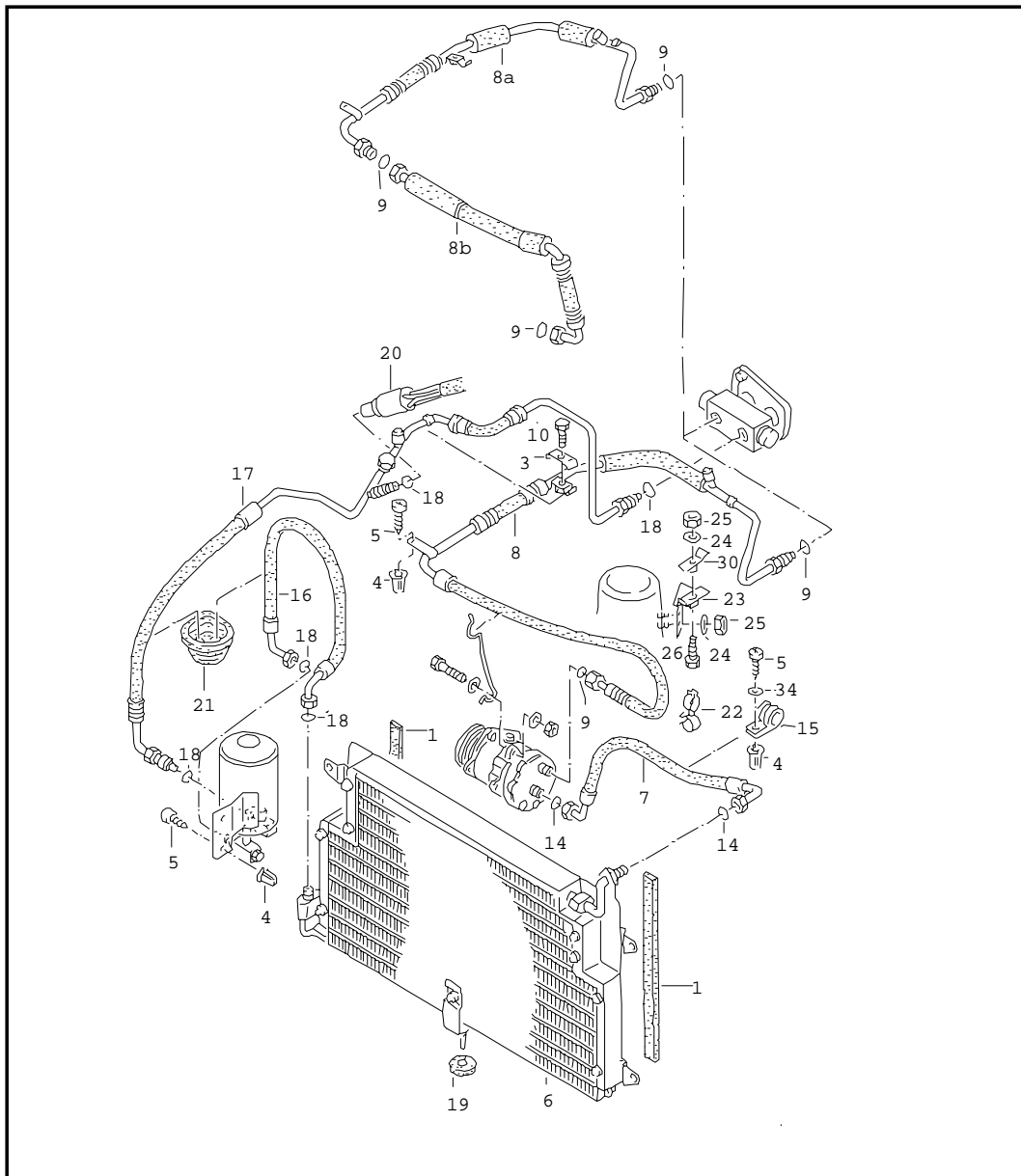

Pos	Part Number	Name	Remarks	Qty	Model
		refrigerant condenser fluid container with connecting parts			KR, ABS, 2E, 9A AAA diesel eng.: AAZ
		F >> 31-NE400 000	R12		
		F >> 31-NB400 000			
1	321 819 017	gasket	680X8X10	2	
(2)	357 820 191 A	drier	for refrigerant:	1	AAA diesel eng.: AAZ
			R12		
(2)	357 820 191 C	drier	for refrigerant:	1	
			R12 / R134A		
-	357 820 794	conversion cfc-free air conditioner	RETROFIT-KIT	1	
3	357 820 255 A	dual clip		1	lhd
4	811 807 577 C	insert nut		4	
5	N 014 098 6	oval hd. csk. self-tapp. screw	B4, 8X16	4	
6	357 820 413 A	refrigerant condenser		1	KR, ABS, 2E, 9A
		F >> 31-NE147 098*		1	AAA
		F >> 31-NB090 401*			
(6)	357 820 413 B	refrigerant condenser		1	diesel eng.: AAZ
		F 31-NE147 099>>*		1	AAA
		F 31-NB090 402>>*			
-	034 133 335	cap		1	
7	357 820 721 A	refrigerant hose (refrigerant compressor > refrigerant condenser)		1	KR, 2E, 9A, ABS
(7)	357 820 721 F	refrigerant hose (refrigerant compressor > refrigerant condenser)		1	AAA
		F >> 31-NE147 098*	lhd		
		F >> 31-NB090 401*			
(7)	357 820 721 H	refrigerant hose (refrigerant compressor > refrigerant condenser)		1	AAA
		F 31-NE147 099>>*	lhd		
		F 31-NB090 402>>*			
(7)	357 820 721 K	refrigerant hose (refrigerant compressor > refrigerant condenser)		1	diesel eng.: AAZ

Model	Year	MG	SG	Illustration	Restrictions	Update	11:34	05.11.2005		ETKA	
PA	92	2	60	59-00		450					

Pos	Part Number	Name	Remarks	Qty	Model	Pos	Part Number	Name	Remarks	Qty	Model
8	357 820 743 G	refrigerant hose (expansion valve > refrigerant compressor)	lhd	1	KR,2E,9A,ABS	(17)	357 820 741 A	refrigerant hose (fluid container > expansion valve)	lhd	1	
(8)	357 820 743 H	refrigerant hose (expansion valve > refrigerant compressor)						F >> 31-NE147 098* F >> 31-NB090 401*	lhd	1	AAA
(8)	357 820 743 N	refrigerant hose (expansion valve > refrigerant compressor)				(17)	357 820 741 C	refrigerant hose (fluid container > expansion valve)	lhd	1	AAA
		F >> 31-NE147 098* F >> 31-NB090 401*	lhd	1	AAA	-	N 904 151 02	allen key head bolt (combi) refrigerant compressor	10X32	1	AAA
(8)	358 820 743 D	refrigerant hose (expansion valve > refrigerant compressor)	rhhd	1	KR,9A,ABS,	-	N 102 278 03	allen key head bolt (combi) evaporator	M6X20	1	AAA
(8)	358 820 743 B	refrigerant hose (expansion valve > refrigerant compressor)	rhhd front, lower	1	2E	(17)	357 820 741 B	refrigerant hose (fluid container > expansion valve)	lhd	1	diesel eng.: AAZ
8A	357 820 743 L	refrigerant hose (expansion valve > refrigerant compressor)	lhd	1	diesel eng.: AAZ	(17)	358 820 741 A	refrigerant hose (fluid container > expansion valve)	rhhd front, lower	1	KR,2E,9A,ABS
8B	357 820 744 C	refrigerant hose (expansion valve > refrigerant compressor)	lhd	1	diesel eng.: AAZ	(17)	358 820 742	refrigerant hose (fluid container > expansion valve)	rhhd rear, upper	1	KR,2E,9A,ABS
9	803 260 749 B	round seal		2		(17)	358 820 742 A	refrigerant hose (fluid container > expansion valve)	rhhd rear, upper	1	AAA
-	1H0 820 749	seal	20,35	1	AAA						
10	N 010 215 27	hexagonal head bolt	M6X15	1		18	803 260 749	round seal	8MM	5	
14	803 260 749 A	round seal		2		19	171 121 276 D	rubber washer		1	
15	N 020 647 1	pipe clip	D1-24X15	1		20	357 959 139 B	high-low pressure and fan switch		1	KR,ABS,2E,9A
(15)	N 020 690 1	pipe clip	B20X28GI	1		(20)	357 959 139 C	high-low pressure and fan switch		1	AAA diesel eng.: AAZ
16	357 820 739	refrigerant hose (refirgerant condensor > fluid container)		1	KR,2E,9A,ABS	21	357 820 751	grommet		1	
(16)	357 820 739 A	refrigerant hose (refirgerant condensor > fluid container)		1	AAA diesel eng.: AAZ	(22)	4A0 820 199	double cable tie	10,5/27MM	1	
17	357 820 741	refrigerant hose (fluid container > expansion valve)	lhd	1	KR,2E,9A,ABS	(22)	191 820 755 A	bracket for hose	39/21MM	1	
						(22)	191 820 755 B	bracket for hose	39/27MM	1	
						22	357 820 755	bracket for hose	27/21	1	
						(22)	357 820 755 A	bracket for hose	10,5/39MM	1	

Model	Year	MG	SG	Illustration	Restrictions	Update	11:34	05.11.2005		ETKA	
PA	92	2	60	59-00		450					

Pos	Part Number	Name	Remarks	Qty	Model	Pos	Part Number	Name	Remarks	Qty	Model
(23)	357 820 789	bracket for refrigerant hose bracket, upper part	lhd	1	AAA						
(23)	357 820 787	bracket, lower part	lhd	1	AAA						
(23)	357 820 769 G	retainer refrigerant hose lock carrier	lhd	1	AAA						
(23)	357 820 769 E	retainer refrigerant hose	lhd	1							
(23)	357 820 769 C	retainer refrigerant hose air guide		1							
(23)	358 820 769	bracket for refrigerant hose (fluid container > expansion valve)	rhd	1							
(23)	358 820 769 C	bracket for refrigerant hose air guide	rhd	1							
-	N 011 664 4	washer	B4,3X12X1 rhd	3							
-	N 014 106 3	oval hd. csk. self-tapp. screw	ST4,8X22-C rhd	3							
24	N 011 524 23	washer	A6,4X12,5X1,6	2							
25	N 011 006 24	hexagonal nut	M6	2							
26	N 010 218 6	hexagonal head bolt	M6X25	1							
30	357 820 775 A	dual clip	lhd	1	AAA						
(30)	N 020 690 1	pipe clip	B20X28GI rhd	1							
(30)	N 020 640 2	pipe clip	D1-18X15 rhd	1							
34	N 011 524 23	washer	A6,4X12,5X1,6 rhd	2							
		- - - E N D - - -									