







Model	Year	MG	SG	Illustration	VIN No.	Update	19:12	18.02.20100		ETKA	
PA	90	9	03	161-00		336					



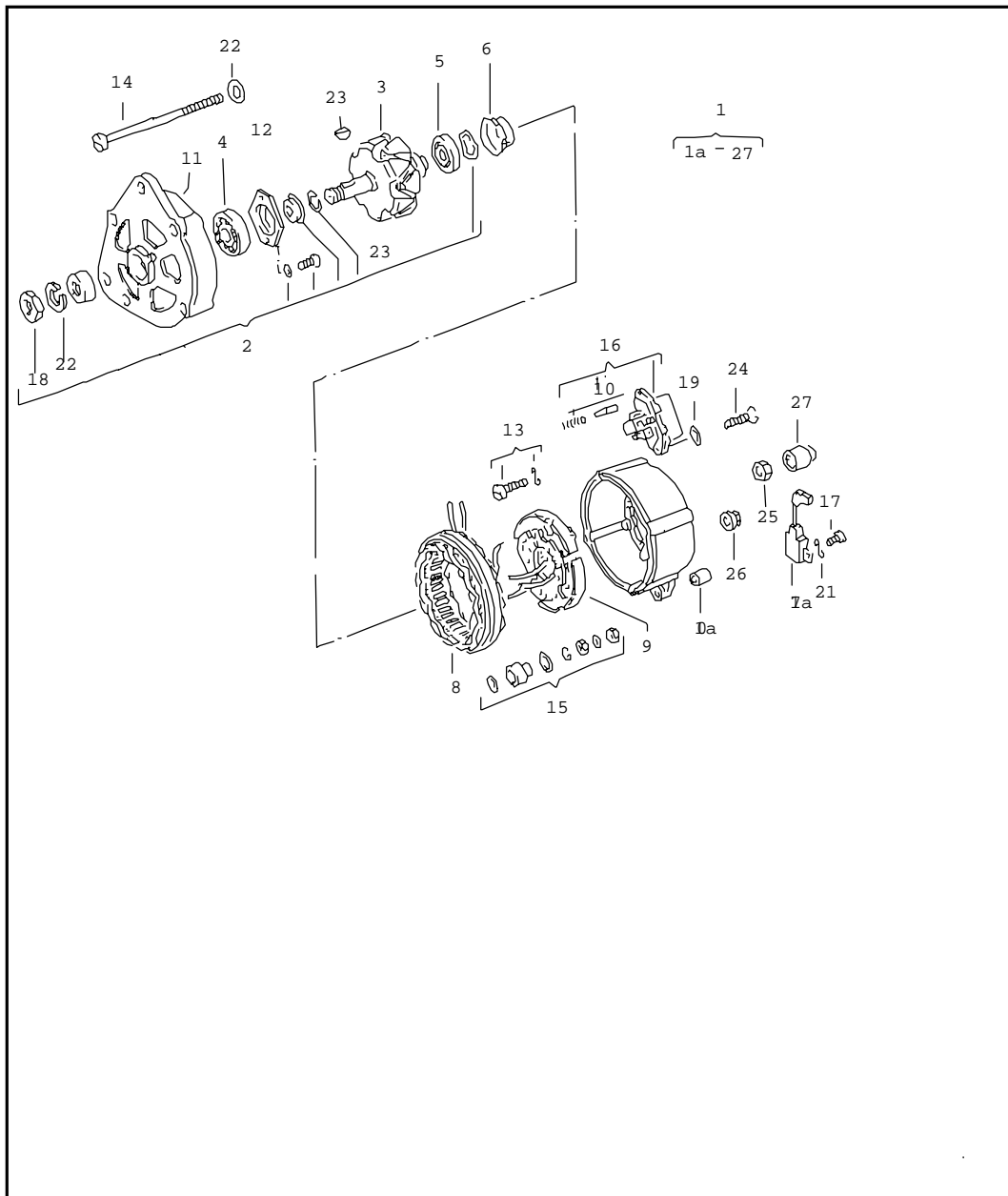

Pos	Part Number	Name	Remarks	Qty	Model
		alternator and single parts	BOSCH		
		for alternator:	1,2,4-10,12,13		
(1)	>027 903 015	alternator	65A	1	
(1)	#027 903 015 X	alternator	65A	1	
(1)	#027 903 015 V	alternator	65A	1	
(1)	>068 903 017 N	alternator	65A	1	
(1)	#026 903 017 AX	alternator	65A	1	
(1)	#068 903 017 NV	alternator	65A	1	
(1)	>068 903 018 B	alternator	90A	1	
(1)	#026 903 017 BX	alternator	90A	1	
(1)	#068 903 017 PV	alternator	90A	1	
(1)	>068 903 017 T	alternator	65A	1	
(1)	#068 903 017 RX	alternator	45A	1	
(1)	#068 903 017 TV	alternator	65A	1	
(1)	#068 903 017 TX	alternator	65A	1	
(1)	#068 903 017 TV	alternator	65A	1	
(1)	>068 903 017 Q	alternator	90A	1	
(1)	#068 903 017 QX	alternator	90A	1	
(1)	#068 903 017 QV	alternator	90A	1	
(1)	>068 903 033 E	alternator	90A	1	
(1)	#068 903 018 EX	alternator	90A	1	
(1)	#068 903 018 EV	alternator	90A	1	
(1)	>051 903 017	alternator	90A	1	

Model	Year	MG	SG	Illustration	VIN No.	Update	19:20	18.02.20100		ETKA	
PA	90	9	03	161-00		336					



Pos	Part Number	Name	Remarks	Qty	Model
		alternator and single parts	BOSCH		
		for alternator:	1,2,4-10,12,13		
(1)	>051 903 017	alternator	90A	1	
(1)	#034 903 017 X	alternator	90A	1	
(1)	#051 903 017 V	alternator	90A	1	
(1)	#051 903 017 X	alternator	90A	1	
(1)	#051 903 017 V	alternator	90A	1	
1A	027 903 149	bush		1	
		for alternator:	5,6,12		
2	028 903 320 B	repair kit for alternator		1	
3	034 903 213 B	claw-pole rotor		1	
		for alternator:	2,5,6-9,12,13		
(3)	068 903 213 F	claw-pole rotor		1	
		for alternator:	9A		
(3)	069 903 213 E	claw-pole rotor		1	
		for alternator:	1,10		
4	021 903 221 E	ball bearing		1	
		for alternator:	1,4,9A,10		
(4)	021 903 221 D	ball bearing		1	
		for alternator:	2,5,6,8,9,12,13		
5	054 903 221 A	ball bearing		1	
6	049 903 223	intermediate ring		1	
		for alternator:	1,2,4-10,13		
(6)	034 903 223 B	splash shield sleeve		1	
		for alternator:	12		
7	056 903 291	suppression condenser		1	

Model	Year	MG	SG	Illustration	VIN No.	Update	19:20	18.02.20100		ETKA	
PA	90	9	03	161-00		336					

Pos	Part Number	Name	Remarks	Qty	Model
		alternator and single parts	BOSCH		
		for alternator:	1,2,4-10,12,13		
7	056 903 291	suppression condenser		1	
8	036 903 351 C	stator winding		1	
		for alternator:	1,4,10		
(8)	036 903 351 D	stator winding		1	
		for alternator:	9A		
(8)	049 903 351 B	stator winding		1	
		for alternator:	2,5-9,12,13		
9	026 903 359	diode plate		1	
		for alternator:	2,5,6		
(9)	036 903 359 H	diode plate		1	
		for alternator:	1,4		
(9)	068 903 359 B	diode plate		1	
		for alternator:	10		
(9)	069 903 359 D	diode plate		1	
		for alternator:	9A		
(9)	075 903 359	diode plate		1	
		for alternator:	8,9,12,13		
10	049 903 515 C	1 set of carbon brushes		1	
(11)	026 903 537 A	starter drive housing		1	
		for alternator:	1		
11	027 903 537	end plate		1	
		for alternator:	5,6		
(11)	027 903 537 A	end plate		1	
		for alternator:	4		
(11)	034 903 537 B	end plate		1	
		for alternator:	12		

Model	Year	MG	SG	Illustration	VIN No.	Update	19:21	18.02.20100		ETKA	
PA	90	9	03	161-00		336					

Pos	Part Number	Name	Remarks	Qty	Model
		alternator and single parts	BOSCH		
		for alternator:	1,2,4-10,12,13		
(11)	036 903 537 C	end plate	for alternator: 10	1	
(11)	049 903 537 D	end plate	for alternator: 2	1	
(11)	068 903 537 C	end plate	for alternator: 9A	1	
(11)	068 903 537 D	end plate	for alternator: 9	1	
(11)	068 903 537 G	end plate	for alternator: 13	1	
(11)	074 903 537 A	starter drive housing	for alternator: 8	1	
12	034 903 543 A	retaining plate	for alternator: 2,5-9,12,13	1	
(12)	059 903 543	retaining plate	for alternator: 1,4,9A,10	1	
13	049 903 555 A	fill. hd. screw (combi.)		3	
14	049 903 555 D	fillister hd. screw	M5X111	4	
15	068 903 791 E	1 set of connecting parts for terminal	B+ / D+	1	
16	068 903 803 D	voltage regulator		1	
17	N 010 704 2	screw, cheese hd.	AM5X10	1	
18	037 903 181	shouldered nut	M16X1,5	1	
19	N 011 522 7	washer	A4, 3X9X0,5	2	
20	N 011 523 18	washer	A5, 3X10X1	1	



Model	Year	MG	SG	Illustration	VIN No.	Update	19:21	18.02.20100		ETKA	
PA	90	9	03	161-00		336					

Pos	Part Number	Name	Remarks	Qty	Model
		alternator and single parts	BOSCH		
		for alternator:	1,2,4-10,12,13		
21	N 012 222 4	spring washer	A5X10X0,5	1	
22	N 012 238 5	spring washer	B16X30X1,6	X	
23	N 012 708 2	woodruff key	4X5	1	
24	N 014 125 1	fillister hd. screw	AM4X18	2	
25	N 011 008 18	hex. nut	M8	1	
26	N 100 173 01	shouldered hex. nut	M5 D+	1	
27	N 904 030 01	cap	13X14	1	

alternator versions



1	>026 903 015 A	65A	BOSCH		EZ,RF,PB,PF RP,1F,2E,AA	068 903 017 N #026 903 017 AX #068 903 017 NV
2	>026 903 015 B	90A	BOSCH		EZ,RF,PB,PF RP,1F,2E,AA	068 903 018 B +037 903 181 #026 903 017 BX #068 903 017 PV
3	>026 903 015 E	65A	VALEO		EZ,RF,PB,PF RP,1F,2E,AA	068 903 017 N +049 903 119 L +068 903 171 #026 903 015 EX 026 903 015 EV
4	>027 903 015	65A	BOSCH		16V	027 903 015 #027 903 015 X #027 903 015 V
5	>027 903 015 A	90A	BOSCH	>>31-K400000	16V	051 903 017 #034 903 017 X #051 903 017 V
6	>027 903 015 C	90A	BOSCH	>>31-K400000	air condit. 16V	051 903 017 #034 903 017 X #051 903 017 V
8	>068 903 029 K	90A	BOSCH		RA,SB,1Y	068 903 017 Q #068 903 017 QV #068 903 017 QX
9	>068 903 029 Q	90A	BOSCH	>>31-M120000	air condit. RA,SB,1Y	068 903 033 E #068 903 018 EX #068 903 018 EV
9A	>068 903 029 T	45A	BOSCH		RA,SB	068 903 017 T #068 903 017 RX #068 903 017 TV
10	>068 903 031	65A	BOSCH		RA,SB,1Y	068 903 017 T #068 903 017 TX #068 903 017 TV
10A	>068 903 031 G	45A	VALEO		RA,SB	068 903 017 T +068 903 119 A +068 903 171 #068 903 031 GX 068 903 031 GV

11	>068 903 031 H	65A	VALEO		RA,SB,1Y	068 903 017 T #068 903 031 HX #068 903 031 HV
12	>051 903 015 B	90A	BOSCH	31-L-000001>>	16V	051 903 017 #051 903 017 X #051 903 017 V
13	>068 903 033 E	90A	BOSCH	31-M-120001>>	air condit. 1Y,SB	068 903 033 E #068 903 018 EX #068 903 018 EV
14	>028 903 023 E	90A	BOSCH		AAZ	028 903 025 E #028 903 025 EX #028 903 025 EV
15	>028 903 023 F	120A	BOSCH		AAZ	028 903 025 R +037 906 240 +357 972 741 A +N 903 353 03 #028 903 025 FX #028 903 025 FV
16	>021 903 023 Q	90A	BOSCH		AAA	028 903 025 E +021 903 119 D #028 903 025 EX #028 903 025 EV
17	>021 903 023 R	120A	BOSCH		AAA	028 903 025 R +037 906 240 +357 972 741 A +N 903 353 03 #028 903 025 FX #028 903 025 FV
18	>026 903 023 B	65A	VALEO		AAA	068 903 017 N +049 903 119 L +068 903 171 #026 903 015 EX #026 903 015 EV

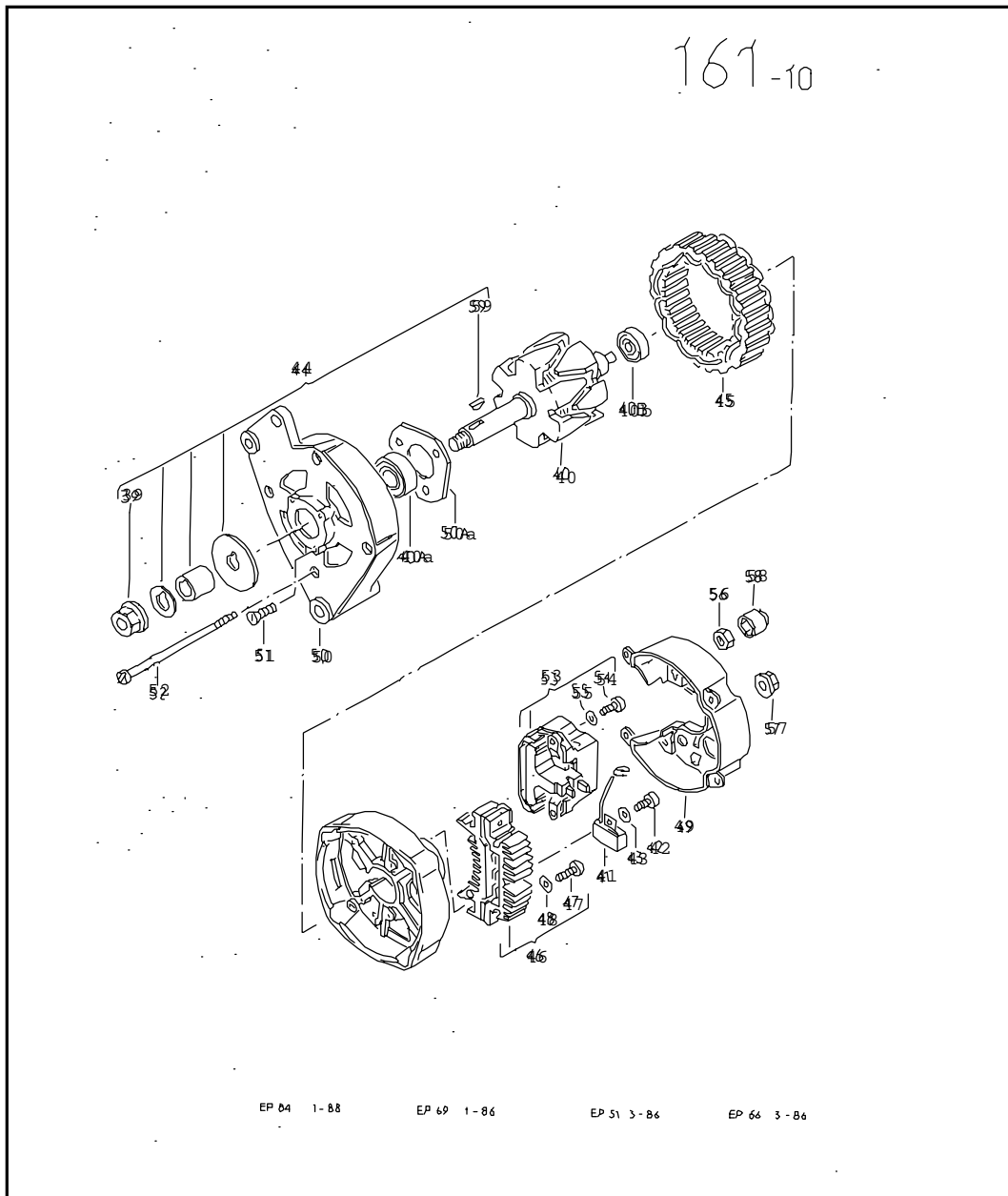

Model	Year	MG	SG	Illustration	VIN No.	Update	19:12	18.02.20100		ETKA	
PA	90	9	03	161-10		336					



Pos	Part Number	Name	Remarks	Qty	Model
		alternator and single parts	VALEO		
		for alternator:	3,10A,11,18		
-	#068 903 031 GX	alternator	45A	1	
-	#068 903 031 GV	alternator	45A	1	
-	#068 903 031 HX	alternator	65A	1	
-	#068 903 031 HV	alternator	65A	1	
-	#026 903 015 EX	alternator	65A	1	
-	#026 903 015 EV	alternator	65A	1	
39	068 903 181	shouldered nut		1	
40	026 903 213	claw-pole rotor	for alternator: 3,10A,11,18	1	
40A	021 903 221 E	ball bearing		1	
40B	055 903 221	ball bearing		1	
41	056 903 291	suppression condenser		1	
42	N 010 704 2	screw, cheese hd.	AM5X10	1	
43	N 012 222 4	spring washer	A5X10X0,5	2	
44	026 903 320	repair kit for alternator	3,18	1	
(44)	036 903 320 A	repair kit for alternator	10A,11	1	
(45)	036 903 351 F	stator winding	for alternator: 10A	1	
(45)	036 903 351 G	stator winding	for alternator: 3,11,18	1	
46	036 903 359 J	diode plate		1	



Model	Year	MG	SG	Illustration	VIN No.	Update	19:22	18.02.20100		ETKA	
PA	90	9	03	161-10		336					

Pos	Part Number	Name	Remarks	Qty	Model
		alternator and single parts	VALEO		
		for alternator:	3,10A,11,18		
47	N 014 156 3	fillister hd. screw	M5X30	2	
48	N 012 222 4	spring washer	A5X10X0,5	2	
49	036 903 521 A	cover		1	
50	026 903 537	end plate		1	
		for alternator:	3,18		
(50)	036 903 537 F	end plate		1	
		for alternator:	10A,11		
50A	055 903 543	retaining plate		1	
51	N 100 622 01	screw, csk. hd.	M4X20	3	
52	036 903 555 D	screw, cheese hd.		4	
53	037 903 803	voltage regulator		1	
54	N 014 118 1	fillister hd. screw	M4X28	2	
55	N 012 221 3	spring washer	A4X8X0,5	2	
56	N 011 008 18	hex. nut	M8	1	
57	N 100 173 01	shouldered hex. nut	M5 D+	1	
58	N 904 030 01	cap	13X14	1	
59	N 012 710 2	woodruff key	4X6,5	1	

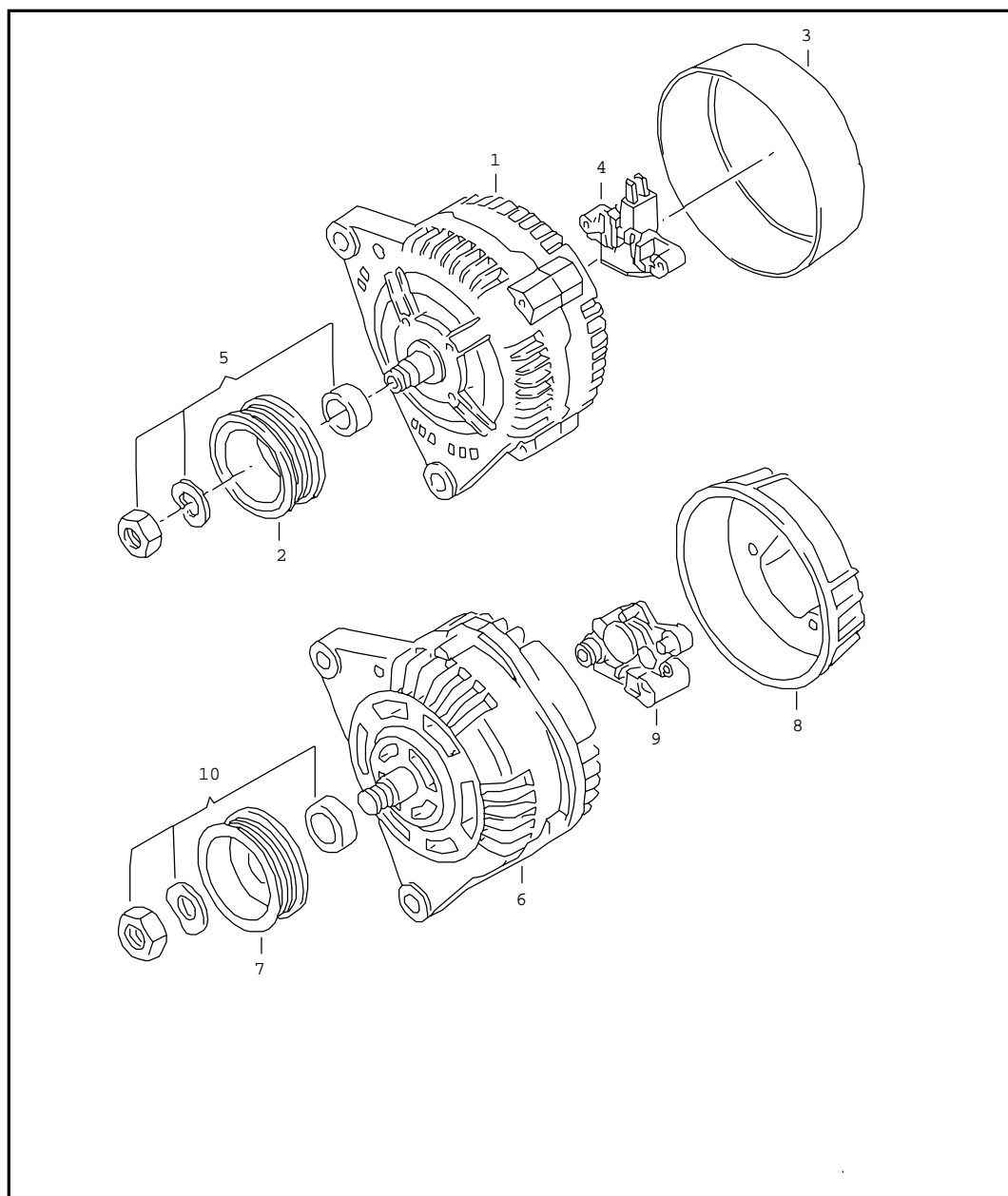

Model	Year	MG	SG	Illustration	VIN No.	Update	19:13	18.02.20100		ETKA	
PA	90	9	03	161-15		336					



Pos	Part Number	Name	Remarks	Qty	Model
		alternator and single parts	BOSCH		
		for alternator:	14,15,16,17		
(1)	>028 903 025 Q	alternator	90A	1	
(1)	#028 903 025 QX	alternator	90A	1	
(1)	#028 903 025 QV	alternator	90A	1	
(1)	>021 903 017 B	alternator	120A	1	
(1)	#028 903 025 RX	alternator	120A	1	
(1)	#028 903 025 RV	alternator	120A	1	
1	>028 903 025 E	alternator	90A	1	
(1)	#028 903 025 EX	alternator	90A	1	
(1)	#028 903 025 EV	alternator	90A	1	
(1)	>028 903 025 R	alternator	120A	1	
(1)	#028 903 025 FX	alternator	120A	1	
(1)	#028 903 025 FV	alternator	120A	1	
2	021 903 119 D	ribbed belt pulley	for alternator: 16,17	1	
(2)	028 903 119 F	ribbed belt pulley	for alternator: 14,15	1	
3	028 903 193 A	protective cap	for alternator: 15,17	1	
(3)	028 903 193 B	protective cap	for alternator: 14,16	1	
4	021 903 803 B	voltage regulator		1	
5	028 903 320 C	repair kit for alternator		1	



Model	Year	MG	SG	Illustration	VIN No.	Update	19:22	18.02.20100		ETKA	
PA	90	9	03	161-15		336					

Pos	Part Number	Name	Remarks	Qty	Model
		alternator and single parts	BOSCH		
		for alternator:	14,15,16,17		
-	037 906 240	flat contact housing	2 pin	1	
-	357 972 741 A	single wiring seal	5,6X7,8	2	
		for wire cross section:	red 1,5		
-	N 903 353 03	flat contact	3,5-2,5	2	

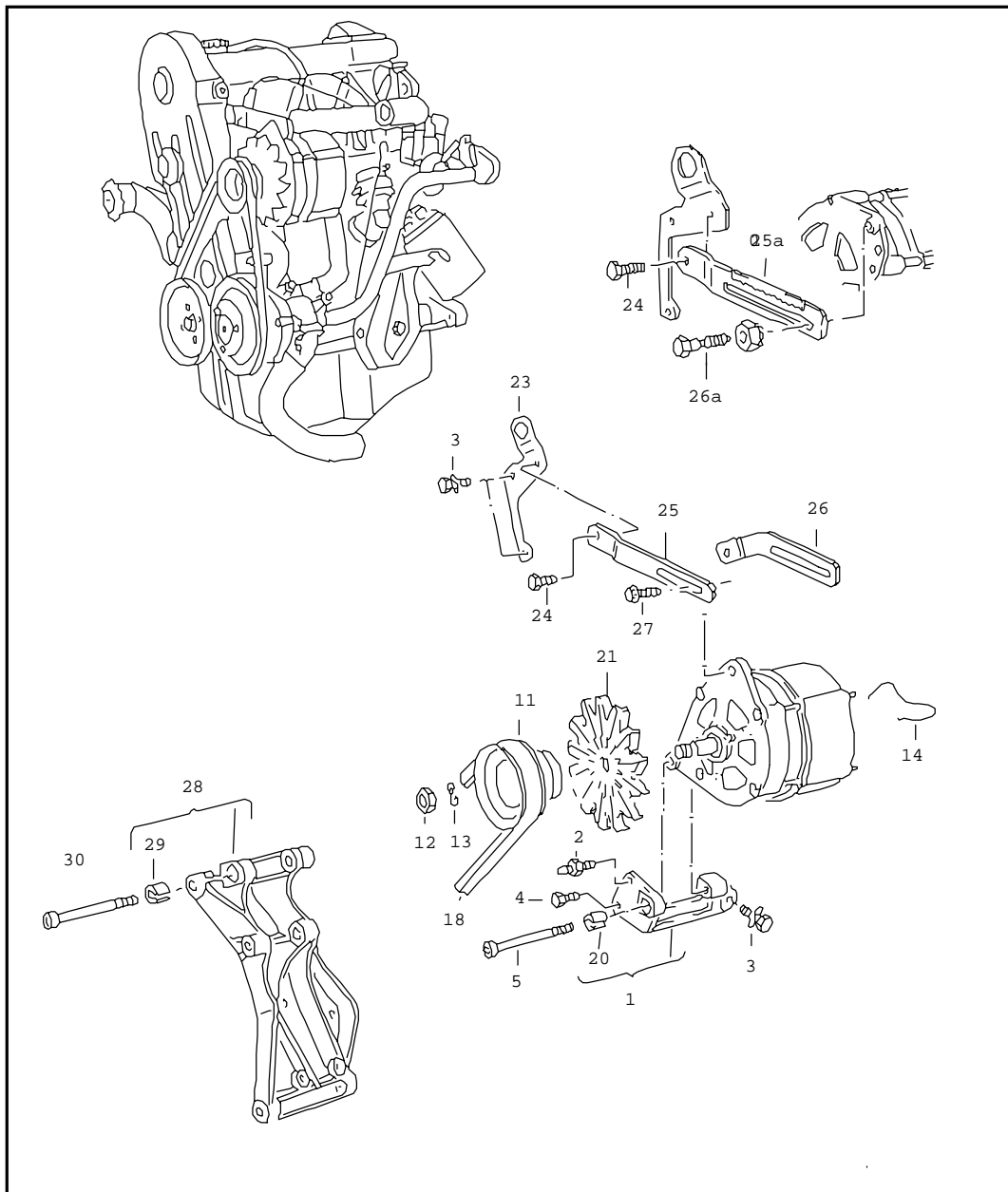

Model	Year	MG	SG	Illustration	VIN No.	Update	18:12	09.02.20100		ETKA	
PA	90	9	03	163-00		336					



Pos	Part Number	Name	Remarks	Qty	Model
		connecting and mounting parts for alternator			4 cylinder
1	049 903 103 B	bracket for alternator		1	
2	049 109 166	stud		1	
3	N 010 242 22	screw, hexagonal head	M8X25	3	
4	N 010 241 15	screw, hexagonal head	M8X22	1	
5	N 044 759 1	bolt, with hex. socket hd.	M8X95	1	
6	N 012 229 3	spring washer	A8X15X0,5	3	
(11)	026 903 119 A	v-belt pulley		1	
		for alternator:	3		
(11)	049 903 119 L	v-belt pulley		1	
		for alternator:	1,2 BOSCH		
12/13		see illustration:	161,161-10		
(18)	027 903 137	v-belt	9,5X630MM	1	air condit.; air condit./ power steering
(18)	054 903 137	v-belt use for:	11,2X866MM 9,5X865MM	1	power steering
18	026 903 137 C	v-belt	9,5X950MM	1	
(18)	050 903 137	v-belt	9,5X950MM	X	
	4/88 7/91 SBV	(self-service pack)			
20	049 903 149	bush	16	1	
21	036 903 171 C	fan wheel		1	
		for alternator:	3 VALEO		
(21)	068 903 171	fan wheel		1	
		for alternator:	1 BOSCH		
(21)	068 903 171	fan wheel		1	
		for alternator:	1 BOSCH		
(21)	068 903 171 A	fan wheel		1	
		for alternator:	2 BOSCH		
23	026 903 245 A	bracket		1	
(23)	048 903 245	bracket	2.0ltr.	1	



Model PA	Year 90	MG 9	SG 03	Illustration 163-00	VIN No.	Update 336	18:12	09.02.20100		ETKA	
-------------	------------	---------	----------	------------------------	---------	---------------	-------	-------------	---	------	---

Pos	Part Number	Name	Remarks	Qty	Model	Pos	Part Number	Name	Remarks	Qty	Model
24	N 019 526 5	bolt, hex. hd. with shoulder	M8X22	1							
(24)	N 019 502 2	bolt, hex. hd. with shoulder	M8X25	1							
25A	026 903 247 B	bracket		1							
(25A)	027 903 247	bracket		1	air condit.						
26A	026 903 555 A	bolt		1							
28	027 260 881	bracket - compressor		1	air condit.						
29	049 903 149	bush		1	air condit.						
30	N 044 759 1	bolt, with hex. socket hd.	M8X95	1	air condit.						

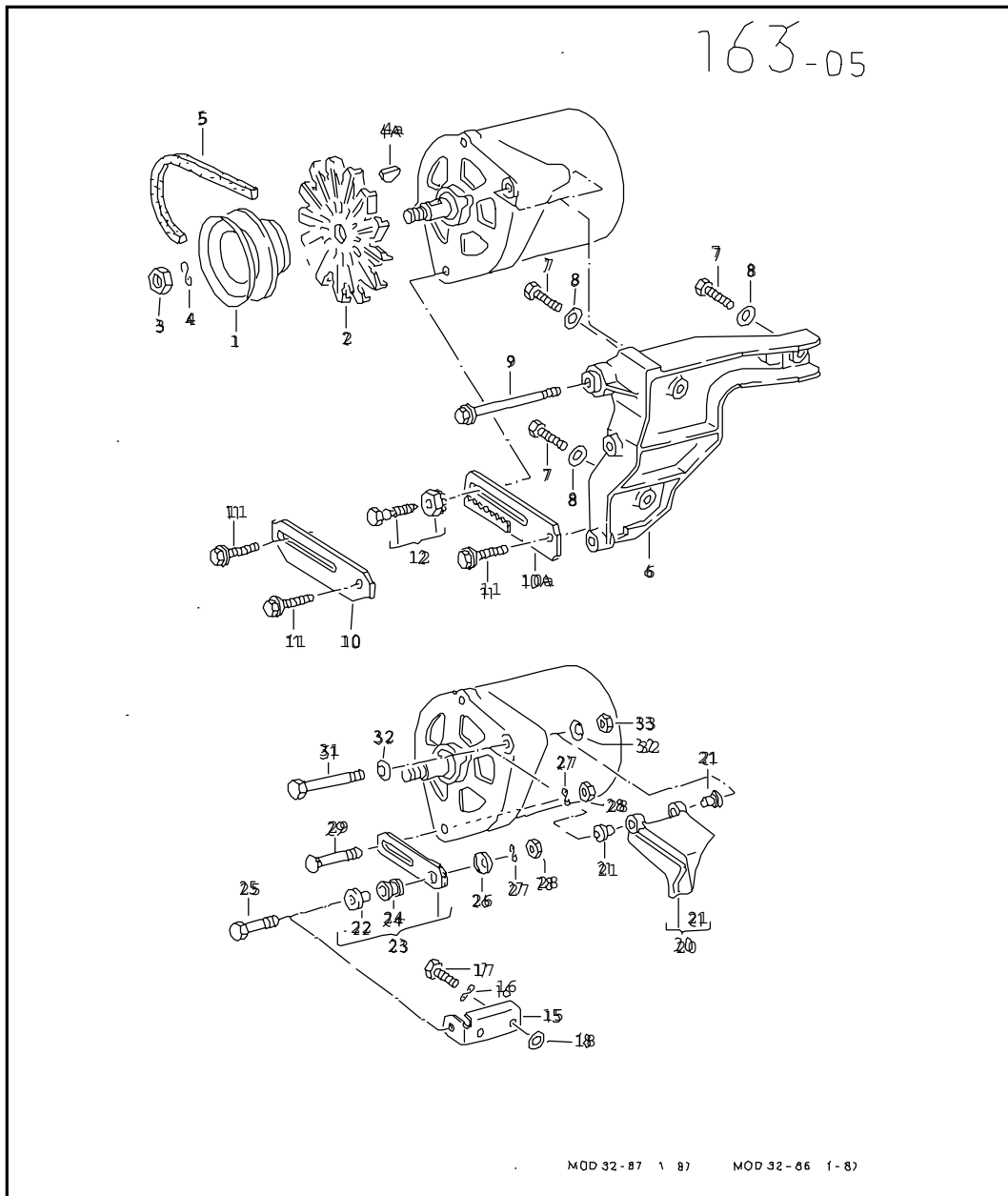

Model	Year	MG	SG	Illustration	VIN No.	Update	16:52	18.02.20100		ETKA	
PA	90	9	03	163-05		336					



Pos	Part Number	Name	Remarks	Qty	Model
		connecting and mounting parts for alternator			diesel eng.: RA,SB,1Y
1	035 903 119	v-belt pulley		1	
		for alternator:	9,13		
(1)	068 903 119 A	v-belt pulley		1	
		for alternator:	8,9A,10		
(1)	068 903 119 H	v-belt pulley		1	
		for alternator:	9B,11		
2	036 903 171 C	fan wheel	VALEO	1	
		for alternator:	9B,11		
(2)	068 903 171	fan wheel	BOSCH	1	
		for alternator:	9A,10		
(2)	068 903 171 A	fan wheel	BOSCH	1	
		for alternator:	8,9,13		
3/4		see illustration:	161,161-10		
4A		see illustration:	161,161-10		
(5)	054 903 137	v-belt	11,2X866MM	1	power steering
5	068 903 137 AR	v-belt	11,9X950MM	1	
(5)	068 903 137 AQ	v-belt	9,5X695MM	1	air condit.; air condit./ power steering
6	068 903 141 T	bracket for alternator		1	
-	068 903 147 G	bush		1	
(7)	N 010 351 6	screw, hexagonal head	M8X52	2	
8	N 011 558 11	washer	8,4X15X1,6	4	
(9)	N 100 156 01	screw, hexagonal head	M10X95SP	1	
(10A)	068 903 251 E	bracket		1	air condit.
		F	>> 31-M-080 001		
10A	068 903 251 Q	bracket		1	air condit.
		F	31-M-080 000>>		
(10A)	028 903 251	bracket		1	
(11)	N 019 502 2	bolt, hex. hd. with shoulder	M8X25	1	air condit.
(11)	N 100 155 01	bolt, hex. hd. with shoulder	BM8X70	1	



Model	Year	MG	SG	Illustration	VIN No.	Update	16:52	18.02.20100		ETKA	
PA	90	9	03	163-05		336					

Pos	Part Number	Name	Remarks	Qty	Model	Pos	Part Number	Name	Remarks	Qty	Model
12	026 903 555 A	bolt		1							
(12)	N 019 700 1	bolt, hex. hd. with shoulder	M8X30	1	air condit.						
-	068 199 356	bracket		1							

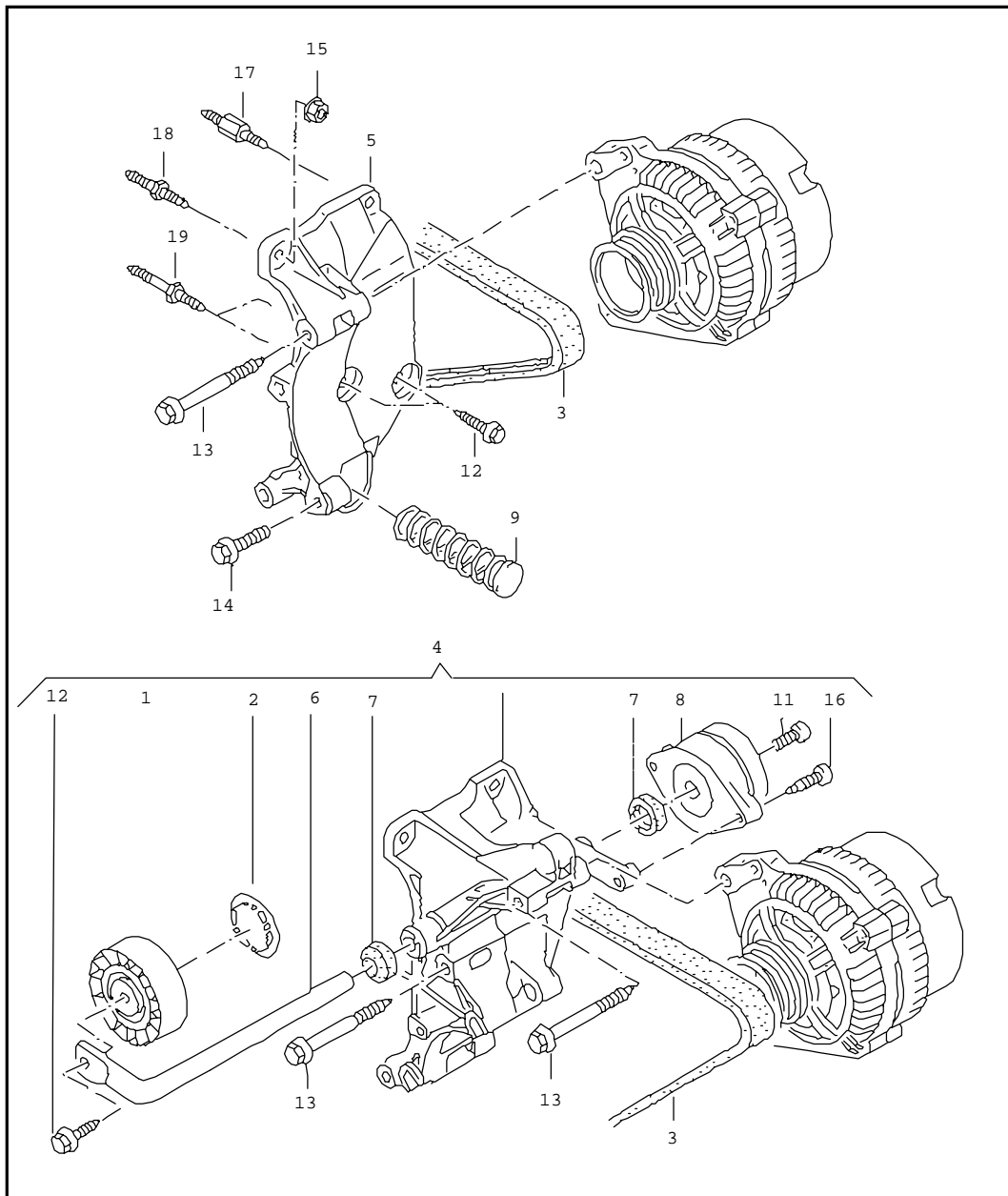

Model	Year	MG	SG	Illustration	VIN No.	Update	16:52	18.02.20100		ETKA	
PA	90	9	03	163-10		336					



Pos	Part Number	Name	Remarks	Qty	Model
		connecting and mounting parts for alternator ribbed v-belt			diesel eng.: AAZ
1	028 145 278 E	tensioning roller		1	AAZ,1Z
2	028 145 291	protective cap use for:	028 145 278 A	1	
(2)	028 145 291 A	protective cap use for:	028 145 278 E	1	
3	028 903 137 T	ribbed v-belt F >> 31-M-330 000*	21,36X1045MM	1	
(3)	028 903 137 T	ribbed v-belt F 31-M-330 001>>*	21,36X1045MM for alternator: 120A	1	
(3)	028 903 137 AD	ribbed v-belt F 31-M-330 001>>*	21,36X923MM	1	
4	028 903 139 J	bracket for alternator for vehicles with air condit.	120A	1	
5	028 903 143 AD	bracket for alternator		1	
6	028 903 308 C	tensioning lever		1	
(6)	028 903 308 G	tensioning lever	only for: 028 903 315 R	1	
7	028 903 310	dust cap		2	
8	028 903 315 R	tensioner	also use: 028 903 308 G N 014 712 3	1 1 2	
9	028 903 329	retaining clip		1	
11	N 014 740 4	bolt, with hex. socket hd.	M6X16	1	
12	N 019 526 5	bolt, hex. hd. with shoulder	M8X22	2	
13	N 101 208 03	bolt, hex. hd. with shoulder	M8X85	1	
14	N 905 649 01	bolt, hex. hd. (combi.)	M8X39	1	
(14)	N 101 208 03	bolt, hex. hd. with shoulder	M8X85	1	air condit.
15	N 902 291 02	shouldered hex. nut	M8	2	
16	N 014 709 1	bolt, with hex. socket hd.	M8X22	X	



Model	Year	MG	SG	Illustration	VIN No.	Update	16:52	18.02.20100		ETKA	
PA	90	9	03	163-10		336					

Pos	Part Number	Name	Remarks	Qty	Model	Pos	Part Number	Name	Remarks	Qty	Model
(16)	N 014 712 3	bolt, with hex. socket hd.	M8X18	X							
(16)	N 102 408 01	bolt, with hex. socket hd.	M8X35	X							
17	028 260 821 C	stud with shoulder	M8X17X24	1							
18	028 260 821	stud with shoulder	M8X34X24	1							
19	028 260 821 A	stud with shoulder	M8X55X31	2							

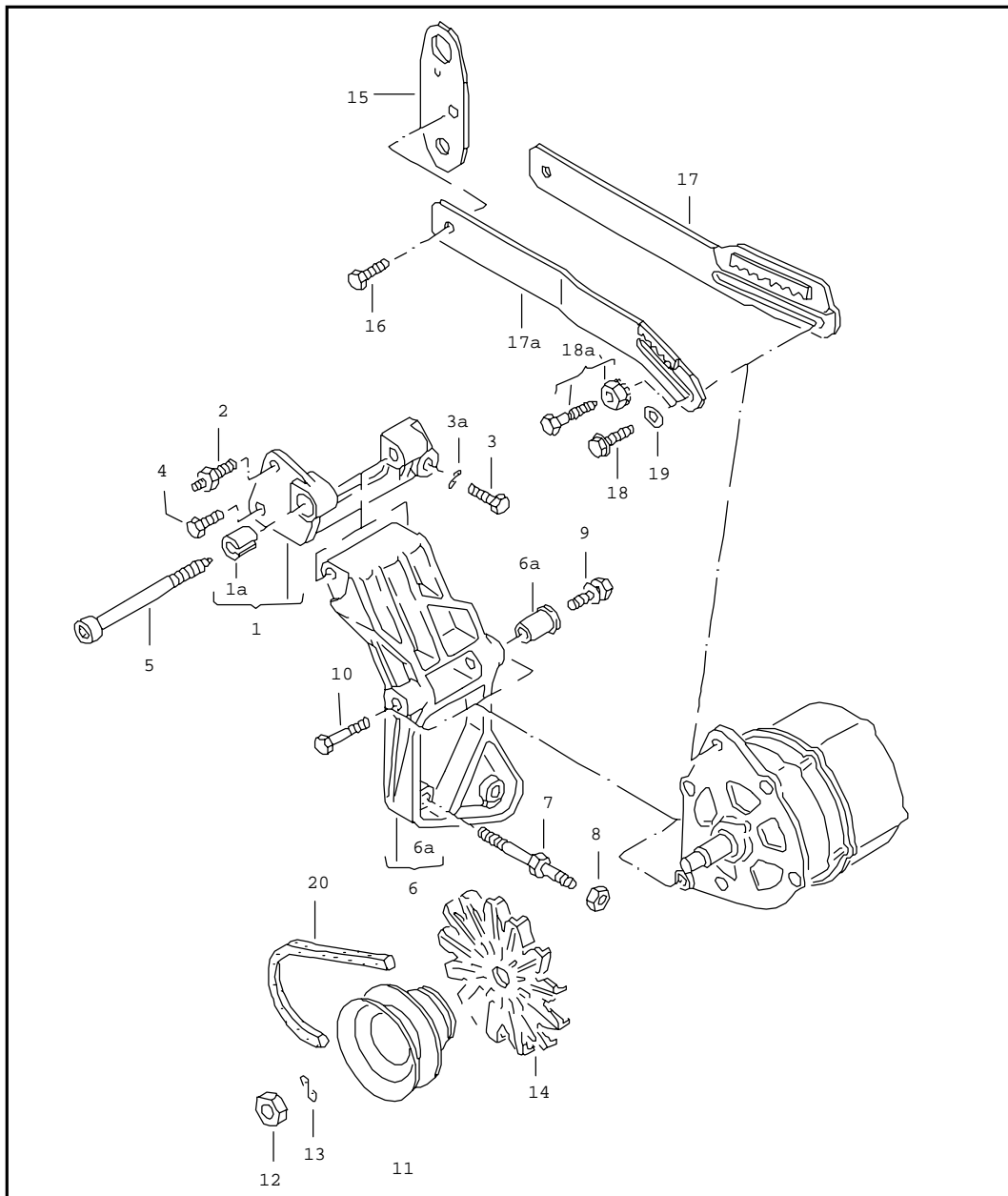

Model	Year	MG	SG	Illustration	VIN No.	Update	16:52	18.02.20100		ETKA	
PA	90	9	03	163-20		336					



Pos	Part Number	Name	Remarks	Qty	Model
		connecting and mounting parts for alternator			16V
1	049 903 103 B	bracket for alternator		1	
		replace:	049 903 149		
			by		
			068 903 149 B	1	
-	N 011 904 4	cover	2.0ltr.	1	
(1A)	068 903 149 B	bush	13MM	1	
2	049 109 166	stud		1	
3	N 010 242 22	screw, hexagonal head	M8X25	1	
3A	N 012 229 3	spring washer	A8X15X0,5	1	
4	N 010 241 15	screw, hexagonal head	M8X22	1	
5	N 044 759 1	bolt, with hex. socket hd.	M8X90	1	
(6)	051 260 885 A	bracket		1	
(6)	051 260 881	bracket		1	air condit.;
6A	037 260 921	threaded bush		1	air condit.
(7)	051 260 821	stud with hex. hd.	M8X54/M8X23	2	
-	051 260 907	cotter, split		1	
-	051 260 909	spring pin		1	
(8)	N 900 744 01	hex. nut, self-locking	M8	2	
9	N 090 314 1	bolt, hex. hd. (combi.)	M10X38Z1	1	
10	N 010 441 4	screw, hexagonal head	M10X42	1	
(11)	027 903 119	v-belt pulley		1	
		for alternator:	6		
11	049 903 119 L	v-belt pulley		1	
		for alternator:	4,5		
(11)	051 903 119	v-belt pulley		1	
		for alternator:	12		
12/13		see illustration:	161,161-10		
(14)	068 903 171	fan wheel		1	
		for alternator:	BOSCH		



Model	Year	MG	SG	Illustration	VIN No.	Update	16:52	18.02.20100		ETKA	
PA	90	9	03	163-20		336					

Pos	Part Number	Name	Remarks	Qty	Model	Pos	Part Number	Name	Remarks	Qty	Model
(14)	034 903 171	fan wheel for alternator:	BOSCH 5,6,12	1							
(15)	027 103 390	plate		1							
16	N 019 502 2	bolt, hex. hd. with shoulder	M8X25	1							
(17)	027 903 133 E	bracket	also use: 027 903 555	1 1							
17A	027 903 133 D	bracket		1	air condit.						
18	N 019 700 1	bolt, hex. hd. with shoulder	M8X30	X							
(18)	027 903 555	bolt		1							
(18)	N 010 246 4	screw, hexagonal head	BM8X45	1	air condit.						
19	N 900 333 01	washer	B8,4X20X2,5	1	air condit.						
20	026 903 137 C	v-belt	9,5X950MM	1							
(20)	027 903 137	v-belt	9,5X630MM	1	air condit.						

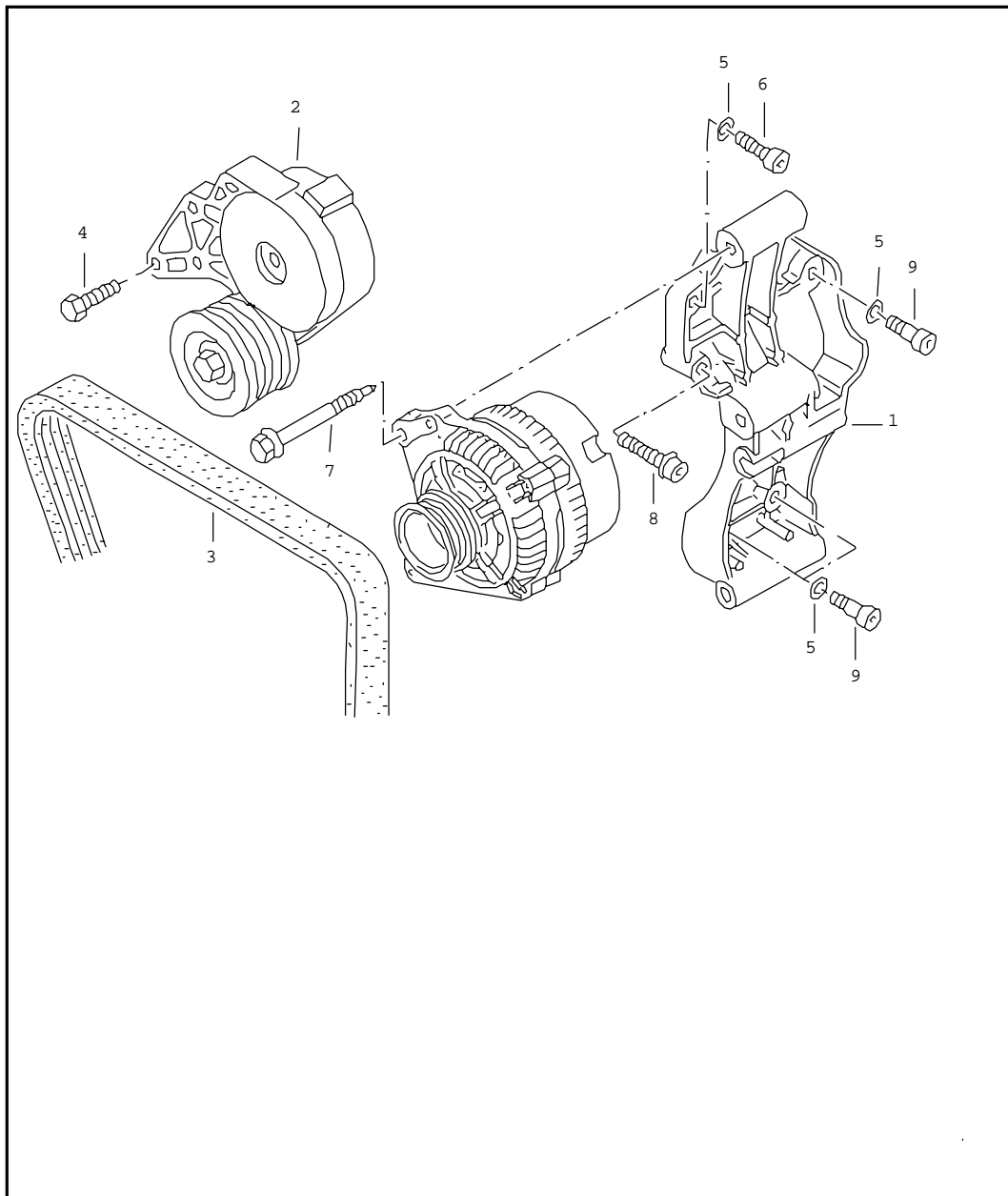

Model	Year	MG	SG	Illustration	VIN No.	Update	16:53	18.02.20100		ETKA	
PA	90	9	03	163-30		336					





Pos	Part Number	Name	Remarks	Qty	Model
		connecting and mounting parts for alternator			6 cylinder
1	021 260 087	bracket for alternator and refrigerant compressor		1	
2	021 145 299	belt tensioning damper		1	
3	021 145 933 C	ribbed v-belt	24,92X1290MM	1	
(3)	021 145 933 H	ribbed v-belt	24,92X1360MM	1	air condit.
4	N 010 244 21	screw, hexagonal head	M8X30	3	
5	N 011 525 13	washer	A8,4	4	
6	N 014 726 3	bolt, with hex. socket hd.	M8X30	1	
7	N 101 208 03	bolt, hex. hd. with shoulder	M8X85	2	
8	N 904 050 02	bolt, with hex. socket hd. (combi.)	M8X38	1	
9	N 904 263 01	fitted bolt	M8X28	3	

Model	Year	MG	SG	Illustration	VIN No.	Update	15:17	18.02.20100		ETKA	
PA	90	9	03	163-40		336					

Pos	Part Number	Name	Remarks	Qty	Model
-	027 903 137	v-belt for alternator	9,5X630MM	1	air condit.; KLIMAANLAGE/ power steering: RP,PF,PB,KR, 9A,2E
-	026 903 137 C	v-belt	9,5X950MM	1	RF,EZ,1F,RP; power steering: KR,9A
-	054 903 137	v-belt use for:	11,2X866MM 9,5X865MM	1	power steering: RF,EZ,1F,RP, PF,PB,2E
-	068 903 137 AQ	v-belt	9,5X695MM	1	air condit.; air condit./ power steering: RA,SB,1Y
-	068 903 137 AR	v-belt	11,9X950MM	1	RA,SB,1Y
-	028 903 137 T	ribbed v-belt F >> 31-M-330 000*	21,36X1045MM	1	AAZ
-	028 903 137 T	ribbed v-belt F 31-M-330 001>>* for alternator:	21,36X1045MM 120A	1	AAZ
-	028 903 137 AD	ribbed v-belt F 31-M-330 001>>*	21,36X923MM	1	AAZ
-	021 145 933 C	ribbed v-belt	24,92X1290MM	1	AAA
-	026 145 271	v-belt for power steering	9,5X730MM	1	RF,EZ,1F,RP, PF,PB,KR,9A, 2E,AAM
-	068 145 271 B	v-belt	9,5X740MM	1	1Y,RA,SB
-		v-belt for air conditioner			



Model	Year	MG	SG	Illustration	VIN No.	Update	15:17	18.02.20100		ETKA	
PA	90	9	03	163-40		336					

Pos	Part Number	Name	Remarks	Qty	Model	Pos	Part Number	Name	Remarks	Qty	Model
-	068 260 849 G	v-belt	12,5X947MM	1	RP,PF,PB,KR, 9A,2E						
-	068 903 137 AQ	v-belt	9,5X695MM	1	air condit.; air condit./ power steering: 1Y,RA,SB						
-	028 260 849 D	ribbed v-belt	21,36X1145MM	1	AAZ						
-	021 145 933 H	ribbed v-belt	24,92X1360MM	1	AAA						

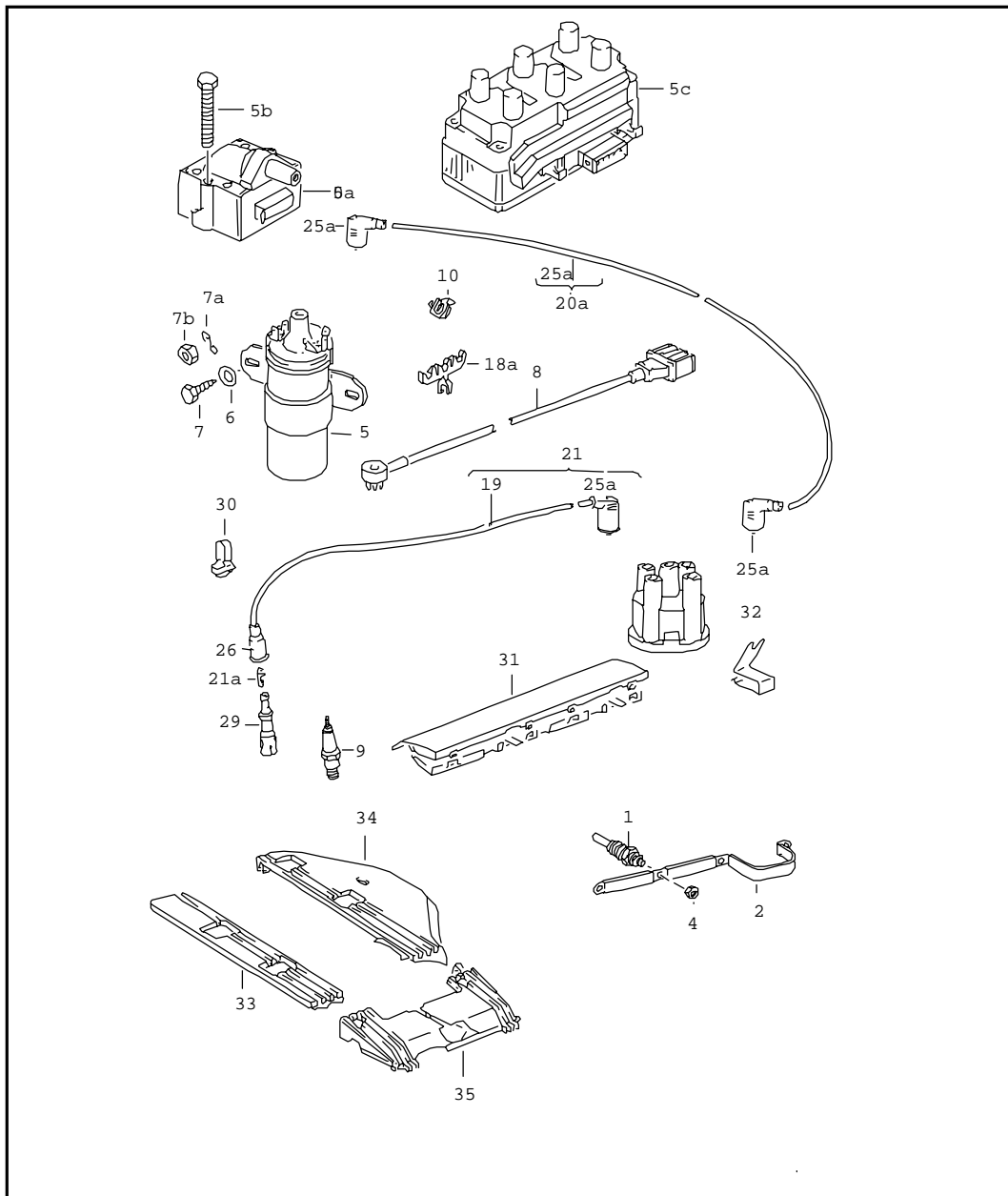

Model	Year	MG	SG	Illustration	VIN No.	Update	16:53	18.02.20100		ETKA	
PA	90	9	05	164-00		336					



Pos	Part Number	Name	Remarks	Qty	Model
(1)	N 102 130 02	ignition coil ignition lead glow plug glow plug		4 4 4 4	AAZ,RA,SB 1Y 1Y
-	028 998 019	retrofit set for glow plugs and relay		1	diesel eng.
2	068 972 095 B	current rail		1	diesel eng.
4	N 022 154 1	hex. nut, self-locking	M5	4	RA,SB,1Y,AAZ
(5)	191 905 115 A	ignition coil F >> 31-K-400 000		1	RF,EZ,KR
5	211 905 115 D	ignition coil F 31-L-000 001>> F 31-L-000 001>> 31-M-240 000		1 1 1	1F,PF,PB RF,KR EZ
(5)	211 905 115 D	ignition coil F >> 31-L-400 000		1	RP
(5)	357 905 115	ignition coil		1	9A
5A	357 905 105	ignition transformer single parts for: assembly(assy) final stage 'tsz' see illustration:	'TSZ' 357 905 104 166-10	1	AAA
(5A)	867 905 105 A	ignition transformer F 31-M-000 001>> F 31-M-066 001>> single parts for: assembly(assy) final stage 'tsz' see illustration:	'TSZ' 701 905 104 A 867 905 104A/B 166-10	1 1 1	2E AAM,RP EZ
5B	N 010 337 3	screw, hexagonal head	M6X65	2	
(6)	N 011 666 10	washer	B6,1X18X2	2	
7	N 015 946 1	tapping screw,hex.hd.	A6,5X19	2	
(7)	N 010 212 26	screw, hexagonal head	M6X12	2	RF,EZ
7A	N 012 226 5	spring washer	B6	2	
7B	N 011 006 24	hex. nut	M6	2	
8	051 905 381	impulse sender		1	9A

Model	Year	MG	SG	Illustration	VIN No.	Update	16:53	18.02.20100		ETKA	
PA	90	9	05	164-00		336					

Pos	Part Number	Name	Remarks	Qty	Model	Pos	Part Number	Name	Remarks	Qty	Model
(9)	101 000 006 AD	spark plug 'longlife' F >> 31-K-400 000	W8DCO BOSCH SPECIAL	4	RF,EZ	(9)	101 000 035 AB	spark plug 'longlife'	BK5REKU NGK	6	AAA
(9)	101 000 002 AA	spark plug 'longlife' F >> 31-K-400 000	14-8DUO BERU SPECIAL	4	RF,EZ	10	N 902 055 01	cable binder	4,5X140	1	
(9)	101 000 000 AC	spark plug 'longlife' F >> 31-K-400 000	N9-YCX SPECIAL CHAMPION	4	RF,EZ	18A	049 905 451	holder for ignition leads		X	
(9)	101 000 005 AD	spark plug 'longlife' F 31-L-000 001>>	W8DTC BOSCH	4	EZ	19	N 018 385 1	ignition cable in coils of 50m 'order unit 50'		*	
(9)	101 000 027 AC	spark plug 'longlife' F 31-L-000 001>>	BP5ET-10 NGK	4	EZ	20A	N 100 529 07	ignition lead (ignition coil > distributor)	B4X520	1	RF,EZ,RP,PF, PB,1F,AAM
(9)	101 000 001 AD	spark plug 'longlife' F 31-L-000 001>>	14-8DTU BERU	4	EZ	(20A)	N 038 885 10	ignition lead (ignition coil > distributor)	B1X320	1	KR,9A
(9)	101 000 007 AC	spark plug 'longlife' F 31-L-000 001>>	N9BYC4CHAMPION	4	EZ	(20A)	N 100 529 02	ignition lead (ignition coil > distributor)	460MM	1	AAA
(9)	101 000 036 AB	spark plug 'longlife'	BUR5ET NGK	4	AAM,1F	21	N 100 502 05	ignition lead	B1X460	4	
(9)	101 000 036 AC	spark plug 'longlife'	BUR5ET-10 NGK	4	RF	(21)	N 100 526 01	ignition lead	B1X760MM cylinder 1,2	2	KR,9A
(9)	101 000 040 AE	spark plug 'longlife'	14GH-8 DTURX BERU	4	RF	(21)	N 100 526 03	ignition lead	B1X600MM cylinder 3,4	2	KR,9A
(9)	101 000 026 AB	spark plug 'longlife'	N7BMC CHAMPION	4	2E	21	N 905 402 07	ignition lead	B1X860MM cylinder 1	1	AAA
(9)	101 000 036 AA	spark plug 'longlife'	BUR6ET NGK	4	2E	(21)	N 905 402 08	ignition lead	B1X800MM cylinder 2	1	AAA
(9)	101 000 005 AB	spark plug 'longlife'	W7DTC BOSCH	4	PF,PB	(21)	N 905 402 03	ignition lead	B1X760MM cylinder 3	1	AAA
(9)	101 000 005 AB	spark plug 'longlife'	W7DTC BOSCH	4	PF,PB	(21)	N 905 402 09	ignition lead	B1X660MM cylinder 4	1	AAA
(9)	101 000 027 AA	spark plug 'longlife'	BP6ET NGK	4	PF,PB	(21)	N 905 402 05	ignition lead	B1X620MM cylinder 5	1	AAA
(9)	101 000 001 AC	spark plug 'longlife'	14-7DTU BERU	4	PF,PB	(21)	N 905 402 10	ignition lead	B1X520MM cylinder 6	1	AAA
(9)	101 000 007 AB	spark plug 'longlife'	N7BYC CHAMPION	4	PF,PB	21A	036 905 423	connector for ignition leads		4	
(9)	101 000 026 AA	spark plug 'longlife'	N9BMC CHAMPION	4	PF	25A	036 035 281 A	connector (screened) for ignition leads		5	
(9)	101 000 036 AA	spark plug 'longlife'	BUR6ET NGK	4	RP	26	311 905 429 A	protective cap		4	
(9)	101 000 004 AA	spark plug 'longlife'	F6DTC BOSCH	4	KR	(29)	021 035 255 E	spark plug connector		6	AAA
(9)	101 000 028 AA	spark plug 'longlife'	BCP7ET NGK	4	KR						
(9)	101 000 003 AA	spark plug 'longlife'	14F-6DTU BERU	4	KR						
(9)	101 000 017 AA	spark plug 'longlife'	C6BYC CHAMPION	4	KR						
(9)	101 000 033 AB	spark plug 'longlife'	BKUR7ET NGK	4	9A						

Model	Year	MG	SG	Illustration	VIN No.	Update	16:53	18.02.20100		ETKA	
PA	90	9	05	164-00		336					



Pos	Part Number	Name	Remarks	Qty	Model	Pos	Part Number	Name	Remarks	Qty	Model
29	036 035 255 E	spark plug connector		4							
(29)	027 905 447	spark plug connector		4	KR,9A						
30	027 905 448 A	extractor ring		4	KR						
(30)	054 905 448	extractor ring		1	9A						
31	053 905 487 A	guide tube		1	KR,9A						
32	027 905 478 B	retaining clip		1	9A						
				2	KR						
32	027 905 478 B	retaining clip		1	9A						
				2	KR						
(32)	027 905 478 C	retaining clip		1	KR,9A						
33	021 133 917	cable holder	front	1	AAA						
34	021 133 918	cable holder	rear	1	AAA						
35	021 133 919	cover for distributor		1	AAA						

distributor versions

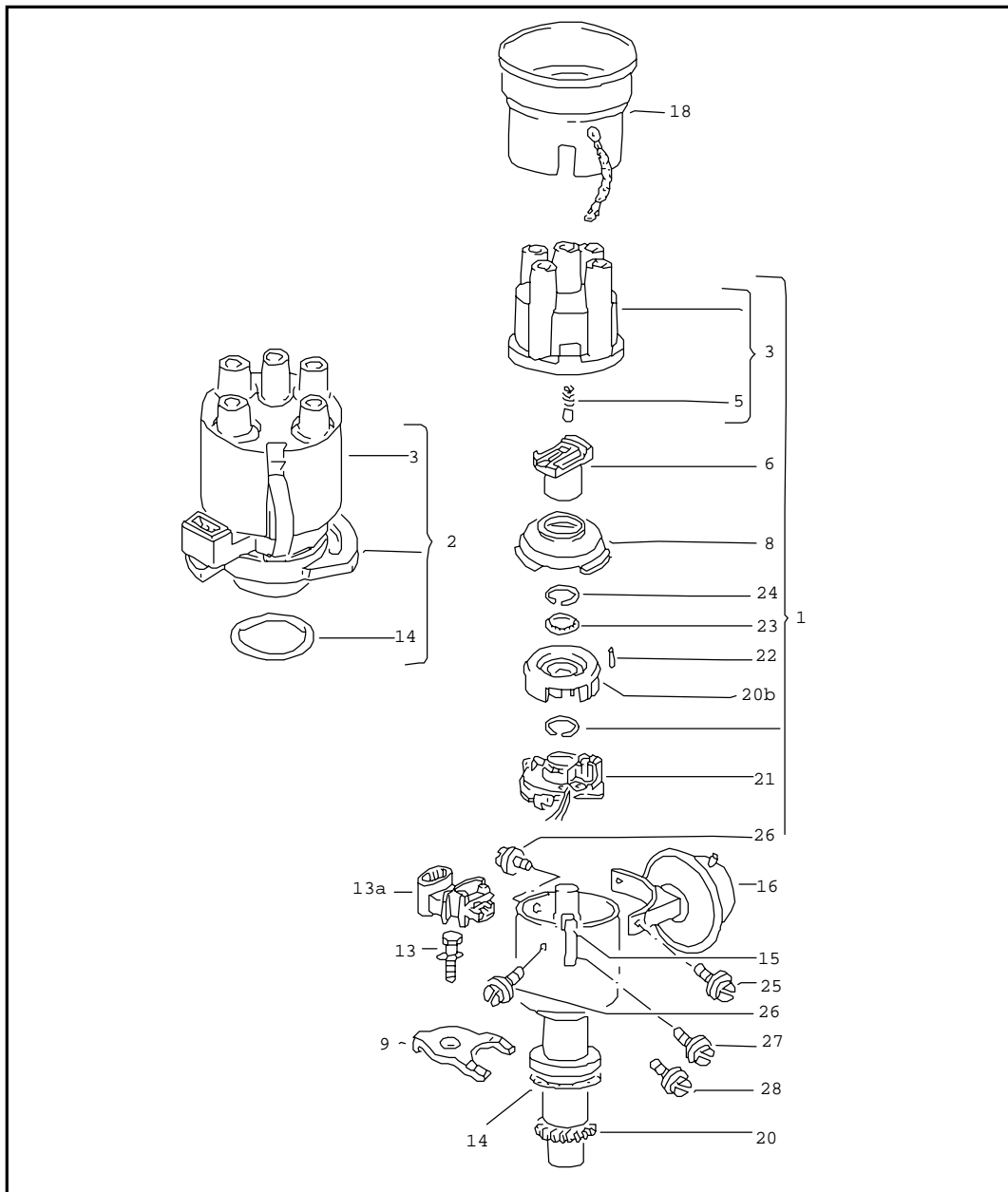

1	050 905 205 K	BOSCH	>>31-L160000	RF,EZ	050 905 205 P
1A	050 905 205 P	BOSCH	31-L-160001>>31-M280000	EZ	050 905 205 P
1B	050 905 205 AM	BOSCH M	31-M-280001>>	EZ	050 905 205 AM
2	050 905 205 A	BOSCH	>>31-L400000	RP	050 905 205 A
3	051 905 205	BOSCH		1F	051 905 205
4	037 905 205	BOSCH	>>31-L160000	PF,PB	037 905 205 K
4A	037 905 205 F	BOSCH	31-L-160001>>	PF,PB	037 905 205 K
5	027 905 205 P	BOSCH		KR	051 905 205 C
6	051 905 205 A	BOSCH	>>31-L300000	9A	051 905 205 A
7	051 905 205 B	BOSCH	31-L-300001>>	9A	051 905 205 C
8	037 905 205 C	BOSCH	>>31-M280000	2E	037 905 205 J
8A	037 905 205 J	BOSCH	31-M-280001>>	2E	037 905 205 J
9	026 905 205 S	BOSCH	31-M-000001>>	AAM,RP	050 905 205 AH
10	021 905 205 AE	BOSCH E		AAA	021 905 205 AF





Pos	Part Number	Name	Remarks	Qty	Model
		distributor			
(1)	021 905 205 AF	distributor		1	AAA
(1)	050 905 205 P	distributor		1	EZ,RF
(1)	050 905 205 AM	distributor		1	EZ
(1)	050 905 205 A	distributor F	>> 31-L-400 000	1	RP
(1)	050 905 205 AH	distributor F 31-M-000 001>>		1	AAM
				1	RP
(1)	051 905 205	distributor		1	1F
(1)	037 905 205 J	distributor		1	2E
(1)	037 905 205 K	distributor		1	PB,PF
(2)	051 905 205 C	distributor		1	KR,9A
3	027 905 207	distributor cap for distributor:	1	1	
(3)	027 905 207 A	distributor cap for distributor:	2,3,4,5,6,9	1	
(3)	030 905 207	distributor cap for distributor:	1A,4A,8	1	
(3)	051 905 207	distributor cap for distributor:	1B,7,7A,8A	1	
(3)	021 905 207	distributor cap for distributor:	10	1	
5	111 905 221 A	carbon brush with spring		1	
(6)	052 905 225 C	rotor for distributor for distributor:	10MM 4,4A,5,6,7,8, 8A,9	1	
6	055 905 225 B	rotor for distributor for distributor:	1,1A,1B,2,3	1	

Model	Year	MG	SG	Illustration	VIN No.	Update	19:23	18.02.20100		ETKA	
PA	90	9	05	165-00		336					

Pos	Part Number	Name	Remarks	Qty	Model
		distributor			
6	055 905 225 B	rotor for distributor for distributor:	1,1A,1B,2,3	1	
(6)	055 905 225 B	rotor for distributor for distributor:	1,1A,1B,2,3	X	
	4/88 7/91 SBV	(self-service pack)			
(6)	021 905 225 B	rotor for distributor for distributor:	10	1	
8	039 905 241	dust cover for distributor:	1,1A,1B,2,3	1	
(8)	052 905 241 C	dust cover for distributor:	4,9	1	
(8)	027 905 241	dust cover for distributor:	5	1	
(8)	037 905 241	dust cover for distributor:	4A,8,8A	1	
(8)	021 905 241	dust cover for distributor:	10	1	
9	035 905 251 B	bracket		1	
13	N 010 242 22	screw, hexagonal head	M8X25	1	
(13)	N 010 215 27	screw, hexagonal head	M6X15	2	AAA
(13)	N 011 547 6	washer	A6,5X14X1,6	2	AAA
-	N 012 229 3	spring washer	A8X15X0,5	1	
(14)	026 905 261	sealing washer for distributor:	1,1A,1B,2,3,4, 4A,9	1	
(14)	027 905 261	sealing washer for distributor:	5,6,7,7A	1	

Model	Year	MG	SG	Illustration	VIN No.	Update	19:23	18.02.20100		ETKA	
PA	90	9	05	165-00		336					

Pos	Part Number	Name	Remarks	Qty	Model
		distributor			
(14)	053 905 261 B	sealing washer for distributor:	8,8A	1	
(14)	021 905 261	sealing washer for distributor:	10	1	
(15)	034 905 265	retaining spring for distributor:	1,1A,1B,2,3	2	
16	026 905 271 A	vacuum unit for distributor:	1,1A,1B	1	
(16)	049 905 271 K	vacuum unit for distributor:	2,3	1	
18	035 905 209 A	screening ring for distributor:	1,2,3,4,5,6	X	
(18)	030 905 209	screening ring for distributor:	1A,4A,8	1	
20	056 905 247 A	gear		1	
20B	049 905 309 A	impulse rotor for distributor:	1,2,3	1	
(21)	034 998 065	hall sender with mounting parts for distributor:	1,1A,2,3	1	
(21)	044 998 065	hall sender with mounting parts for distributor:	1B	1	
(21)	052 998 065	hall sender with mounting parts for distributor:	5	1	
26	035 905 281 A	fill. hd. screw (combi.)	M4X6	2	
27	049 905 281 A	fill. hd. screw (combi.)	M4X8	1	
28	035 905 281 A	fill. hd. screw (combi.)	M4X6	1	

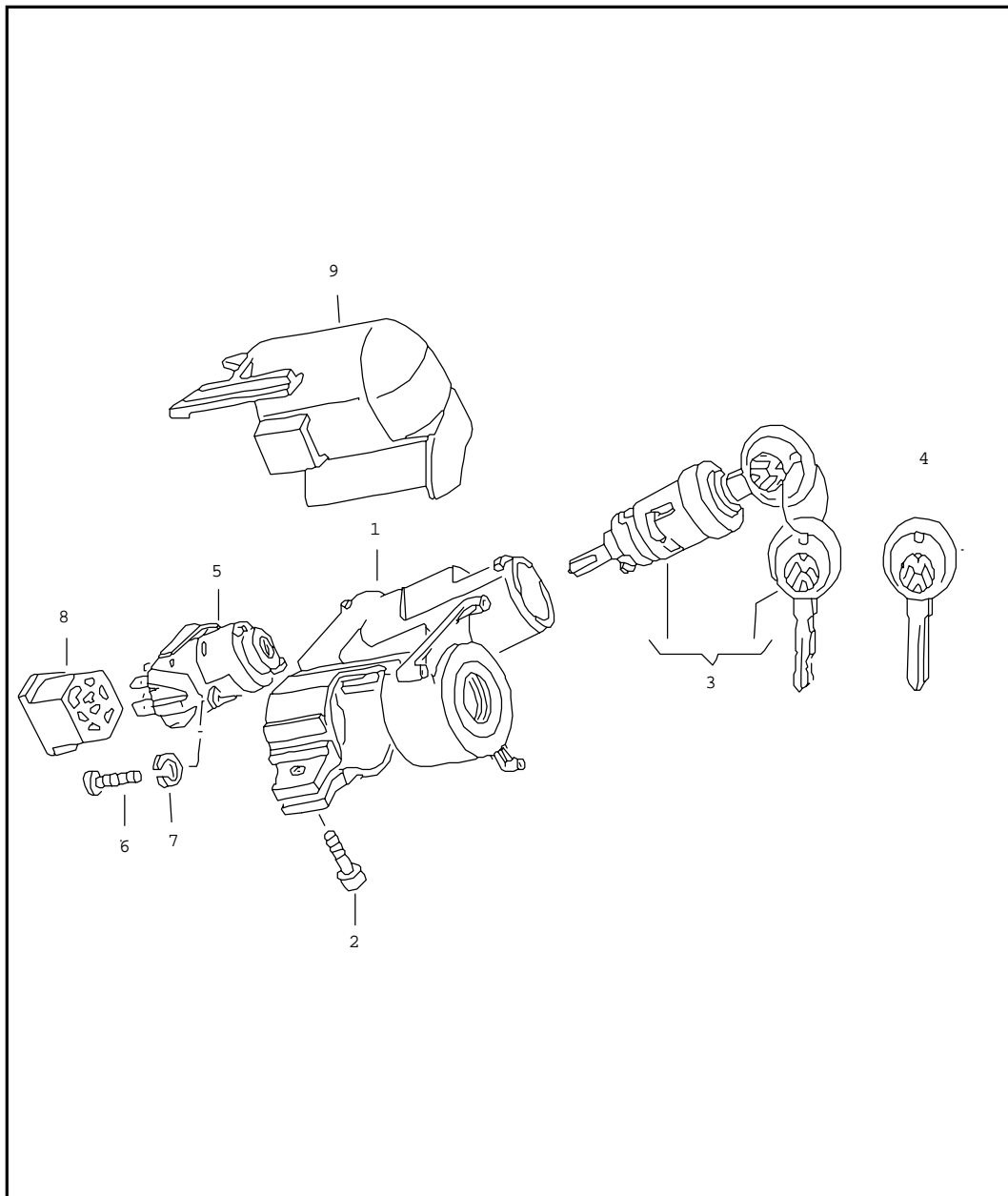

Model	Year	MG	SG	Illustration	VIN No.	Update	16:54	18.02.20100		ETKA	
PA	90	9	05	166-00		336					



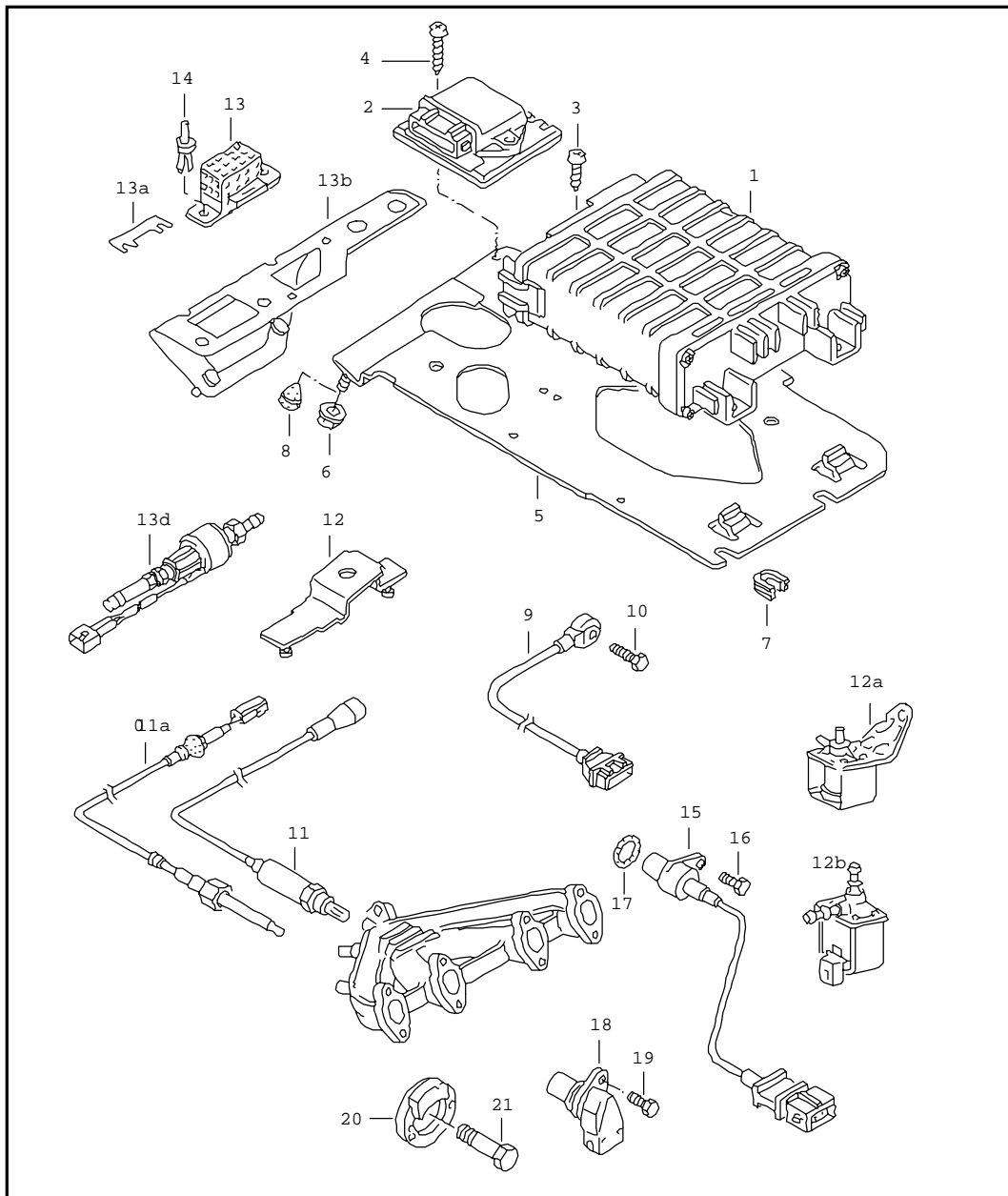

Pos	Part Number	Name	Remarks	Qty	Model
		ignition starter switch steering lock			
1	357 905 851	steering lock without ignition starter switch		1	
2	N 014 739 1	bolt, with hex. socket hd.	M8X16	1	
3	357 905 855 A	lock cylinder for ignition starter switch		1	
4		see illustration:	128		
5	357 905 865	ignition starter switch		1	
6	N 044 115 3	round hd. screw	M3X6	1	
7	N 012 003 2	lock ring	B3	1	
8	357 953 631	flat contact housing	7 pin	1	





Pos	Part Number	Name	Remarks	Qty	Model
		lambda probe with control unit contr. unit for k-jetronic switch unit 'tci' control unit for glow plug			
(1)	037 906 022 DA	electronic control unit	'DIGIFANT'	1	PF
(1)	037 906 022 DK	electronic control unit	'DIGIFANT'	1	automatic: PF
(1)	037 906 022 FL	electronic control unit for vehicles with catalyst	'DIGIFANT'	1	2E
(1)	037 906 022 DG	electronic control unit for vehicles with catalyst	'DIGIFANT'	1	automatic: 2E
(1)	037 906 022 CL	electronic control unit	'DIGIFANT'	1	2E
(1)	037 906 022 DL	electronic control unit	'DIGIFANT'	1	automatic: 2E
(1)	037 906 022 DC	electronic control unit	'DIGIFANT'	1	PB
(1)	037 906 022 CM	electronic control unit	'DIGIFANT'	1	automatic: PB
(1)	021 906 258 AC	electronic control unit	'MOTRONIC'	1	AAA
(1)	893 907 404 M	electronic control unit F >> 31-L-360 000	'KE-MOTRONIC'	1	9A
(1)	8A0 907 404 FA	electronic control unit F 31-L-360 001>> 31-M-340 000	'K-MOTRONIC'	1	9A
(1)	8A0 907 404 CC	electronic control unit F 31-M-340 001>>	'KE-MOTRONIC'	1	9A
(1)	811 907 384 B	control unit for fully electronic ignition		1	KR
(1)	443 907 403 E	electronic control unit >> 31-L-400 000	'MONO- JETRONIC'	1	1F
(1)	443 907 311 E	electronic control unit	'MONO- MOTRONIC'	1	AAM
(1)	443 907 403 G	electronic control unit >> 31-L-400 000	'MONO- JETRONIC'	1	RP
(1)	443 907 311 G	electronic control unit F 31-M-000 001>>	'MONO- MOTRONIC'	1	RP

Model	Year	MG	SG	Illustration	VIN No.	Update	16:54	18.02.20100		ETKA	
PA	90	9	06	166-10		336					

Pos	Part Number	Name	Remarks	Qty	Model	Pos	Part Number	Name	Remarks	Qty	Model
(1)	037 906 022 DA	electronic control unit for vehicles with retro fitted lambda regulated exhaust emission system (conversion : 01/90 >> 12/95)	'DIGIFANT'	1	PB	(2)	867 905 351	final stage 'tsz' F 31-M-240 001>> single parts for: assembly(assy) ignition transformer see illustration:	6 pin 701 905 104 A 'TSZ' 164	1	EZ
(1)	321 906 263 B	control unit for lambda probe for vehicles with retro fitted lambda regulated exhaust emission system (conversion : 01/90 >> 12/95)		1	KR	(2)	357 905 352	final stage 'tsz' single parts for: assembly(assy) ignition transformer see illustration:	3 pin 357 905 104 'TSZ' 164	1	AAA
-	191 971 149 B	loom for electr. control unit for vehicles with retro fitted lambda regulated exhaust emission system (conversion : 01/90 >> 12/95)		1	PB	(2)	867 905 352	final stage 'tsz' F 31-M-000 001>> single parts for: assembly(assy) ignition transformer see illustration:	3 pin 867 905 104A/B 'TSZ' 164	1 1	2E AAM,RP
-	191 971 130	loom for lambda probe for vehicles with retro fitted lambda regulated exhaust emission system (conversion : 01/90 >> 12/95)		1	KR	3	N 013 970 5	tapping screw, fill. hd.	B4,8X9,5	3	
-	191 906 102	protective cap terminal pin housing for vehicles with retro fitted lambda regulated exhaust emission system (conversion : 01/90 >> 12/95)	5 pin	X	PB	4	N 013 971 3	tapping screw, fill. hd.	B4,8X22	2	
-	443 906 233	flat contact housing for vehicles with retro fitted lambda regulated exhaust emission system (conversion : 01/90 >> 12/95)	3 pin	1	PB	4	N 013 971 3	tapping screw, fill. hd.	B4,8X22	2	
-	443 906 233	flat contact housing for vehicles with retro fitted lambda regulated exhaust emission system (conversion : 01/90 >> 12/95)	3 pin	1	PB	5	357 906 324	holder for electr. contr. unit F >> 31-L-400 000	lhd	1	
-	443 906 233	flat contact housing for vehicles with retro fitted lambda regulated exhaust emission system (conversion : 01/90 >> 12/95)	3 pin	1	PB	(5)	357 906 329	holder for electr. contr. unit F 31-M-000 001>>	lhd	1	
-	357 972 741 A	single wiring seal for wire cross section: for vehicles with retro fitted lambda regulated exhaust emission system (conversion : 01/90 >> 12/95)	5,6X7,8 red 1,5	1	PB	(5)	358 906 325	holder for electr. contr. unit F >> 31-L-400 000	rhd	1	
2	191 905 351 B	switch unit 'tci'	TELEFUNKEN	1		(5)	358 906 329	holder for electr. contr. unit F 31-M-000 001>>	rhd	1	
2	191 905 351 B	switch unit 'tci' F >> 31-M-240 000	7 pin TELEFUNKEN	1	EZ	(6)	171 201 969	shouldered hex. nut	lhd	1	
						7	191 906 276	clip		2	
						8	N 020 029 1	plug	B7X0,8X14	1	RA
						(9)	054 905 377	anti-knock sensor	blue also use: 000 979 133 A	1 3	2E
						(9)	054 905 377 A	anti-knock sensor	green also use: 000 979 133 A	2 6	9A
						(9)	054 905 377 A	anti-knock sensor	green also use: 000 979 133 A	1 3	PF,PB

Model	Year	MG	SG	Illustration	VIN No.	Update	16:54	18.02.20100		ETKA	
PA	90	9	06	166-10		336					

Pos	Part Number	Name	Remarks	Qty	Model	Pos	Part Number	Name	Remarks	Qty	Model
(9)	021 905 377	anti-knock sensor	white	1	AAA	-	049 906 267	valve for lambda probe for vehicles with retro fitted lambda regulated exhaust emission system (conversion : 01/90 >> 12/95)		1	KR
(9)	037 905 377 A	anti-knock sensor		1	AAA						
10	N 010 233 6	screw, hexagonal head	M8X28	2							
11	035 906 265 B	lambda probe F >> 31-L-300 000		1	RP,1F	-	049 906 267	valve for lambda probe for vehicles with retro fitted lambda regulated exhaust emission system (conversion : 01/90 >> 12/95)		1	KR
(11)	051 906 265 C	lambda probe F 31-L-300 001>>		1	RP,1F,AAM						
(11)	051 906 265 D	lambda probe for vehicles without catalyst F >> 31-L-400 000		1	RP	-	049 906 269	clip for vehicles with retro fitted lambda regulated exhaust emission system (conversion : 01/90 >> 12/95)		1	KR
(11)	051 906 265 D	lambda probe for vehicles without catalyst F >> 31-L-400 000		1	RP	-	049 906 273	bush for vehicles with retro fitted lambda regulated exhaust emission system (conversion : 01/90 >> 12/95)		1	KR
(11)	030 906 265 M	lambda probe for vehicles without catalyst F 31-M-000 001>>		1	RP	11A	192 906 088	temperature sensor		1	"J..":9A
(11)	034 906 265 C	lambda probe F >> 31-L-400 000	lhd	1	9A	12	357 906 393	retaining bracket		1	PF,PB
(11)	034 906 265 C	lambda probe for vehicles with retro fitted lambda regulated exhaust emission system (conversion : 01/90 >> 12/95)		1	KR	-	357 957 861	grommet	28/6,4	1	
(11)	030 906 265 K	lambda probe F 31-M-000 001>>	lhd	1	9A	12A	437 906 283 A	two-way valve		1	air condit.
(11)	030 906 265 K	lambda probe	rhd	1	9A	12B	028 906 283	change-over valve		1	diesel eng.: AAZ air condit.
(11)	030 906 265	lambda probe		1	PF	13	191 911 261 A	control unit for glow plug		1	RA,SB,1Y
(11)	030 906 265	lambda probe for vehicles with retro fitted lambda regulated exhaust emission system (conversion : 01/90 >> 12/95)		1	PB	13A	N 017 125 1	fuse	B50	1	
(11)	030 906 265 K	lambda probe		1	2E automatic: AAM,RP	14	357 911 269	clip		2	RA,SB,1Y
(11)	021 906 265 A	lambda probe for vehicles with regulated catalyst		1	AAA	-	191 906 283 A	electro change-over valve	'EGR'	1	diesel eng.: AAZ
						15	021 906 433 A	sender for engine speed		1	AAA
						16	N 090 358 2	bolt, with hex. socket hd. (combi.)	M6X12	1	AAA
						17	021 906 445	sealing washer		1	AAA
						17	021 906 445	sealing washer		1	AAA

Model	Year	MG	SG	Illustration	VIN No.	Update	16:55	18.02.20100		ETKA	
PA	90	9	06	166-20		336					

206

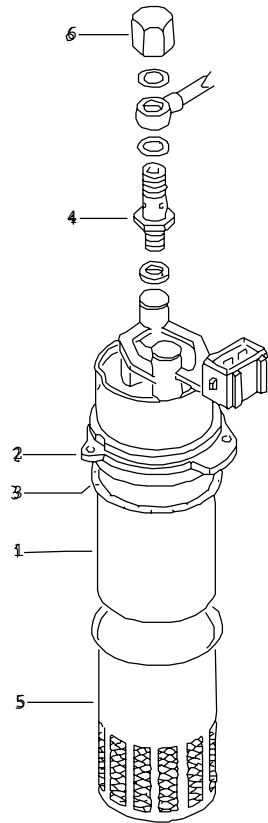

EP 78 1 88

Pos	Part Number	Name	Remarks	Qty	Model
		fuel pump			KR,9A
1	191 906 091 H	fuel pump	60MM	1	
2	191 201 792	clamping ring		1	
3	N 902 238 02	seal	59X5,3-N	1	
4	893 906 093	check valve		1	
5	191 201 531	strainer		1	
6	N 011 069 1	cap nut	M12X1,5	1	

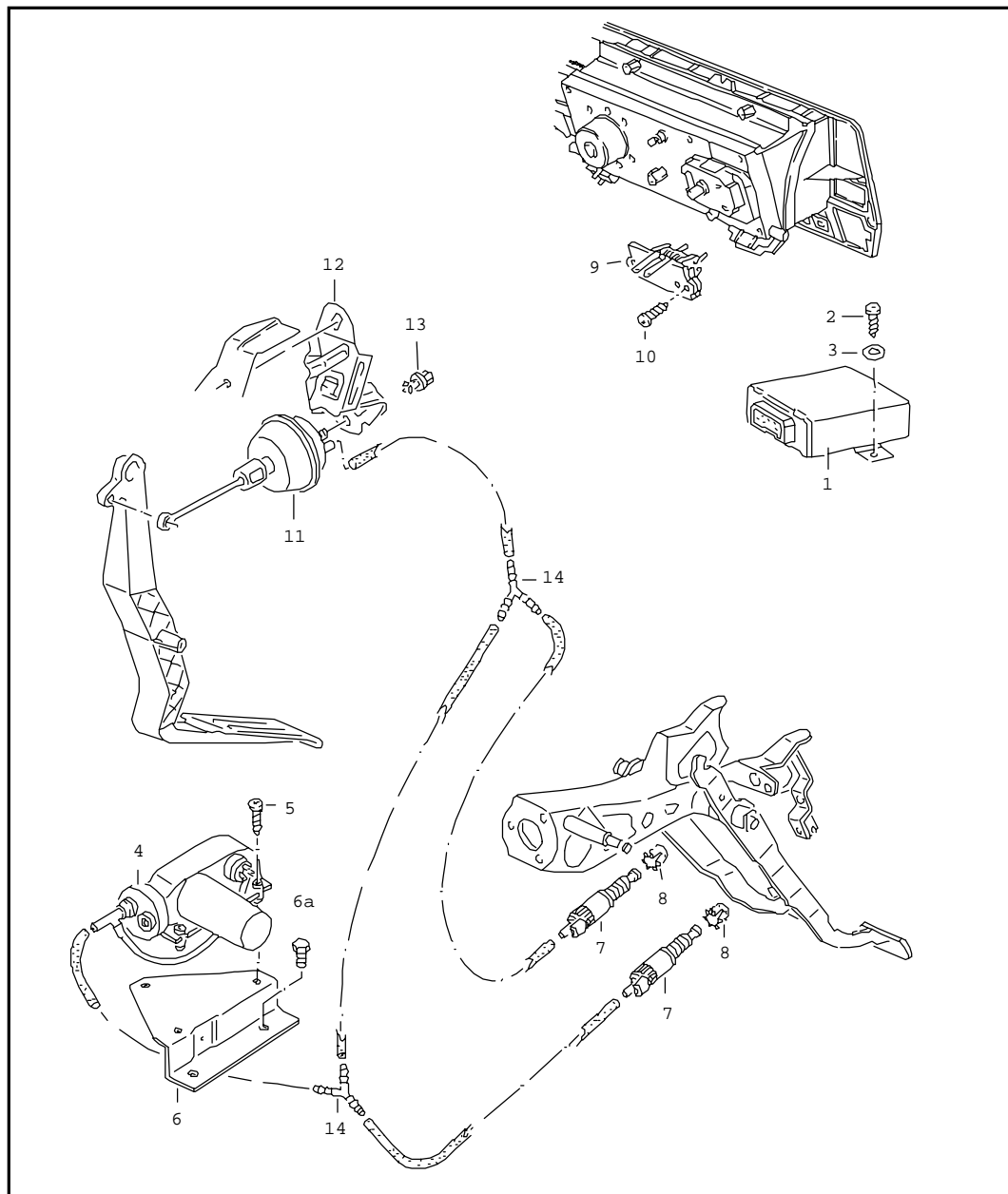



Pos	Part Number	Name	Remarks	Qty	Model
		cruise control system			
1	443 907 305 A	speed regulator		1	
2	N 013 968 1	tapping screw, fill. hd.	ST4,8X13-C	2	
3	N 011 512 2	washer	5,5X10X1	2	
(4)	701 907 325	vacuum pump		1	
5	N 013 975 6	tapping screw, fill. hd.	B4,8X19	3	
(6)	357 907 341	bracket vacuum pump		1	
6A	N 010 210 7	screw, hexagonal head	M6X10K	2	
7	811 907 343 B	ventilation valve		2	manual gearbox automatic
8	431 721 283 B	clip	13	2	
9	357 907 345 A	hall sender		1	
10	N 013 951 2	tapping screw, fill. hd.	BZ2,2X9,5	2	
11	357 907 327	throttle control element		1	lhd
(11)	358 907 327	throttle control element		1	rhd
12		see illustration:	98		
13	357 907 519	adjusting nut		1	
14	058 127 561	y-piece		2	
-	N 018 046 3	hose in coils of 5m 'order unit 5'	5X2,5	*	

starter versions

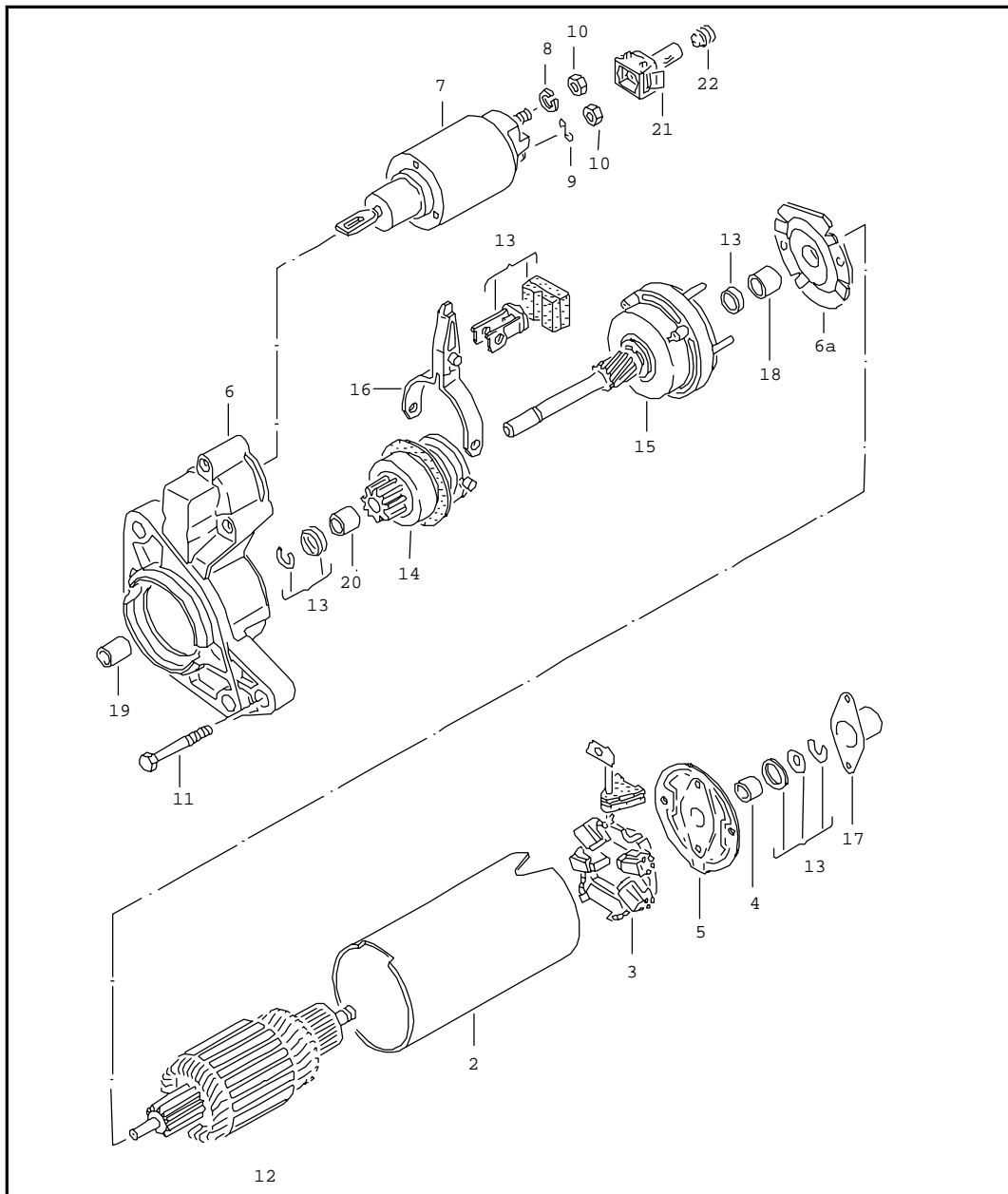

1	>02A 911 023	BOSCH		RF, EZ	02A 911 023 #02A 911 023 X #02A 911 023 V
2	>02A 911 023 A	BOSCH	>>31-L400000	PF, PB, RP, 1F	02A 911 023 E #02A 911 023 EX #02A 911 023 EV
3	>02A 911 023 B	BOSCH also use see no.: 6		diesel eng. RA, SB, 1Y, AA	02A 911 023 J #02A 911 023 GX #02A 911 023 GV
4	>02A 911 023 D	BOSCH	>>31-L400000	9A, KR, 2E	02A 911 023 E #02A 911 023 EX #02A 911 023 EV
5	>02A 911 023 C	BOSCH also use see no.: 6		AAA	02A 911 023 H #02A 911 023 HX #02A 911 023 HV
6	>068 911 023 G	BOSCH		automatic: AAA diesel eng. automatic: 1Y, AAZ	020 911 023 D +357 972 771 +357 972 742 C +N 904 220 02 #068 911 023 TX +357 972 771 +357 972 742 C +N 904 220 02 #068 911 023 TV +357 972 771 +357 972 742 C +N 904 220 02





Pos	Part Number	Name	Remarks	Qty	Model
		starter and single parts	BOSCH		
1	>02A 911 023	starter	12V/0,9KW	1	
(1)	#02A 911 023 X	starter		1	
(1)	#02A 911 023 V	starter		1	
(1)	>02A 911 023 E	starter		1	
(1)	#02A 911 023 EX	starter		1	
(1)	#02A 911 023 EV	starter		1	
(1)	>02A 911 023 J	starter		1	
(1)	#02A 911 023 GX	starter		1	
(1)	#02A 911 023 GV	starter		1	
(1)	>020 911 023 D	starter		1	
(1)	#068 911 023 TX	starter		1	
(1)	#068 911 023 TV	starter		1	
(1)	>020 911 023	starter		1	
(1)	#055 911 023 MX	starter		1	
(1)	#020 911 023 AV	starter		1	
(1)	#055 911 023 JX	starter		1	
(1)	#020 911 023 AV	starter		1	
(1)	#020 911 023 AX	starter		1	
(1)	#020 911 023 AV	starter		1	
(1)	>02A 911 023 H	starter		1	
(1)	#02A 911 023 HX	starter		1	
(1)	#02A 911 023 HV	starter		1	

Model	Year	MG	SG	Illustration	VIN No.	Update	19:24	18.02.20100		ETKA	
PA	90	9	11	167-00		336					



Pos	Part Number	Name	Remarks	Qty	Model
		starter and single parts	BOSCH		
(1)	#02A 911 023 HV	starter		1	
2	02A 911 115	field coil	for starter: 1	1	
(2)	02A 911 115 A	field coil	for starter: 4,8	1	
(2)	02B 911 115	field coil	for starter: 9,10	1	
(2)	021 911 115	field coil	for starter: 5	1	
(2)	055 911 115 D	field coil	for starter: 2,7	1	
(2)	068 911 115 H	field coil	for starter: 3,6	1	
3	02A 911 209	brush holder plate	for starter: 1,2,7	1	
(3)	02B 911 209	brush holder plate	for starter: 9,10	1	
(3)	021 911 209	brush holder plate	for starter: 3,5,6	1	
(3)	035 911 209 E	brush holder plate	for starter: 4,8	1	
4	026 911 213	bush	for starter: 1,2,7	1	
(4)	035 911 213 B	bush	for starter: 3-6,8-10	1	
5	055 911 211	commutator bearing housing	for starter: 1,2,7	1	
(5)	02A 911 211	commutator bearing housing	for starter: 4,8-10	1	

Model	Year	MG	SG	Illustration	VIN No.	Update	19:24	18.02.20100		ETKA	
PA	90	9	11	167-00		336					



Pos	Part Number	Name	Remarks	Qty	Model
		starter and single parts	BOSCH		
(5)	02A 911 211	commutator bearing housing for starter:	4,8-10	1	
(5)	068 911 211 A	commutator bearing housing for starter:	3,5,6	1	
6	02A 911 255	starter drive housing for starter:	1,2	1	
(6)	02A 911 255 A	starter drive housing for starter:	4	1	
(6)	02A 911 255 B	starter drive housing for starter:	3	1	
(6)	02A 911 255 C	starter drive housing for starter:	9	1	
(6)	020 911 255	starter drive housing for starter:	10	1	
(6)	020 911 255 A	starter drive housing for starter:	6	1	
(6)	021 911 255	starter drive housing for starter:	5	1	
(6)	055 911 255 C	starter drive housing for starter:	7	1	
(6)	055 911 255 G	starter drive housing for starter:	8	1	
6A	026 911 255 A	intermediate plate for starter:	1,2,7	1	
(7)	026 911 287	solenoid switch for starter:	2,4,7-10	1	

Model	Year	MG	SG	Illustration	VIN No.	Update	19:25	18.02.20100		ETKA	
PA	90	9	11	167-00		336					



Pos	Part Number	Name	Remarks	Qty	Model
		starter and single parts	BOSCH		
7	085 911 287	solenoid switch		1	
		for starter:	1,3,5,6		
		also use:	357 972 771	1	
			357 972 742 C	1	
			N 904 220 02	1	
-	035 911 299	screw, csk. hd.	M5X33	3	
8	N 012 038 7	lock ring	8	1	
9	N 012 229 3	spring washer	A8X15X0,5	1	
10	N 011 008 8	hex. nut	M8	2	
11	N 101 035 01	screw, hexagonal head	M10X160	1	
(11)	N 905 729 01	double hex. hd. bolt	BM10X160/M8X15	1	
(11)	N 904 359 01	screw, cheese hd.	M10X190	2	automatic
(11)	035 911 299	screw, csk. hd.		3	
		for starter:	6		
(12)	02A 911 311 A	armature		1	
		for starter:	2		
12	02A 911 311 B	armature		1	
		for starter:	1		
(12)	021 911 311 B	armature		1	
		for starter:	4,8		
(12)	053 911 311	armature		1	
		for starter:	9,10		
(12)	055 911 311 G	armature		1	
		for starter:	7		
(12)	068 911 311 H	armature		1	
		for starter:	3,5,6		
13	026 911 320	repair kit for starter	1,2,7	1	

Model	Year	MG	SG	Illustration	VIN No.	Update	19:25	18.02.20100		ETKA	
PA	90	9	11	167-00		336					

Pos	Part Number	Name	Remarks	Qty	Model
		starter and single parts	BOSCH		
(13)	035 911 320 A	repair kit for starter	3-6,8-10	1	
14	02A 911 335	freewheel unit	for starter: 1,2	1	
(14)	02A 911 335 A	freewheel unit	for starter: 4	1	
(14)	02A 911 335 C	freewheel unit	for starter: 9	1	
(14)	02A 911 335 D	freewheel unit	for starter: 3	1	
(14)	020 911 335 A	freewheel unit	for starter: 10	1	
(14)	021 911 335	freewheel unit	for starter: 5	1	
(14)	055 911 335 F	freewheel unit	for starter: 7	1	
(14)	055 911 335 J	freewheel unit	for starter: 8	1	
(14)	068 911 303 B	1 set of planetary gears with drive	for starter: 6	1	
(15)	02A 911 303	planetary gear	for starter: 4	1	
(15)	02A 911 303 A	planetary gear	for starter: 9	1	
(15)	020 911 303	planetary gear	for starter: 10	1	
(15)	021 911 303	planetary gear	for starter: 5	1	

Model	Year	MG	SG	Illustration	VIN No.	Update	19:25	18.02.20100		ETKA	
PA	90	9	11	167-00		336					

Pos	Part Number	Name	Remarks	Qty	Model
		starter and single parts	BOSCH		
(15)	055 911 303 G	planetary gear for starter:	8	1	
15	068 911 303 A	planetary gear for starter:	3	1	
16	085 911 365	engaging lever		1	
17	026 911 495	cap for starter:	1,2	1	
(17)	035 911 495 C	cap for starter:	3-6,8-10	1	
18	049 911 257	bush for starter:	1,2,7	1	
19	014 301 155	bush for starter:	1-5,9	1	
(19)	113 301 155	bush for starter:	6-8,10	1	
20	02B 911 213	bush for starter:	1-4,7-10	1	
21	357 972 771	flat contact housing	1 pin	1	
22	357 972 742 C	single wiring seal for wire cross section:	9,0X7,8 green 4,0	1	
-	N 904 220 02	flat contact	6,3-4	1	
-	068 911 145	screw, cheese hd.		2	
-	N 904 030 01	cap	13X14	1	

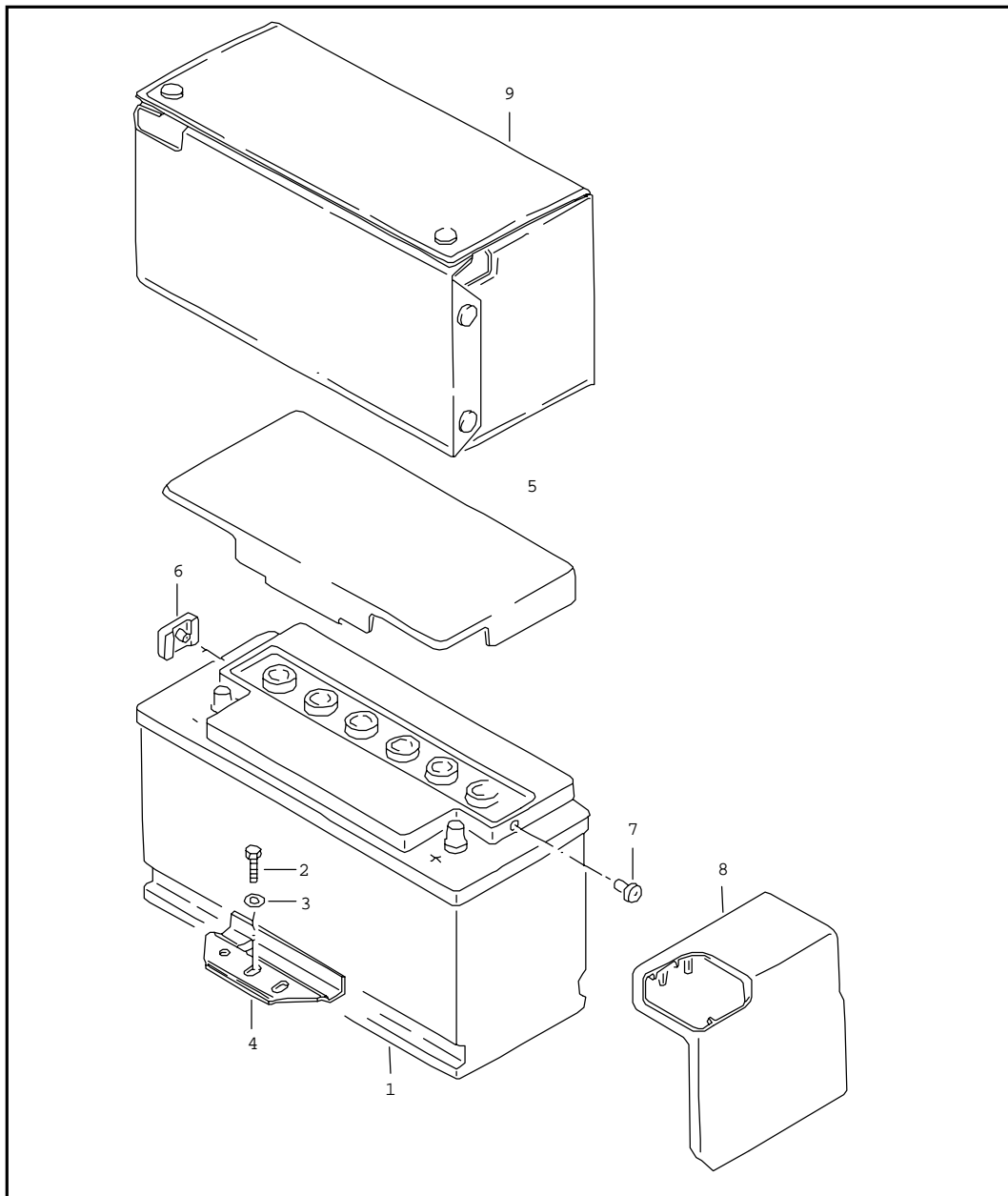

Model	Year	MG	SG	Illustration	VIN No.	Update	16:57	18.02.20100		ETKA	
PA	90	9	15	167-30		336					



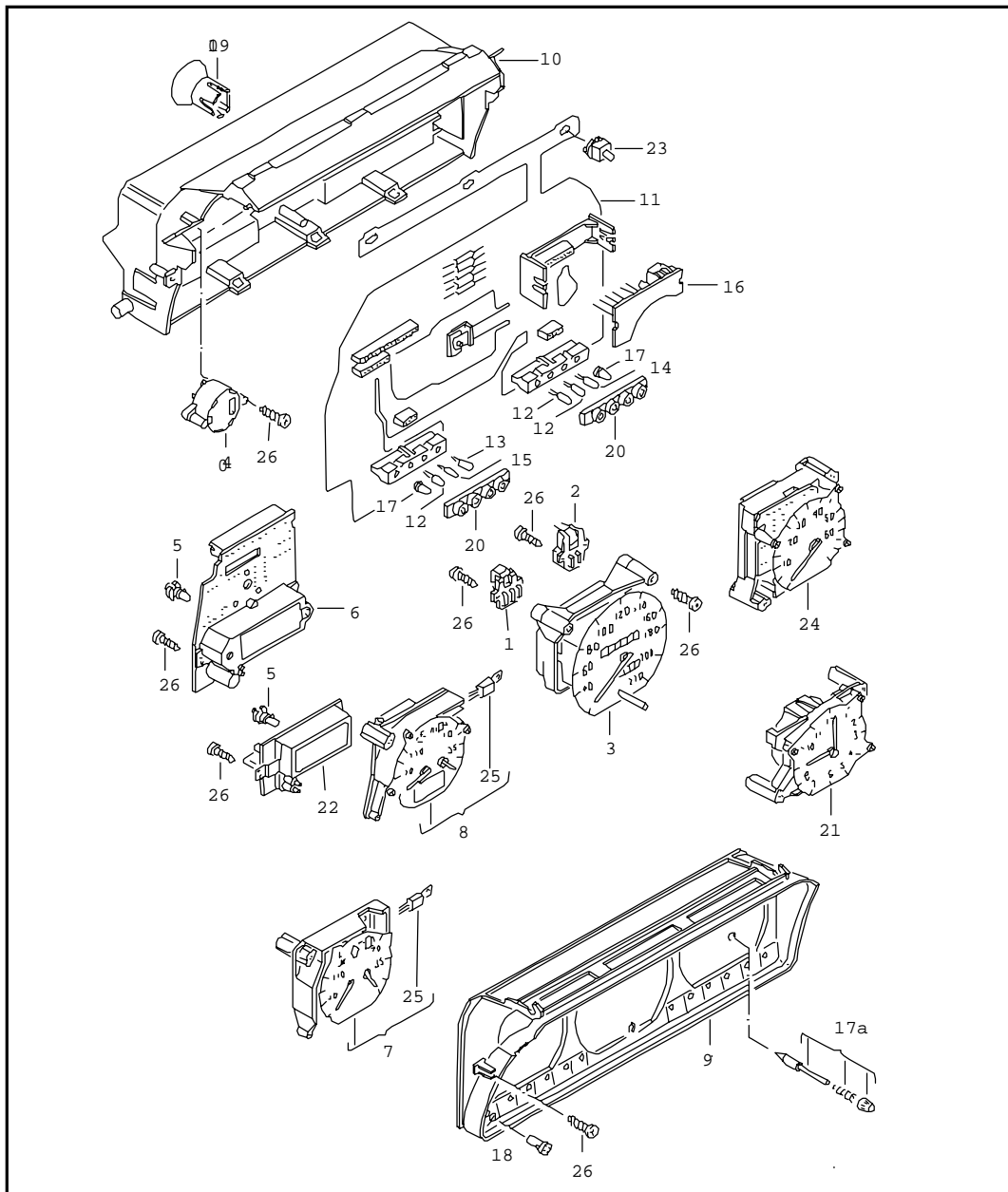

Pos	Part Number	Name	Remarks	Qty	Model
		battery mounting			
		battery			
1	191 915 105 A	battery	36AH/175A	1	
(1)	191 915 105 E	battery	45AH/220A	1	
(1)	191 915 105 H	battery	54AH/265A	1	
(1)	191 915 105 M	battery	63AH/300A	1	
(1)	191 915 105 Q	battery	64AH/380A	1	
(1)	357 915 105 B	battery	88AH/395A	1	
2	N 010 233 6	screw, hexagonal head	M8X28	1	
3	N 011 558 11	washer	8,4X15X1,6	1	
4	171 803 219	clamping strip for battery		1	
5	191 915 411	cover for battery	36AH	X	
(5)	281 915 411 F	cover for battery	45,50AH	X	
(5)	281 915 411 G	cover for battery	54,63,64AH	X	
(5)	281 915 411 C	cover for battery	88AH	X	
6	191 915 505	adapter - breather		1	
7	251 915 505	plug		1	
8	357 915 411	cover for battery		1	air condit.
9	357 915 411 A	battery protection cover	54,63AH	1	
(9)	357 915 411 B	battery protection cover	60AH	1	
-	191 998 015	repair kit battery		1	





Pos	Part Number	Name	Remarks	Qty	Model
-	357 919 033 AE	instrument housing and components F >> 31-L-400 000			
1	357 907 345 A	combi instrument with revolution counter for service installation 1.6-1.8ltr. carb. engine fuel injection engine	220 KMh-W 920	1	
1	357 907 345 A	hall sender for volume control cruise control system multi function indicator		1	RADIO
2	---	discontinued / replacement:	357 907 345 A	1	
3		speedometer	see illustration:	185,185-20	
(4)	357 907 346	sender - vacuum for vehicles with multi function indicator	1,2 BAR	1	KE-MOTRONIC/ 16V:9A K-JETRONIC/ 16V:KR DIGIFANT: PF,PB
4	357 907 346 A	sender - vacuum for vehicles with multi function indicator	1,2 BAR	1	MOTOMETER KE-MOTRONIC/ 16V:9A K-JETRONIC/ 16V:KR DIGIFANT: PF,PB
5	893 919 040	bulb with black base digital clock multi function indicator	12V1,2W	1	
6	357 919 044 AA	multi function indicator	KMh/C/LTR 014-BH	1	VDO DIGIFANT: PF
(6)	357 919 044 BA	multi function indicator	KMh/C/LTR 014-BH	1	MOTOMETER DIGIFANT: PF
(6)	357 919 044 AB	multi function indicator	KMh/C/LTR 123-BB	1	VDO DIGIFANT: PB
(6)	357 919 044 BB	multi function indicator	KMh/C/LTR 123-BB	1	MOTOMETER DIGIFANT: PB

Model	Year	MG	SG	Illustration	VIN No.	Update	16:57	18.02.20100		ETKA	
PA	90	9	19	168-00		336					

Pos	Part Number	Name	Remarks	Qty	Model	Pos	Part Number	Name	Remarks	Qty	Model
(6)	357 919 044 AC	multi function indicator	VDO KMH/C/LTR 107-AK	1	K-JETRONIC/ 16V:KR	(6)	357 919 044 AN	multi function indicator	VDO KMH/C/LTR 022-AJ	1	MONOJET:RP
(6)	357 919 044 BC	multi function indicator	MOTOMETER KMH/C/LTR 107-AK	1	K-JETRONIC/ 16V:KR	(6)	357 919 044 BN	multi function indicator	MOTOMETER KMH/C/LTR 022-AJ	1	MONOJET:RP
(6)	357 919 044 AD	multi function indicator	VDO MPH/C/GAL 107-AL	1	"GB." / K-JETRONIC/ 16V:KR	(6)	357 919 044 AP	multi function indicator	VDO KMH/C/LTR 029-BD	1	DIGIFANT:2E
(6)	357 919 044 BD	multi function indicator	MOTOMETER MPH/C/GAL 107-AL	1	"GB." / K-JETRONIC/ 16V:KR	(6)	357 919 044 BP	multi function indicator	MOTOMETER KMH(C/LTR 029-BD	1	DIGIFANT:2E
(6)	357 919 044 AE	multi function indicator	VDO MPH/C/GAL 123-BC	1	"GB." / DIGIFANT: PB	(6)	357 919 044 AQ	multi function indicator	VDO MPH/C/GAL 029-BE	1	"GB." / DIGIFANT:2E
(6)	357 919 044 BE	multi function indicator	MOTOMETER MPH/C/GAL 123-BC	1	"GB." / DIGIFANT: PB	(6)	357 919 044 BQ	multi function indicator	MOTOMETER MPH/C/GAL 029-BE	1	"GB." / DIGIFANT:2E
(6)	357 919 044 AF	multi function indicator	VDO KMH/C/LTR 013-AG	1	KE-MOTRONIC/ 16V:9A	7	357 919 045 D	fuel and temperature gauge for vehicles with analog clock	0-35-70-LTR/ 70-110-130C ANALOG	1	
(6)	357 919 044 BF	multi function indicator	MOTOMETER KMH/C/LTR 013-AG	1	KE-MOTRONIC/ 16V:9A	(7)	357 919 045 E	fuel and temperature gauge for vehicles with analog clock	0-8-15-GAL/ 70-110-130C ANALOG	1	"GB."
(6)	357 919 044 AH	multi function indicator	VDO MPH/C/GAL 013-BJ	1	"GB." / KE-MOTRONIC/ 16V:9A	8	357 919 045 F	fuel and temperature gauge for vehicles with revolution counter	0-35-70-LTR/ 70-110-130C	1	
(6)	357 919 044 BH	multi function indicator	MOTOMETER MPH/C/GAL 013-BJ	1	"GB." / KE-MOTRONIC/ 16V:9A	(8)	357 919 045 G	fuel and temperature gauge for vehicles with revolution counter	0-8-15-GAL/ 70-110-130C	1	"GB."
(6)	357 919 044 AL	multi function indicator	VDO MPH/C/GAL 014-BL	1	"GB." / DIGIFANT: PF	9	357 919 053	instrument housing for vehicles with analog clock	ANALOG	1	
(6)	357 919 044 BL	multi function indicator	MOTOMETER MPH/C/GAL 014-BL	1	"GB." / DIGIFANT: PF	(9)	357 919 053 B	instrument housing for vehicles with revolution counter		1	
(6)	357 919 044 AM	multi function indicator	VDO MPH/C/GAL 022-BV	1	"GB." / MONOJET:RP	(9)	357 919 053 D	instrument housing for vehicles with revolution counter		1	"J.."
(6)	357 919 044 BM	multi function indicator	MOTOMETER MPH/C/GAL 022-BV	1	"GB." / MONOJET:RP	10	357 919 054	instrument housing	rear	1	



Model	Year	MG	SG	Illustration	VIN No.	Update	16:57	18.02.20100		ETKA	
PA	90	9	19	168-00		336					

Pos	Part Number	Name	Remarks	Qty	Model	Pos	Part Number	Name	Remarks	Qty	Model
(10)	357 919 054 A	instrument housing for vehicles with multi function indicator	rear	1		24	357 919 253	rev counter with control unit (printed circ.) for oil pressure warning lamp	7000 U/MIN	1	4 cylinder
11	357 919 059	printed circuit foil for vehicles with analog clock	ANALOG	1		(24)	357 919 253 A	rev counter with control unit (printed circ.) for oil pressure warning lamp	8000 U/MIN	1	4-cylinder/ 16V:KR
(11)	357 919 059 A	printed circuit foil for vehicles with revolution counter		1		(24)	357 919 253 B	rev counter with control unit (printed circ.) for oil pressure warning lamp	5500 U/MIN	1	diesel eng.
12	171 919 061 B	light emitting diode	red	X		(24)	357 919 253 C	rev counter with control unit (printed circ.) for oil pressure warning lamp	7000 U/MIN	1	6 cylinder
13	171 919 061 C	light emitting diode	green	X		25	357 919 803	voltage regulator		1	
14	171 919 061 D	light emitting diode	yellow	X		26	357 998 089	set of screws instrument housing		1	
15	867 919 062	bulb with blue cap		1							
16	357 919 064	electr. control unit (printed circ.)for oil press.warn.light for vehicles with analog clock	ANALOG	1	4 cylinder						
(16)	357 919 064 A	electr. control unit (printed circ.)for oil press.warn.light for vehicles with analog clock	ANALOG	1	diesel eng.						
(16)	357 919 064 B	electr. control unit (printed circ.)for oil press.warn.light for vehicles with analog clock	ANALOG	1	6 cylinder						
(16)		electr. control unit (printed circ.)for oil press.warn.light for vehicles with revolution counter see no.:	24								
17	251 919 068	cap		X							
17A		not a spare part									
18	357 919 074	cap for vehicles with multi function indicator		1							
19	357 919 075	seat see illustration:	185,185-20-40	1							
20	357 919 077	holder - light emitting diode		2							
21	357 919 201	clock	ANALOG	1							
22	357 919 203	digital clock	24H	1							
23	357 919 243 B	bulb with blue base for dashboard lighting	12V1,8W	3							

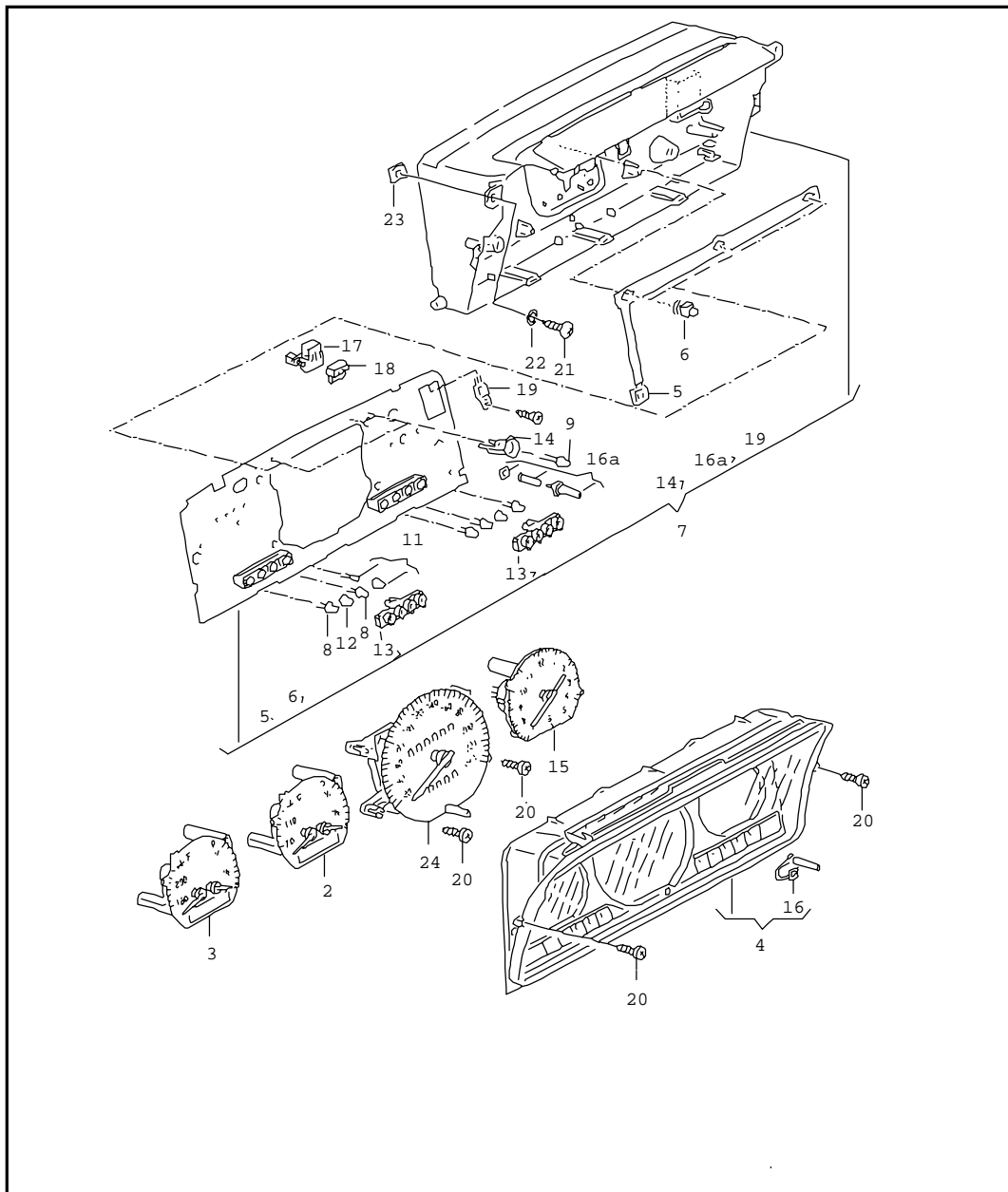

Model	Year	MG	SG	Illustration	VIN No.	Update	16:57	18.02.20100		ETKA	
PA	90	9	19	168-10		336					



Pos	Part Number	Name	Remarks	Qty	Model
		instrument housing and components for vehicles with analog clock F 31-M-000 001>>			
2	357 919 045 J	fuel and temperature gauge	0-35-70-LTR 70-110-130C	1	
3	357 919 045 K	fuel and temperature gauge	0-8-15-GAL 70-110-130C	1	"GB."
4	357 919 053 E	instrument housing		1	
5	357 919 059 AA	printed circuit foil for instrument lighting		1	
6	357 919 243 B	bulb with blue base for dashboard lighting	12V1,8W	3	
7	701 919 059 AD	printed circuit with housing		1	
(7)	357 919 059 AC	printed circuit with housing	I=1:2,23	1	diesel eng.
(7)	357 919 059 AD	printed circuit with housing for vehicles with ribbed v-belt	I=1:3,00	1	diesel eng.
8	357 919 061	light emitting diode	red	X	
9	357 919 061 A	light emitting diode	green	X	
10	867 919 061	light emitting diode	yellow	X	
11	357 919 062	bulb with blue cap		1	
12	251 919 068	cap		X	
13	357 919 077	holder - light emitting diode		2	
14	357 919 077 A	holder - light emitting diode turn signal	MOTOMETER	2	
14	357 919 077 B	holder - light emitting diode turn signal	VDO	2	
15	357 919 201 A	clock	ANALOG	1	
16	357 919 070	setting knob for large clock		1	
16A		not a spare part			



Model	Year	MG	SG	Illustration	VIN No.	Update	16:57	18.02.20100		ETKA	
PA	90	9	19	168-10		336					

Pos	Part Number	Name	Remarks	Qty	Model	Pos	Part Number	Name	Remarks	Qty	Model
17	357 907 345 A	hall sender for volume control radio cruise control system and/or shift mechanism 4 speed automatic gearbox	SHIFTLOCK	X							
18	357 907 359	contact plate		X							
19	357 919 803	voltage regulator		1							
20	357 998 089	set of screws instrument housing		1							
21	N 013 950 2	tapping screw, fill. hd.	B3,5X19	2							
22	N 011 554 3	washer	3,7X7X0,5	2							
23	N 902 764 02	speed nut	3,1X16,5X11	2							
24		speedometer with kilometre trip recorder see illustration:	185-10								

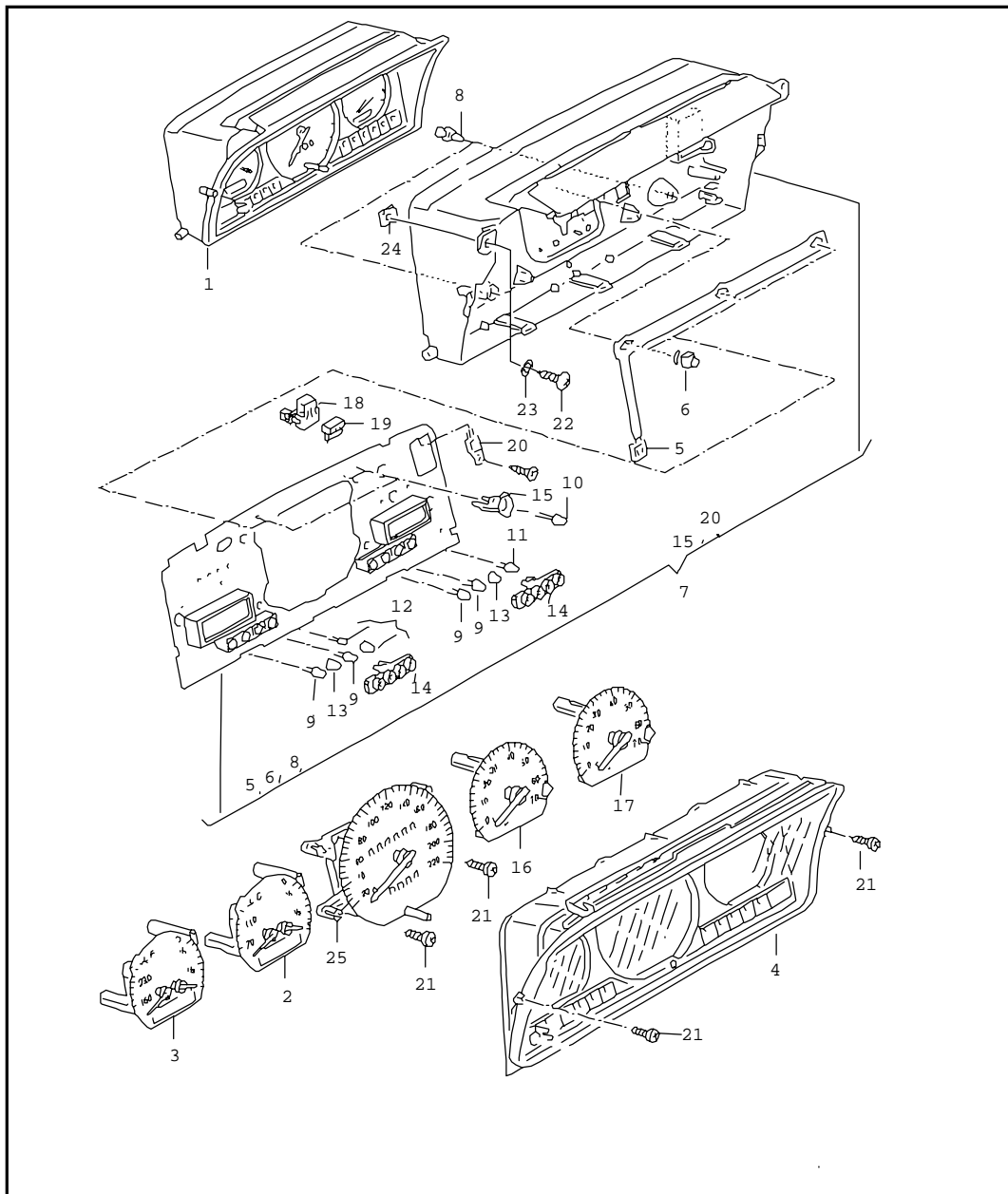

Model	Year	MG	SG	Illustration	VIN No.	Update	16:58	18.02.20100		ETKA	
PA	90	9	19	168-20		336					



Pos	Part Number	Name	Remarks	Qty	Model
(1)	357 919 033 GJ	instrument housing and components for vehicles with revolution counter F 31-M-000 001>>			
		combi instrument	260 KMh-W 920	1	
		with:			
		revolution counter	220 KMh-W 920		
		for service installation	240 KMh-W 920		
		use for:	diesel eng.		
		not for:			
2	357 919 045 L	fuel and temperature gauge	0-35-70-LTR 70-110-130C	1	
(2)	357 919 045 M	fuel and temperature gauge	0-8-15-GAL 70-110-130C	1	"GB."
4	357 919 053 F	instrument housing		1	
5	357 919 059 AA	printed circuit foil for instrument lighting		1	
6	357 919 243 B	bulb with blue base for dashboard lighting	12V1,8W	3	
7	357 919 059 BA	printed circuit with housing for vehicles with revolution counter	7000 U/MIN	1	
		with:	24H		
(7)	357 919 059 BB	printed circuit with housing for vehicles with revolution counter	8000 U/MIN	1	
		with:	24H		
(7)	357 919 059 BC	printed circuit with housing for vehicles with revolution counter	I=1:2,23	1	diesel eng.
		with:	5500 U/MIN		
		digital clock	24H		
(7)	357 919 059 BC	printed circuit with housing for vehicles with revolution counter	I=1:2,23	1	diesel eng.
		with:	5500 U/MIN		
		digital clock	24H		



Model	Year	MG	SG	Illustration	VIN No.	Update	16:58	18.02.20100		ETKA	
PA	90	9	19	168-20		336					

Pos	Part Number	Name	Remarks	Qty	Model	Pos	Part Number	Name	Remarks	Qty	Model
(7)	357 919 059 BE	printed circuit with housing for vehicles with revolution counter with: digital clock and/or gear indicator 4 speed automatic gearbox	7000 U/MIN 24H	1	"GB."	18	357 907 345 A	hall sender for volume control radio cruise control system and/or shift mechanism 4 speed automatic gearbox	SHIFTLOCK	1	
8	893 919 040	bulb with black base only for: digital clock gear indicator	12V1,2W	X		19	357 907 359	contact plate		1	
9	357 919 061	light emitting diode	red	X		20	357 919 803	voltage regulator		1	
10	357 919 061 A	light emitting diode	green	X		21	357 998 089	set of screws instrument housing		1	
11	867 919 061	light emitting diode	yellow	X		22	N 013 950 2	tapping screw, fill. hd.	B3,5X19	2	
12	357 919 062	bulb with blue cap		1		23	N 011 554 3	washer	3,7X7X0,5	2	
13	251 919 068	cap		X		24	N 902 764 02	speed nut	3,1X16,5X11	2	
14	357 919 077	holder - light emitting diode		2		25		speedometer with kilometre trip recorder see illustration:	185-10		
15	357 919 077 A	holder - light emitting diode turn signal	MOTOMETER	2							
15	357 919 077 B	holder - light emitting diode turn signal	VDO	2							
16	357 919 253 D	revolution counter	7000 U/MIN	1							
(16)	357 919 253 F	revolution counter	8000 U/MIN	1							
(16)	357 919 253 G	revolution counter	5500 U/MIN I=1:2,23	1	diesel eng.						
(16)	357 919 253 G	revolution counter	5500 U/MIN I=1:2,23	1	diesel eng.						
17	357 919 253 E	revolution counter for vehicles with 4 speed automatic gearbox for warning zone:	7000 U/MIN 6400 U/MIN	1	"GB."						
(16)	357 919 253 L	revolution counter for vehicles with 4 speed automatic gearbox for warning zone:	7000 U/MIN 5900/6100U/MIN	1	"GB."						

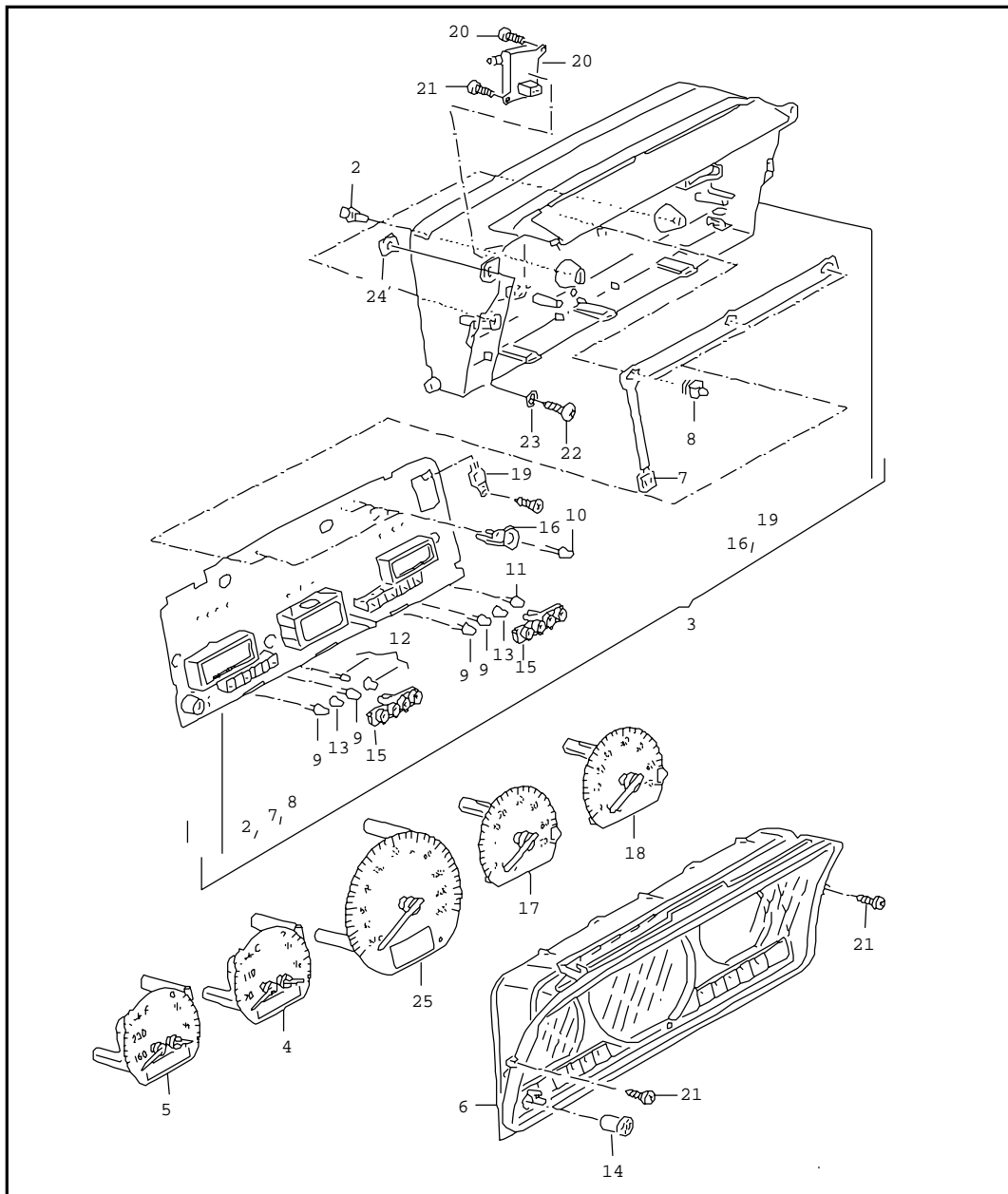

Model	Year	MG	SG	Illustration	VIN No.	Update	16:58	18.02.20100		ETKA	
PA	90	9	19	168-30		336					



Pos	Part Number	Name	Remarks	Qty	Model
		instrument housing and components for vehicles with multi function indicator F 31-M-000 001>>			
2	893 919 040	bulb with black base	12V1,2W	X	
		only for: multi function indicator speedometer and/or gear indicator 4 speed automatic gearbox			
3	357 919 042	printed circuit with housing		1	RP
(3)	357 919 042 A	printed circuit with housing		1	"GB.":RP
(3)	357 919 042 AD	printed circuit with housing		1	"GB. "/ automatic: RP
(3)	357 919 042 B	printed circuit with housing		1	"GB.":2E
(3)	357 919 042 AE	printed circuit with housing		1	"GB. "/ automatic: 2E
(3)	357 919 042 C	printed circuit with housing		1	2E
(3)	357 919 042 AG	printed circuit with housing also use:	357 919 253 M	1	
(3)	357 919 042 AH	printed circuit with housing also use:	357 919 253 M	1	"GB.":9A
(3)	357 919 042 AN	printed circuit with housing also use:	357 919 253 N	1	"GB. "/ automatic: 9A
(3)	357 919 042 F	printed circuit with housing		1	KR
(3)	357 919 042 G	printed circuit with housing		1	"GB.": KR
(3)	357 919 042 J	printed circuit with housing		1	AAA
(3)	357 919 042 K	printed circuit with housing		1	"GB.":AAA
(3)	357 919 042 AL	housing - instruments with display also use:	357 919 253 M	1	"J..":9A



Model	Year	MG	SG	Illustration	VIN No.	Update	16:58	18.02.20100		ETKA	
PA	90	9	19	168-30		336					

Pos	Part Number	Name	Remarks	Qty	Model	Pos	Part Number	Name	Remarks	Qty	Model
(3)	357 919 042 AM	printed circuit with housing for speedometer	260KMH also use: 357 919 253 N	1	"J.."/ automatic: 9A	(17)	357 919 253 J	revolution counter	7000 U/MIN	1	6 cylinder
(3)	357 919 042 AA	printed circuit with housing		1	"J..":9A	18	357 919 253 E	revolution counter for vehicles with 4 speed automatic gearbox for warning zone:	7000 U/MIN 6400 U/MIN	1	4 cylinder
(3)	357 919 042 AB	printed circuit with housing for speedometer	180KMH	1	"J.."/ automatic: 9A	(18)	357 919 253 L	revolution counter for vehicles with 4 speed automatic gearbox for warning zone:	7000 U/MIN 5900/6100U/MIN	1	"GB."/ / 4 cylinder
(3)	357 919 042 AC	printed circuit with housing		1	"J.."/ automatic: AAA	(18)	357 919 253 K	revolution counter for vehicles with 4 speed automatic gearbox	7000 U/MIN	1	6 cylinder
4	357 919 045 L	fuel and temperature gauge	0-35-70-LTR 70-110-130C	1		(18)	357 919 253 N	revolution counter for vehicles with 4 speed automatic gearbox	7500 U/MIN	1	"GB."/ /16V:9A
(4)	357 919 045 M	fuel and temperature gauge	0-8-15-GAL 70-110-130C	1	"GB."	19	357 919 803	voltage regulator		1	
6	357 919 053 H	instrument housing		1		20	191 907 346 H	sender - vacuum housing	1 BAR black	1	
7	357 919 059 AA	printed circuit foil for instrument lighting		1		21	357 998 089	set of screws instrument housing		1	
8	357 919 243 B	bulb with blue base for dashboard lighting	12V1,8W	3		22	N 013 950 2	tapping screw, fill. hd.	B3,5X19	2	
9	357 919 061	light emitting diode	red	X		23	N 011 554 3	washer	3,7X7X0,5	2	
10	357 919 061 A	light emitting diode	green	X		24	N 902 764 02	speed nut	3,1X16,5X11	2	
11	867 919 061	light emitting diode	yellow	X		25		speedometer with aperture for kilometre trip recorder see illustration:	185-3ñ0		
11	867 919 061	light emitting diode	yellow	X							
12	357 919 062	bulb with blue cap		1							
13	251 919 068	cap		X							
14	357 919 074	cap		1							
15	357 919 077	holder - light emitting diode		2							
16	357 919 077 A	holder - light emitting diode turn signal	MOTOMETER	2							
16	357 919 077 B	holder - light emitting diode turn signal	VDO	2							
17	357 919 253 D	revolution counter	7000 U/MIN	1	4 cylinder						
(17)	357 919 253 M	revolution counter	7500 U/MIN	1	16V:9A						
(17)	357 919 253 F	revolution counter	8000 U/MIN	1	4 cylinder						

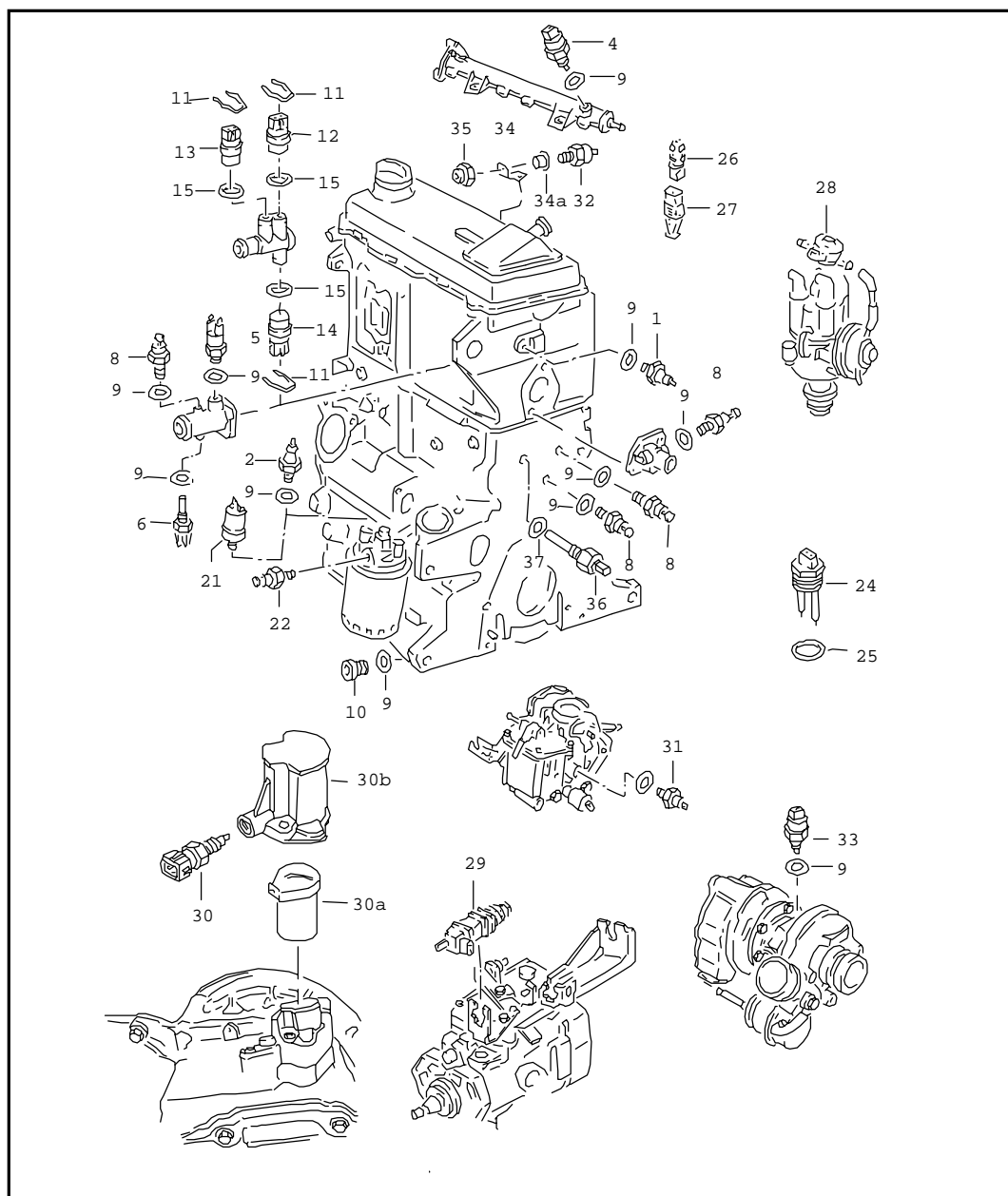

Model	Year	MG	SG	Illustration	VIN No.	Update	16:59	18.02.20100		ETKA	
PA	90	9	19	169-00		336					





Pos	Part Number	Name	Remarks	Qty	Model
		oil pressure switch thermo switch temperature sender switch for back up lamp			4 cylinder
1	028 919 081 D	oil pressure switch	0,25BAR M10X1 1 pin blue	1	
2	056 919 081 E	oil pressure switch	1,8BAR M10X1 1 pin white	1	
(2)	068 919 081	oil pressure switch	1,4BAR M10X1 1 pin black	1	
(2)	068 919 081 A	oil pressure switch	0,9BAR M10X1 1 pin grey	1	
4	357 919 081	fuel pressure switch fuel distributor	1,2BAR M10X1 2 pin brown	1	DIGIFANT: PF,PB,2E
5	035 919 369 C	thermo switch for intake manifold heating	55/65C M10X1 2 pin white	1	MONO- JETRONIC:1F
6	026 906 161	temperature sensor for vehicles with catalyst	M10X1 2 pin white	1	KE-MOTRONIC/ 16V:9A MONO- JETRONIC:1F
8	049 919 501	temperature sender for coolant temperature gauge idling stabilisation use for:	0-125C M10X1 1 pin black 027 919 501	1	KE-MOTRONIC/ 16V:9A; MONO- JETRONIC:1F; K-JETRONIC/ 16V:KR
9	N 013 806 4	sealing washer	A10X14	X	
10	N 016 024 1	plug	M10X1	X	
11	025 121 142	retaining spring		X	
12	251 919 501 D	temperature sender for coolant temperature gauge	20MM 2 pin green/black	1	DIGIFANT: PF,PB,2E; MONO- JETRONIC: RP,1F;

Model	Year	MG	SG	Illustration	VIN No.	Update	16:59	18.02.20100		ETKA	
PA	90	9	19	169-00		336					

Pos	Part Number	Name	Remarks	Qty	Model	Pos	Part Number	Name	Remarks	Qty	Model
					carburetor engine: RF,EZ; diesel eng.: 1Y,RA,SB MONOMOTRONIC AAM,RP	(13)	357 919 369	thermo switch for intake manifold heating	55/16C 20MM 2 pin green	1	carburetor engine: RF,EZ
					diesel eng.: 1Y,RA,SB MONOMOTRONIC AAM,RP	14	251 919 369 B	thermo switch for intake manifold heating	55/65C 20MM 2 pin red	1	carburetor engine: RF,EZ; MONO- JETRONIC: 1F,RP MONOMOTRONIC RP
(12)	357 919 501	temperature sender for coolant temperature gauge and glow plug relay	20MM 4 pin black/green		diesel eng.: AAZ	15	N 903 168 02	o-ring	19,6X3,65	X	
(12)	701 919 369	temperature sender for coolant temperature gauge thermo switch for intake manifold heating	20MM 4 pin black 55-65C	1	carburetor engine: EZ,RF	21	035 919 561 A	oil pressure gauge sender	0-5/1,8BAR M10X1 2 pin black	1	
(12)	251 919 501 D	temperature sender for vehicles with electroni- cally regulated air condit.	20MM 2 pin green/black	1		22	049 919 563 A	oil temperature gauge sender	0-150C M10X1 1 pin white	1	
13	191 919 369 A	thermo switch for switching off air conditioner	20MM 112-119C 2 pin greywhite	1	DIGIFANT: PF,PB,2E; diesel eng.: 1Y,RA,SB RA,SB >12/90	24	251 919 372	water level switch		X	
(13)	357 919 369 E	thermo switch for switching off air conditioner and/or electric fan 3 stages	20MM 112/119C 112/108C 4 pin brown	1	diesel eng.: RA,SB,AAZ 0191 >>	25	N 902 400 02	seal	24X4	1	
(13)	357 919 369 F	thermo switch for vehicles with electric fan 3 stages	20MM 112C 2 pin black/green	1	diesel eng.: 1Y,RA,SB,AAZ	26	357 919 379	outer temperature sensor	-25/+40C 2 pin black	1	
(13)	025 906 041 A	temperature sensor for vehicles with catalyst	20MM 2 pin blue	1	DIGIFANT: PF,PB,2E; MONO- JETRONIC: RP,1F; MONOMOTRONIC AAM,RP	26	357 919 379	outer temperature sensor	-25/+40C 2 pin black	1	
						(26)	357 919 379 A	outer temperature sensor	-40/+40C 2 pin grey	1	
						27	357 972 752	flat contact housing	2 pin	1	
						28	171 919 825 B	vacuum switch		1	
						29	323 919 827	switch for idling		X	diesel eng.: RA
						(30)	02A 945 413 B	switch for back up lamp also use: see illustration:	357 972 752 176	1 1	
						30A	02A 919 835	sleeve switch for back up lamp		1	



Model	Year	MG	SG	Illustration	VIN No.	Update	16:59	18.02.20100		ETKA	
PA	90	9	19	169-00		336					

Pos	Part Number	Name	Remarks	Qty	Model	Pos	Part Number	Name	Remarks	Qty	Model
30B		see illustration:	176								
(31)	191 919 521 A	thermo switch carburetor for vehicles with trailers for vehicles with radiator fan run-on	70C 1 pin red	M10X1	X	carburetor engine: RF,EZ					
31	281 919 521	thermo switch carburetor for vehicles with trailers for vehicles with radiator fan run-on	65C 1 pin green	M10X1	1	carburetor engine: RF,EZ					
32	191 919 521 D	thermo switch for vehicles with trailers for vehicles with radiator fan run-on	100C 1 pin yellow	M10X1	1	KE-MOTRONIC/ 16V:9A; K-JETRONIC/ 16V:KR DIGIFANT: PF,PB,2E					
33	357 919 521	temperature switch turbocharger banto bolt water pipe	115C 2 pin white	M10X1	1	diesel eng.: RA,SB					
34	027 133 336	bracket for thermostat switch cylinder head			1	K-JETRONIC/ 16V:KR					
(34)	037 133 336	bracket for thermostat switch cylinder head			1	DIGIFANT: PF,PB,2E					
(34)	051 133 336	bracket for thermostat switch cylinder head			1	KE-MOTRONIC/ 16V:9A					
34A	051 133 390	insulating bush for: bracket for thermostat switch	051 133 336		1	KE-MOTRONIC/ 16V:9A					
35	N 022 144 2	hex. nut, self-locking thermo switch	M10X1		1						
36	034 906 163	thermo time switch for vehicles with catalyst	15C 2 pin brown	M14X1,5	1	KE-MOTRONIC/ 16V:9A					
(36)	043 906 163 A	thermo time switch	35C 2 pin brown	M14X1,5	1	KE-MOTRONIC/ 16V:KR					
37	N 013 814 4	sealing washer	A14X18		1						

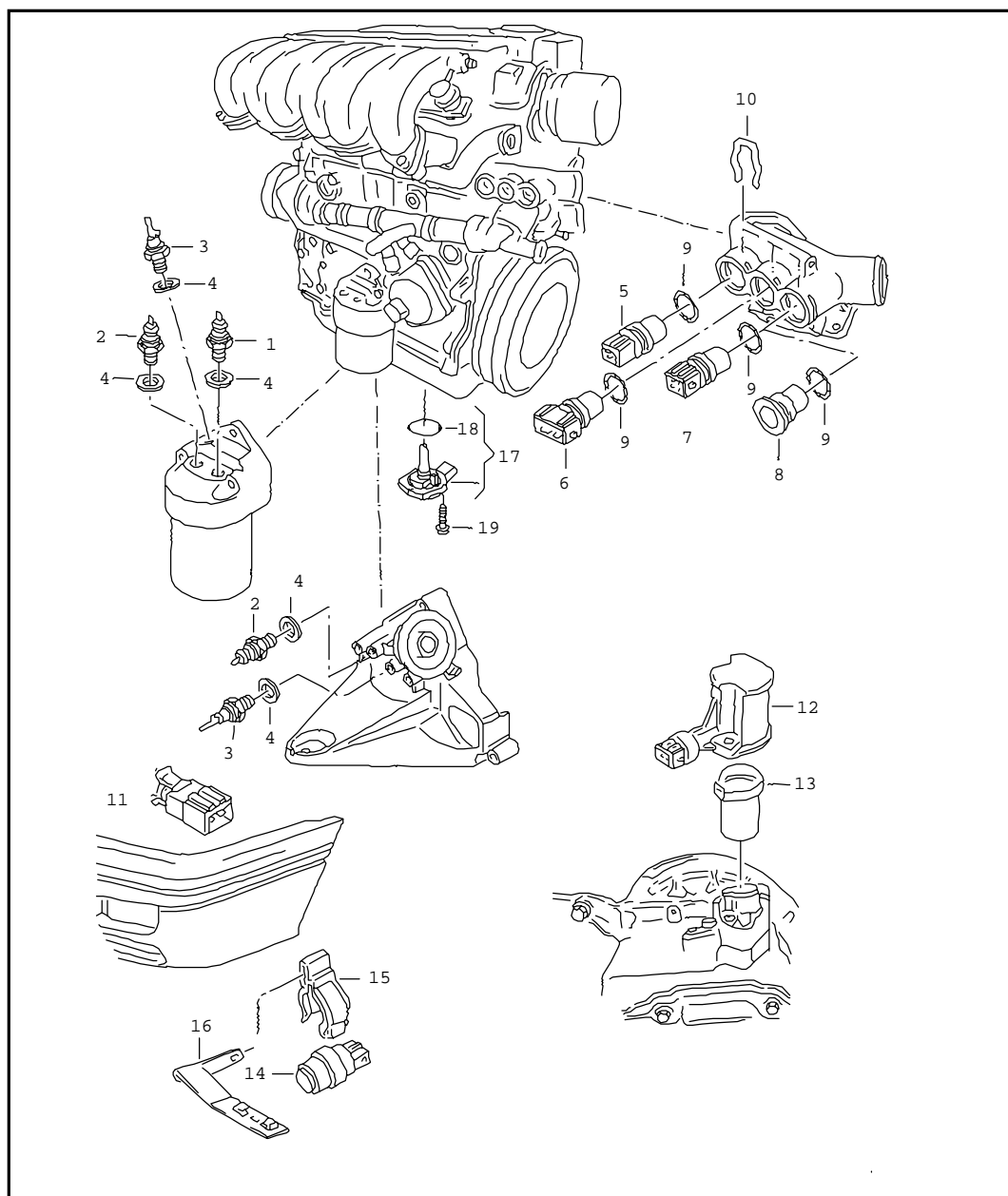
Model	Year	MG	SG	Illustration	VIN No.	Update	17:05	18.02.20100		ETKA	
PA	90	9	19	169-10		336					





Pos	Part Number	Name	Remarks	Qty	Model
		oil pressure switch thermo switch temperature sender switch for back up lamp			6 cylinder/ DIGIFANT:AAA
1	028 919 081 D	oil pressure switch	0,25BAR M10X1 1 pin blue	1	
2	068 919 081	oil pressure switch	1,4BAR M10X1 1 pin black	1	
3	1H0 919 563	oil temperature gauge sender		1	
4	N 013 806 4	sealing washer	A10X14	X	
5	701 919 369 D	temperature sender with switch for coolant temperature gauge and/or additional water pump	-- + 100/95C 4 pin blue/white 20MM	1	
6	025 906 041 A	temperature sensor NTC- engine control	20MM 2 pin blue	1	
(6)	251 919 501 D	temperature sender for coolant temperature gauge for vehicles with electroni- cally regulated air condit.	2 pin green/black 20MM	1	
7	357 919 369 E	thermo switch for switching off air conditioner and/or electric fan	112/119C 20MM 112/108C 4 pin brown 3 stages	1	
(7)	357 919 369 F	thermo switch for vehicles with electric fan 3 stages ANHAENGERBETRIEB,TROPENAUSF.O. 4 speed automatic gearbox	112C 20MM 2 pin black/green	1	
(7)	357 919 369 F	thermo switch for vehicles with electric fan 3 stages ANHAENGERBETRIEB,TROPENAUSF.O. 4 speed automatic gearbox	112C 20MM 2 pin black/green	1	
8	357 121 140	plug		X	
9	N 903 168 02	o-ring	19,6X3,65	X	

Model	Year	MG	SG	Illustration	VIN No.	Update	17:05	18.02.20100		ETKA	
PA	90	9	19	169-10		336					

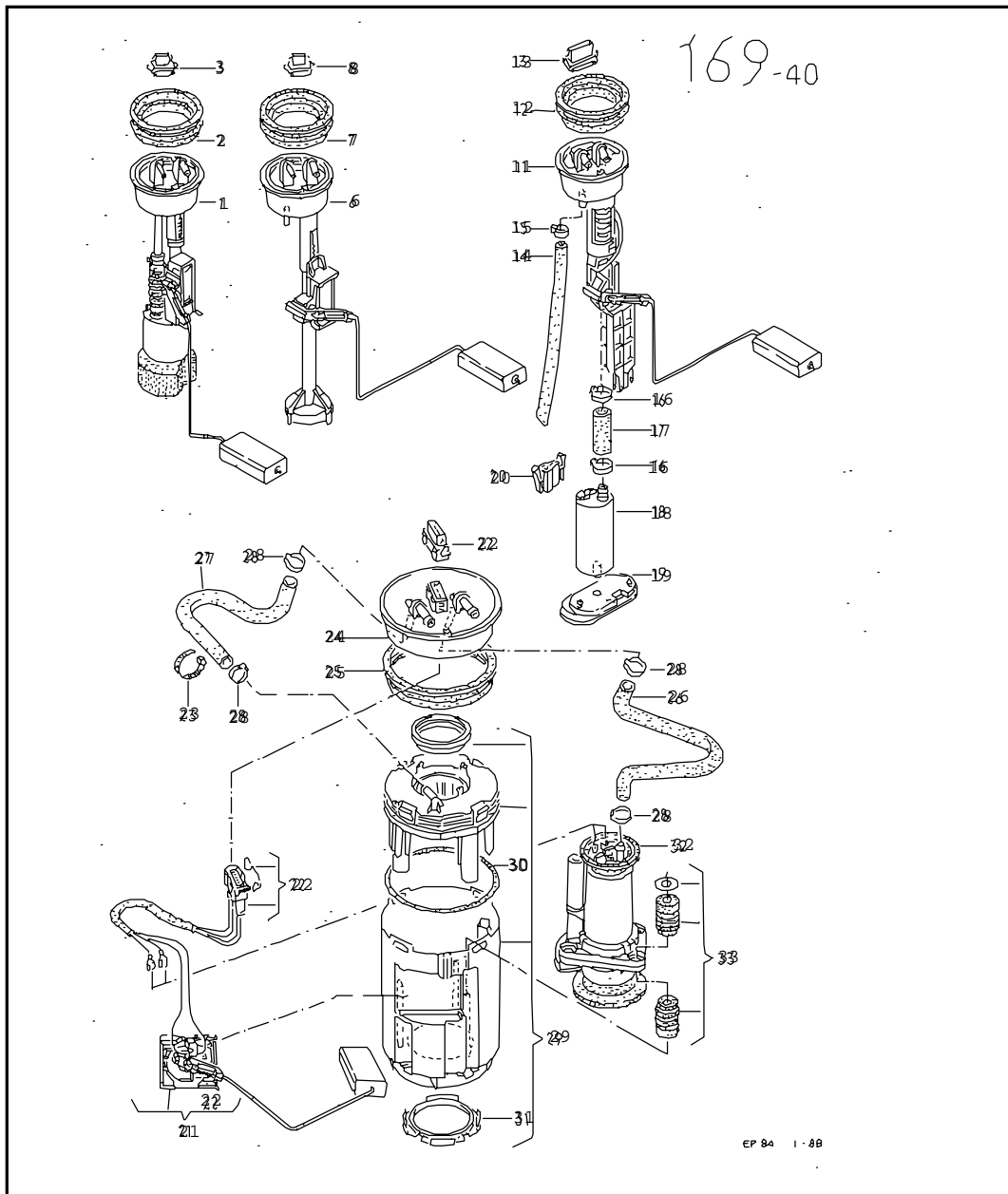

Pos	Part Number	Name	Remarks	Qty	Model	Pos	Part Number	Name	Remarks	Qty	Model
10	025 121 142	retaining spring		X							
11	357 919 379 A	outer temperature sensor	-40/+40C 2 pin grey	1							
12	02A 945 413 B	switch for back up lamp see illustration:	2 pin 176	1							
13	02A 919 835	sleeve switch for back up lamp		1							



Pos	Part Number	Name	Remarks	Qty	Model
		fuel gauge sender			diesel eng.: RA,SB,1Y,AAZ
(1)	333 919 051 L	fuel gauge sender		1	squareback
1	357 919 051 Q	fuel gauge sender		1	notchback
2	191 919 133	gasket		1	
3	357 972 752	flat contact housing	2 pin	1	
		fuel gauge sender			carburetor engine: RF,EZ
(6)	333 919 051 D	fuel gauge sender		1	squareback
6	357 919 051 F	fuel gauge sender		1	notchback
7	191 919 133	gasket		1	
8	357 972 752	flat contact housing	2 pin	1	
		fuel gauge sender			KE-MOTRONIC/ 16V:9A K-JETRONIC/ 16V:KR
(11)	333 919 052 A	fuel gauge sender		1	squareback
11	357 919 052 A	fuel gauge sender		1	notchback
12	191 919 133	gasket		1	
13	357 972 754	flat contact housing	4 pin	1	
13	357 972 754	flat contact housing	4 pin	1	
14	191 919 682	hose fuel gauge sender	return	1	
15	N 024 528 1	clip	LC8-12	1	
16	N 102 582 01	clip	AL12-22	2	
		only for:	533 919 133		

Model	Year	MG	SG	Illustration	VIN No.	Update	17:05	18.02.20100		ETKA	
PA	90	9	19	169-40		336					

Pos	Part Number	Name	Remarks	Qty	Model	Pos	Part Number	Name	Remarks	Qty	Model
(16)	N 100 980 01	clip	18,5 only for: 357 919 133	1		(21)	333 919 671	fuel gauge sender lever colour: green connector housing colour: white		1	squareback
(16)	N 100 834 01	retaining clip	14,8X6X1 only for: 357 919 133	1		21	357 919 671	fuel gauge sender lever colour: yellow connector housing colour: white		1	notchback
(17)	357 919 133	connecting piece fuel gauge sender fuel pump		1		22	357 906 231	flat contact housing	4 pin	1	
17	533 919 133	hose		X		23	N 020 902 2	cable binder	6X246	X	
18	357 906 092 C	fuel pump witout strainer	19MM VDO	1		24	357 919 679	flange	black	1	MONOJET: RP,1F; MONOMOTRONIC AAM
19	357 906 098	strainer strainer housing colour:	19MM VDO white	1		(24)	357 919 679 A	flange	white	1	DIGIFANT: PB,PF,2E,4A
20	171 971 997 D	flat contact housing	2 pin	1		25	321 919 133	sealing washer	109MM	1	
		fuel delivery unit and fuel gauge sender				(26)	N 900 801 02	hose in coils of 5m 'order unit 5' fuel gauge sender	feed return shorten to: 300MM	*	squareback
		flange colour: black	black		MONOJET:	26	357 919 681	hose fuel gauge sender	feed	1	notchback
		fuel pump	1,2BAR		RP,1F; MONOMOTRONIC AAM;	27	357 919 682	hose fuel gauge sender	return	1	notchback
		flange colour: white	white		DIGIFANT:	28	N 100 811 01	retaining clip	16,8X6X1	X	
		fuel pump	3,0BAR		PB,PF,2E,4A	29	357 919 653	housing for: fuel pump comprising: housing cover seal retaining ring retaining ring	white	1	
		use for: assembly(assy)								1 1 1 1 1	
		VARIANT	333 919 051 B		MONOJET,						
		STUFENHECK	357 919 051 B		MONOMOTRONIC 1,2BAR				upper lower		
		VARIANT	333 919 051 A		DIGIFANT:	30	357 919 659	seal housing fuel pump	upper	1	
		STUFENHECK	357 919 051 A		3,0BAR	31	357 919 666	retaining ring	lower	1	

Model	Year	MG	SG	Illustration	VIN No.	Update	17:05	18.02.20100		ETKA	
PA	90	9	19	169-40		336					

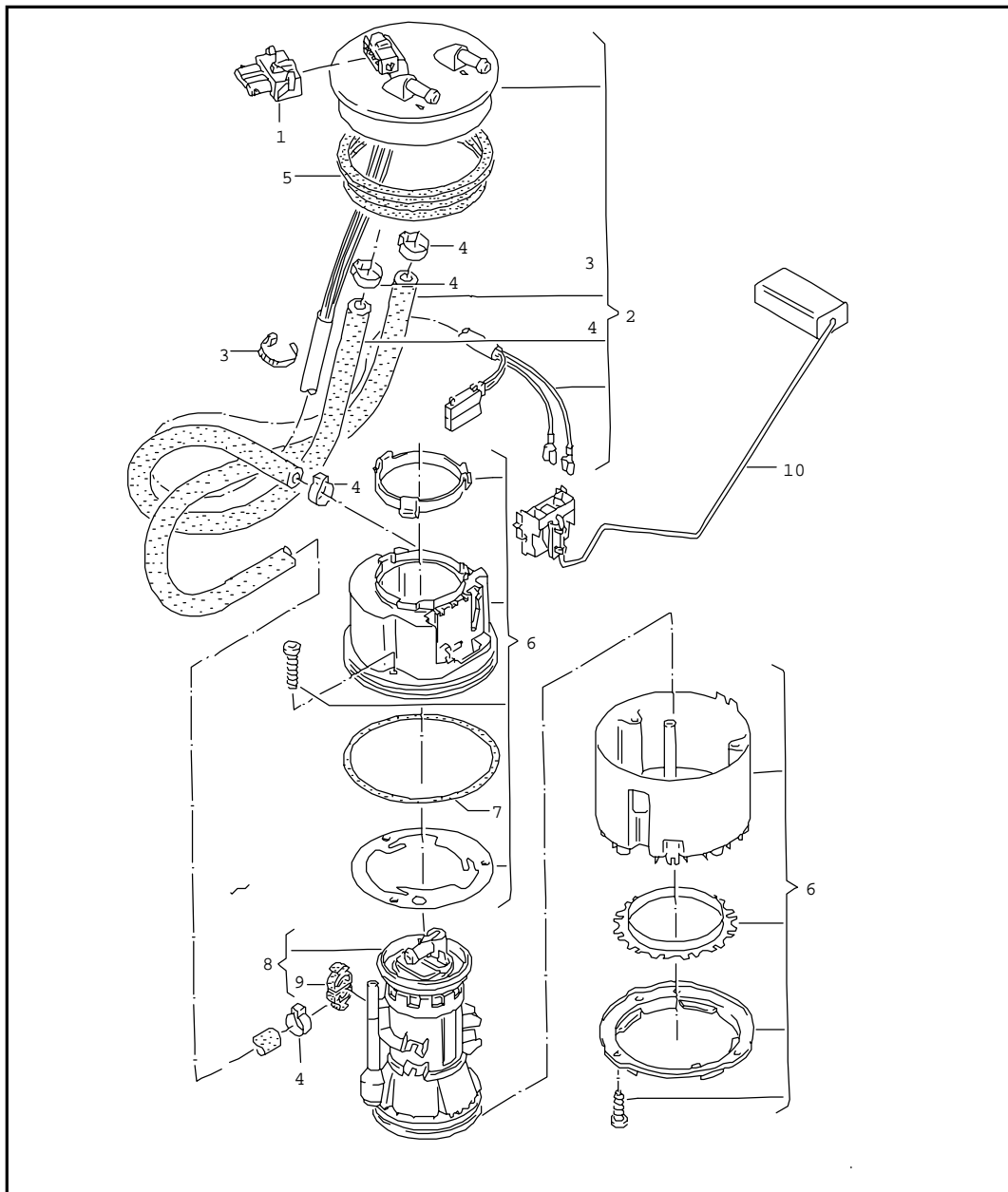

Pos	Part Number	Name	Remarks	Qty	Model	Pos	Part Number	Name	Remarks	Qty	Model
32	357 906 091	fuel pump connection plate colour: housing colour:	1,2BAR black white	1	MONOJET: RP,1F; MONOMOTRONIC AAM						
(32)	357 906 091 A	fuel pump connection plate colour: housing colour:	3,0BAR white white	1	DIGIFANT: PB,PF,2E,4A						
33	357 998 400	installation kit for fuel pump	357 906 091/A	1							



Pos	Part Number	Name	Remarks	Qty	Model
		fuel delivery unit and fuel gauge sender	PIERBURG		6 cylinder/ DIGIFANT:AAA
		with:			
		fuel pump	4,0 BAR		
		use for:			
		assembly(assy)	333 919 051 E		squareback
			357 919 051 G		sedan

		when using on a vehicle without separately supported fuel gauge sender observe enclosed leaflet			



1	357 906 231	flat contact housing		1	
2	333 919 679 B	flange		1	squareback
(2)	357 919 679 D	flange		1	sedan
3	N 020 902 2	cable binder	6X246	X	
4	N 100 811 01	retaining clip	16,8X6X1	X	
5	321 919 133	sealing washer		1	
(6)	1H0 919 051 AL	fuel delivery unit with separately supported fuel gauge sender	4BAR VDO	1	AAA
		as required use:	357 919 673 D	1	sedan
			333 919 673 B	1	squareback
			N 017 478 3	2	
-	N 017 478 3	flat sleeve 'order unit 25'	AF2,8X1	X	
7	191 919 659	seal housing fuel pump	center	1	
9	191 919 661	damping rubber		3	

Model	Year	MG	SG	Illustration	VIN No.	Update	17:06	18.02.20100		ETKA	
PA	90	9	19	169-45		336					

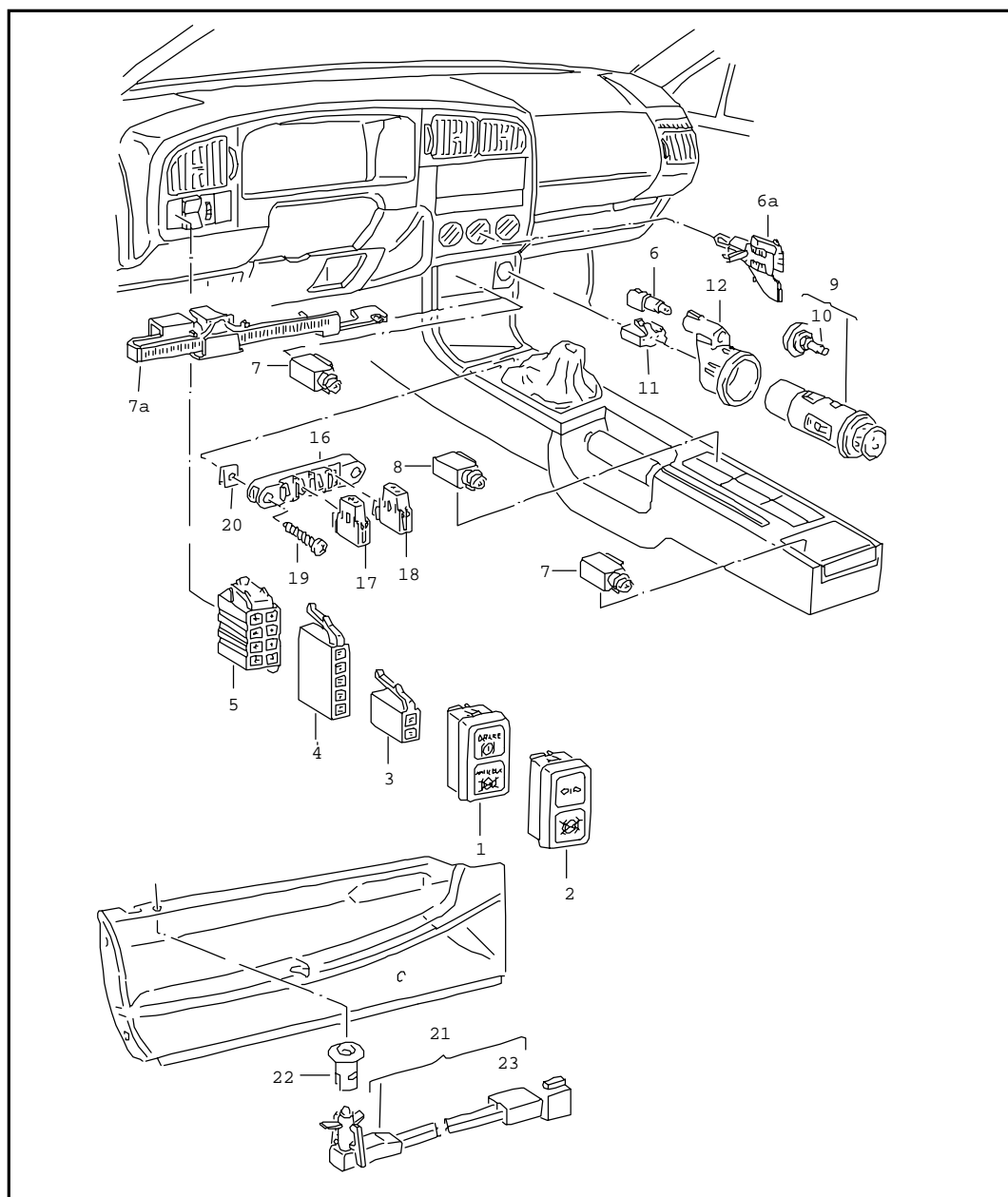
Pos	Part Number	Name	Remarks	Qty	Model	Pos	Part Number	Name	Remarks	Qty	Model
10	333 919 673 D	fuel gauge sender	PIERBURG	1	squareback						
10	333 919 673 D	fuel gauge sender	PIERBURG	1	squareback						
(10)	333 919 673 B	fuel gauge sender	VDO	1	squareback						
(10)	357 919 673 G	fuel gauge sender	PIERBURG	1	sedan						
(10)	357 919 673 D	fuel gauge sender	VDO	1	sedan						





Pos	Part Number	Name	Remarks	Qty	Model
		warning lights cigarette lighter cassette holder ashtray light			
(1)	357 919 235	warning lamp for dual circuit brakes and handbrake use for:	5 pin 357 919 235 J	1 1	
1	357 919 235 A	warning lamp for dual circuit brakes and handbrake for vehicles with anti-locking brake system -abs- use for:	8 pin 357 919 235 K	1 1	
(2)	357 919 235 B	warning lamp for vehicles with anti-locking brake system -abs-	5 pin	1	
(2)	357 919 235 C	warning lamp for vehicles with trailers	2 pin	1	
2	357 919 235 D	warning lamp for vehicles with trailers for vehicles with anti-locking brake system -abs-	8 pin	1	
(2)	357 919 235 E	warning lamp for seat belt	2 pin	1	
(2)	357 919 235 F	warning lamp for trailer operation and seat belt	8 pin	1	
(2)	357 919 235 G	warning lamp for anti-locking brake system and seat belt	8 pin	1	
(2)	357 919 235 H	warning lamp f.trailer oper., anti-locking brake system(abs) and seat belt	8 pin	1	
3	191 906 231 A	flat contact housing	2 pin	X	
4	191 906 231 D	flat contact housing	5 pin	X	
4	191 906 231 D	flat contact housing	5 pin	X	
5	357 919 968 B	flat contact housing with helper contact catch	8 pin	X	
(6)	191 919 243 D	bulb holder with bulb		1	
6A	357 919 243	bulb holder with bulb illumination for fresh air controls		1	

Model	Year	MG	SG	Illustration	VIN No.	Update	17:07	18.02.20100		ETKA	
PA	90	9	19	169-60		336					

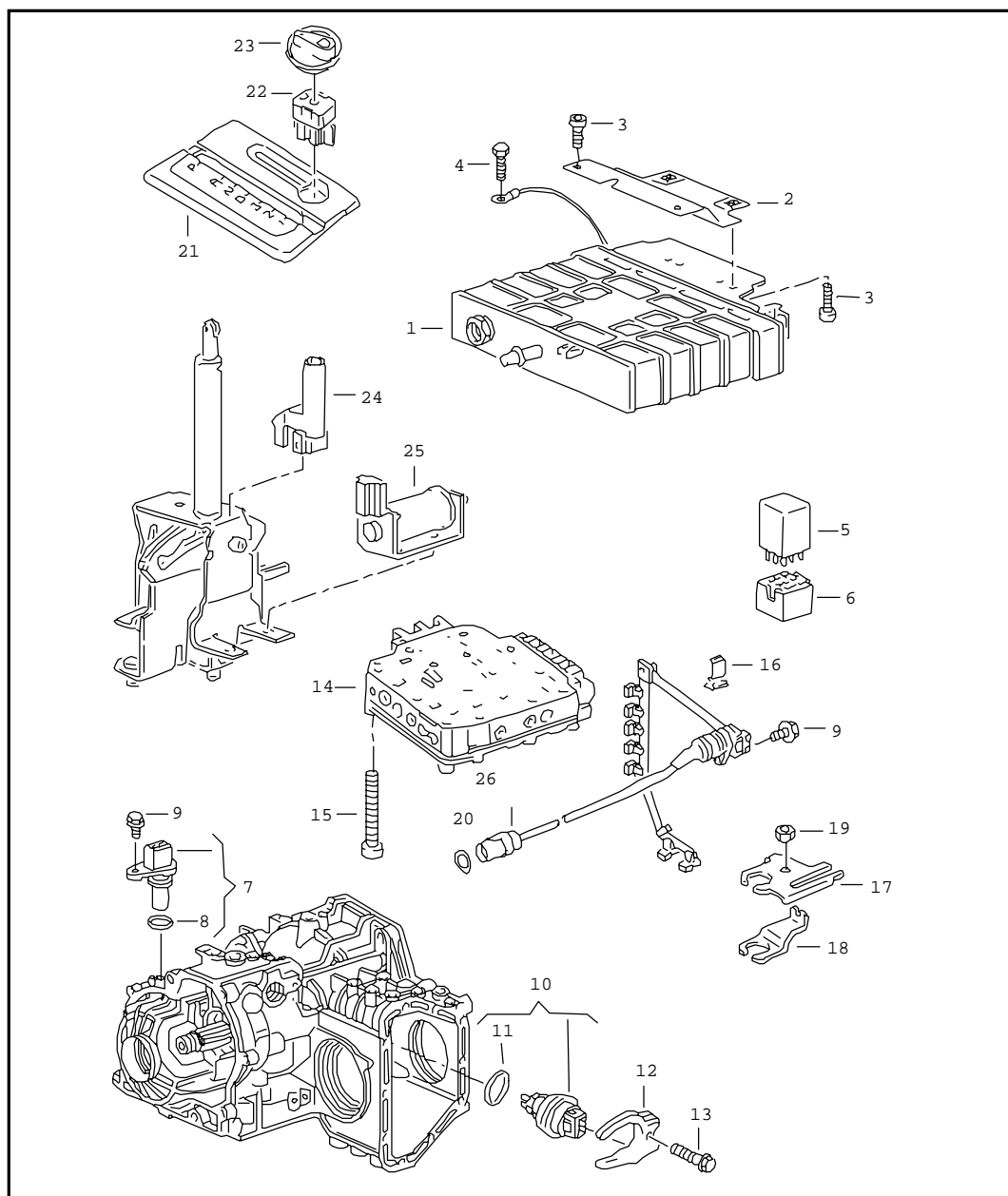

Pos	Part Number	Name	Remarks	Qty	Model	Pos	Part Number	Name	Remarks	Qty	Model
7	357 919 243 A	bulb holder with bulb ashtray light door	green rear front/rear	1	TAXI						
7	357 919 243 A	bulb holder with bulb ashtray light F >> 31-K-400 000*	green front	1							
(7A)	357 919 390 A	light fibre with bulb ashtray light as required use: F 31-L-000 001>>*	(- -) front >>31-L-400000 191 906 231 A	1 1							
-	N 017 751 2	bulb only for:	W5/1,2-12V1,2W 357 919 243 357 919 390 357 919 390 A	X							
8	357 919 243 D	bulb holder with bulb cassette holder	clear glas	1							
(9)	191 998 250 A	installation kit for cigarette lighter F >> 31-K-400 000*		1							
9	191 919 305 B	cigarette lighter F 31-L-000 001>>*		1							
10	803 919 317	glow element for cigarette lighter		1							
11	191 919 321	flat contact housing	3 pin	X							
12	191 919 343 A	retaining sleeve for cigarette lighter F >> 31-K-400 000*		1							
(12)	191 919 343 C	retaining sleeve for cigarette lighter F 31-L-000 001>>*		1							
		retaining strip for diagnosis plug									
16	443 972 559	retaining strip		1							
17	443 972 577 E	flat contact housing	2 pin	X							
18	443 972 580	flat contact housing	2 pin	X							
19	N 013 969 4	tapping screw, fill. hd.	B4,8X16	2							
20	N 902 767 01	speed nut	B4,8X14X12,6	2							



Pos	Part Number	Name	Remarks	Qty	Model
		electronic control unit valve body switch for 4 speed automatic gearbox			PF, PB, RP, 2E, 9A
(1)	095 927 731 AD	electronic control unit		1	PF, PB
(1)	095 927 731 BE	electronic control unit F >> 31-M-024 470		1	9A
(1)	096 927 731 M	electronic control unit F 31-M-024 471>>		1	9A
(1)	096 927 731 L	electronic control unit		1	2E
(1)	096 927 731 K	electronic control unit		1	RP
2	357 927 741	retaining plate		1	
3	N 014 129 13	fill. hd. screw, self locking	M5X10	4	
4	N 010 207 6	screw, hexagonal head	M5X12	1	
5	357 927 181	relay - starter F >> 31-L-400 000		1	
(5)	357 927 181 A	relay - starter F 31-M-000 001>>		1	
6	161 937 501 B	relay plate	9 pin	1	
7	095 927 321 A	sender for vehicle speed		1	
		also use:	357 972 741 A 000 979 133 A	2 2	
-	357 972 741 A	single wiring seal	5,6X7,8 red for wire cross section: 1,5	2	
8	095 321 559	seal	11X3	1	
9	N 904 407 01	screw, hexagonal head	M6X15	1	
10	095 919 823 C	multi-function switch for automatic transmission	7 pin	1	
11	095 321 529	seal	22X3	1	
12	097 321 527	bracket		1	
13	N 902 803 02	bolt, hex. hd. with shoulder	M6X20	1	



Model	Year	MG	SG	Illustration	VIN No.	Update	17:07	18.02.20100		ETKA	
PA	90	9	27	169-70		336					

Pos	Part Number	Name	Remarks	Qty	Model	Pos	Part Number	Name	Remarks	Qty	Model
14	>096 927 359	valve body		1		(24)	357 927 149	bulb holder with bulb F 31-M-000 001>>	lhd	1	
		to be used for:	QAC,QAD								
		also use:	096 321 359 C	1							
		observe									
		technical service handbook:	4.3-..			(24)	358 927 149	bulb holder with bulb F >> 31-L-245 289	rhd	1	
(14)	#096 927 359 X	valve body		1		(24)	191 927 149 C	bulb holder with bulb F 31-L-245 290>>	rhd	1	
		to be used for:	QAC,QAD								
		also use:	096 321 359 C	1							
		observe									
		technical service handbook:	4.3-..			25	191 927 353 A	electro magnet		1	
(14)	#096 927 359 V	valve body		1		26	096 927 365	printed circuit foil valve body		1	
		to be used for:	QAC,QAD					to be used for: QAD			
		also use:	096 321 359 C	1							
		observe									
		technical service handbook:	4.3-..								
-	096 321 359 C	oil sump		1							
14		see illustration:	69								
15	N 101 943 02	screw, button hd.	M6X55	14							
16	096 321 395	retaining clip		1							
17	095 321 424 E	bracket	upper	1							
18	095 321 425 A	bracket	lower	1							
19	N 011 008 18	hex. nut	M8	1							
20	095 325 381 A	seal	19X3	1							
21		trim for shift mechanism see illustration:	146								
21		trim for shift mechanism see illustration:	146								
(22)	357 959 855 H	switch F >> 31-L-200 000*		1							
	8/89 2/90 01C	satin black see illustration:	186								
22	357 927 531	switch F 31-L-200 001>>*		1							
23	357 927 533	rotary knob		1							
	2/90 7/91 01C	satin black only for:	357 929 531								
24	191 927 149	bulb holder with bulb F >> 31-L-400 000*	lhd	1							

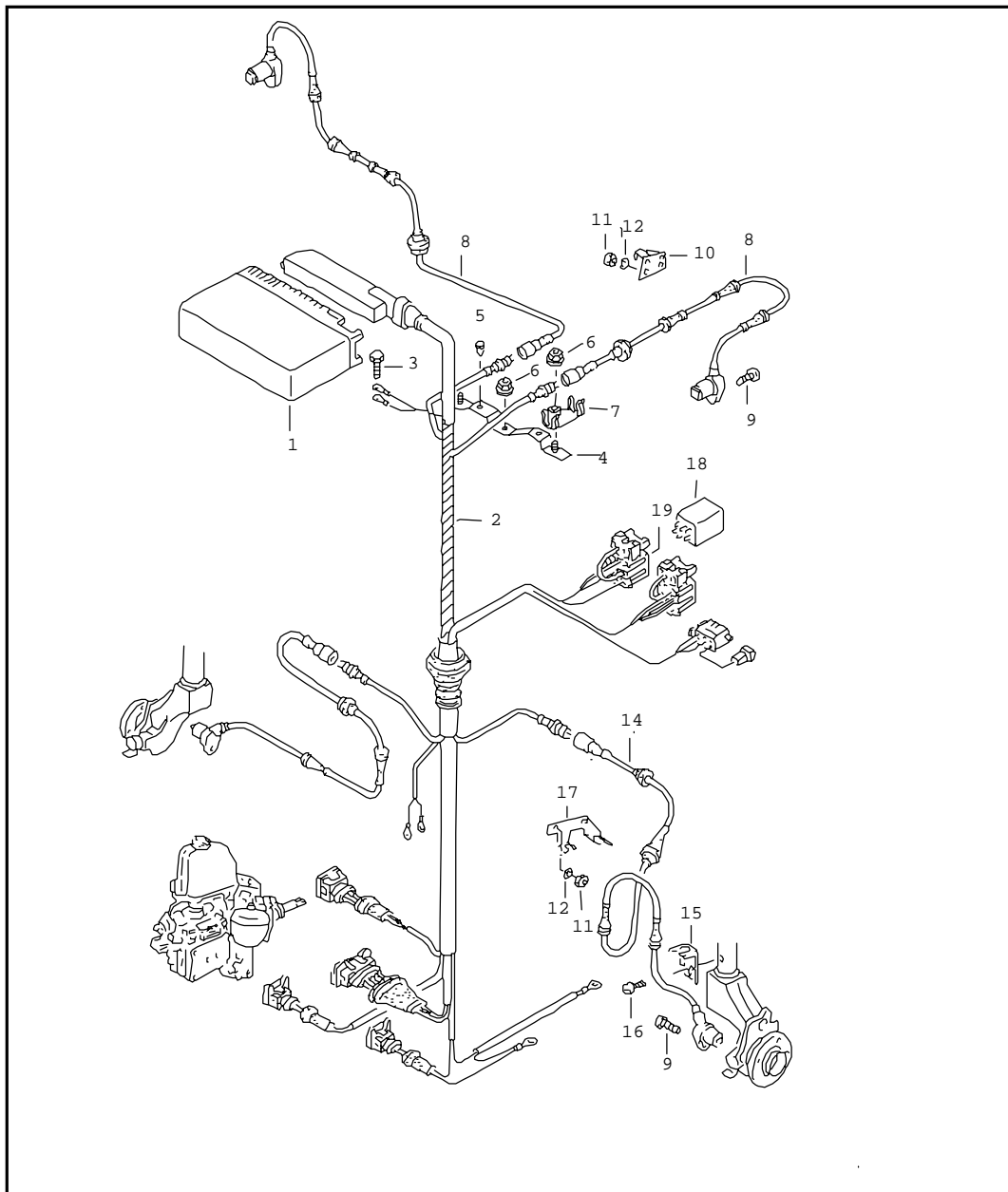

Model	Year	MG	SG	Illustration	VIN No.	Update	17:07	18.02.20100		ETKA	
PA	90	9	27	169-80		336					



Pos	Part Number	Name	Remarks	Qty	Model
		electronic control unit for anti-locking brake system-abs-speed sensor bracket for speed sensor			
1	535 907 379	electronic control unit for anti-locking brake system-abs-	lhd	1	
(1)	1H0 907 379 D	electronic control unit for anti-locking brake system-abs-	rhd	1	
(1)	535 907 379 F	electronic control unit for anti-locking brake system-abs-for vehicles with electronic differential lock -edl-		1	
2		see illustration:	239		
3	N 010 207 6	screw, hexagonal head	M5X12	1	
4	357 971 852	holder for loom speed sensor	rear	1	
5	N 020 028 1	plug	A7X1,5	2	
6	171 201 969	shouldered hex. nut	5	1	
7	893 971 898	bracket	13MM	2	
8	191 927 807 D	speed sensor	rear	2	
9	N 014 703 5	bolt, with hex. socket hd.	M6X18	4	
10	191 971 851 C	bracket for speed sensor wheel housing	left rear	1	
(10)	191 971 852 C	bracket for speed sensor wheel housing	right rear	1	
11	N 011 006 24	hex. nut	M6	4	
12	N 011 666 10	washer	B6,1X18X2	4	
-	535 971 851	guide tube speed sensor	left outer rear	1	
-	535 971 852	guide tube speed sensor	right outer rear	1	
-	191 927 811	suppression condenser speed sensor	front	2	
14	191 927 807 A	speed sensor	front	2	



Model	Year	MG	SG	Illustration	VIN No.	Update	17:07	18.02.20100		ETKA	
PA	90	9	27	169-80		336					

Pos	Part Number	Name	Remarks	Qty	Model	Pos	Part Number	Name	Remarks	Qty	Model
-	191 971 852 L	protective plate speed sensor	front	2							
15	191 971 851 F	bracket for speed sensor suspension strut mounting	left front	1							
(15)	191 971 852 P	bracket for speed sensor suspension strut mounting	right front	1							
16	N 013 970 5	tapping screw, fill. hd.	B4,8X9,5	2							
17	191 971 851 B	bracket for speed sensor wheel housing	left front	1							
(17)	191 971 852 B	bracket for speed sensor wheel housing	right front	1							
18	191 927 841	relay for anti-lock.brake syst.-abs- see illustration:	172-10	1							
(18)	357 927 843	contact close relay abs unit see illustration:	172-10	1							
19		see illustration:	239								

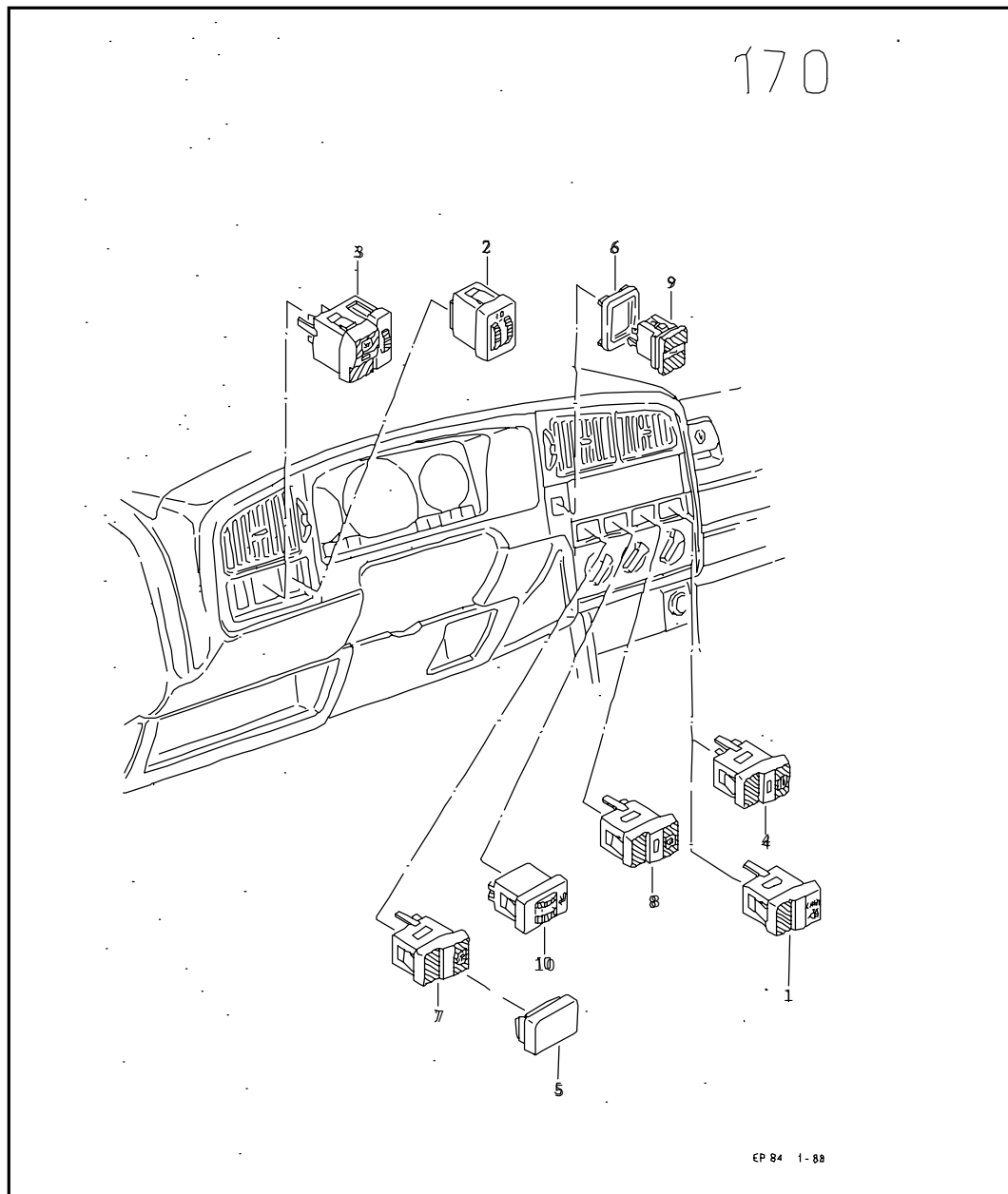

Model	Year	MG	SG	Illustration	VIN No.	Update	17:08	18.02.20100		ETKA	
PA	90	9	41	170-00		336					



Pos	Part Number	Name	Remarks	Qty	Model
		switches in dashboard			
2	357 941 333	switch for beam length regulator		1	
	4/88 7/91 01C	satin black			
3	357 941 531	switch for lighting with rheostat for panel lighting		1	
	4/88 7/91 01C	satin black			
(3)	357 941 531 A	switch for lighting with rheostat for panel lighting for vehicles with day driving headlights		1	"S..", "N..", "FIN"
(3)	357 941 531 B	switch for lighting for vehicles with dim-dip driving lights		1	"GB."
	4/88 7/91 01C	satin black			
4	535 941 535	switch for front and rear fog lights		1	
	4/88 7/91 01C	satin black			
5	357 957 087	cover	47,8X28	X	
	4/88 7/91 01C	satin black			
(5)	357 957 087 A	cover with inscription	'BLEIFREI' 'UNLEADED' 'SANS PLOMB' 47,8X28	X	
	4/88 7/91 01C	satin black			
6	357 959 550 A	switch bracket		1	TAXI
	2/89 7/89 01C	satin black			
7	703 959 561 A	switch for inner light		1	TAXI hire car
	2/89 7/91 01C	satin black			
(7)	357 959 855 K	safety switch for electric window lifters	rear	1	
	8/90 7/91 01C	satin black			
8	357 959 621	switch for heated rear window		1	TAXI; hire car



Model	Year	MG	SG	Illustration	VIN No.	Update	17:08	18.02.20100		ETKA	
PA	90	9	41	170-00		336					

Pos	Part Number	Name	Remarks	Qty	Model	Pos	Part Number	Name	Remarks	Qty	Model
	2/89 7/91 01C	satin black									
(8)	535 959 621	switch for heated rear window		1							
	4/88 7/91 01C	satin black									
9	357 959 855 C	switch for roof sign		1	TAXI						
	2/89 7/89 01C	satin black									
(9)	357 959 855 L	switch for roof sign		1	TAXI						
	8/89 7/91 01C	satin black									
10	357 963 563	switch for seat heating (driver and passenger side)		1							
	4/88 7/91 01C	satin black									
(10)	357 963 563 A	switch for seat heating (drivers side)		1							
	4/88 7/91 01C	satin black									

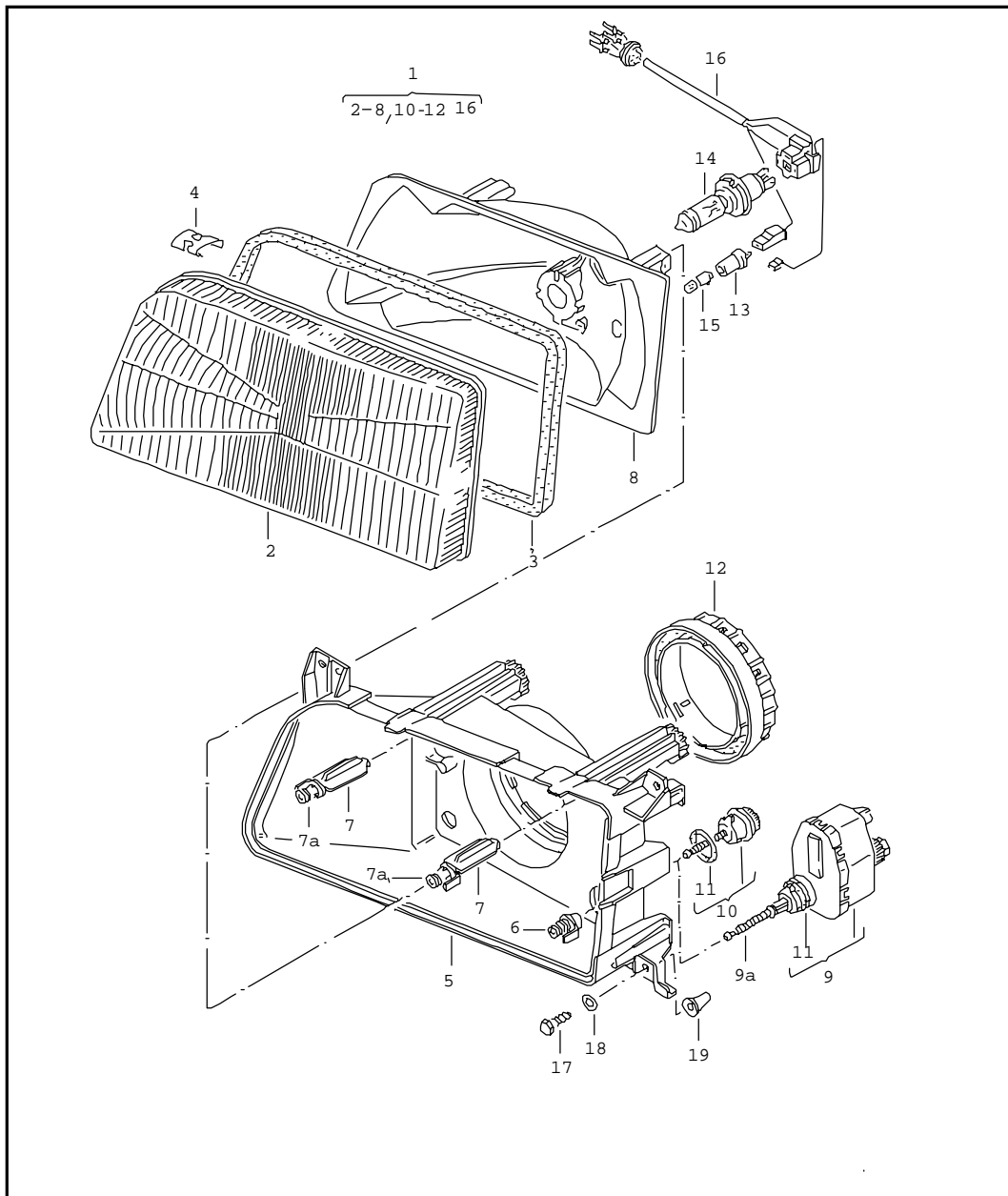
Model	Year	MG	SG	Illustration	VIN No.	Update	17:08	18.02.20100		ETKA	
PA	90	9	41	171-00		336					





Pos	Part Number	Name	Remarks	Qty	Model
		headlamp			
1	357 941 017	halogen headlamp (right-hand traffic only)	left	1	
(1)	357 941 017 B	halogen headlamp (right-hand traffic only)	left	1	"F.."
(1)	358 941 017	halogen headlamp (left-hand traffic only)	left	1	
(1)	357 941 018	halogen headlamp (right-hand traffic only)	right	1	
(1)	357 941 018 B	halogen headlamp (right-hand traffic only)	right	1	"F.."
(1)	358 941 018	halogen headlamp (left-hand traffic only)	right	1	
2	357 941 115	lens-headlamp (halogen) (right-hand traffic only)	left	1	
(2)	358 941 115	lens-headlamp (halogen) (left-hand traffic only)	left	1	
(2)	357 941 116	lens-headlamp (halogen) (right-hand traffic only)	right	1	
(2)	358 941 116	lens-headlamp (halogen) (left-hand traffic only)	right	1	
3	357 941 119	gasket		2	
4	357 941 125	retaining spring		16	
5	357 941 131	housing	left	1	
(5)	357 941 132	housing	right	1	
6	357 941 133	adjusting piece		2	
7	357 941 141	operating lever		4	
7A	535 941 142	adjusting piece		4	
7A	535 941 142	adjusting piece		4	
8	357 941 151	reflector (halogen) (right-hand traffic only)	left	1	
(8)	358 941 151	reflector (halogen) (left-hand traffic only)	left	1	
(8)	357 941 152	reflector (halogen) (right-hand traffic only)	right	1	

Model	Year	MG	SG	Illustration	VIN No.	Update	17:08	18.02.20100		ETKA	
PA	90	9	41	171-00		336					

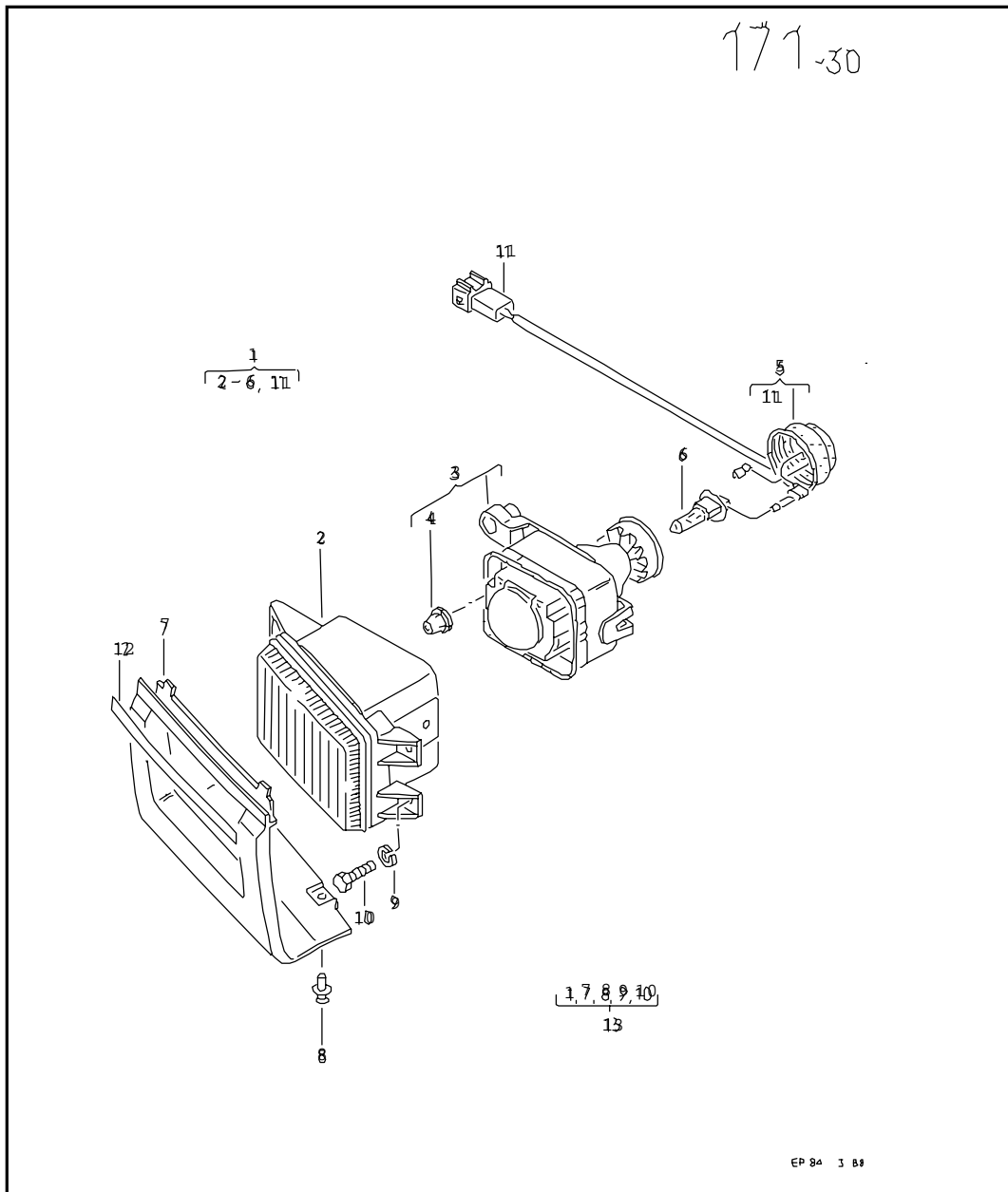

Pos	Part Number	Name	Remarks	Qty	Model	Pos	Part Number	Name	Remarks	Qty	Model
(8)	358 941 152	reflector (halogen) (left-hand traffic only)	right	1							
-	357 941 160	spring for halogen bulb		2							
9	321 941 295	motor for adjustment F >> 31-L-400 000		2							
(9)	165 941 295	motor for adjustment F 31-M-000 001>>		2							
9A	533 941 141 B	adjusting screw for vehicles with electric beam range adjustment	M5X57	2							
10	357 941 297	adapter		2							
11	443 941 323	o-ring		2							
12	357 941 607	protective cap		2							
13	411 941 669	socket for bulb		2							
14	N 017 763 2	halogen bulb	YD12V60/55W H4	2							
(14)	N 017 764 3	halogen bulb, yellow glass	YD12V60/55W H4	2							
15	N 017 717 2	bulb	HL12V4W	2							
16	357 941 951	loom		2							
17	N 013 888 2	tapping screw,hex.hd.	B5,5X19	8							
18	N 011 557 2	washer	6,4X11X1,6	8							
19	861 941 659	protective cap		4							



Pos	Part Number	Name	Remarks	Qty	Model
		halogen fog lamp			
(1)	357 941 699	halogen fog lamp	left	1	
(1)	357 941 699 A	halogen fog lamp, yellow light	left	1	
1	357 941 700	halogen fog lamp	right	1	
(1)	357 941 700 A	halogen fog lamp, yellow light	right	1	
-	441 941 715	seal	63X4	2	
(2)	357 941 723	headlamp unit	left	1	
(2)	357 941 723 A	headlamp unit, yellow light	left	1	
2	357 941 724	headlamp unit	right	1	
(2)	357 941 724 A	headlamp unit, yellow light	right	1	
(3)	357 941 727	reflector F >> 31-K-400 000	left	1	
(3)	191 941 727	reflector F 31-L-000 001>>	left	1	
(3)	191 941 728	reflector	right	1	
4	357 941 142	adjusting piece		2	
5	357 941 603	cap F >> 31-K-400 000		2	
(5)	191 941 603	cap F 31-L-000 001>>		2	
6	N 017 762 2	halogen bulb	YC12V55W H3	2	
(7)	357 941 625 D	trim	left	1	
(7)	357 941 625 C	trim primed F >> 31-M-200 000	left	1	GL
(7)	357 941 625 C	trim primed F >> 31-M-200 000	left	1	GL
(7)	357 941 625 G	trim F 31-M-200 001>>	left	1	GL
	1/91 7/91 GRU	primed			
(7)	357 941 626 D	trim	right	1	



Model PA	Year 90	MG 9	SG 41	Illustration 171-30	VIN No.	Update 336	17:08	18.02.20100		ETKA	
-------------	------------	---------	----------	------------------------	---------	---------------	-------	-------------	---	------	---

Pos	Part Number	Name	Remarks	Qty	Model	Pos	Part Number	Name	Remarks	Qty	Model
(7)	357 941 626 C	trim primed F	right	1	GL						
		>> 31-M-200 000									
(7)	357 941 626 G	trim primed F	right	1	GL						
		31-M-200 001>>									
	1/91 7/91 GRU	primed									
8	N 903 591 01	rivet		4							
9	N 012 005 3	lock ring	B5	6							
10	N 010 205 6	screw, hexagonal head	M5X10	6							
11	357 972 762	flat connector housing	2 pin								
12	357 807 401	trim strip		X	GT						
	4/88 7/88 3MD	mars red	5M								
	8/88 7/91 7ZH	grey silver metallic									
13	357 998 139	halogen fog lamp for service installation		1							

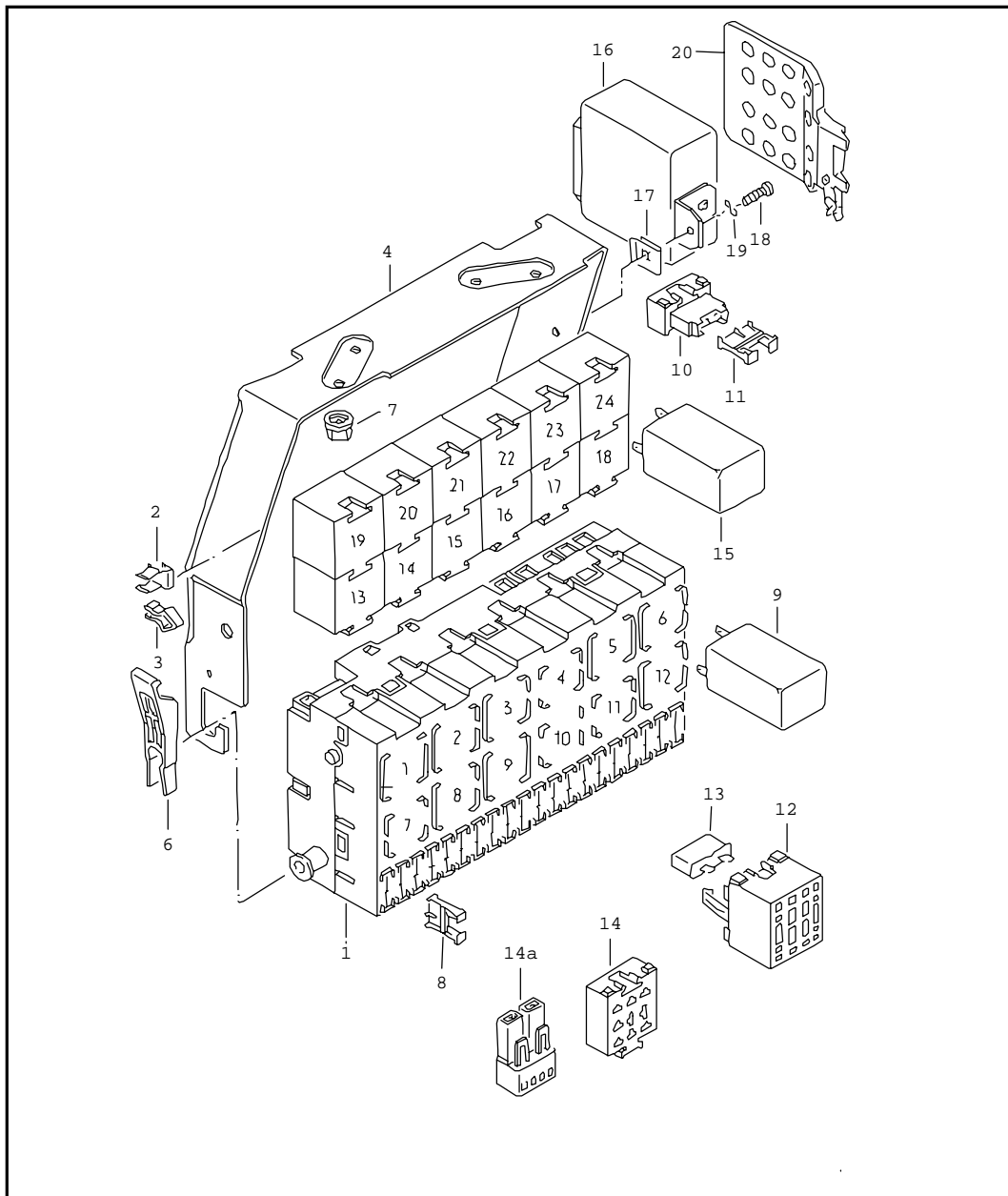

Model	Year	MG	SG	Illustration	VIN No.	Update	17:08	18.02.20100		ETKA	
PA	90	9	37	172-00		336					





Pos	Part Number	Name	Remarks	Qty	Model
		fuse box/relay plate			
		relay			
		fuse box			
		bracket - relay plate/fuse box			
1	357 937 039	fuse box/relay plate		1	
2	171 937 577	clamp		1	
3	171 937 579	tool for fuse replacement		1	
4	357 937 593	bracket - relay plate/fuse box		1	
6	191 941 856	lever		2	
7	191 941 826	press stud		3	
8	N 017 131 5	flat fuse	19/2x5 10-red	X	
(8)	N 017 131 6	flat fuse	19/2x5 15-light blue	X	
(8)	N 017 131 7	flat fuse	19/2x5 20-yellow	X	
(8)	N 017 131 8	flat fuse	19/2x5 25-natural.col	X	
(8)	N 017 131 9	flat fuse	19/2x5 30-light green	X	
-	357 998 131	1 set of flat fuses		X	
9	171 959 141 A	relay	relay location: 1	1	air condit.
(9)	357 959 141 A	relay for vehicles with electronically regulated air condit.	relay location: 1	1	
(9)	191 955 529	control unit for rear window wipe/wash system	relay location: 2	1	squareback
(9)	165 906 381	relay	relay location: 3	1	2E
(9)	357 906 381	relay	relay location: 3	1	PF,PB
(9)	357 906 381 A	relay	relay location: 3	1	1Y,AAZ,AAA
(9)	357 906 121	electronic control unit exhaust recirculation	relay location: 3	1	AAZ

Model	Year	MG	SG	Illustration	VIN No.	Update	17:08	18.02.20100		ETKA	
PA	90	9	37	172-00		336					

Pos	Part Number	Name	Remarks	Qty	Model	Pos	Part Number	Name	Remarks	Qty	Model
(9)	893 906 258	control unit for lambda probe for vehicles without catalyst relay location: 3		1	RP	(9)	141 951 253 B	relay rear fog light relay location: 10 for horn relay location: 11		1	
(9)	191 937 503	relay for relief relay x contact relay location: 4	12V40A	1		(9)	171 906 383	relay for intake manifold heating relay location: 12	carb. engine	1	EZ,RF,1F
(9)	191 919 376 A	control unit for coolant level warning lamp relay location: 5		1		(9)	191 906 383 C	contact close relay for intake manifold heating for fuel pump relay location: 12		1	RP
(9)	191 953 227 A	relay turn signal/emerg.light relay location: 6	12V	1	4X21W	(9)	191 911 261 C	control unit for glow plug relay location: 12		1	PB,PF,2E,KR,9A,1F,RP,AAA
(9)	431 953 231	relay turn signal/emerg.light for vehicles with trailers relay location: 6	12V	1	6X21W	(9)	191 911 261 C	control unit for glow plug relay location: 12		1	AAZ
(9)	701 955 200	relay for headlight washer relay location: 7		1		10	161 937 501	fuse box for flat fuses	2 pin	X	
(9)	191 955 531	control unit for intermittent wash-wipe automatic relay location: 8		1		11	N 017 131 5	flat fuse 19/2x5	10-red		
9	357 955 531	control unit for adjustable wash-wipe automatic relay location: 8		X		(11)	N 017 131 9	flat fuse 19/2x5	30-light green	X	
(9)	357 959 664 A	relay for seat belt warning system relay location: 9		1		12	191 937 501	bracket for thermo switch		1	
(9)	357 941 595	relay for fog lamp for vehicles with day driving headlights foglight switching: parking lights relay location: 10		1		13	443 937 105	thermo switch	20A	1	
(9)	141 951 253 B	relay foglight switching: parking and driving lights foglight switching: parking lights relay location: 10		1	"S.."	(13)	443 937 105 A	thermo switch for vehicles with self-levelling system	30A	1	
						14	161 937 501 B	relay plate	9 pin 2,8/6,5	X	
						(14)	867 937 501	relay plate	9 pin 2,8/6,5/9,5	X	
						15	357 906 363	retardation relay for fuel pump relay location: 13		1	PB,PF
						(15)	191 919 481	electronic control unit relay location: 13		1	1Y,RA,SB
						(15)	191 955 532 A	time control unit for electric fan relay location: 14		1	
						(15)	141 951 253 B	relay additional water pump relay location: 14		1	RA



Model	Year	MG	SG	Illustration	VIN No.	Update	17:08	18.02.20100		ETKA	
PA	90	9	37	172-00		336					

Pos	Part Number	Name	Remarks	Qty	Model	Pos	Part Number	Name	Remarks	Qty	Model
(15)	357 927 843	contact close relay abs unit relay location:	15	1							
(15)	191 927 841	relay for anti-lock.brake syst.-abs- relay location:	16	1							
(15)	443 919 533 A	control unit for heated seat relay location:	17+18	X							
		F >> 31-K-400 000									
		F 31-L-000 001>> see illustration:	172-10								
(15)	433 919 577	retardation relay relay location:	17	1	automatic: 9A						
(15)	171 959 143 A	relay electric fan motor relay location:	19	1	air condit.						
(15)	141 951 253 B	relay starter relay location:	20	1	automatic						
(15)	443 907 393 N	control unit for idling stabilization		1	KR						
(15)	443 953 233	alarm relay		1	TAXI						
		relay-emergency horn tone for high volume horn			police fire brigade ambulance						
16	191 951 273	relay-emergency horn tone for high volume horn		1							
17	N 903 682 01	speed nut	M5X21X15	1							
18	N 014 133 5	fillister hd. screw	M5X12	1							
19	N 012 222 4	spring washer	A5X10X0,5	1							
20	357 971 825	protection plate	lhd	1							

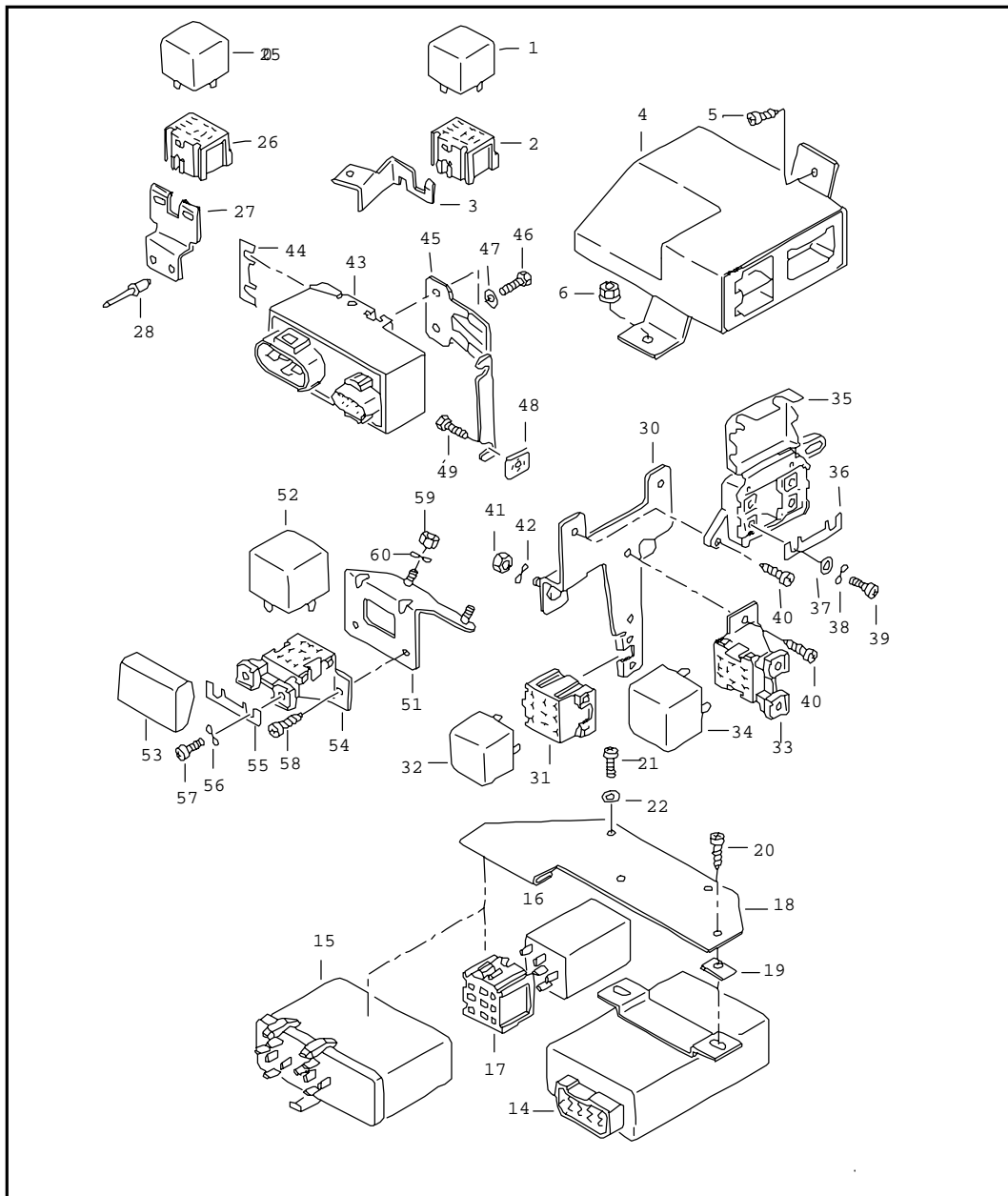

Model	Year	MG	SG	Illustration	VIN No.	Update	17:09	18.02.20100		ETKA	
PA	90	9	37	172-10		336					





Pos	Part Number	Name	Remarks	Qty	Model
		relay electric fan 2 stages 3 stages			air condit.
1	141 951 253 B	relay electric fan	2 stages	1	
(1)	357 906 121	electronic control unit exhaust recirculation		1	AAZ
(1)	701 919 505	contact close relay electric fan for vehicles with electroni- cally regulated air condit.	40A	1	
(1)	701 959 141 A	relay for electro-magnetic coupling for vehicles with electroni- cally regulated air condit.		1	
(1)	433 919 577	retardation relay		1	9A
(1)	191 906 383 A	retardation relay		1	automatic: 9A
(1)	165 906 381	relay for: electronic control unit	DIGIFANT I	1	2E
2	161 937 501 B	relay plate	9 pin	1	
3	357 972 595 A	bracket for relay		1	
4	191 959 875	windows lifters control unit		1	
(4)	357 959 875	windows lifters control unit	front	1	
(4)	357 959 875	windows lifters control unit F 31-K-060 001>>	front/rear	1	
(4)	357 959 875	windows lifters control unit F 31-K-060 001>>	front/rear	1	
(4)	357 959 875 B	electronic control unit for electric window lifters F >> 31-K-060 000	front/rear	1	
5	N 013 970 5	tapping screw, fill. hd.	B4,8X9,5	1	

Model	Year	MG	SG	Illustration	VIN No.	Update	17:09	18.02.20100		ETKA	
PA	90	9	37	172-10		336					

Pos	Part Number	Name	Remarks	Qty	Model	Pos	Part Number	Name	Remarks	Qty	Model
6	171 201 969	shouldered hex. nut		1				control unit for heated seat relay rear fog light for vehicles with trailers			
7		electronic control unit for anti-locking brake system-abs-						relay rear fog light		1	
		not a spare part				25	701 945 383	relay rear fog light		1	
8	N 014 122 8	fillister hd. screw	M4X8	2		(25)	443 919 533 A	control unit for heated seat		X	
9	N 011 522 7	washer	A4,3X9X0,5	2		26	161 937 501 B	relay plate	9 pin	1	
10	535 907 379	electronic control unit for anti-locking brake system-abs-		1	lhd	27	357 972 595 D	bracket for relay		1	
(10)	535 907 379 F	electronic control unit for anti-locking brake system-abs- for vehicles with electronic differential lock -edl-		1		28	N 016 194 3	pop-rivet	A4,8X7,6	2	
11		not a spare part						relay electric fan fuse box			
13	N 013 970 5	tapping screw, fill. hd.	B4,8X9,5	2		30	357 959 506	bracket for relay		1	1Y,AAZ,SB
		control unit for cruise control system				31	161 937 501 B	relay plate	9 pin	1	
14	443 907 305	control unit for cruise control system		1		32	701 919 505	contact close relay	40A	1	
15	443 907 393 N	control unit for idling stabilization		1	KR	33	251 937 501 B	relay plate	9 pin	1	
15	443 907 393 N	control unit for idling stabilization		1	KR	34	357 906 381 B	relay for electric fan	12V70A iii. stage	1	
16	191 906 086	relay for temperature sensor		1		35	281 937 505 A	fuse box without fuses		1	
17	161 937 501 B	relay plate	9 pin	1		36	N 017 125 3	fuse	B80	1	
18		not a spare part				37	N 011 556 2	washer	5,3X9,5X1	2	
19	N 015 436 1	speed nut	B4,8X14,8X16	2		38	N 012 005 3	lock ring	B5	2	
20	N 013 969 4	tapping screw, fill. hd.	B4,8X16	1		39	N 014 128 11	fillister hd. screw	M5X8	2	
21	N 014 129 13	fill. hd. screw, self locking	M5X10	2		40	N 013 968 1	tapping screw, fill. hd.	ST4,8X13-C	4	
(22)	N 011 523 18	washer	A5,3X10X1	2		41	N 011 006 24	hex. nut	M6	2	
						42	211 805 243	spring washer	6,4X17	2	

Model	Year	MG	SG	Illustration	VIN No.	Update	17:09	18.02.20100		ETKA	
PA	90	9	37	172-10		336					

Pos	Part Number	Name	Remarks	Qty	Model	Pos	Part Number	Name	Remarks	Qty	Model
		electronic control unit			AAA						
		electric fan									
		2 stages									
		3 stages									
43	1H0 919 506	electric fan control unit		1							
		to be used for:	1H0 919 506 A								
		also use:	N 017 125 2	X							
44	N 017 125 1	fuse	B50	1							
45	357 959 507 B	bracket for relay		1							
46	N 010 218 6	screw, hexagonal head	M6X25	2							
46	N 010 218 6	screw, hexagonal head	M6X25	2							
47	N 011 547 6	washer	A6,5X14X1,6	2							
48	N 900 317 01	speed nut	M6X25,9X18	2							
49	N 010 210 7	screw, hexagonal head	M6X10K	2							

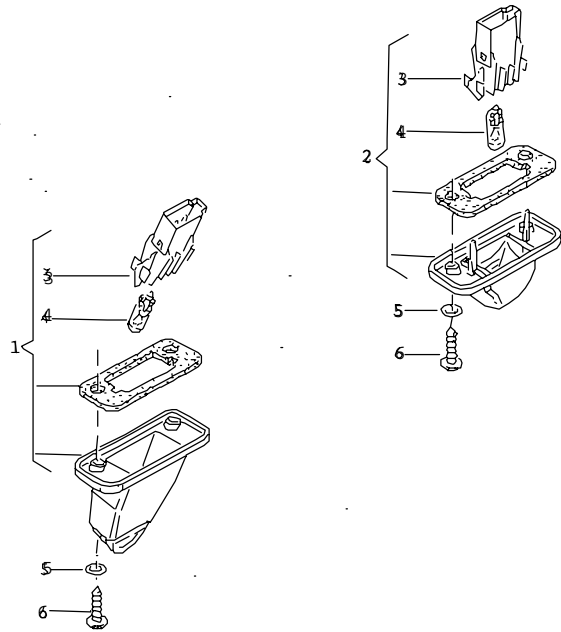

Model	Year	MG	SG	Illustration	VIN No.	Update	17:09	18.02.20100		ETKA	
PA	90	9	43	173-00		336					

173.



EP 84 1-88

Pos	Part Number	Name	Remarks	Qty	Model
		licence plate light			
1	357 943 021 B	licence plate light		2	notchback
2	357 943 021	licence plate light		2	squareback "J..": notchback
3	191 943 167	socket for bulb		2	
4	N 017 753 2	bulb	W5W12V5W	2	
5	411 945 279	washer		4	
6	N 013 961 2	tapping screw, fill. hd.	ST3,9X13	4	

Model	Year	MG	SG	Illustration	VIN No.	Update	17:09	18.02.20100		ETKA	
PA	90	9	45	174-00		336					

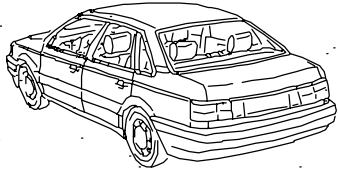

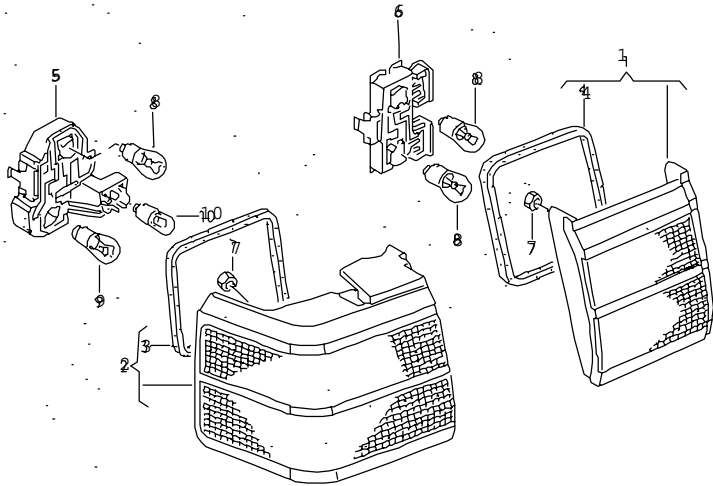

174





EP 84 1-88

Pos	Part Number	Name	Remarks	Qty	Model
		brake, turn signal and taillights			notchback
1	357 945 107	taillight with back-up light and rear fog light	left inner	1	
(1)	357 945 107 B	taillight with back-up light and rear fog light partially dimmed:	left inner black	1	
(1)	357 945 107 A	taillight with back-up light	left inner	1	
(1)	357 945 107 C	taillight with back-up light partially dimmed:	left inner black	1	
(1)	357 945 108	taillight with back-up light	right inner	1	
(1)	357 945 108 B	taillight with back-up light partially dimmed:	right inner black	1	
(1)	357 945 108 A	taillight with back-up light and rear fog light	right inner	1	
(1)	357 945 108 C	taillight with back-up light and rear fog light partially dimmed:	right inner black	1	
2	357 945 111	taillight with turn signal, brake and taillight, reflector	left outer	1	
(2)	357 945 111 B	taillight with turn signal, brake and taillight, reflector partially dimmed:	left outer black	1	
(2)	357 945 112	taillight with turn signal, brake and taillight, reflector	right outer	1	
(2)	357 945 112 B	taillight with turn signal, brake and taillight, reflector partially dimmed:	right outer black	1	
-	3A5 945 191	gasket	700MM	X	
3			shorten to:	492MM	2
4			shorten to:	485MM	2
5	357 945 257	bulb holder	left outer	1	

Model	Year	MG	SG	Illustration	VIN No.	Update	17:09	18.02.20100		ETKA	
PA	90	9	45	174-00		336					

Pos	Part Number	Name	Remarks	Qty	Model	Pos	Part Number	Name	Remarks	Qty	Model
(5)	357 945 258	bulb holder	right outer	1							
6	321 945 259	bulb holder	inner	2							
7	171 857 026 A	hex. nut	M5	10							
8	N 017 732 2	bulb	P21W12V21W	5							
9	N 017 738 2	bulb	P21/5W12V21/5W	2							
10	N 017 718 5	bulb	R5W12V5W	2							

Model	Year	MG	SG	Illustration	VIN No.	Update	17:10	18.02.20100		ETKA	
PA	90	9	45	175-00		336					

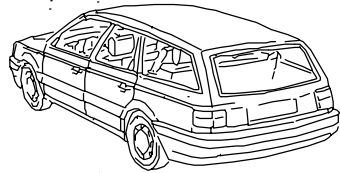

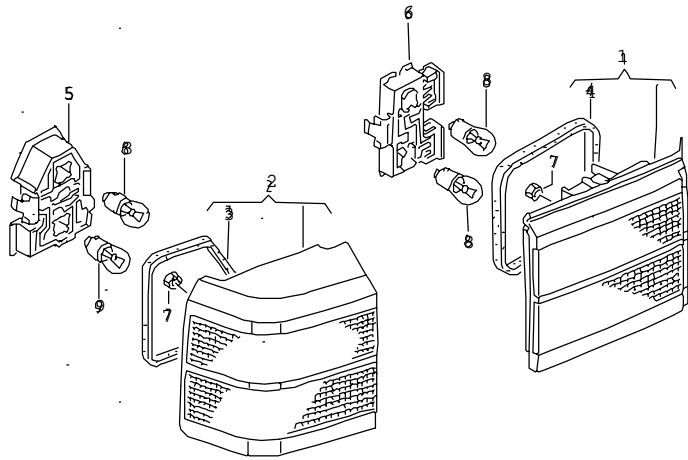

175





EP 84 2-88

Pos	Part Number	Name	Remarks	Qty	Model
		brake, turn signal and taillights			squareback
1	333 945 107	taillight with back-up light and rear fog light	left inner	1	
(1)	333 945 107 B	taillight with back-up light and rear fog light partially dimmed:	left inner black	1	
(1)	333 945 107 A	taillight with back-up light	left inner	1	
(1)	333 945 107 C	taillight with back-up light partially dimmed:	left inner black	1	
(1)	333 945 108	taillight with back-up light	right inner	1	
(1)	333 945 108 B	taillight with back-up light partially dimmed:	right inner black	1	
(1)	333 945 108 A	taillight with back-up light and rear fog light	right inner	1	
(1)	333 945 108 C	taillight with back-up light and rear fog light partially dimmed:	right inner black	1	
2	333 945 111	taillight with turn signal, brake and taillight, reflector	left outer	1	
(2)	333 945 111 B	taillight with turn signal, brake and taillight, reflector partially dimmed:	left outer black	1	
(2)	333 945 112	taillight with turn signal, brake and taillight, reflector	right outer	1	
(2)	333 945 112 B	taillight with turn signal, brake and taillight, reflector partially dimmed:	right outer black	1	
-	3A5 945 191	gasket	700MM	X	
3			shorten to: 492MM	2	
4			shorten to: 485MM	2	
5	333 945 257	bulb holder		2	

Model	Year	MG	SG	Illustration	VIN No.	Update	17:10	18.02.20100		ETKA	
PA	90	9	45	175-00		336					

Pos	Part Number	Name	Remarks	Qty	Model	Pos	Part Number	Name	Remarks	Qty	Model
6	333 945 259	bulb holder		2							
7	171 857 026 A	hex. nut	M5	10							
8	N 017 732 2	bulb	P21W12V21W	5							
9	N 017 738 2	bulb	P21/5W12V21/5W	2							

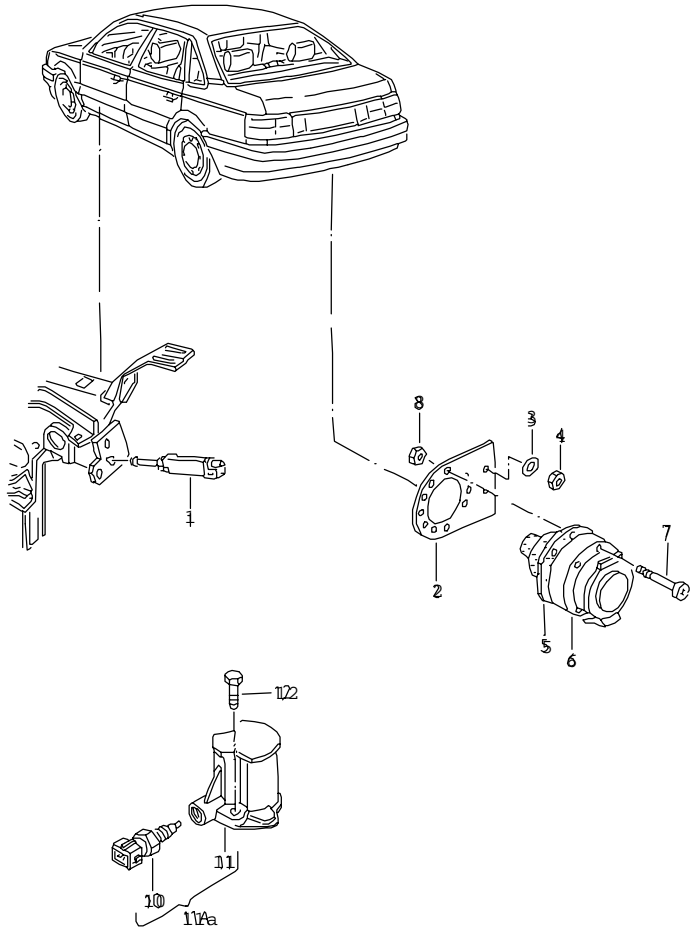

Model	Year	MG	SG	Illustration	VIN No.	Update	17:10	18.02.20100		ETKA	
PA	90	9	45	176-00		336					

176



EP 91 1-89 EP 84 1-89

Pos	Part Number	Name	Remarks	Qty	Model
		switch - brake light			
1	191 945 515	switch - brake light	lhd	1	
(1)	322 945 515	switch - brake light	rhd	1	
		socket for vehicles with trailers			
2	357 945 509	bracket		1	
(2)	357 945 509 A	bracket for vehicles with detachable towing attachment (ball type)		1	
3	N 011 507 2	washer	6,6X12,5X16	2	
4	N 022 148 1	hex. nut, self-locking	M6	2	
5	8A0 945 527	grommet		1	
6	N 101 397 01	socket	A13	1	
7	N 044 135 2	fillister hd. screw	M5X35	3	
8	N 011 182 1	hex. nut, self-locking	M5	3	
		switch for back up lamp			
10,11	--- --- --- .	discontinued / replacement:	02A 945 413 B 357 972 752	1 1	
11A	02A 945 413 B	switch for back up lamp		1	
-	357 972 752	flat contact housing	2 pin	X	
12	N 901 678 01	screw, hexagonal head	M7X1,25X19	2	

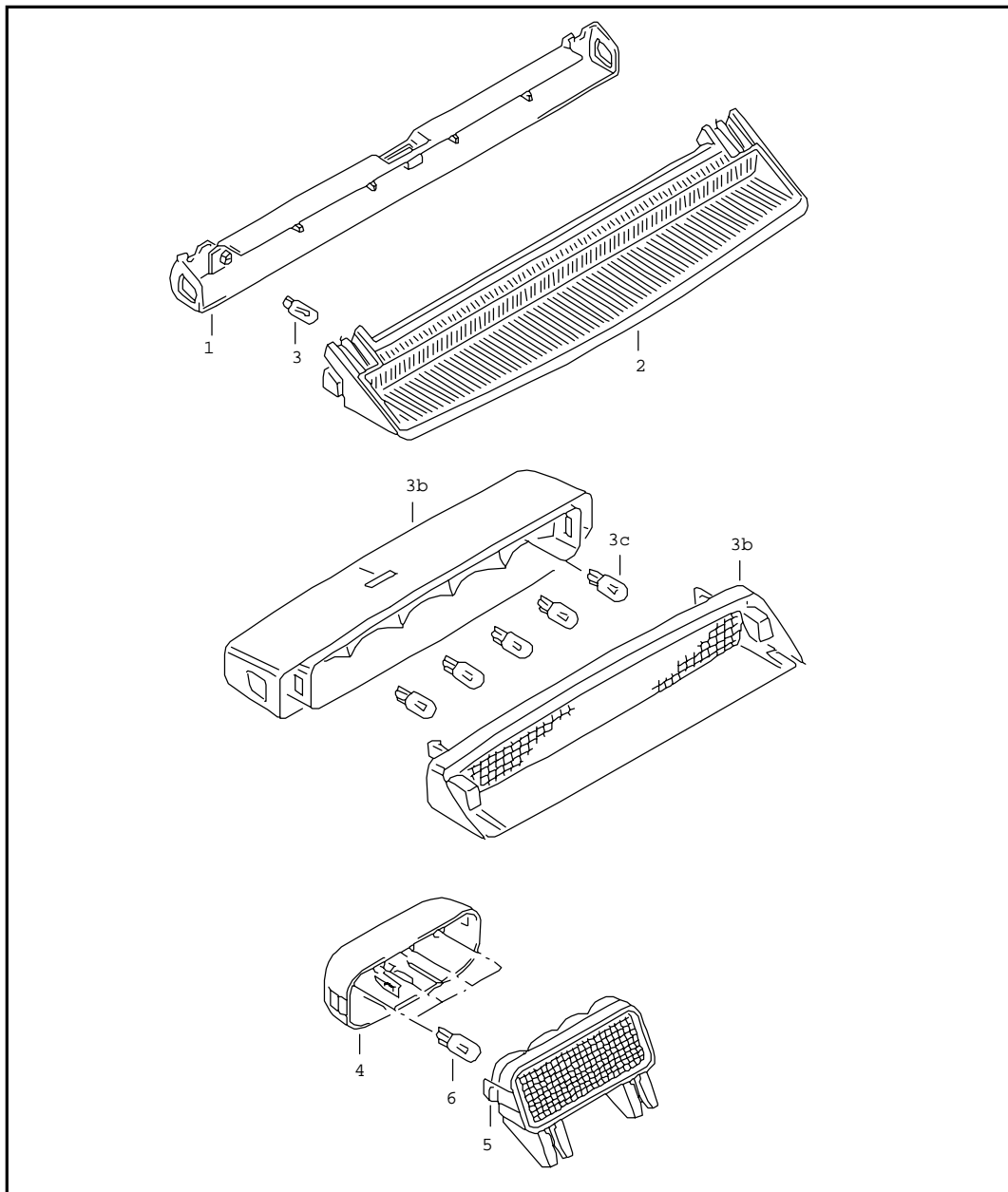

Model	Year	MG	SG	Illustration	VIN No.	Update	17:10	18.02.20100		ETKA	
PA	90	9	45	176-05		336					

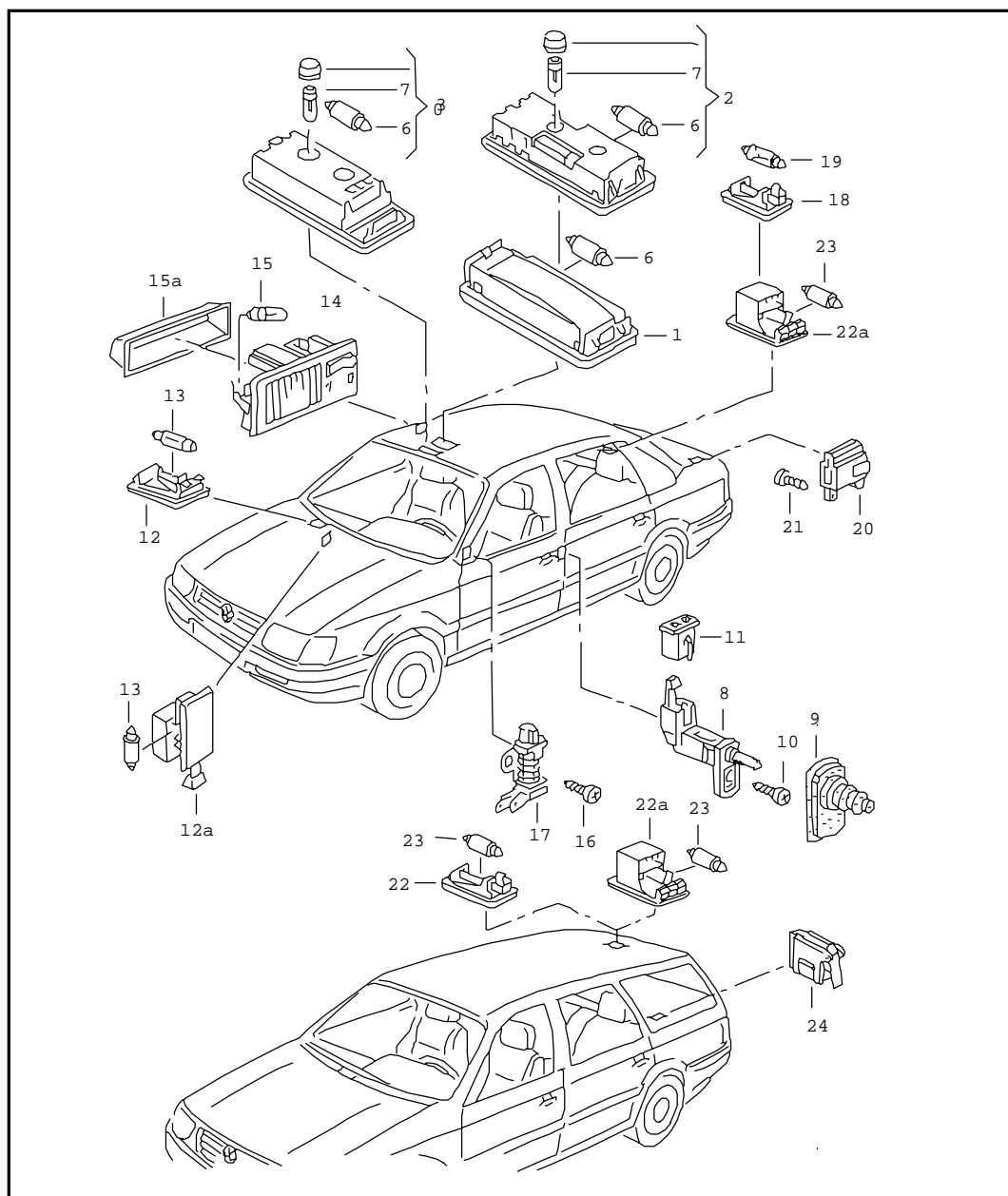

Pos	Part Number	Name	Remarks	Qty	Model
		additional brake light			"AUS": sedan
1	357 945 121	housing with bulb holder as required use:	191 972 712	1 1	
2	357 945 131	additional brake light		1	
3	N 903 605 01	bulb	12V2,1W	14	
-	191 972 712	flat connector housing for single wiring:	2 pin 000 979 126 000 979 126 A 000 979 217	1 X X X	1,0 1,0 2,5
		additional brake light			"AUS": VARIANT
4	333 945 121	housing with bulb holder as required use:	191 906 231 A	1 1	
5	333 945 122	additional brake light F >> 31-ME080 000* F >> 31-MB008 000*		1	
(5)	333 945 122 A	additional brake light F 31-ME080 001>>* F 31-MB008 001>>*		1	
6	N 017 753 2	bulb	W5W12V5W	4	
-	191 906 231 A	flat contact housing for single wiring:	2 pin 000 979 126 000 979 126 A 000 979 217	X X X X	1,0 1,0 2,5





Pos	Part Number	Name	Remarks	Qty	Model
		interior light			
1	357 947 111	interior light		1	
	4/88 7/91 01C	satin black			
2	357 947 111 B	interior and reading light with delayed switch-off		1	
	4/88 7/90 01C	satin black			
(2)	357 947 105 C	interior and reading light with delayed switch-off		1	
	8/90 7/91 01C	satin black			
6	N 017 723 2	bulb	K12V10W	1	
7	N 017 753 2	bulb	W5W12V5W	1	
8	3A0 947 561 A	switch for door contact		4	
			also use: 3A0 947 565	4	
(9)	3A0 947 565	gasket for door contact		4	
9	893 947 565 A	gasket for door contact		4	
10	N 900 949 01	fillister hd. screw	CM3,5X13	4	
11	357 947 231	flat contact housing	2 pin	4	
		glove box light			
12	171 947 311	light		1	
13	N 017 726 2	bulb	M12V3W	1	
		reading light			
14	3A0 947 291	reading light		2	
	7/91 7/91 4FB	black			
15	N 017 717 2	bulb	HL12V4W	2	

Model	Year	MG	SG	Illustration	VIN No.	Update	17:11	18.02.20100		ETKA	
PA	90	9	47	177-00		336					

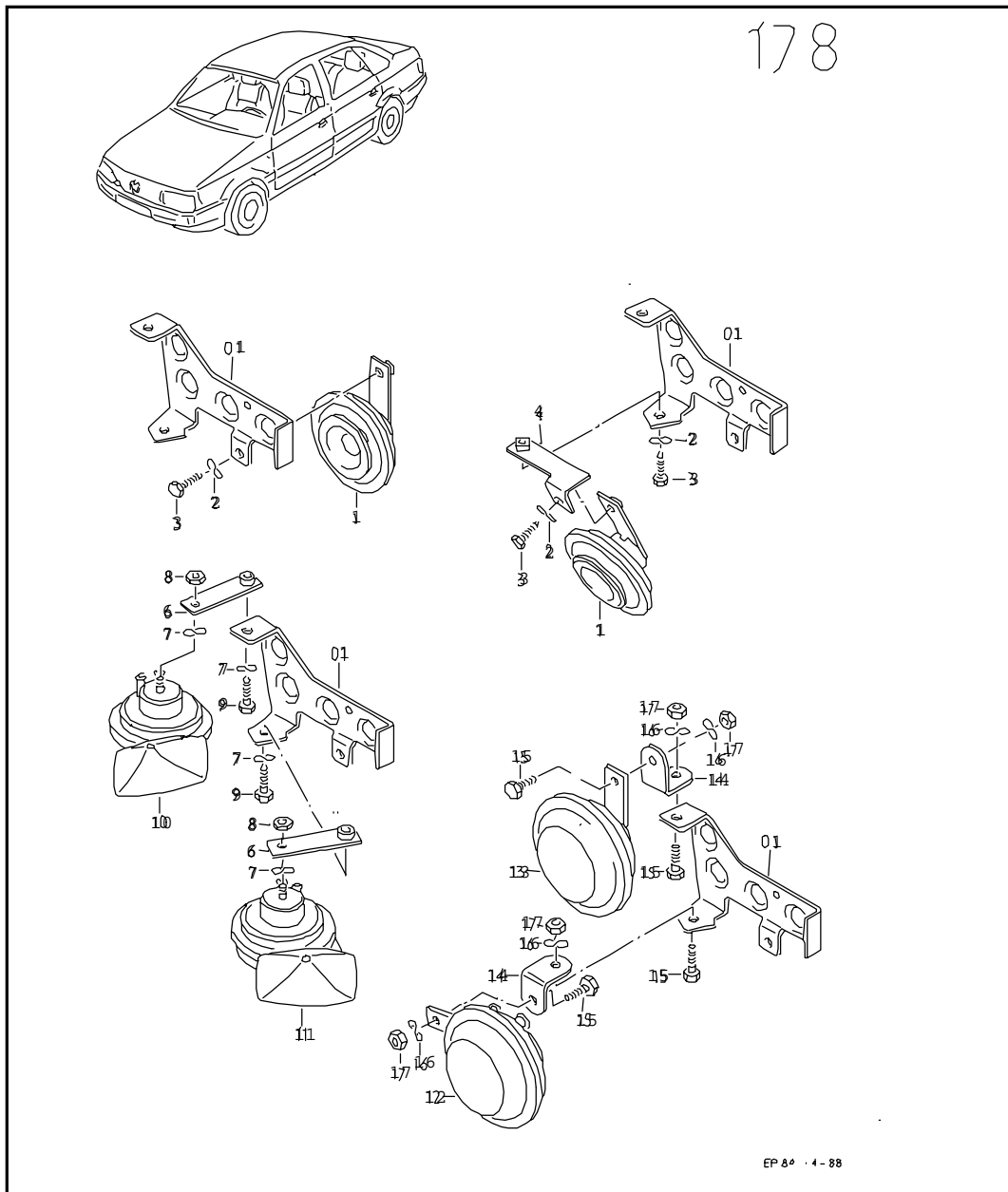

Pos	Part Number	Name	Remarks	Qty	Model	Pos	Part Number	Name	Remarks	Qty	Model
15A	357 947 297	cap for: reading light		2							
		switch for hand brake control system									
16	N 013 965 5	tapping screw, fill. hd.	B4,2X9,5	1							
17	191 947 563 B	switch		1							
		luggage boot light			notchback						
18	331 947 113	light		1							
19	N 017 725 2	bulb	L12V5W	1							
20	357 947 561	switch		1							
21	N 013 957 5	tapping screw, fill. hd.	B3,5X9,5	1							
		luggage boot light			squareback						
22	331 947 113	light		1							
23	N 017 725 2	bulb	L12V5W	1							
24	333 947 561	switch for luggage boot light		1							
24	333 947 561	switch for luggage boot light		1							



Pos	Part Number	Name	Remarks	Qty	Model
		horn			
01	357 951 185	bracket		1	
1	191 951 113 A	horn F >> 31-L-400 000		1	
(1)	191 951 113 A	horn F >> 31-L-400 000		1	
	4/88 7/90 SBV	(self-service pack)		1	
(1)	191 951 113 B	horn F 31-M-000 001>>		1	
2	N 012 038 7	lock ring	8	2	
3	N 010 239 11	screw, hexagonal head	M8X18	2	
4	357 951 183	bracket		1	
		dual horn			
6	191 951 227	bracket		2	
7	N 012 038 7	lock ring	8	4	
8	N 011 008 18	hex. nut	M8	2	
9	N 010 239 11	screw, hexagonal head	M8X18	2	
10	171 951 221	fanfare horn F >> 31-L-400 000	low tone	1	
(10)	171 951 221	fanfare horn F >> 31-L-400 000	low tone	1	
	4/88 7/90 SBV	(self-service pack)			
(10)	191 951 221	fanfare horn F 31-M-000 001>>	low tone	1	
11	171 951 223	fanfare horn F >> 31-L-400 000	high tone	1	
(11)	171 951 223	fanfare horn F >> 31-L-400 000	high tone	1	
	4/88 7/90 SBV	(self-service pack)			
(11)	191 951 223	fanfare horn F 31-M-000 001>>	high tone	1	

Model	Year	MG	SG	Illustration	VIN No.	Update	17:11	18.02.20100		ETKA	
PA	90	9	51	178-00		336					

Pos	Part Number	Name	Remarks	Qty	Model	Pos	Part Number	Name	Remarks	Qty	Model
		high volume horn									
12	191 951 215	high volume horn	low tone	1							
13	191 951 217	high volume horn	high tone	1							
14	357 951 185 A	bracket		1							
15	N 010 253 7	screw, hexagonal head	M10X22	4							
16	N 012 011 3	lock ring	A10	4							
17	N 011 010 11	hex. nut	M10	4							

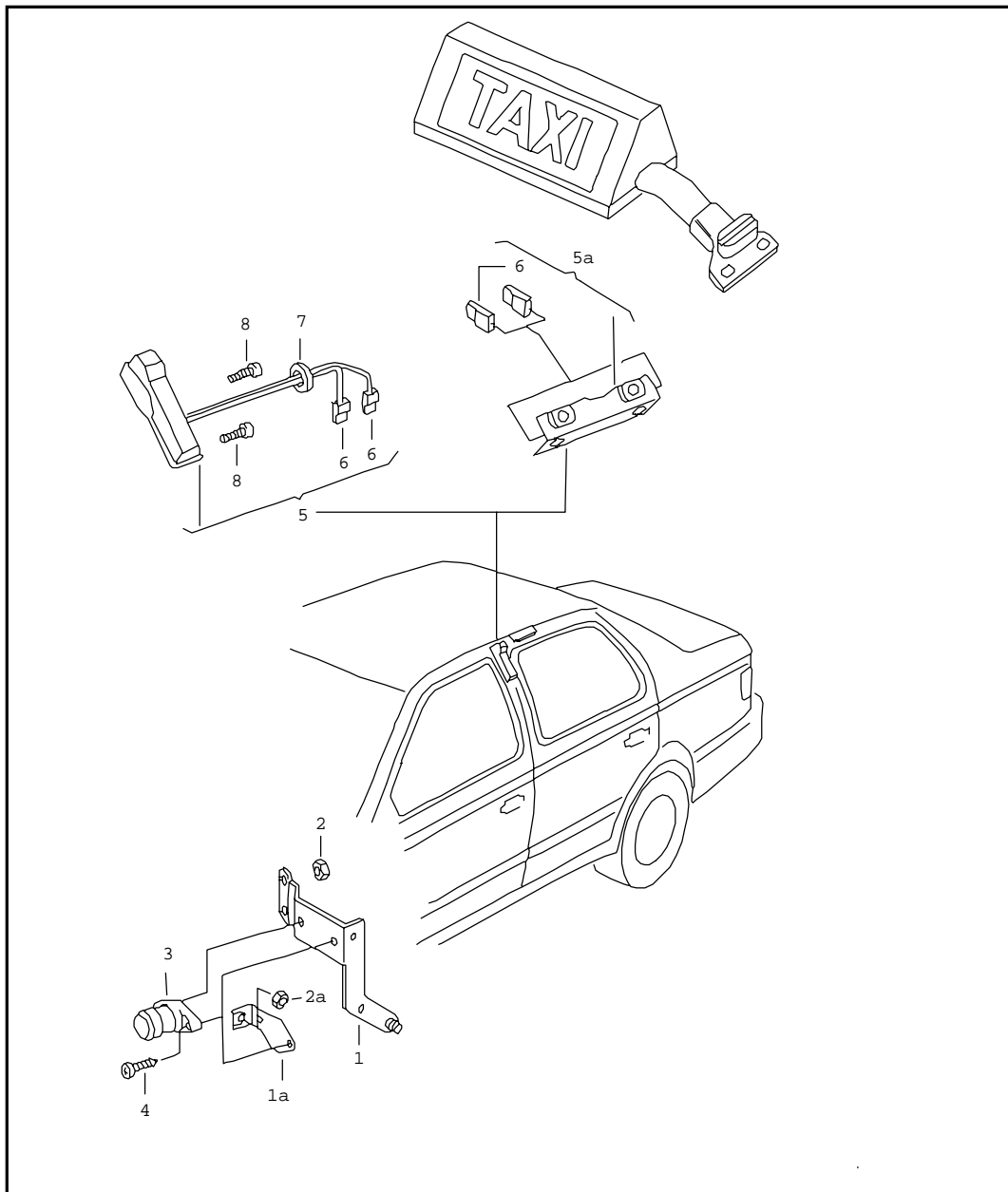

Model	Year	MG	SG	Illustration	VIN No.	Update	17:11	18.02.20100		ETKA	
PA	90	9	51	178-10		336					

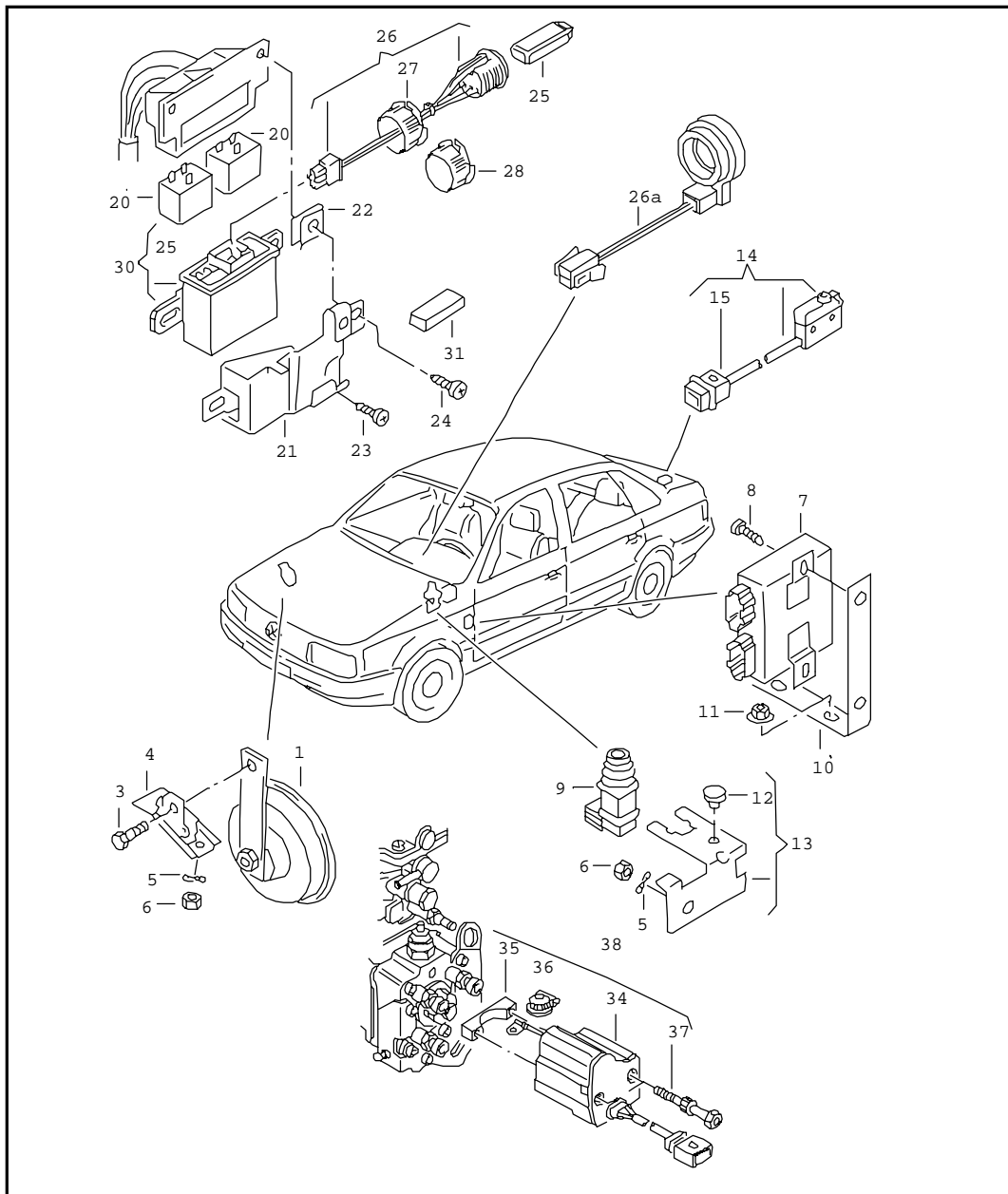

Pos	Part Number	Name	Remarks	Qty	Model
		socket for roof sign alarm switch	TAXI		
1	357 951 285	bracket		1	
2	N 902 158 02	hex. nut	M6SB	2	
3	803 951 275 B	alarm switch	'AUS'	1	
4	N 013 962 2	tapping screw, fill. hd.	B3,9X16	2	
5	357 959 923	socket F	>> 31-L-120 000*	1	
5A	357 959 923 A	bracket for taxi sign F 31-L-120 001>>*		1	
6	161 971 990 A	terminal pin housing	1 pin	2	
7	N 902 229 01	washer F	12X21X0,8 >> 31-L-120 000*	1	
8	N 014 111 2	fillister hd. screw F	AM3X12Z >> 31-L-120 000*	2	



Pos	Part Number	Name	Remarks	Qty	Model
		immobilizer for service installation			
20	141 951 253 B	relay		2	
21	3A1 953 221	bracket	lhd	1	
(21)	3A2 953 221	bracket	rhd	1	
22	N 015 439 1	speed nut	B4,8X16,5X13	2	
23	N 013 969 4	tapping screw, fill. hd.	B4,8X16	2	
24	N 902 412 03	fillister hd. screw	M4X20	1	
25	1H0 953 251	key		X	
26	1H0 953 253	coded lock with loom		1	
30	1H0 953 257	control unit for anti-theft device		1	
31	867 955 499	packing		1	
-	1H0 998 301 A	retrofit kit for immobilizer		1	

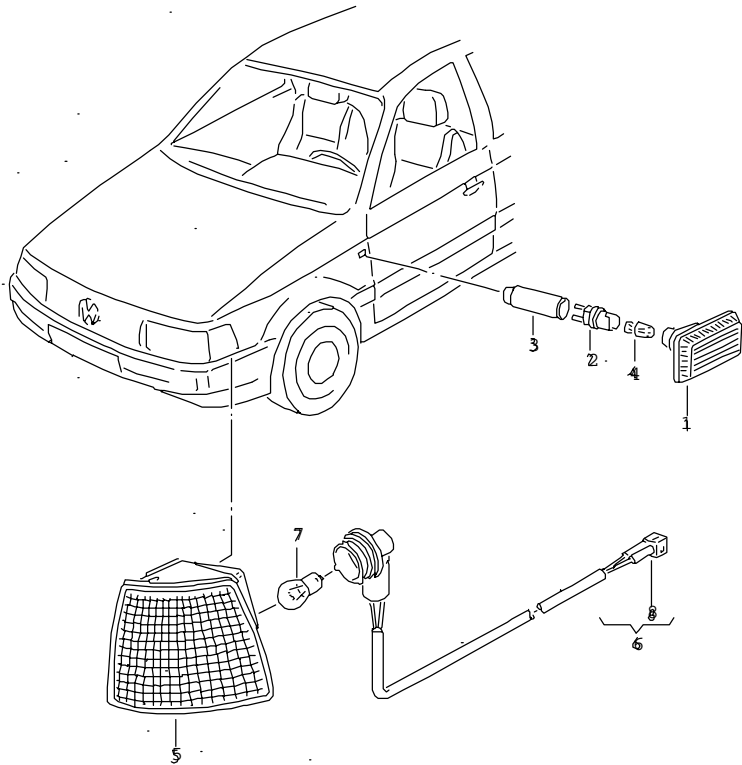

Model	Year	MG	SG	Illustration	VIN No.	Update	17:12	18.02.20100		ETKA	
PA	90	9	53	179-00		336					

179



EP 84 > 88

Pos	Part Number	Name	Remarks	Qty	Model
		turn signal	side		
1	357 949 117	turn signal		2	
(1)	161 949 117	turn signal	yellow	2	"J.."
2	161 949 111	socket for bulb		2	
3	447 953 331 A	grommet		2	
4	N 017 753 2	bulb	W5W12V5W	2	
-	357 998 101	installat. set for turn signal	side	1	
		turn signal	front		
5	357 953 049	turn signal yellow	left	1	CL
(5)	357 953 050	turn signal yellow	right	1	CL
(5)	357 953 049 A	turn signal white	left	1	GL,GT
(5)	357 953 050 A	turn signal white	right	1	GL,GT
6	535 953 123	bulb holder with harness	2 pin 730MM	2	
7	N 017 732 2	bulb	P21W12V21W	2	
8	357 972 762	flat connector housing	2 pin	2	

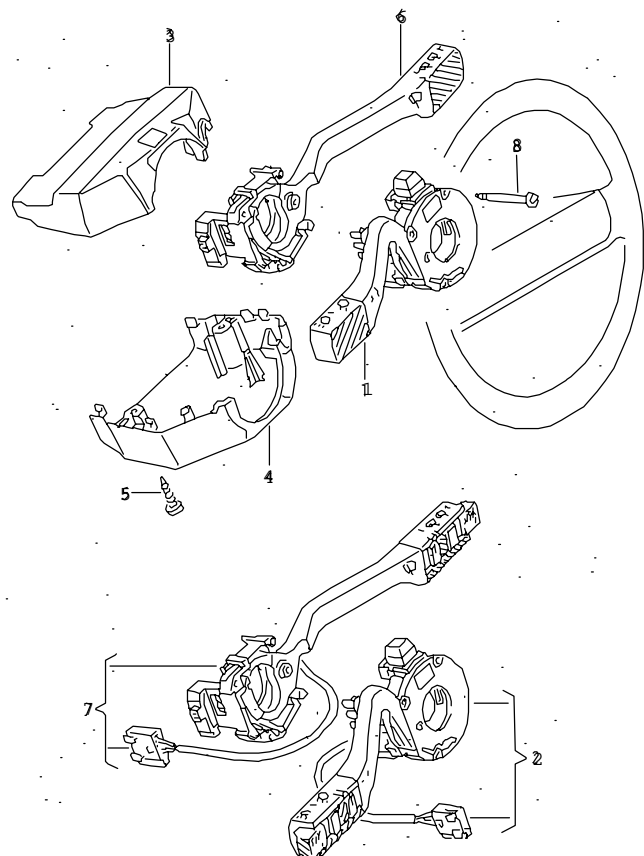

Model	Year	MG	SG	Illustration	VIN No.	Update	17:12	18.02.20100		ETKA	
PA	90	9	53	180-00		336					

180



EP 04 1-88



Pos	Part Number	Name	Remarks	Qty	Model
		switch for turn signals, high and low beams, headlight flasher, wipers and wash-wipe operation			
1	357 953 513 F	switch for turn signals,main and dip beam, headlight flasher and parking light emergency light switch		1	
	9/88 7/91 01C	satin black			
(1)	357 953 513 G	switch for turn signals,main and dip beam, headlight flasher and parking light for vehicles with two-way radio		1	
	9/89 7/91 01C	satin black			
2	535 953 513 A	switch for turn signals,main and dip beam, headlight flasher and parking light for vehicles with cruise control system		1	
	10/89 7/91 01C	satin black			
(3)	357 953 515	trim, upper part		1	
	4/88 7/91 01C	satin black			
(3)	357 953 515 D	trim, upper part for height-adjustable steering column		1	
	4/88 7/91 01C	satin black			
(4)	357 953 516	trim, lower part		1	
	4/88 7/91 01C	satin black			
(4)	357 953 516 A	trim, lower part for height-adjustable steering column		1	
	4/88 7/91 01C	satin black			
5	N 013 958 7	tapping screw, fill. hd.	B3,5X13	2	
6	357 953 519	switch for wipers and wash-wipe operation		1	
	4/88 7/91 01C	satin black			

Model	Year	MG	SG	Illustration	VIN No.	Update	17:12	18.02.20100		ETKA	
PA	90	9	53	180-00		336					

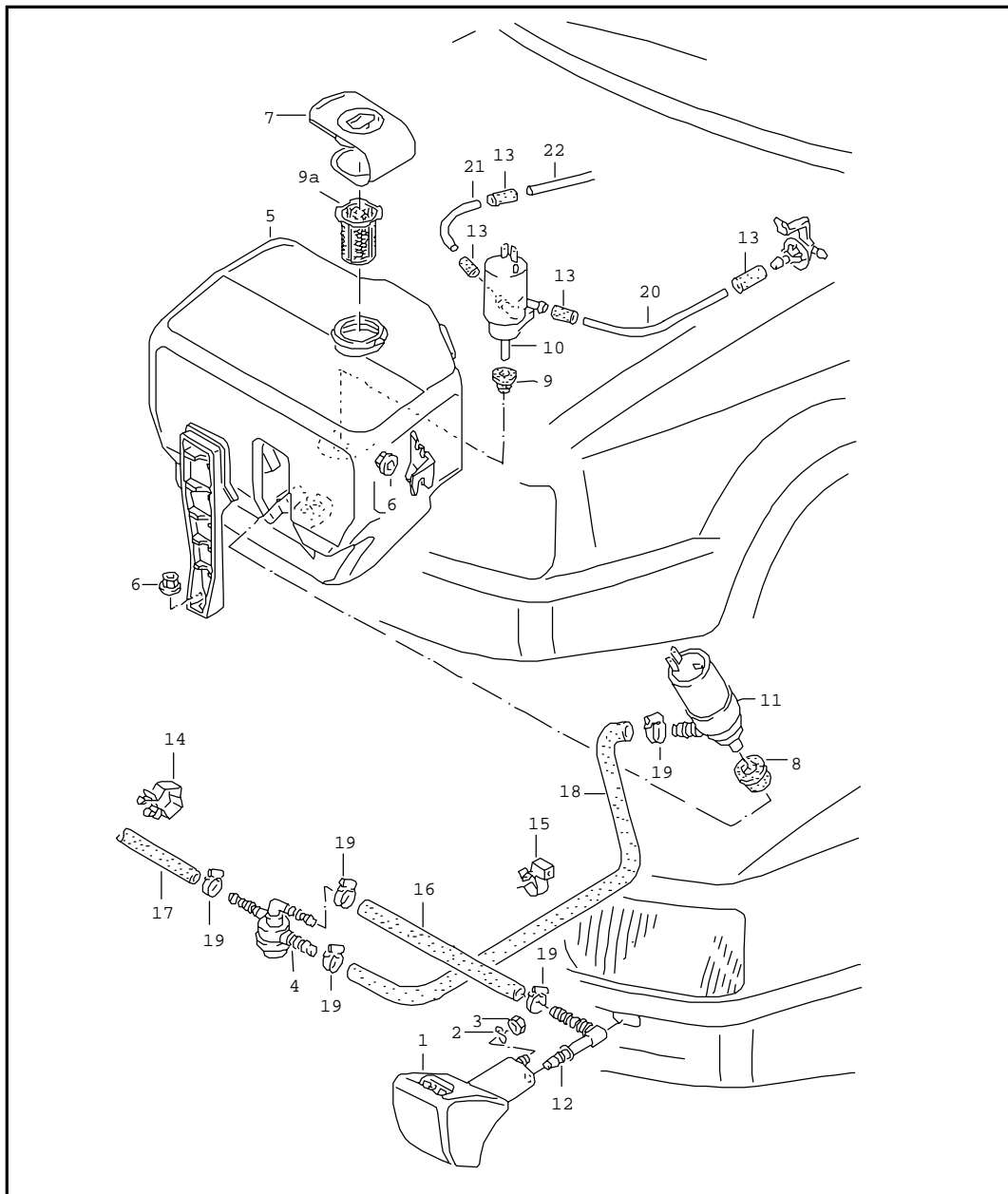

Pos	Part Number	Name	Remarks	Qty	Model	Pos	Part Number	Name	Remarks	Qty	Model
7	535 953 519 A	switch for windshield wiper, wipers and washer and multi function indicator operation with memory button		1							
	4/88 7/91 01C	satin black									
8	321 953 573	fillister hd. screw		3							



Pos	Part Number	Name	Remarks	Qty	Model
		headlight washer system			
1	357 955 101	jet carrier with jet	left	1	
(1)	357 955 102	jet carrier with jet	right	1	
2	N 012 226 5	spring washer	B6	2	
3	N 011 006 24	hex. nut	M6	2	
4	281 955 187	valve		1	
(5)	357 955 453 C	fluid container		1	
6	N 903 521 01	shouldered hex. nut	5	2	
7	357 955 455	cover		1	
8	431 955 465 A	sealing washer		1	
9	443 955 465	sealing washer	12X6,5	1	
10	333 955 651	pump windscreen washer unit		1	squareback
(10)	431 955 651	pump windscreen washer unit		1	notchback
11	191 955 681	pump headlight washer system		1	
12	191 955 976	angled pipe		2	
13	803 971 896	grommet	4X30	4	
(14)	N 902 055 01	cable binder	4,5X140	5	
15	357 955 846	clip		1	
-	N 020 348 1	hose in coils of 5m 'order unit 5'	S10X3	*	
16		shorten to:	185MM	1	
17		shorten to:	665MM	1	
17		shorten to:	665MM	1	
18		shorten to:	890MM	1	
19	N 102 582 01	clip	AL12-22	6	
-	N 020 301 1	hose in coils of 10m 'order unit 10'	4X1	*	
20		shorten to:	360MM	1	



Model	Year	MG	SG	Illustration	VIN No.	Update	17:13	18.02.20100		ETKA	
PA	90	9	55	181-00		336					

Pos	Part Number	Name	Remarks	Qty	Model	Pos	Part Number	Name	Remarks	Qty	Model
21			shorten to: 160MM	1	squareback						
-	867 955 961 A	tube	5X1X5600MM	*							
22			shorten to: 5240MM	1	VARIANT						

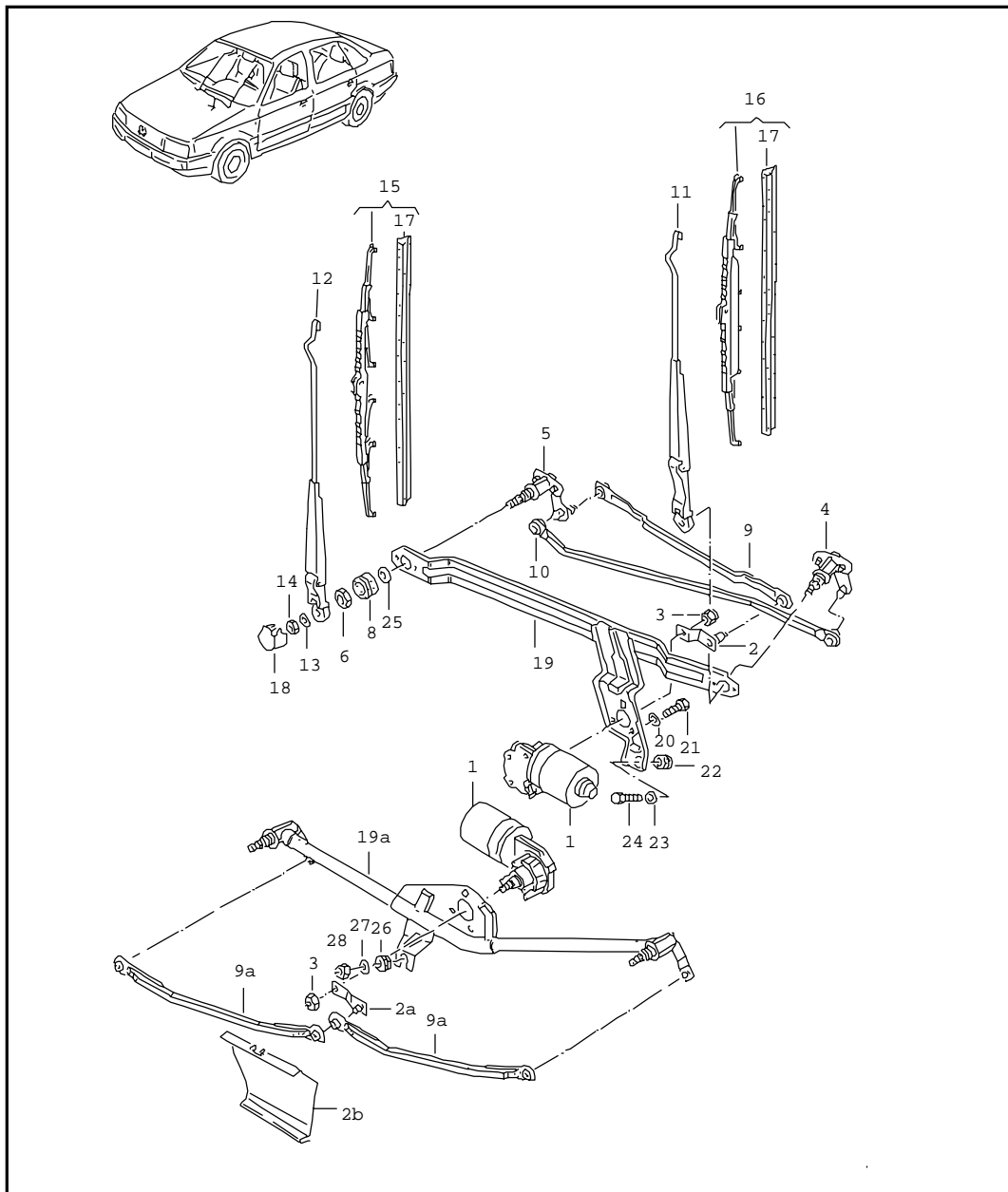
Model	Year	MG	SG	Illustration	VIN No.	Update	17:13	18.02.20100		ETKA	
PA	90	9	55	182-00		336					





Pos	Part Number	Name	Remarks	Qty	Model
		windshield wiper			
1	535 955 119 A	wiper motor without crank		1	
2	535 955 121	crank			
		F 31-J-000 001>>	rhd	1	
		F >> 31-L-260 000*	lhd	1	
2A	357 955 121	crank			
		F 31-L-260 001>>	lhd	1	
3	N 901 838 02	hex. nut, self-locking	M8	1	
4	357 955 215 A	wiper shaft with bearing	left		
		F >> 31-L-260 000*	lhd	1	
(4)	358 955 215	wiper shaft with bearing	left	rhd	1
5	357 955 216	wiper shaft with bearing	right		
		F >> 31-L-260 000*	lhd	1	
(5)	358 955 216	wiper shaft with bearing	right	rhd	1
6	823 955 243 A	hex. nut	M16X1	2	
8	N 904 655 01	grommet	20,5X24,2	2	
9	357 955 325	operating rod	485MM		
		F >> 31-L-260 000*	lhd	1	
(9)	358 955 325	operating rod	413MM		
			rhd	1	
9A	357 955 325 A	operating rod			
		F 31-L-260 001>>*	lhd	2	
10	357 955 326 A	operating rod	649MM		
		F >> 31-L-260 000*	lhd	1	
(10)	358 955 326	operating rod	655MM		
			rhd	1	
11	357 955 409	wiper arm			
		F >> 31-L-400 000	left	lhd	1
11	357 955 409	wiper arm			
		F >> 31-L-400 000	left	lhd	1
(11)	357 955 409 A	wiper arm			
		F 31-M-000 001>>	left	lhd	1
(11)	358 955 409	wiper arm			
		F >> 31-L-400 000	left	rhd	1

Model	Year	MG	SG	Illustration	VIN No.	Update	17:13	18.02.20100		ETKA	
PA	90	9	55	182-00		336					

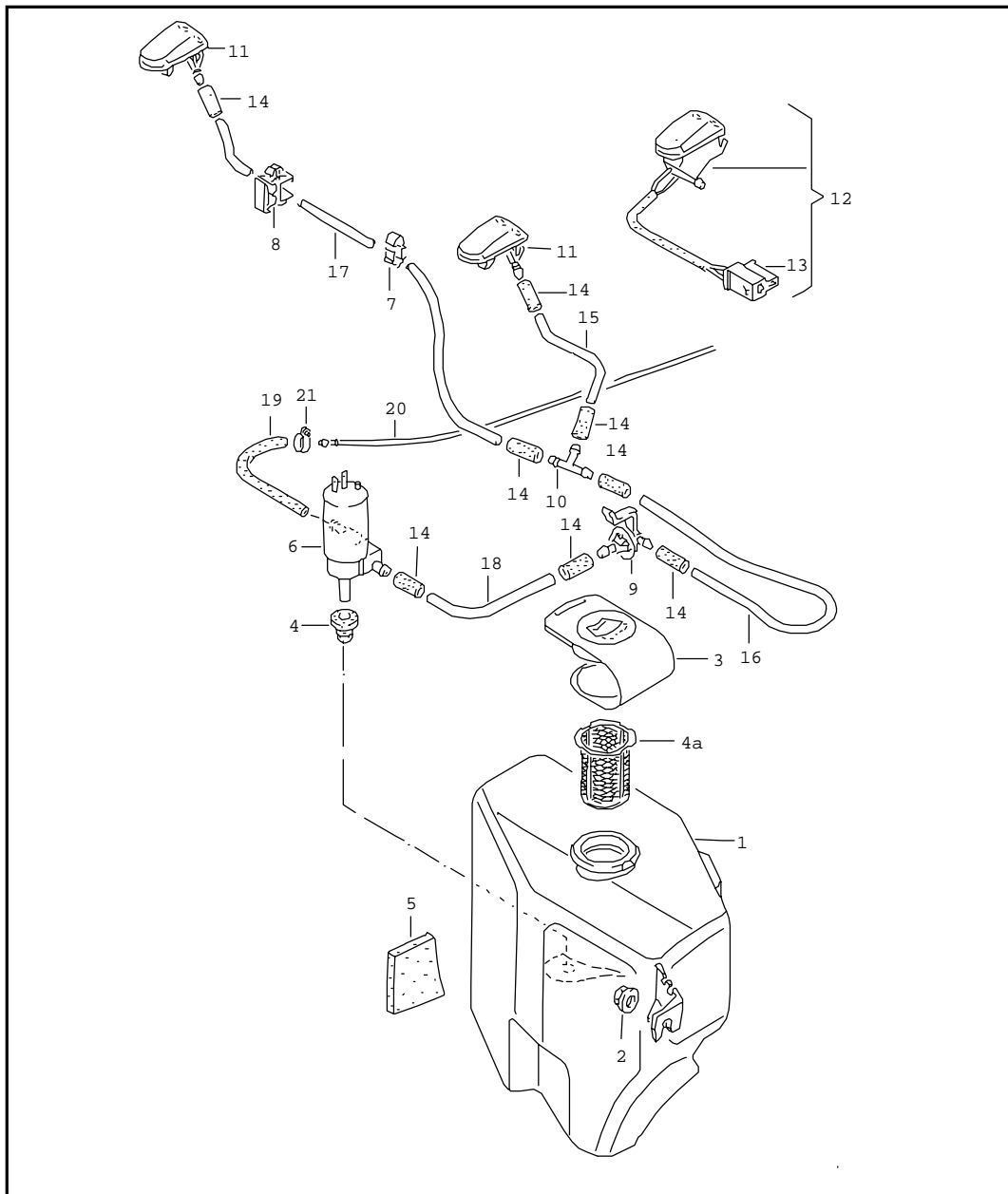
Pos	Part Number	Name	Remarks	Qty	Model	Pos	Part Number	Name	Remarks	Qty	Model
(11)	358 955 409 A	wiper arm F 31-M-000 001>>	left rhd	1		23	N 011 666 10	washer F 31-J-000 001>> F >> 31-L-260 000	B6,1X18X2 rhd lhd	1 1	
12	357 955 410	wiper arm F >> 31-L-400 000	right lhd	1		24	N 010 216 12	screw, hexagonal head F 31-J-000 001>> F >> 31-L-260 000*	M6X18 rhd lhd	1 1	
(12)	357 955 410 A	wiper arm F 31-M-000 001>>	right lhd	1		25	191 955 642	washer		2	
(12)	358 955 410	wiper arm F >> 31-L-400 000	right rhd	1		26	701 955 754	grommet F 31-L-260 001>>	14X9,5 lhd	1	
(12)	358 955 410 A	wiper arm F 31-M-000 001>>	right rhd	1		27	183 711 595	washer F 31-L-260 001>>	lhd	1	
13	N 011 558 11	washer	8,4X15X1,6	2		28	N 903 521 01	shouldered hex. nut F 31-L-260 001>>*	5 lhd	1	
14	N 011 151 3	hex. nut	M8	2		-	357 998 001 B	1 set of wiper blades F >> 31-L-400 000		1	
15	357 955 425	wiper blade (passenger side) F >> 31-L-400 000		1		-	357 998 001 D	1 set of wiper blades F 31-M-000 001>>		1	
(15)	357 955 425 C	wiper blade (passenger side) F 31-M-000 001>>		1							
16	357 955 425 A	wiper blade with air vanes (drivers side) F >> 31-L-400 000		1							
(16)	357 955 425 D	wiper blade with air vanes (drivers side) F 31-M-000 001>>		1							
17	895 955 429 A	rubber for wiper blade	550MM	2							
17	895 955 429 A	rubber for wiper blade	550MM	2							
18	357 955 435	cap		2							
(19)	358 955 605	wiper frame	rhd	1							
19A	357 955 603 A	base, windshield wiper also use: F >> 31-L-260 000*	lhd	1							
			357 955 325 A	2							
			357 955 121	1							
20	N 015 276 1	washer	6	3							
21	N 010 212 26	screw, hexagonal head	M6X12	3							
22	111 955 641	spacer F 31-J-000 001>> F >> 31-L-260 000*	rhd lhd	1 1							





Pos	Part Number	Name	Remarks	Qty	Model
		windscreen washer unit			
1	3A0 955 453	fluid container	5,0LITER	1	
2	N 903 521 01	shouldered hex. nut		5	
3	357 955 455	cover		1	
4	443 955 465	sealing washer	12X6,5	1	
5	867 955 499	packing		1	
6	333 955 651	pump		1	squareback
(6)	431 955 651	pump		1	notchback
7	1H0 955 747	bracket for hose		5	
8	357 955 747	bracket for hose		5	
9	357 955 750	angled pipe		1	
10	211 955 975	t-piece		1	
11	191 955 985 A	spraying jet		2	
12	191 955 986 A	heated spraying jet		2	
13	161 971 989 C	terminal pin housing	2 pin	2	
14	803 971 896	grommet	4X30	10	
-	N 020 301 1	hose in coils of 10m 'order unit 10'	4X1	*	
15		shorten to:	150MM	1	
16		shorten to:	370MM	1	
17		shorten to:	730MM	1	
18		shorten to:	400MM	1	
19	333 955 962	hose	3,8X2,1X150MM	1	squareback
20	867 955 961 A	tube	5X1X5600MM	1	squareback
21	N 024 399 2	clip	A7X8	1	

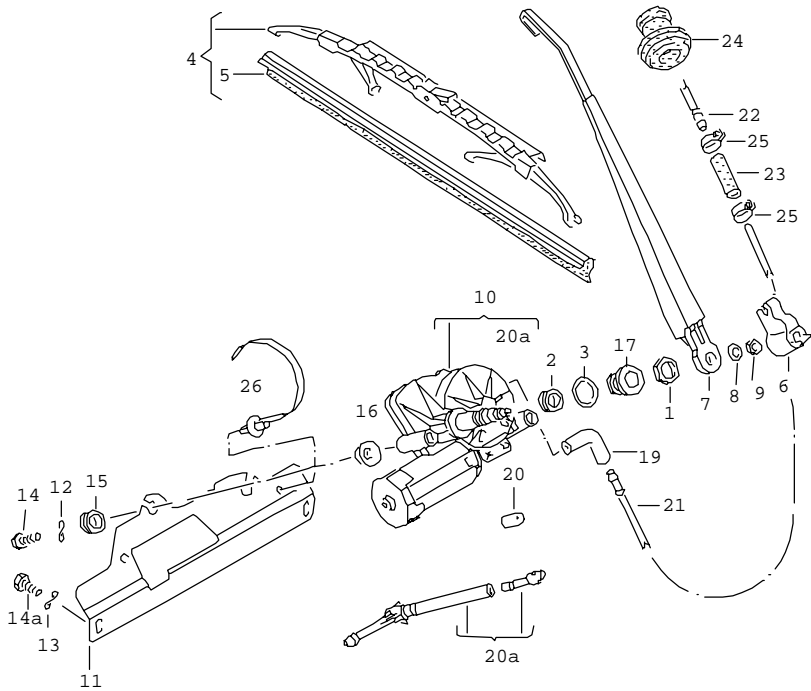
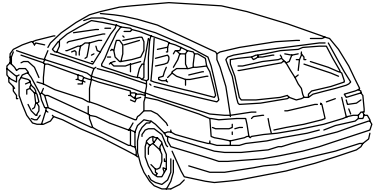

Model	Year	MG	SG	Illustration	VIN No.	Update	17:13	18.02.20100		ETKA	
PA	90	9	55	184-00		336					



Pos	Part Number	Name	Remarks	Qty	Model
		wipe and wash system for rear window			squareback
1	823 955 243 A	hex. nut	M16X1	1	
2	333 955 261	seal		1	
3	333 955 265	sealing washer F >> 31-L-400 000		1	
4	161 955 425	wiper blade	400MM	1	
5	161 955 429	rubber for wiper blade	400MM	1	
6	333 955 435	cap for wiper arm F >> 31-K-400 000		1	
(6)	333 955 435 A	cap for wiper arm F 31-L-000 001>>		1 1	
7	333 955 707 A	wiper arm		1	
8	N 011 558 11	washer	8,4X15X1,6	1	
9	N 011 151 3	hex. nut	M8	1	
(10)	333 955 713 C	wiper motor	also use: >>31-K-400000 333 955 435 A	1 1	
11	333 955 717	bracket for wiper motor F >> 31-L-400 000		1	
(11)	3A9 955 717	bracket for wiper motor F 31-M-000 001>>		1	
12	331 955 753	spring washer		2	
13	N 012 226 5	spring washer	B6	2	
14	N 010 215 27	screw, hexagonal head F >> 31-L-400 000	M6X15	2	
(14)	N 010 217 10	screw, hexagonal head F 31-M-000 001>>	M6X20	2	
(14)	N 010 217 10	screw, hexagonal head F 31-M-000 001>>	M6X20	2	
14A	N 010 215 27	screw, hexagonal head	M6X15	2	
15	331 955 754	grommet F >> 31-L-400 000	13/9	2	
(15)	701 955 754	grommet F 31-M-000 001>>	14X9,5	2	



Model	Year	MG	SG	Illustration	VIN No.	Update	17:13	18.02.20100		ETKA	
PA	90	9	55	184-00		336					

Pos	Part Number	Name	Remarks	Qty	Model	Pos	Part Number	Name	Remarks	Qty	Model
16	331 955 756	bush F	>> 31-L-400 000	2							
(16)	333 955 756 A	bush F 31-M-000 001>>		2							
17	333 955 756	bush F	>> 31-L-400 000	1							
19	333 955 665	angled pipe		1							
20	333 955 993	spraying jet F	>> 31-K-400 000	1							
20A	333 955 985	spraying jet with pipe F 31-L-000 001>>		1							
-	867 955 961 A	tube	5X1X5600MM								
21		shorten to:	2888MM	1							
22	867 955 961 A	tube	5X1X5600MM	1							
-	333 955 962	hose	3,8X2,1X150MM	1							
23		shorten to:	40MM	1							
24	171 611 751	grommet	15/4	1							
25	N 024 399 2	clip	A7X8	2							

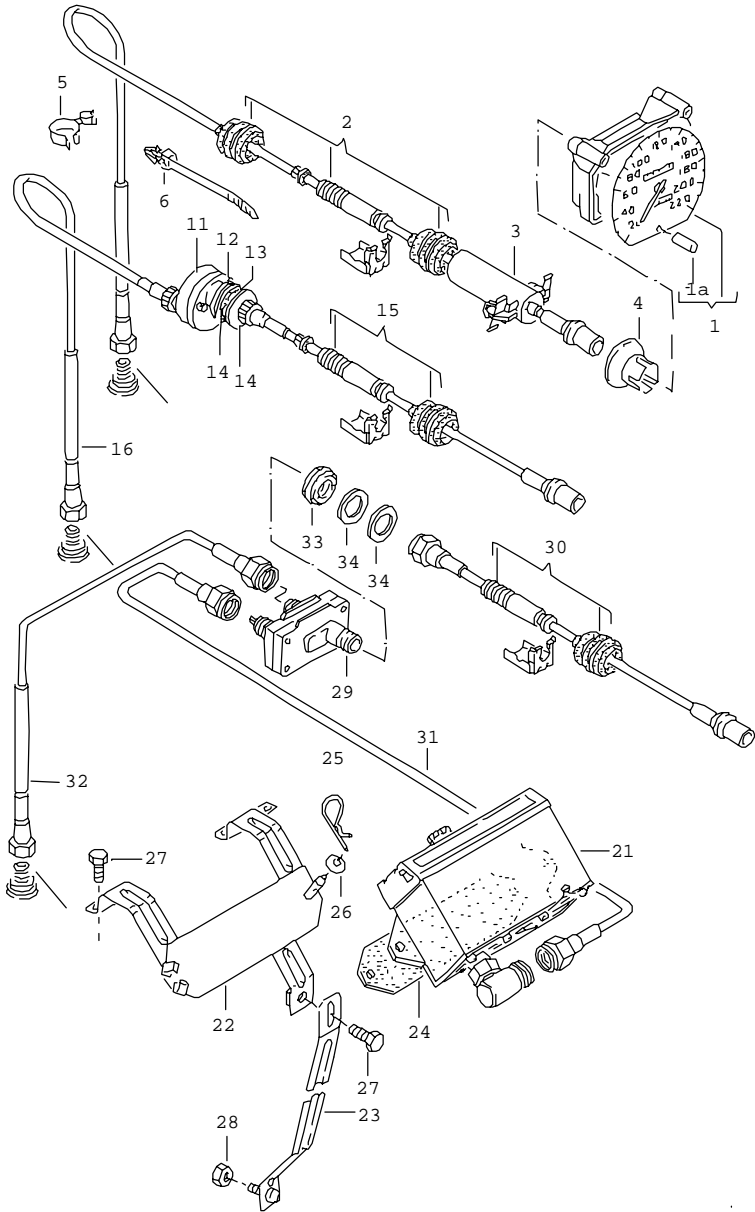

Model	Year	MG	SG	Illustration	VIN No.	Update	17:14	18.02.20100		ETKA	
PA	90	9	57	185-00		336					



Pos	Part Number	Name	Remarks	Qty	Model
		speedometer drive cables for speedometer compensating gear odometer F >> 31-L-400 000			
1	357 957 031	speedometer with kilometre trip recorder	220 KMH-W 920	1	
(1)	357 957 031 B	speedometer with kilometre trip recorder	240 KMH-W 920	1	
(1)	357 957 031 C	speedometer with kilometre trip recorder	260 KMH-W 920	1	
(1)	357 957 033	speedometer with mile trip recorder	140 MPH/ 220 KMH-W 1480	1	
(1)	357 957 033 A	speedometer with mile trip recorder	160 MPH/ 250 KMH-W 1480	1	
1A	357 957 070	knob for trip recorder km/miles		1	
2	357 957 803 A	drive cable-speedometer (transmission > speedometer) use for:	1010MM 357 957 803	1	
(2)	358 957 803 A	drive cable-speedometer (transmission > speedometer) use for:	1020MM 358 957 803	1	16V
(2)	358 957 803 G	drive cable-speedometer (transmission > speedometer) use for:	1450MM 358-803 B/C/D 358-803 E/F	1	
(2)	358 957 803 G	drive cable-speedometer (transmission > speedometer) use for:	1450MM 358-803 B/C/D 358-803 E/F	1	
3	357 957 837	sleeve drive cable-speedometer		1	



Model	Year	MG	SG	Illustration	VIN No.	Update	17:14	18.02.20100		ETKA	
PA	90	9	57	185-00		336					

Pos	Part Number	Name	Remarks	Qty	Model	Pos	Part Number	Name	Remarks	Qty	Model
4	357 919 075	seat drive cable-speedometer instrument housing		1		29	357 957 501	compensating gear	W 1002	1	
(5)	443 957 818 C	cable binder	7X273-8	1		30	357 957 805 M	drive cable-speedometer (compensating gear > speedometer)	370MM	1	
(5)	531 957 787	retainer, swivelling	7/7MM	1	rhd	31		no longer available drive cable-speedometer (compensating gear > printer)	650MM	1	
6	N 900 603 01	cable binder	6,5X175	X		32	357 957 805 L	drive cable-speedometer (transmiss. > compensat. gear)	610MM	1	
		compensating gear and drive cable for calibrated odometer			lhd	33	171 957 857	plug	28	1	
11	171 957 501	compensating gear		1		34	N 012 244 2	spring washer	B24X38X1,8	2	
12	N 011 530 1	washer	A19X34X3	1							
13	191 971 928	grommet	27	1							
14	111 405 527	washer		2							
15	357 957 805	drive cable-speedometer (compensating gear > speedometer)	380MM	1							
16	357 957 805 A	drive cable-speedometer (transmiss. > compensat. gear)	610MM	1							
		odometer drive cable-speedometer									
		odometer drive cable-speedometer									
22		no longer available bracket for odometer									
23		no longer available support bracket for odometer									
24	431 957 131	packing		1							
25	431 957 133	connector		1							
26	N 012 229 3	spring washer	A8X15X0,5	1							
27	N 014 341 1	screw, hexagonal head	M6X14	3							
28	N 011 006 24	hex. nut	M6	X							

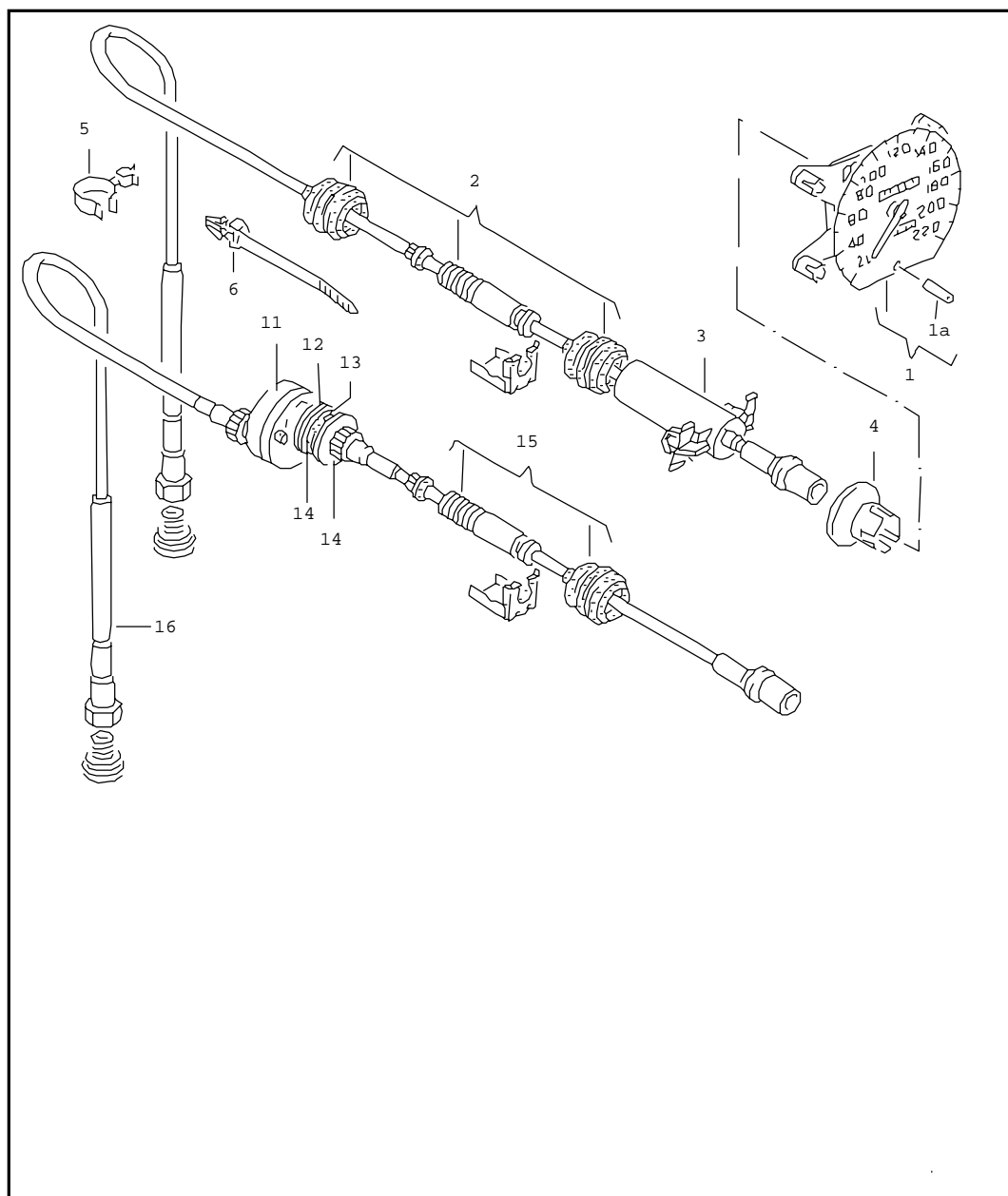
Model	Year	MG	SG	Illustration	VIN No.	Update	17:14	18.02.20100		ETKA	
PA	90	9	57	185-10		336					





Pos	Part Number	Name	Remarks	Qty	Model
		speedometer drive cables for speedometer F 31-M-000 001>>			
1	357 957 031 D	speedometer with kilometre trip recorder	220 KMH-W 920	1	
(1)	357 957 031 E	speedometer with kilometre trip recorder use for:	260 KMH-W 920 240 KMH-W 920	1	
(1)	357 957 033 D	speedometer with mile trip recorder	140 MPH/ 220 KMH-W 1480	1	
(1)	357 957 033 C	speedometer with mile trip recorder	160 MPH/ 250 KMH-W 1480	1	
1A	357 957 070	knob for trip recorder km/miles		1	
2	357 957 803 A	drive cable-speedometer (transmission > speedometer) use for:	1010MM lhd 357 957 803	1	
(2)	358 957 803 A	drive cable-speedometer (transmission > speedometer) use for:	1020MM rhd 358 957 803	1	16V
(2)	358 957 803 G	drive cable-speedometer (transmission > speedometer) use for:	1450MM rhd 358-803 B/C/D 358-803 E/F	1	
3	357 957 837	sleeve drive cable-speedometer		1	
4	357 919 075	seat drive cable-speedometer instrument housing		1	
(5)	443 957 818 C	cable binder	7X273-8	1	
(5)	531 957 787	retainer, swivelling	7/7MM rhd	1	
6	N 900 603 01	cable binder	6,5X175	X	

Model	Year	MG	SG	Illustration	VIN No.	Update	17:14	18.02.20100		ETKA	
PA	90	9	57	185-10		336					

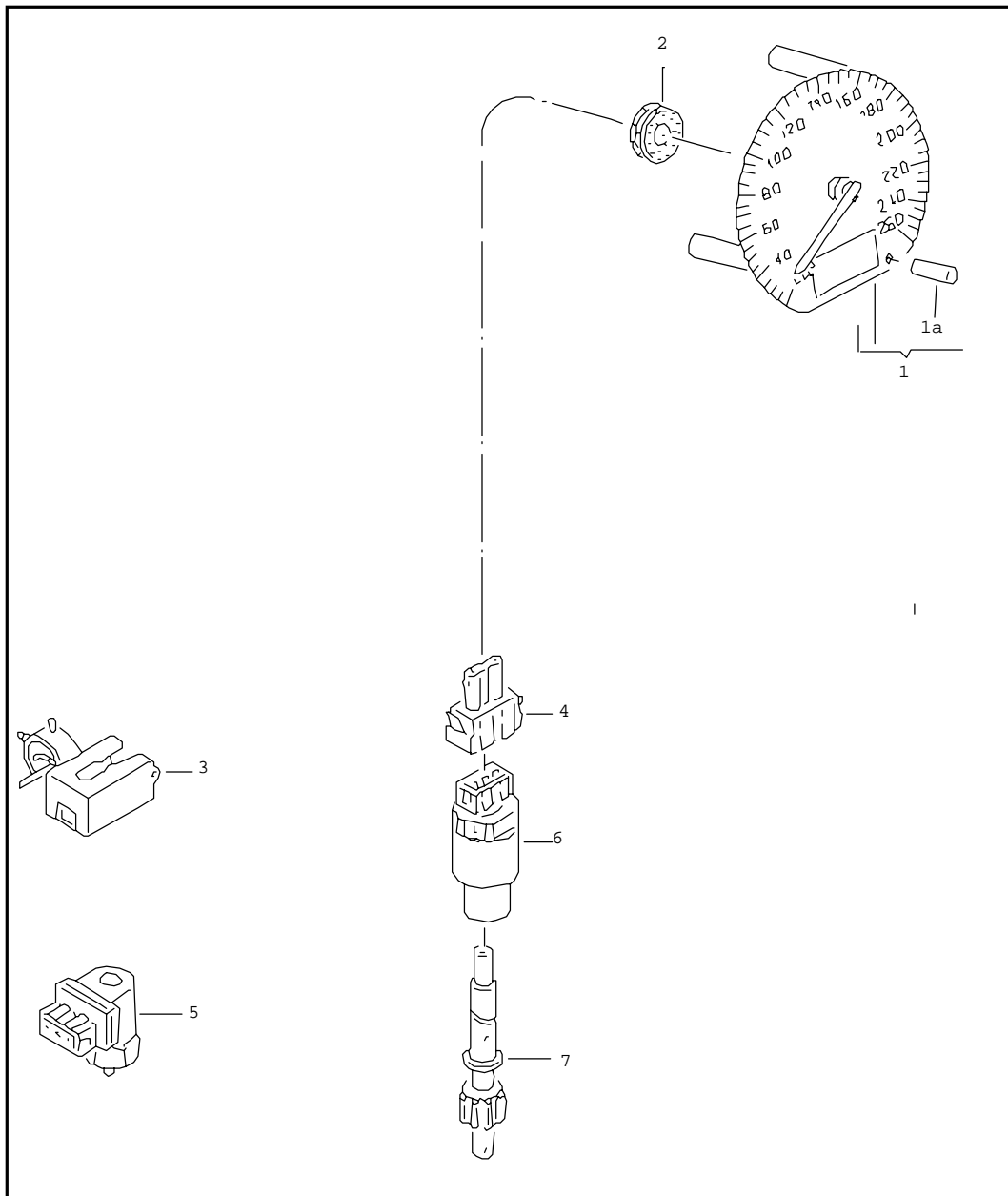
Pos	Part Number	Name	Remarks	Qty	Model	Pos	Part Number	Name	Remarks	Qty	Model
		compensating gear and drive cable for calibrated odometer	lhd								
11	171 957 501	compensating gear		1							
12	N 011 530 1	washer	A19X34X3	1							
13	191 971 928	grommet	27	1							
14	111 405 527	washer		2							
15	357 957 805	drive cable-speedometer (compensating gear > speedometer)	380MM	1							
16	357 957 805 A	drive cable-speedometer (transmiss. > compensat. gear)	610MM	1							



Pos	Part Number	Name	Remarks	Qty	Model
		speedometer distance sensor for vehicles with multi function indicator F 31-M-000 001>>	electronic		
(1)	701 957 031 AA	speedometer with aperture for kilometre trip recorder	220 KMH	1	
1	357 957 031 AC	speedometer with aperture for kilometre trip recorder	260 KMH	1	
(1)	357 957 031 AE	speedometer with aperture for kilometre trip recorder	240 KMH	1	
(1)	357 957 033 AC	speedometer with aperture for mile trip recorder	140 MPH/ 220 KMH-	1	
(1)	357 957 033 AB	speedometer with aperture for mile trip recorder	160 MPH/ 250 KMH	1	
1A	357 957 070	knob for trip recorder km/miles		1	
2	191 971 928	grommet	27	2	
3	701 957 845	retainer, swivelling with cap for seal	24MM	1	
4	357 972 753	flat contact housing for contact:	3 pin N 903 352 03 N 903 353 03	1 X X	
5	191 919 149 D	distance sensor	3 pin	1	
6	357 919 149	distance sensor	3 pin	1	automatic
7		drive gear-speedometer see illustration:	71,71-10		
7		drive gear-speedometer see illustration:	71,71-10		

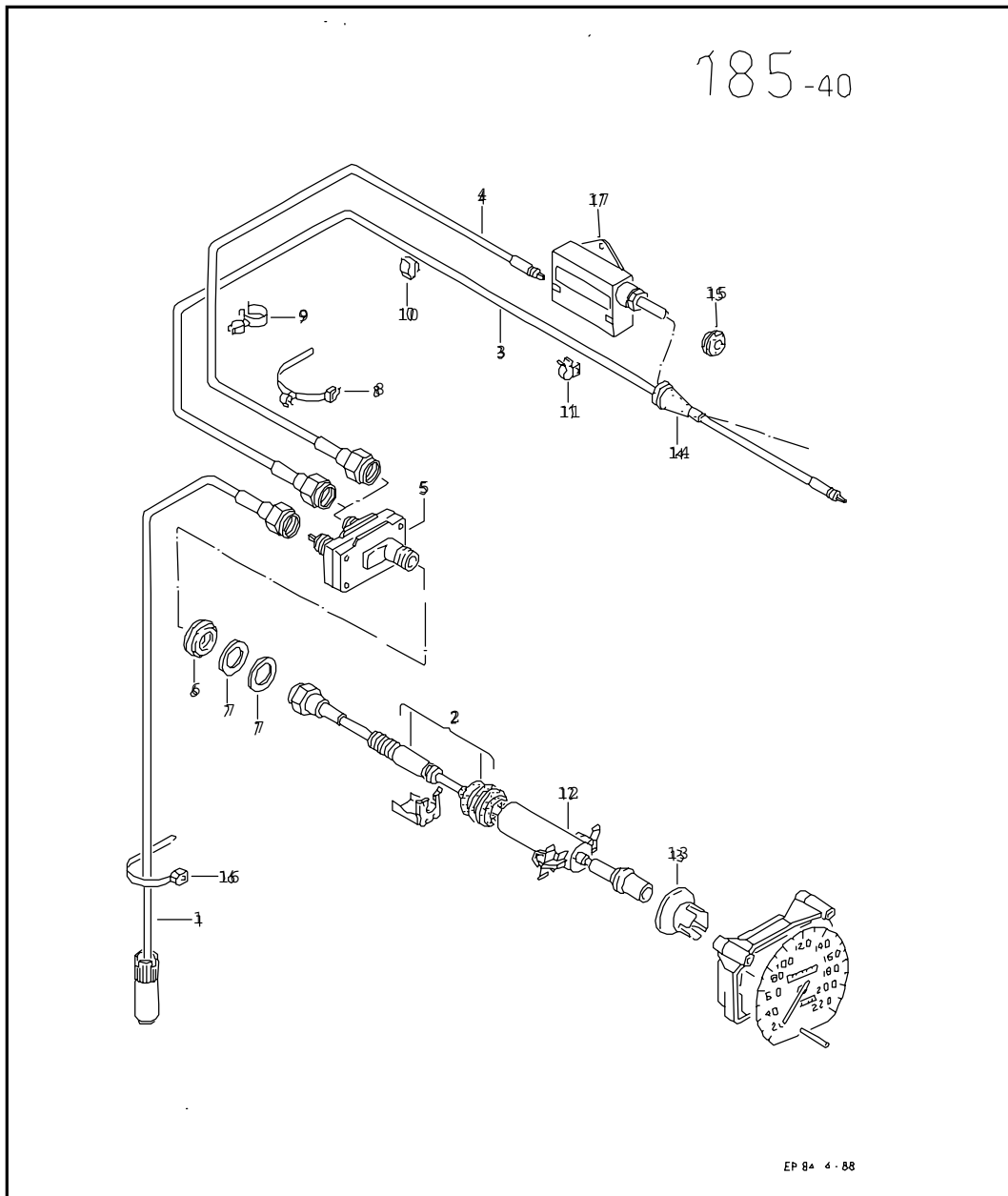

Model	Year	MG	SG	Illustration	VIN No.	Update	17:14	18.02.20100		ETKA	
PA	90	9	57	185-40		336					



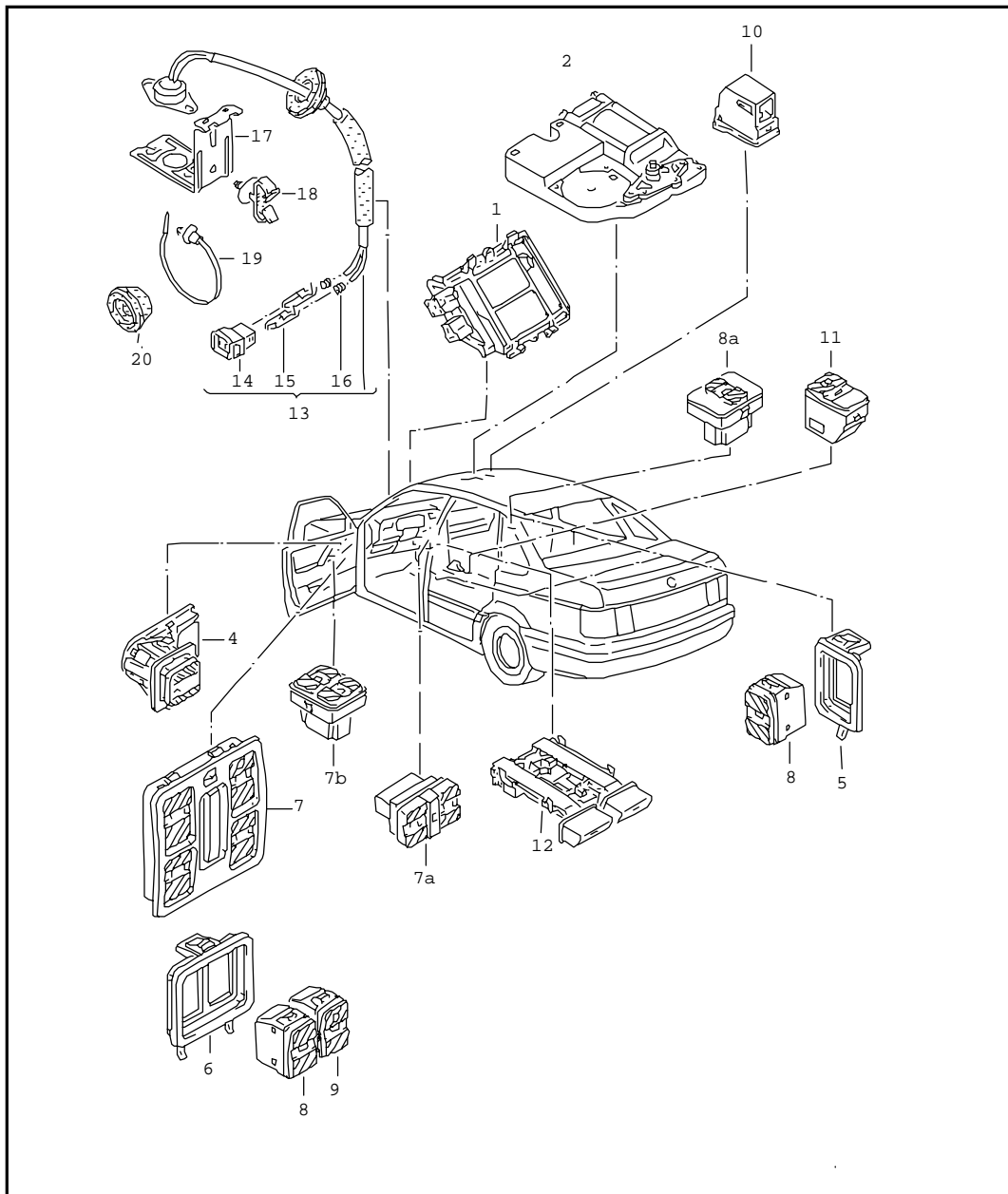

Pos	Part Number	Name	Remarks	Qty	Model
		drive cables for taxameter, mechanical	lhd		TAXI
		drive cables for taxameter, electric			
1	357 957 805 L	drive cable-speedometer (transmiss. > compensat. gear)	610MM	1	
2	357 957 805 M	drive cable-speedometer (compensating gear > speedometer)	370MM	1	
3	357 957 805 P	drive cable-speedometer (compensating gear > taximeter)	2350MM	1	
4	357 957 805 N	drive cable-speedometer (compensating gear > taximeter) impulse sender	1650MM electronic	1	
5	357 957 501	compensating gear	W 1002	1	
6	171 957 857	plug	28	1	
7	N 012 244 2	spring washer	B24X38X1,8	2	
8	443 957 818 C	cable binder	7X273MM/	1	
9	049 127 621	bracket retainer, swivelling		1	
10	803 959 849	bracket		1	
11	155 971 898	clip		1	
12	357 957 837	sleeve drive cable-speedometer		1	
13	357 919 075	seat drive cable-speedometer instrument housing		1	
14	411 941 189	grommet	20/4	1	
15	191 971 908 B	plug	19,5	X	
(16)	N 020 902 2	cable binder	6X246	X	
17		impulse sender not a spare part			



Pos	Part Number	Name	Remarks	Qty	Model
1	357 959 263	series resistance electric fan motor		1	
(1)	358 959 263	series resistance	lhd	1	
			rhd	1	
4	357 959 565 A	switch for rear view mirror electrically operated		1	
	4/88 7/91 01C	satin black	lhd	1	
(4)	358 959 565	switch for rear view mirror electrically operated		1	
	4/88 7/91 01C	satin black	rhd	1	
5	357 959 550	switch for electric windows		3	
		switch bracket		2	
		F >> 31-L-400 000			
		F 31-M-000 001>>			
	4/88 7/91 01C	satin black			
6	535 959 550	switch bracket switch for electric windows (drivers side)		1	
		F >> 31-L-400 000			
	4/88 7/90 01C	satin black			
	4/88 7/90 01C	satin black			
7A	357 959 855 K	safety switch for electric window lifters	rear	1	
		F 31-M-000 001>>			
	8/90 7/91 01C	satin black			
7B	535 959 855 D	switch for electric windows (drivers side)	front	1	
		F 31-M-000 001>>			



Model	Year	MG	SG	Illustration	VIN No.	Update	17:15	18.02.20100		ETKA	
PA	90	9	59	186-00		336					

Pos	Part Number	Name	Remarks	Qty	Model	Pos	Part Number	Name	Remarks	Qty	Model
	8/90 7/91 01C	satin black				12	357 959 543	switch for air conditioner		1	
(8)	357 959 855 A	switch for electric windows F >> 31-K-155 000*		3			4/88 7/91 01C	satin black			
	4/88 2/89 01C	satin black				13	893 959 625	temperature switch	also use:	1	
8	357 959 855 F	switch for electric windows F 31-K-155 001>> 31-L-400 000 F 31-M-000 001>>		3					357 972 741	2	
	2/89 7/91 01C	satin black		2					357 972 752	1	
8A	535 959 855 C	switch for electric windows (passenger side) F 31-M-000 001>>		1					N 903 352 03	2	
	8/90 7/91 01C	satin black				14	357 972 752	flat contact housing	2 pin	1	
9	357 959 855 G	switch for electric windows F >> 31-L-400 000		1		15	N 903 352 03	flat contact	3,5-1	2	
	4/88 7/90 01C	satin black				16	357 972 741	single wiring seal	5,6X7,8 blue	2	
	4/88 7/90 01C	satin black							for wire cross section:	1,0	
		switch for electric sliding roof				17	357 959 637	bracket for switch		1	
10	357 959 855 B	switch for electric sliding roof		1		18	1H0 971 899 B	bracket		1	
	4/88 7/91 01C	satin black				19	N 902 055 01	cable binder	4,5X140	1	
11	357 959 855 H	switch for 4 speed automatic gearbox F >> 31-L-200 000*		1		20	311 971 907	grommet	23,5/4	1	
	4/89 7/91 01C	satin black									
(11)		see illustration: 169-70 F 31-L-200 000>>*		1							
		switch temperature switch									air condit.

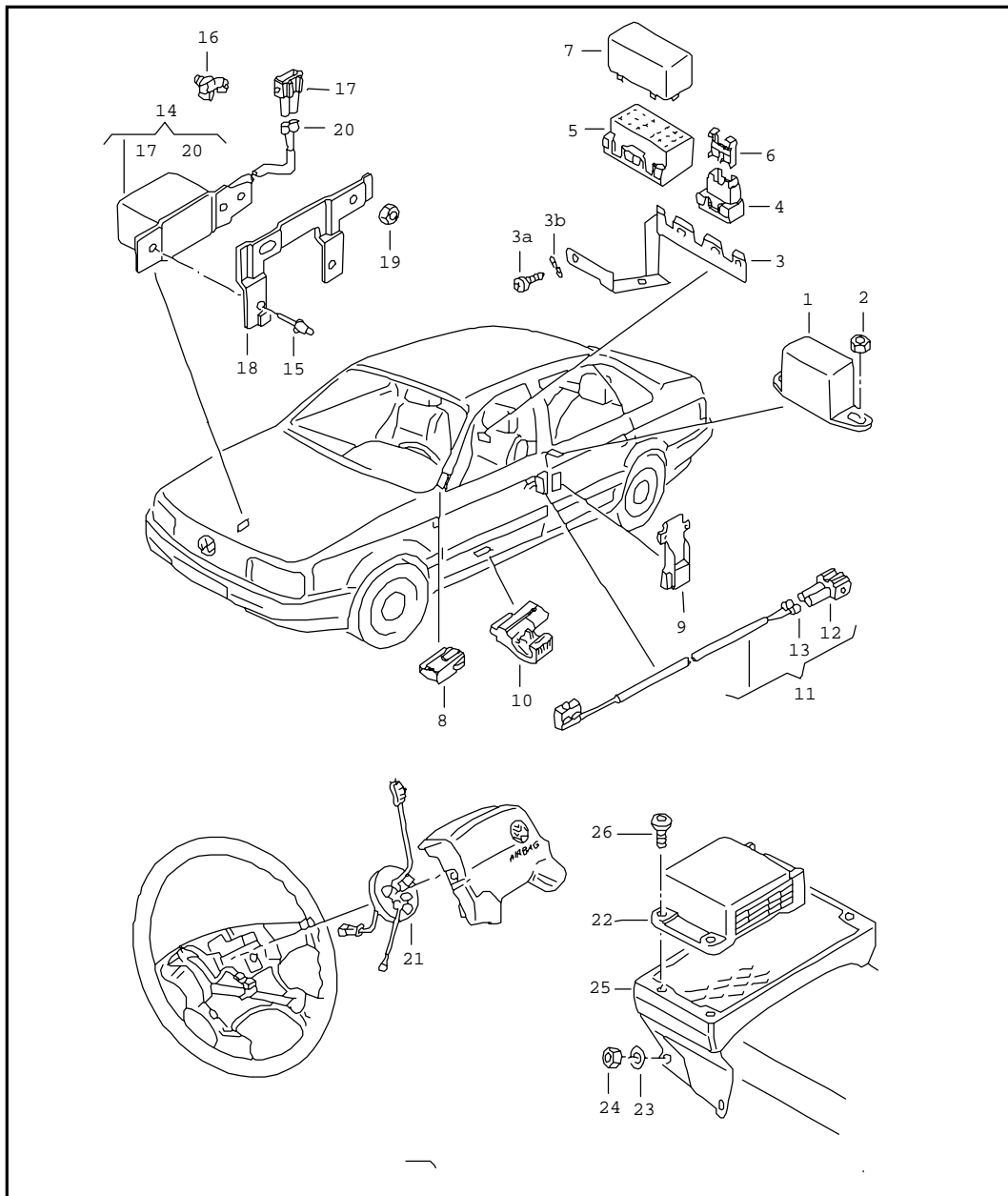
Model	Year	MG	SG	Illustration	VIN No.	Update	17:15	18.02.20100		ETKA	
PA	90	9	59	186-05		336					



Pos	Part Number	Name	Remarks	Qty	Model
		switch electr. pass. restraint system	-ELRA-		"D.."
1	357 959 661	sender for timed seat belt lock		1	
2	171 201 969	shouldered hex. nut		2	
3	357 972 595 B	bracket relay plate		2	
3A	N 014 129 13	fill. hd. screw, self locking	M5X10	4	
3B	N 012 225 3	spring washer	B5X11X0,5	4	
4	161 937 501	fuse box for flat fuses	2 pin	1	
5	357 937 501	relay plate	18 pin	1	
6	N 017 131 3	flat fuse	19/2x5 5-light brown	1	
7	357 959 663	control unit for seat belt adjustment		2	
8	535 959 665	switch	front	2	
9	535 959 689	switch	rear	2	
10	357 959 673	switch for solenoid	left	1	
(10)	357 959 674	switch for solenoid	right	1	
11	535 947 559	micro switch		2	
12	357 972 762	flat connector housing	2 pin	2	
13	357 972 741 A	single wiring seal	5,6X7,8 red for wire cross section: 1,5	4	
14	357 959 671	switch three-point automatic seat belt with belt tensioner solenoid for seat belt lock		2	
15	N 016 194 3	pop-rivet	A4,8X7,6	4	
16	1H0 971 899 B	bracket flat contact housing		2	
17	357 972 762	flat connector housing	2 pin	2	

Model	Year	MG	SG	Illustration	VIN No.	Update	17:15	18.02.20100		ETKA	
PA	90	9	59	186-05		336					

Pos	Part Number	Name	Remarks	Qty	Model	Pos	Part Number	Name	Remarks	Qty	Model
18	357 959 669	bracket	left	1							
(18)	357 959 670	bracket	right	1							
19	N 903 521 01	shouldered hex. nut	5	4							
20	357 972 741 A	single wiring seal	5,6X7,8 red for wire cross section: 1,5	2							

electric fan versions

>>3-M-033271

EZ, KR, RF, 9A

1F, PB, PF, RP

2E, SB, RA, AA



>>31-M-340000

1Y

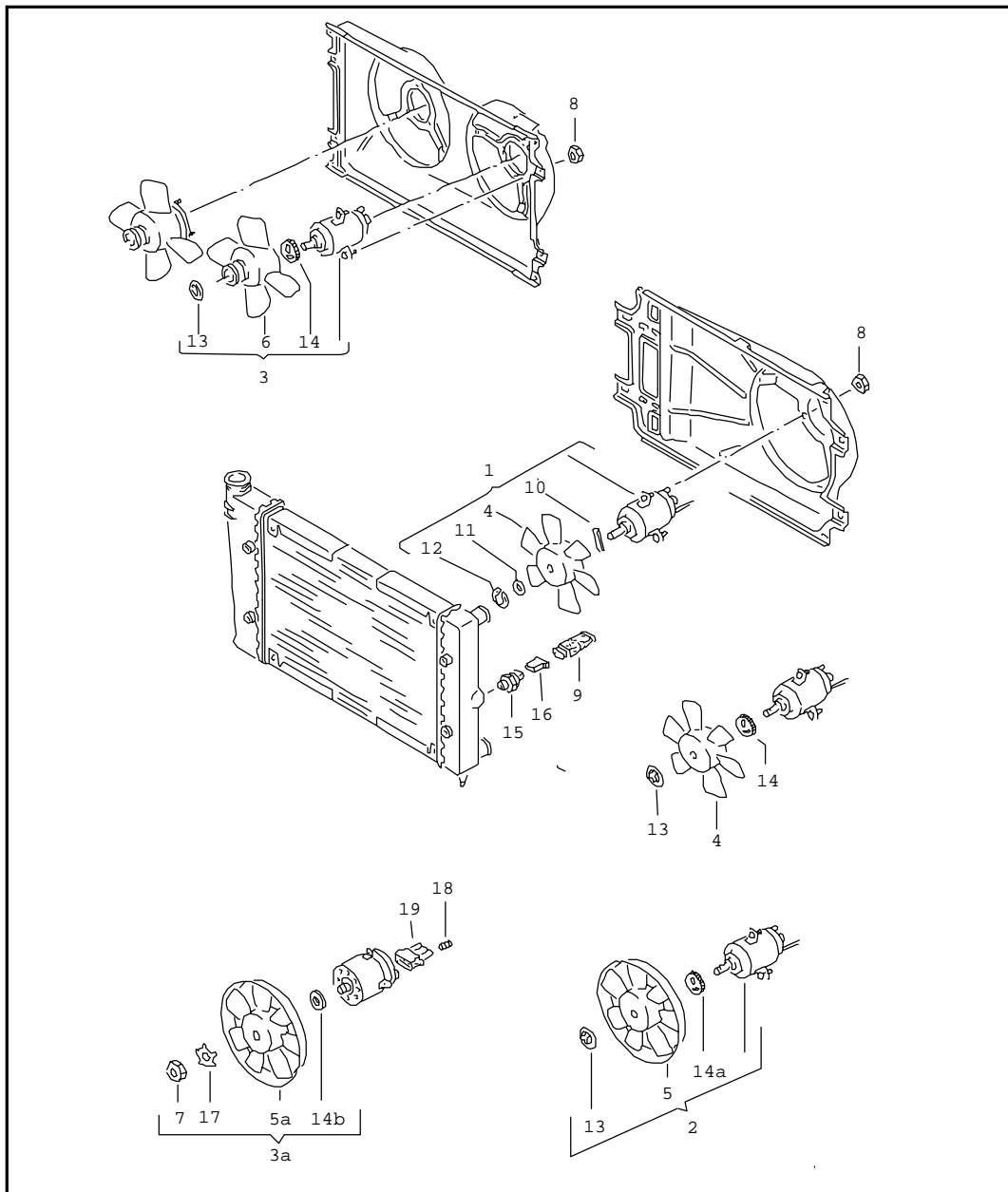

1	191 959 455 H	100/60W	280MM	also use see no.:	3	165 959 455 T
2	191 959 455 J	100/60W	280MM	also use see no.:	3	165 959 455 T
3	191 959 455 AK	100/60W K	305MM			1H0 959 455 +1H0 906 233 +357 972 742 A +357 972 742 B
4	191 959 455 AT	100/60W T	305MM	also use see no.:	3	1H0 959 455
5	191 959 455 AF	250/150W F	305MM	also use see no.:	3	1H0 959 455 D
6	191 959 455 AP	250/150W P	305MM	also use see no.:	3	1H0 959 455 D
7	357 959 455	250/150W	280MM	also use see no.:	3	353 959 455 D
8	357 959 455 A	250/150W	280MM	also use see no.:	3	353 959 455 D
9	323 959 455	150/60W	280MM	also use see no.:	3	327 959 455 A
10	323 959 455 B	150/60W	280MM	also use see no.:	3	327 959 455 A
11	327 959 455	150/60W	280MM	also use see no.:	3	327 959 455 A
12	191 959 455 Q	200/120W	280MM	also use see no.:	3	165 959 455 T





Pos	Part Number	Name	Remarks	Qty	Model
		electric fan F >> 31-M-033 271			EZ, KR, RF, 9A, 1F, PB, PF, RP, 2E, SB, RA, AAM 1Y
		F >> 31-M-340 000*			
1	165 959 455 T	electric fan	200/120W 280MM AEG	1	1F, EZ, RF
(1)	165 959 455 T	electric fan for manual gearbox	200/120W 280MM AEG	1	RP, PB, PF, AAM
(3)	353 959 455 D	electric fan for automatic gearbox	250/150W 280MM AEG	1	RP, PB, PF, AAM
2	1H0 959 455 D	electric fan	250/150W 305MM AEG	1	RA, SB
(2)	1H0 959 455	electric fan	100/60W 305MM AEG	1	KR, 9A, 2E
(3)	327 959 455 A	electric fan	150/80W 280MM	1	1Y
		electric fan for trailer towing for vehicle use in warm countries F >> 31-M-033 271			EZ, KR, PF, 9A, 1F, PB, PF, RP, 2E, SB, RA, AAM 1Y
		F >> 31-M-340 000*			
2	1H0 959 455 D	electric fan	250/150W 305MM AEG	1	EZ, KR, RF, 1F
(2)	1H0 959 455 D	electric fan	250/150W 305MM AEG	1	PB, PF, RP, AAM
(3)	353 959 455 D	electric fan for automatic gearbox	250/150W 280MM AEG	1	PB, PF, RP, 9A, AAM
(3)	327 959 455 A	electric fan for manual gearbox	150/80W 280MM	1	9A, 2E

Model	Year	MG	SG	Illustration	VIN No.	Update	19:26	18.02.20100		ETKA	
PA	90	9	59	187-00		336					



Pos	Part Number	Name	Remarks	Qty	Model
		electric fan for trailer towing for vehicle use in warm countries F >> 31-M-033 271			EZ, KR, PF, 9A, 1F, PB, PF, RP, 2E, SB, RA, AAM 1Y
		F >> 31-M-340 000*			
(3)	327 959 455 A	electric fan for manual gearbox	150/80W 280MM	1	9A, 2E
(3)	353 959 455 D	electric fan	250/150W 280MM AEG	1	RA, 1Y, SB
		electric fan F >> 31-M-033 271			police TAXI; hire car PB, PF, RP, EZ, 1F, SB, RA, 9A, AAM 1Y
		F >> 31-M-340 000*			
(2)	1H0 959 455 D	electric fan for automatic gearbox	250/150W 305MM AEG	1	PB, PF, RP, AAM
(2)	1H0 959 455 D	electric fan	250/150W 305MM AEG	1	9A
(3)	353 959 455 D	electric fan for manual gearbox	250/150W 280MM AEG	1	PB, PF, AAM
(3)	327 959 455 A	electric fan for manual gearbox	150/80W 280MM	1	RP
(3)	353 959 455 D	electric fan for vehicles with air condit.	250/150W 280MM AEG	1	RA, 1Y, SB
(3)	327 959 455 A	electric fan	150/80W 280MM	1	RF, EZ, 1F

Model	Year	MG	SG	Illustration	VIN No.	Update	19:26	18.02.20100		ETKA	
PA	90	9	59	187-00		336					

Pos	Part Number	Name	Remarks	Qty	Model
		electric fan air condit. F >> 31-M-033 271			EZ, KR, RF, 9A, 1F, PB, PF, RP, 2E, SB, RA, AAM 1Y
		F >> 31-M-034 000*			
(3)	327 959 455 A	electric fan	150/80W 280MM	1	KR, 1F, RF, EZ
(3)	327 959 455 A	electric fan for manual gearbox	150/80W 280MM	1	RP
(3)	327 959 455 A	electric fan for trailer towing	150/80W 280MM	1	PF, PB, AAM
(3)	353 959 455 D	electric fan for automatic gearbox	250/150W 280MM AEG	1	PF, PB, RP, AAM
(3)	353 959 455 D	electric fan for trailer towing	250/150W 280MM AEG	1	RP, 2E
3	353 959 455 D	electric fan	250/150W 280MM AEG	1	RA, 1Y, SB, 2E
3	357 959 455 F	electric fan	250/80W 303MM AEG	1	9A
(2)	1H0 959 455 D	electric fan for manual gearbox	250/150W 305MM AEG	1	PF, PB
		fan wheel F >> 31-M-033 271			EZ, KR, RF, 9A, 1F, PB, PF, RP, 2E, SB, RA, AAM 1Y
		F >> 31-M-340 001*			
4	191 959 465	fan wheel for electric fan:	280MM BOSCH 1,2,12	1	
(4)	191 959 465 A	fan wheel for electric fan:	280MM AEG 1,2,12	1	

Model	Year	MG	SG	Illustration	VIN No.	Update	19:27	18.02.20100		ETKA	
PA	90	9	59	187-00		336					

Pos	Part Number	Name	Remarks	Qty	Model
		fan wheel F >> 31-M-033 271			EZ, KR, RF, 9A, 1F, PB, PF, RP, 2E, SB, RA, AAM 1Y
		F >> 31-M-340 001*			
5	191 959 465 D	fan wheel for electric fan:	305MM AEG 3,5	1	
(5)	191 959 465 C	fan wheel for electric fan:	305MM BOSCH 4,6	1	
6	811 959 465 B	fan wheel with v-belt pulley for electric fan:	280MM AEG 7,9,11	1	
(6)	811 959 465 C	fan wheel with v-belt pulley for electric fan:	280MM BOSCH 8,10	1	
8	N 901 752 03	shouldered hex. nut	M6	3	
9	867 972 525 B	grommet	26X13	1	
10	823 959 469	pin for electric fan:	BOSCH 1,2,4,6,8,10, 12	1	
11	N 011 670 16	washer for electric fan:	B8,4X24X2 BOSCH 1,2,4,6,8,10, 12	1	
12	823 959 473	lock washer for electric fan:	BOSCH 1,2,4,6,8,10, 12	1	
13	431 959 471	clamping washer for electric fan:	AEG 1,2,3,5,7,9, 11,12	1	
14	431 959 473	shake-proof washer for electric fan:	AEG 1,2,7,9,11,12,	1	

Model	Year	MG	SG	Illustration	VIN No.	Update	19:27	18.02.20100		ETKA	
PA	90	9	59	187-00		336					

Pos	Part Number	Name	Remarks	Qty	Model
		fan wheel F >> 31-M-033 271			EZ, KR, RF, 9A, 1F, PB, PF, RP, 2E, SB, RA, AAM 1Y
		F >> 31-M-340 001*			
14A	191 959 473	shake-proof washer for electric fan:	3,5 AEG	1	
15	191 959 481 C	dual thermo-switch	95-84C/102-91C 3 pin	1	
-	1H0 906 233	flat contact housing	3 pin	1	
-	357 972 742 A	single wiring seal for wire cross section:	9,0X7,8 white 1,5	X	
-	357 972 742 B	single wiring seal for wire cross section:	9,0X7,8 red 2,5	X	



electric fan versions

31-M-033272>>

**EZ, 2E, KR, 9A
SB, AAM, AAA,
RP, AAZ
1Y**



31-M-40001>>

1	165 959 455 K	100/60W	AEG	280MM	165 959 455 L
2	165 959 455 L	100/60W	AEG	280MM	165 959 455 L
3	165 959 455 M	100/60W	BOSCH	280MM	165 959 455 L
4	165 959 455 N	100/60W	BOSCH	280MM	165 959 455 L
5	165 959 455 AA	200/120W A	AEG	280MM	165 959 455 T
6	165 959 455 T	200/120W	AEG	280MM	165 959 455 T
7	1H0 959 455	100/60W	AEG	305MM	1H0 959 455
8	1H0 959 455 A	100/60W	BOSCH	305MM	1H0 959 455
9	1H0 959 455 B	200/120W	AEG	305MM	1H0 959 455 D
10	1H0 959 455 C	200/120W	BOSCH	305MM	1H0 959 455 D
11	1H0 959 455 D	250/150W	AEG	305MM	1H0 959 455 D
12	1H0 959 455 E	250/150W	BOSCH	305MM	1H0 959 455 D
13	327 959 455 A	150/80W	AEG	280MM	327 959 455 A
14	353 959 455 B	150/80W	AEG	280MM	327 959 455 A
15	353 050 455 C	150/80W	BOSCH	280MM	327 959 455 A
16	357 959 455 F	250/80W	AEG	303MM	357 959 455 F
17	357 959 455 H	450/250/80W	BOSCH	304MM	357 959 455 H
18	357 959 455 J	350/250/80W	BOSCH	304MM	357 959 455 J
19	353 959 455 E	250/80W	BOSCH	280MM	353 959 455 D
20	353 959 455 D	250/80W	AEG	280MM	353 959 455 D
21	357 959 455 L	450/250/80W	BOSCH	280MM	357 959 455 L

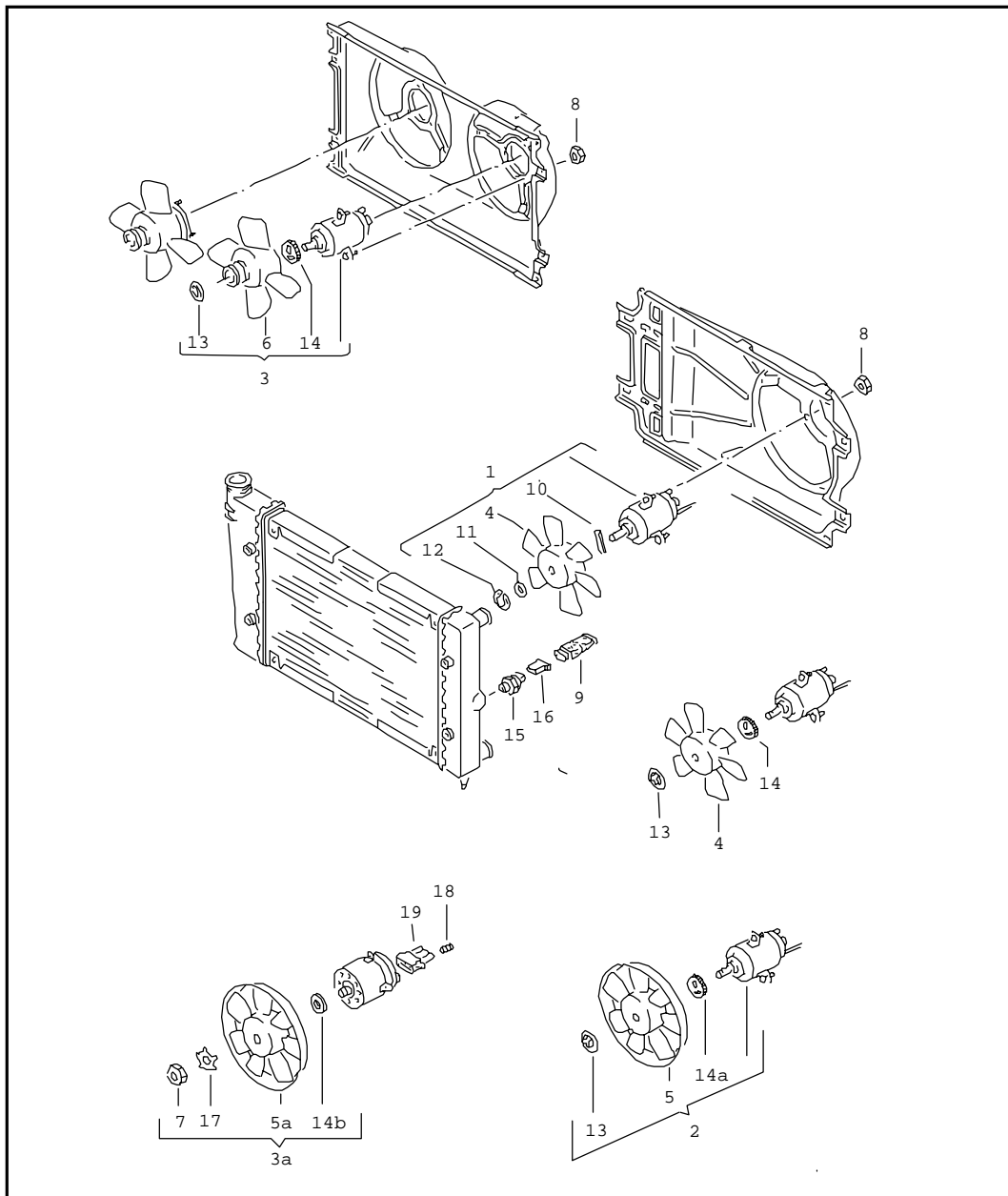

Model	Year	MG	SG	Illustration	VIN No.	Update	19:17	18.02.20100		ETKA	
PA	90	9	59	187-50		336					





Pos	Part Number	Name	Remarks	Qty	Model
		electric fan F 31-M-033 272>>			EZ,RP,KR,9A, 2E,SB,AAA, AAZ,AAM 1Y
		F 31-M-340 001>>*			
1	165 959 455 L	electric fan	100/60W 280MM AEG	1	EZ,AAM,RP
2	1H0 959 455	electric fan	100/60W 305MM AEG	1	KR,2E,9A
3	327 959 455 A	electric fan	150/80W 280MM AEG	1	SB
(3A)	357 959 455 F	electric fan for manual gearbox	250/80W 303MM AEG	1	AAA,AAZ,1Y
3A	357 959 455 J	electric fan for automatic gearbox	350/250/80W 303MM BOSCH	1	AAA,AAZ
		electric fan for trailer towing for vehicle use in warm countries F 31-M-033 272>>			EZ,RP,KR,9A, 2E,SB,AAA, AAZ,AAM 1Y
		F 31-M-340 001>>*			
(2)	1H0 959 455 D	electric fan	250/150W 305MM AEG	1	EZ,AAM,RP, KR,2E
(3)	327 959 455 A	electric fan for manual gearbox	150/80W 280MM AEG	1	9A
(3)	353 959 455 D	electric fan for automatic gearbox	250/150W 280MM AEG	1	9A
(3A)	357 959 455 F	electric fan	250/80W 303MM AEG	1	SB

Model	Year	MG	SG	Illustration	VIN No.	Update	19:28	18.02.20100		ETKA	
PA	90	9	59	187-50		336					



Pos	Part Number	Name	Remarks	Qty	Model
		electric fan for trailer towing for vehicle use in warm countries F 31-M-033 272>> F 31-M-340 001>>*			EZ, RP, KR, 9A, 2E, SB, AAA, AAZ, AAM 1Y
(3A)	357 959 455 J	electric fan for manual gearbox	350/250/80W 303MM BOSCH	1	AAA, AAZ, 1Y
(3A)	357 959 455 H	electric fan for automatic gearbox	450/250/80W 304MM BOSCH	1	AAA, AAZ
		electric fan air condit. F 31-M-033 272>> F 31-M-340 001>>*			RP, KR, 2E, 9A, AAM, AAA, AAZ, SB 1Y
(3)	327 959 455 A	electric fan	150/80W 280MM AEG	1	AAM, RP, KR, EZ
(3)	353 959 455 D	electric fan	250/150W 280MM AEG	1	2E
(3A)	357 959 455 F	electric fan	250/80W 303MM AEG	1	9A; automatic: 2E
(3A)	357 959 455 H	electric fan	450/250/80W 304MM BOSCH	1	AAA, AAZ, SB
		electric fan F 31-M-033 272>> F 31-M-340 001>>*			police TAXI; hire car RP, KR, 2E, 9A, AAM, AAA, AAZ, SB 1Y

Model	Year	MG	SG	Illustration	VIN No.	Update	19:28	18.02.20100		ETKA	
PA	90	9	59	187-50		336					



Pos	Part Number	Name	Remarks	Qty	Model
		electric fan F 31-M-033 272>> F 31-M-340 001>>*			police TAXI; hire car RP, KR, 2E, 9A, AAM, AAA, AAZ, SB 1Y
(3)	327 959 455 A	electric fan	150/80W 280MM AEG	1	AAM, RP, KR, 2E 9A
(3A)	357 959 455 F	electric fan	250/80W 303MM AEG	1	SB
(3A)	357 959 455 H	electric fan for automatic gearbox	450/250/80W 304MM BOSCH	1	AAA, AAZ
(3A)	357 959 455 J	electric fan for manual gearbox	350/250/80W 304MM BOSCH	1	AAZ, 1Y
		fan wheel F 31-M-033 272>> F 31-M-340 001>>*			EZ, RP, KR, 9A, AAA, AAZ, AAM, SB, 2E 1Y
4	191 959 465	fan wheel for electric fan:	280MM BOSCH 3, 4, 5	1	
(4)	191 959 465 A	fan wheel for electric fan:	280MM AEG 1, 2, 6	1	
5	191 959 465 C	fan wheel for electric fan:	305MM BOSCH 8, 10, 12	1	
(5)	191 959 465 D	fan wheel for electric fan:	305MM AEG 7, 9, 11	1	
(5)	191 959 465 C	fan wheel for electric fan:	305MM BOSCH 8, 10, 12	1	
(5A)	357 959 465	fan wheel for electric fan:	303MM BOSCH 17, 18	1	

Model	Year	MG	SG	Illustration	VIN No.	Update	19:29	18.02.20100		ETKA	
PA	90	9	59	187-50		336					

Pos	Part Number	Name	Remarks	Qty	Model
		fan wheel F 31-M-033 272>>			EZ, RP, KR, 9A, AAA, AAZ, AAM, SB, 2E
		F 31-M-340 001>>*			1Y
(5A)	357 959 465	fan wheel for electric fan:	303MM BOSCH 17,18	1	
5A	357 959 465 A	fan wheel with v-belt pulley for electric fan:	303MM BOSCH 21	1	
6	811 959 465 B	fan wheel with v-belt pulley for electric fan:	280MM AEG 13,14,20	1	
(6)	811 959 465 C	fan wheel with v-belt pulley for electric fan:	280MM BOSCH 15,19	1	
7	701 959 484	hex. nut for electric fan:	17,18	1	
(7)	1H0 959 484	hex. nut for electric fan:	21	1	
8	N 901 752 03	shouldered hex. nut	M6	3	
9	867 972 525 B	grommet	26X13	1	
10	823 959 469	pin	BOSCH	1	
11	N 011 670 16	washer	B8,4X24X2 BOSCH	1	
12	823 959 473	lock washer	BOSCH	1	
13	431 959 471	clamping washer	AEG	1	
14	431 959 473	shake-proof washer for electric fan:	AEG 1,2,6,13,14	1	
14A	191 959 473	shake-proof washer for electric fan:	AEG 7,9,11	1	

Model	Year	MG	SG	Illustration	VIN No.	Update	19:30	18.02.20100		ETKA	
PA	90	9	59	187-50		336					

Pos	Part Number	Name	Remarks	Qty	Model
		fan wheel F 31-M-033 272>>			EZ, RP, KR, 9A, AAA, AAZ, AAM, SB, 2E 1Y
		F 31-M-340 001>>*			
14A	191 959 473	shake-proof washer for electric fan:	7,9,11 AEG	1	
14B	701 959 477	spacer bush for electric fan:	12X18X2 BOSCH 17,18	1	
(15)	191 959 481 B	thermo switch	95C-84C 2 pin	1	
15	191 959 481 C	dual thermo-switch	95-84C/102-91C 3 pin	1	
16	893 906 231	terminal pin housing	3 pin	1	
17	701 959 473	lock washer for electric fan:	17,18	1	
18	1H0 906 233	flat contact housing for cable:	9,0X7,8 0,5-1,5	X	
(18)	357 972 742 B	single wiring seal for wire cross section:	9,0X7,8 red 2,5	X	
19	357 972 773	flat contact housing	3 pin	1	
(19)	1H0 973 204	flat contact housing for electric fan:	4 pin 17,18	1	

Model	Year	MG	SG	Illustration	VIN No.	Update	17:23	18.02.20100		ETKA	
PA	90	9	63	188-00		336					

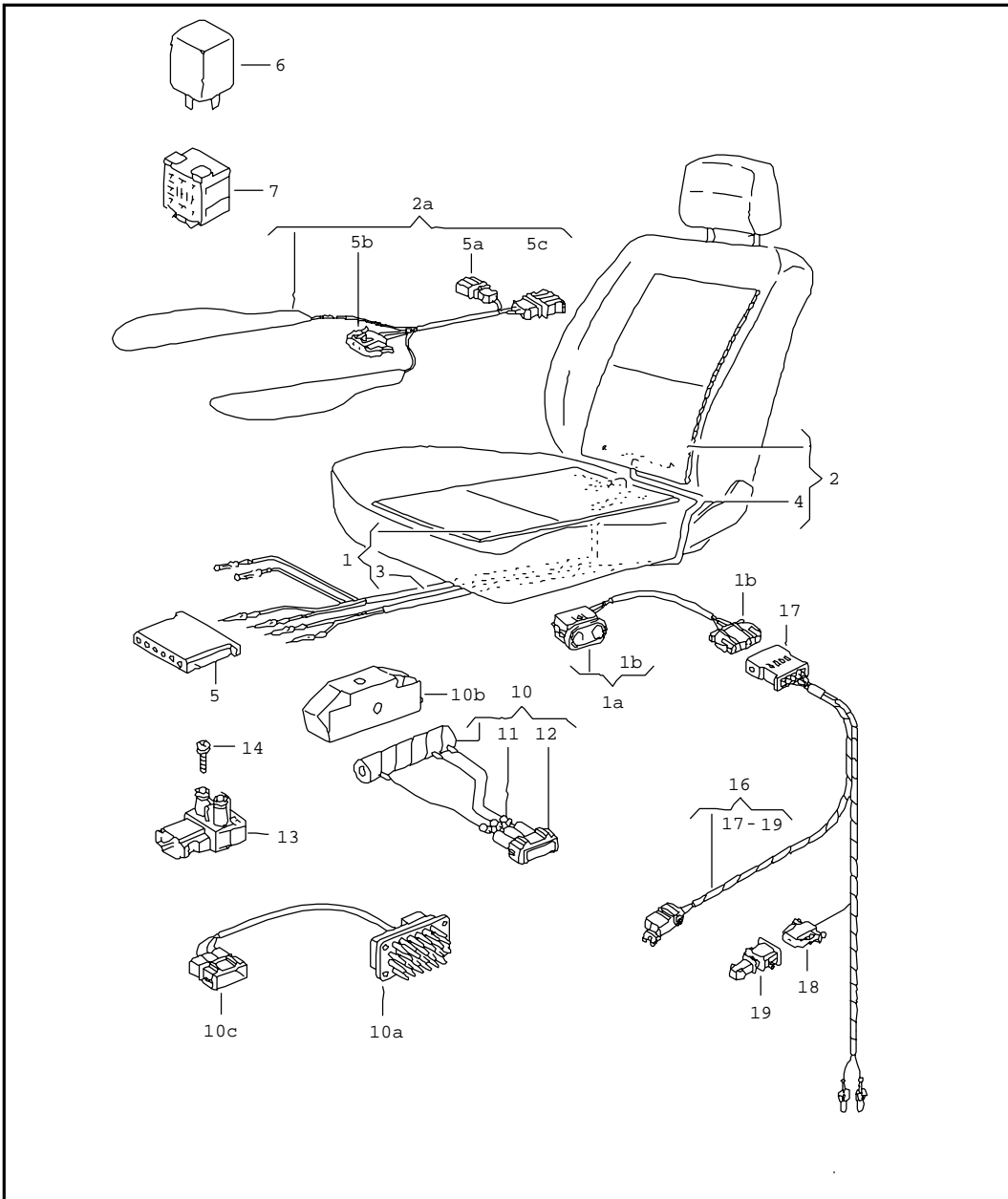

Pos	Part Number	Name	Remarks	Qty	Model
		seat and backrest, heated			
1	161 963 555 A	heater element-seat		2	
(1)	191 963 555	heater element-seat		2	sports version
2	535 963 557	heater element-backrest			
-	N 018 007 4	insulating hose in coils of 5m	W7X0,6	*	
3		shorten to:	670MM	1	
4		shorten to:	970MM	1	
5	171 971 999 E	rd. connector sleeve housing	1,6 6 pin	2	

189

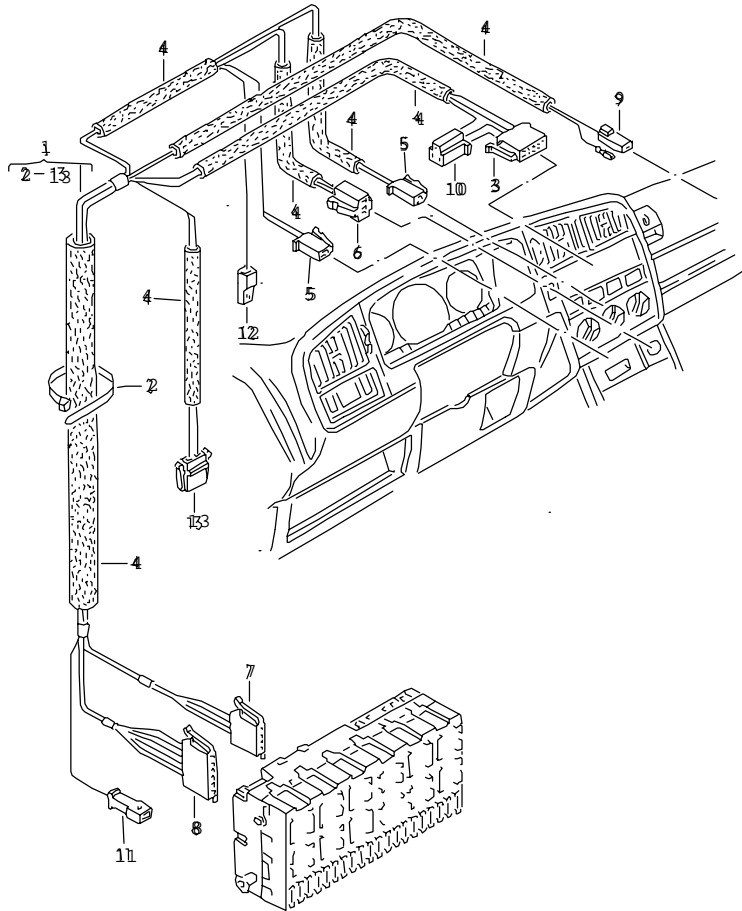



EP 91 1 88 EP 84 5-88



Pos	Part Number	Name	Remarks	Qty	Model
		loom for dashboard			
		connecting piece			
		radio			
		cigarette lighter			
		switch - brake light			

		radio-, loudspeaker- and aerialcomponents			
		see accessories catalog			



		F >> 31-K-400 000			
(1)	357 971 052 D	loom for dashboard		lhd 1	
(1)	357 971 052 E	loom for dashboard		lhd 1	air condit.
1	357 971 052 F	loom for dashboard coupling piece for vehicles with 2 active loudspeakers loudspeaker and/or for vehicles with 6 active loudspeakers		lhd 1	
				4	
(1)	357 971 052 G	loom for dashboard coupling piece for vehicles with 2 active loudspeakers loudspeaker and/or for vehicles with 6 active loudspeakers		lhd 1	air condit.
				4	
(1)	357 971 052 J	loom for dashboard		1	TAXI
(1)	358 971 052 D	loom for dashboard		rhd 1	
(1)	358 971 052 E	loom for dashboard		rhd 1	air condit.

Model	Year	MG	SG	Illustration	VIN No.	Update	17:23	18.02.20100		ETKA	
PA	90	9	71	189-00		336					



Pos	Part Number	Name	Remarks	Qty	Model	Pos	Part Number	Name	Remarks	Qty	Model
(1)	358 971 052 F	loom for dashboard coupling piece for vehicles with 2 active loudspeakers loudspeaker and/or for vehicles with 6 active loudspeakers	rhd	1		(1)	357 971 052 M	loom for dashboard coupling piece for vehicles with 2 active loudspeakers loudspeaker and/or for vehicles with 6 active loudspeakers	lhd	1	
(1)	358 971 052 G	loom for dashboard coupling piece for vehicles with 2 active loudspeakers loudspeaker and/or for vehicles with 6 active loudspeakers	rhd	1	air condit.	(1)	357 971 052 P	loom for dashboard		1	TAXI, hire car
		loom for dashboard connecting piece radio loudspeaker cigarette lighter switch - brake light		4		(1)	358 971 052 H	loom for dashboard	rhd	1	
		----- radio-, loudspeaker- and aerialcomponents see accessories catalog ----- F 31-L-000 001>> 31-L-400 000 for vehicles with air condit. ** see current flow diagram **				(1)	358 971 052 K	loom for dashboard coupling piece for vehicles with 2 active loudspeakers loudspeaker and/or for vehicles with 6 active loudspeakers	rhd	1	
		coupling piece fan cigarette lighter	for:					loom for dashboard connecting piece radio cigarette lighter switch - brake light		4	
								loom for dashboard connecting piece radio cigarette lighter switch - brake light			
								radio-, loudspeaker- and aerialcomponents see accessories catalog ----- F 31-M-000 001>> 31-M-200 000*			
						(1)	357 971 052 R	loom for dashboard for vehicles with air condit. also use: N 903 352 03 191 972 701 ** see current flow diagram ** connecting piece fuse box/relay plate	lhd	1	
									Q	1	

Model	Year	MG	SG	Illustration	VIN No.	Update	17:23	18.02.20100		ETKA	
PA	90	9	71	189-00		336					

Pos	Part Number	Name	Remarks	Qty	Model	Pos	Part Number	Name	Remarks	Qty	Model
(1)	357 971 052 T	loom for dashboard for vehicles with 6 active loudspeakers	lhd	1				single parts			
(1)	357 971 052 AB	loom for dashboard	lhd	1	TAXI, hire car	2	N 020 902 2	cable binder	6X246	1	
(1)	358 971 052 M	loom for dashboard	rhd	1		3	357 035 447	flat contact housing	8 pin black	1	radio
(1)	358 971 052 P	loom for dashboard for vehicles with 6 active loudspeakers	rhd	1		4	533 867 910 A	felt strip (adhesive) 'order unit 25'	20X1X880MM	1	
		loom for dashboard for vehicles with air condit.				5	191 906 231 A	flat contact housing connecting piece ashtray light F >> 31-K-400 000 F 31-M-000 001>> illumination for fresh air controls	2 pin	X	
		also use: N 903 352 03		1		(5)	441 971 989	terminal pin housing connecting piece ashtray light F 31-L-000 001>> 31-L-400 000	2 pin	X	
		191 972 701		1		-	161 937 501	fuse box for flat fuses F 31-M-000 001>>	2 pin		
		** see current flow diagram **				-	N 017 131 9	flat fuse 19/2x5 F 31-M-000 001>>	30-light green AMP	1	
		----- radio-, loudspeaker- and aerialcomponents see accessories catalog ----- F 31-M-200 001>>*				6	191 919 321	flat contact housing connecting piece cigarette lighter	3 pin	1	
(1)	357 971 052 AD	loom for dashboard	lhd	1		(7)	357 907 968 A	flat contact housing connector location: W F >> 31-K-400 000	6 pin	1	
(1)	357 971 052 AF	loom for dashboard for vehicles with 6 active loudspeakers	lhd	1		7	357 919 968 A	flat contact housing with helper contact catch connector location: E	5 pin	1	
(1)	357 971 052 AH	loom for dashboard	lhd	1	TAXI, hire car	8	357 959 968	flat contact housing with helper contact catch connector location: Q	6 pin	1	
(1)	358 971 052 R	loom for dashboard	rhd	1		(8)	357 959 968 B	flat contact housing with helper contact catch connector location: N F 31-M-000 001>>	6 pin	1	
(1)	358 971 052 T	loom for dashboard for vehicles with 6 active loudspeakers	rhd	1		9	111 971 921 B	terminal pin housing connecting piece glove box light	1 pin	1	
		single parts									

Model	Year	MG	SG	Illustration	VIN No.	Update	17:23	18.02.20100		ETKA	
PA	90	9	71	189-00		336					

Pos	Part Number	Name	Remarks	Qty	Model	Pos	Part Number	Name	Remarks	Qty	Model
10	161 971 970	terminal pin housing coupling piece for vehicle with active loudspeakers loom loudspeaker see accessories catalog F >> 31-L-400 000	3 pin	1							
(10)	191 972 703	flat contact housing coupling piece for vehicle with active loudspeakers loom loudspeaker see accessories catalog F 31-M-000 001>>	3 pin	1							
11	161 971 976 A	flat connector housing	1 pin	1	radio						
12	161 971 990 A	terminal pin housing F >> 31-L-400 000	1 pin	1							
(12)	191 972 701	terminal pin housing connecting piece fuse box/relay plate F 31-M-000 001>>	1 pin	1							
(12)	191 972 751	flat contact housing connecting piece fan F 31-M-000 001>>	1 pin								
(12)	191 972 751	flat contact housing connecting piece fan F 31-M-000 001>>	1 pin								
13	191 971 993	flat contact housing connecting piece switch - brake light	2 pin	1							
-	357 971 004	cable holder see illustration:	190	X							
-	357 972 851	cable holder connecting piece cigarette lighter		X							
-	357 972 851 A	cable holder connecting piece air duct glove box light		X							

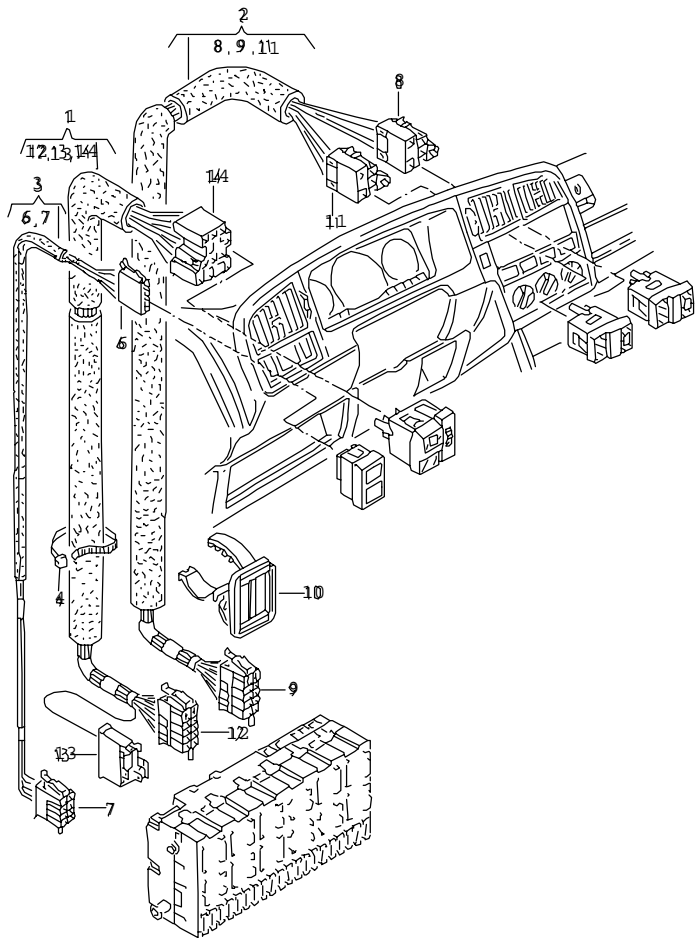

Model	Year	MG	SG	Illustration	VIN No.	Update	17:24	18.02.20100		ETKA	
PA	90	9	71	190-00		336					

190





EP 84 3-88

Pos	Part Number	Name	Remarks	Qty	Model
		loom for side and headlight switch			
		rear window glass			
		for vehicles with fog lamps and rear fog light loom			
		warning lamp			
		for vehicles with anti-locking brake system -abs-			
		for vehicles with trailers			
1	357 971 055	loom for side and headlight switch		1	
(1)	357 971 055 A	loom for side and headlight switch for vehicles with day driving headlights F 31-J-000 001>>	also use: 31-M-000001>> 191 972 701 ** see current flow diagram ** N 903 352 03	1	
(1)	357 971 055 B	loom for side and headlight switch for vehicles with dim-dip driving lights	also use: 31-M-000001>> 191 972 701 ** see current flow diagram ** N 903 352 03	1	
(1)	357 971 055 F	loom for side and headlight switch	also use: 31-M-000001>> 191 972 701 ** see current flow diagram ** N 903 352 03	1	TAXI
(1)	357 971 055 P	loom for side and headlight switch for vehicles with day driving headlights	also use: 31-M-000001>> 191 972 701 ** see current flow diagram ** N 903 352 03	1	TAXI, hire car



Model	Year	MG	SG	Illustration	VIN No.	Update	17:24	18.02.20100		ETKA	
PA	90	9	71	190-00		336					

Pos	Part Number	Name	Remarks	Qty	Model	Pos	Part Number	Name	Remarks	Qty	Model
(2)	191 971 056	wiring loom for heated rear window and fog lights switch		1		(13)	191 972 701	terminal pin housing for vehicles with day driving headlights for vehicles with dim-dip driving lights F 31-M-000 001>>	1 pin	1	
		also use:	N 904 219 02	1							
(3)	--- --- --- .	discontinued / replacement: single parts loom warning lamp		1		(14)	357 971 999 B	flat contact housing for vehicles with dim-dip driving lights	11 pin	1	
(4)	N 020 902 2	cable binder	6X246	X		14	357 971 999 C	flat contact housing	11 pin	1	
(6)	191 906 231 A	flat contact housing for vehicles with trailers	2 pin	X		(14)	357 971 999 D	flat contact housing for vehicles with day driving headlights	11 pin	1	
6	191 906 231 D	flat contact housing for vehicles with anti-locking brake system -abs-	5 pin	X							
7	357 919 968 B	flat contact housing with helper contact catch connector location:	8 pin X	1							
(7)	357 919 968 B	flat contact housing with helper contact catch connecting piece loom warning lamp	8 pin	X							
8	357 941 599	flat contact housing for vehicles with fog lamps and rear fog light	5 pin	1							
9	357 959 968 A	flat contact housing with helper contact catch connector location:	10 pin P	1							
10	357 971 004	cable holder		X							
11	357 971 837	flat contact housing	5 pin	1							
12	357 971 968 C	flat contact housing with helper contact catch connector location:	10 pin R	1							
13	357 971 975	terminal pin housing	1 pin	1							
(13)	161 971 990 A	terminal pin housing for vehicles with day driving headlights for vehicles with dim-dip driving lights F >> 31-L-400 000 F >> 31-L-400 000	1 pin	2 1	TAXI						

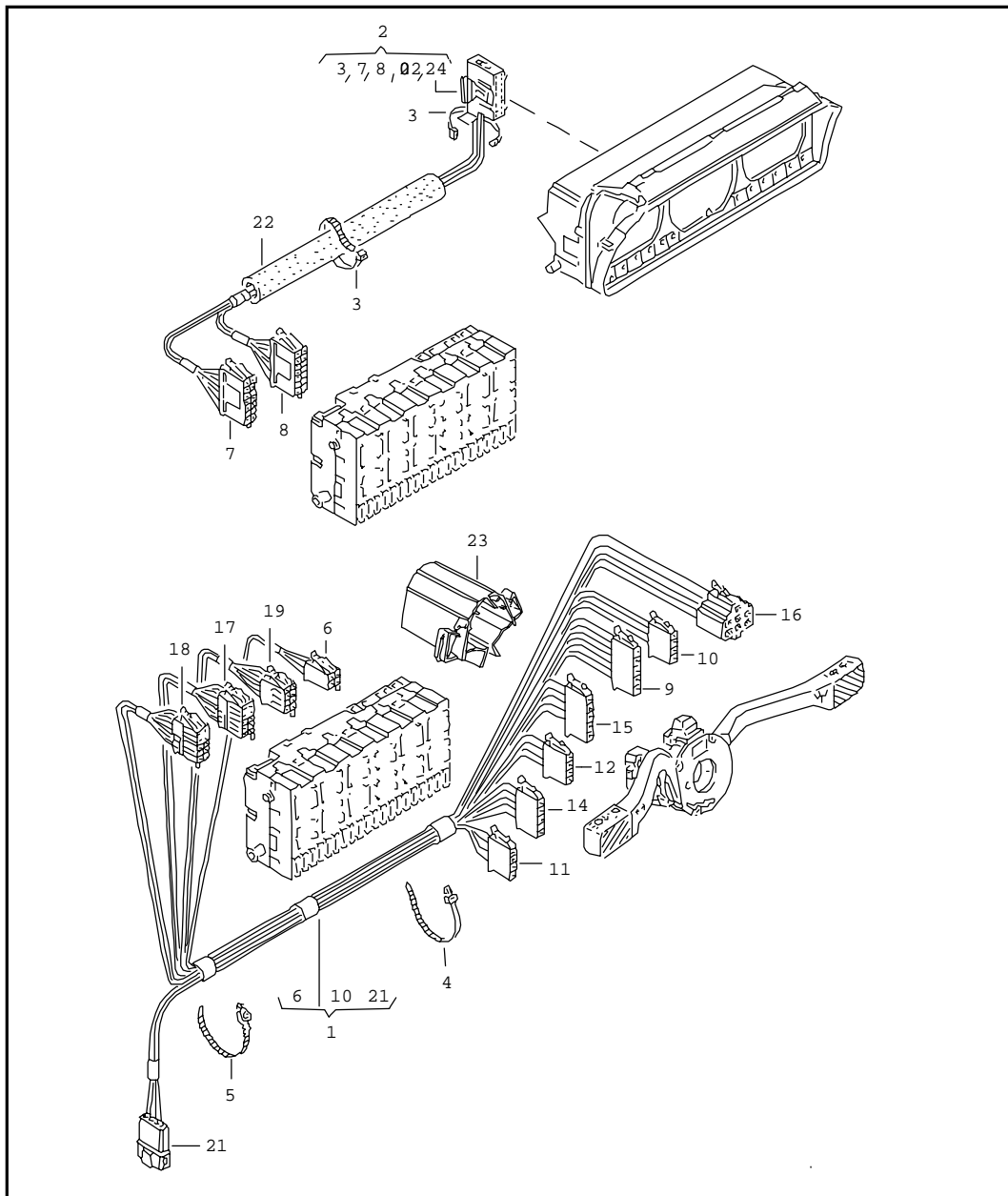
Model	Year	MG	SG	Illustration	VIN No.	Update	17:25	18.02.20100		ETKA	
PA	90	9	71	191-00		336					





Pos	Part Number	Name	Remarks	Qty	Model
		wiring loom for steering col. combinat. switch F >> 31-L-400 000			
(1)	357 971 063 S	wiring loom for steering col. combinat. switch		1	
(1)	357 971 063 E	wiring loom for steering col. combinat. switch for vehicles with passive restraint system	ELRA	1	
(1)	357 971 063 G	wiring loom for steering col. combinat. switch		1	TAXI
(1)	357 971 063 BQ	wiring loom for steering col. combinat. switch F 31-M-000 001>>		1	
(1)	357 971 063 BS	wiring loom for steering col. combinat. switch		1	TAXI
(1)	357 971 063 BQ	wiring loom for steering col. combinat. switch for vehicles with day driving headlights		1	
(1)	357 971 063 CJ	wiring loom for steering col. combinat. switch for vehicles with day driving headlights for vehicles with multi function indicator		1	
(1)	357 971 063 CJ	wiring loom for steering col. combinat. switch for vehicles with day driving headlights		1	TAXI
(2)	358 971 064 F	wiring loom for instrument housing F >> 31-L-400 000		1	

Model	Year	MG	SG	Illustration	VIN No.	Update	17:25	18.02.20100		ETKA	
PA	90	9	71	191-00		336					

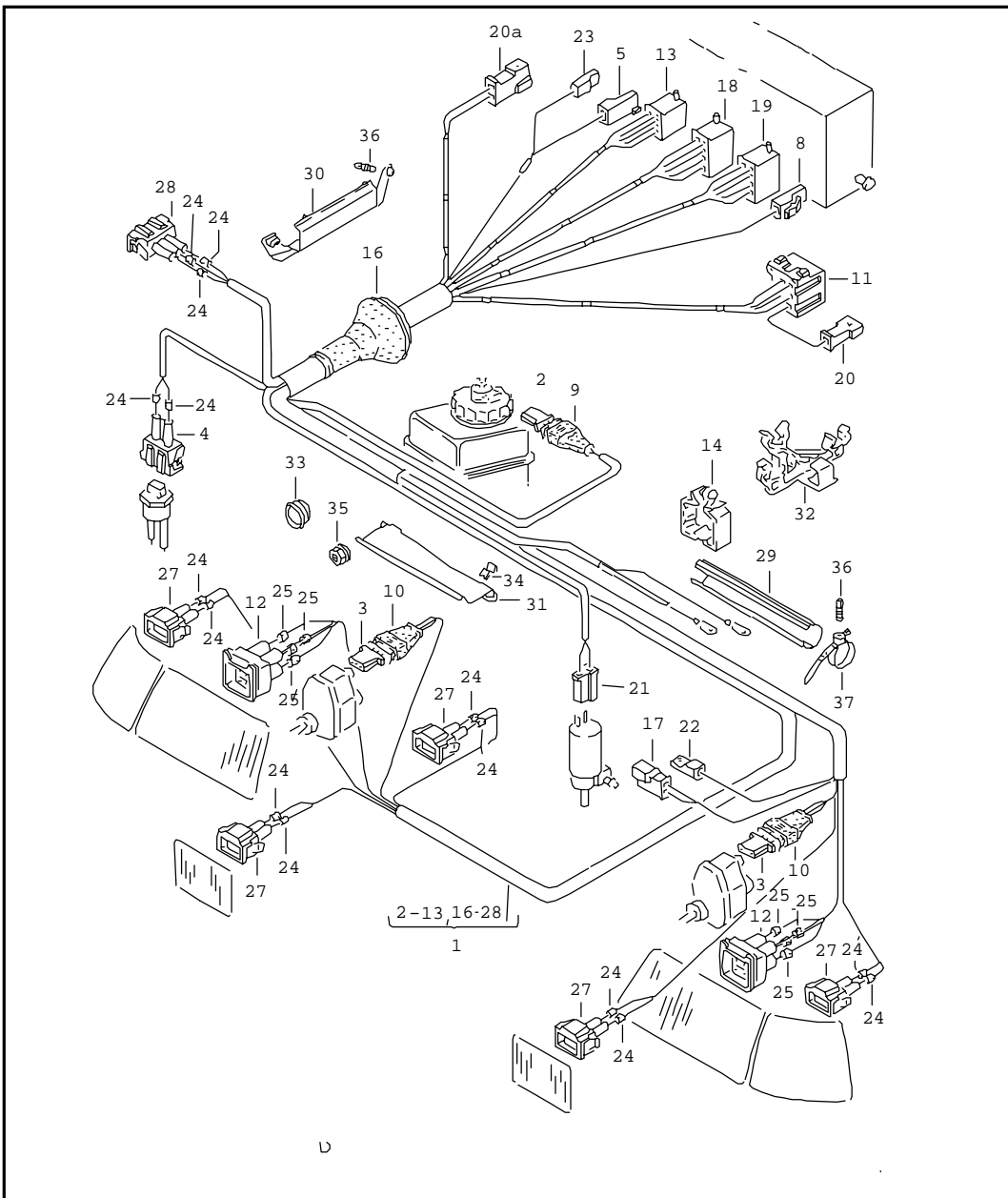

Pos	Part Number	Name	Remarks	Qty	Model	Pos	Part Number	Name	Remarks	Qty	Model
(2)	358 971 064 A	wiring loom for instrument housing		1	1Y,RA,SB	(6)	191 972 701	terminal pin housing connecting piece for vehicles with passive restraint system	1 pin ELRA	1	
(2)	358 971 064 D	wiring loom for instrument housing		1	"J.."	(6)	161 971 989 C	terminal pin housing F >> 31-L-400 000	2 pin	1	TAXI
		wiring loom for instrument housing F 31-ME000 001>> 31-ME264 356* F 31-MB000 001>>				(6)	191 972 702	flat contact housing F 31-M-000 001>>	2 pin	1	TAXI
(2)	357 971 064 N	wiring loom for instrument housing		1	"J.."	7	357 919 971 D	flat contact housing connector location: U1	14 pin	1	
(2)	358 971 064 K	wiring loom for instrument housing		1		8	357 919 971 C	flat contact housing connector location: U2	14 pin	1	
(2)	358 971 064 H	wiring loom for instrument housing		1	diesel eng.	(8)	191 972 701	terminal pin housing connecting piece loom, left, front loom, right, front F 31-M-000 001>>	1 pin	2	
		wiring loom for instrument housing F 31-ME264 357>>*				(8)	191 972 702	flat contact housing connecting piece automatic F 31-M-000 001>>	2 pin	1	
(2)	357 971 064 T	wiring loom for instrument housing		1	"J.."	(9)	1H0 953 633	flat contact housing connecting piece steering col. combi switch	7 pin	1	
(2)	358 971 064 Q	wiring loom for instrument housing		1		(10)	1H0 953 633 A	flat contact housing connecting piece steering col. combi switch	4 pin	1	
(2)	358 971 064 N	wiring loom for instrument housing		1	diesel eng.	(11)	1H0 953 634	flat contact housing connecting piece steering col. combi switch for vehicles with cruise control system	4 pin	1	
(2)	358 971 064 N	wiring loom for instrument housing		1	diesel eng.	(12)	1H0 953 634 A	flat contact housing connecting piece steering col. combi switch for vehicles with multi function indicator	4 pin	1	
		single parts =====				(14)	1H0 953 635	flat contact housing connecting piece steering col. combi switch	5 pin	1	
(3)	N 020 902 2	cable binder	6X246	X		(15)	1H0 953 637	flat contact housing connecting piece steering col. combi switch	5 pin	1	
4	N 900 603 01	cable binder	6,5X175	X							
5	N 904 288 01	cable binder with bracket for welded pin:	10X185 5	X							
6	357 907 968	terminal pin housing for vehicles with multi function indicator connector location:	4 pin V	1							



Pos	Part Number	Name	Remarks	Qty	Model
		loom, left, front F >> 31-K-400 000			1F,1Y,9A,EZ, PB,PF,KR,RA, RF,RP
(1)	357 971 071 E	loom, left, front	lhd	1	EZ,RF,KR,PB, PF,9A
(1)	357 971 071 L	loom, left, front	lhd	1	RA,RP,1F,1Y
(1)	358 971 071 D	loom, left, front	rhd	1	EZ,RF,KR,PB, PF,9A
(1)	358 971 071 K	loom, left, front	rhd	1	RA,RP,1F,1Y
		loom, left, front F 31-L-000 001>> 31-L-400 000			EZ,PB,PF,KR, RP,SB,1F,1Y, 2E,9A
(1)	357 971 071 AR	loom, left, front	lhd	1	RP,SB,1F,1Y
(1)	357 971 071 BG	loom, left, front	lhd	1	EZ,KR,PB,PF, 2E,9A
(1)	358 971 071 AN	loom, left, front	rhd	1	RP,SB,1F,1Y
(1)	358 971 071 BD	loom, left, front	rhd	1	EZ,KR,PB,PF, 2E,9A
		loom, left, front F 31-M-000 001>>			AAA,AAM,EZ, KR,RP,2E,9A, diesel eng.
(1)	357 971 071 DN	loom, left, front ** see current flow diagram ** also use:	lhd	1	EZ,AAM,RP
					161 971 989 C X 357 906 232 X
(1)	357 971 071 DC	loom, left, front for vehicles with day driving headlights also use:	lhd	1	AAM,RP
					161 971 989 C 1
		connecting piece water pump			
(1)	357 971 071 EA	loom, left, front ** see current flow diagram ** also use:	lhd	1	AAA,KR,2E,9A diesel eng.
					357 906 232 X 161 971 989 C X

Model	Year	MG	SG	Illustration	VIN No.	Update	17:25	18.02.20100		ETKA	
PA	90	9	71	192-00		336					



Pos	Part Number	Name	Remarks	Qty	Model	Pos	Part Number	Name	Remarks	Qty	Model
(1)	358 971 071 CS	loom, left, front for vehicles with day driving headlights	rhd	1	AAM,RP	2	443 906 231	terminal pin housing	2 pin	1	
		connecting piece water pump	also use: 161 971 989 C	1		3	311 906 231 B	terminal pin housing connecting piece for vehicles with headlight range adjustment F >> 31-L-400 000	3 pin	2	
(1)	358 971 071 DJ	loom, left, front	rhd	1	"GB.":EZ,AAM RP	(3)	357 972 753	flat contact housing connecting piece for vehicles with headlight range adjustment	3 pin	6	
		connecting piece electric fan ** see current flow diagram **	also use: 357 906 232	1	"GB.":AAM,RP			F 31-M-000 001>> also use: 357 972 742 A	2	2	
		connecting piece water pump	also use: 161 971 989 C	1		4	357 906 752	flat contact housing	2 pin	1	
(1)	358 971 071 DP	loom, left, front	rhd	1	AAA,9A,, "GB.": KR,2E,9A, diesel eng.	5	357 915 971 A	terminal pin housing connector location: Z2	1 pin	1	
		connecting piece electric fan ** see current flow diagram **	also use: 357 906 232	1	"GB.": diesel eng.: AAZ,SB,1Y	8	357 915 971 B	terminal pin housing connector location: 30,30B	1 pin	1	
		connecting piece water pump	also use: 161 971 989 C	1		9	447 919 141	protective cap terminal pin housing	2 pin	1	
(1)	358 971 071 DQ	loom, left, front for vehicles with day driving headlights	rhd	1	AAA,KR,2E,9A	10	281 919 141 A	protective cap terminal pin housing F >> 31-L-400 000	3 pin	2	
		connecting piece water pump	also use: 161 971 989 C	1		(10)	357 972 742 A	single wiring seal for wire cross section: F 31-M-000 001>>	9,0X7,8 white 1,5	6	
(1)	358 971 071 DF	loom, left, front for vehicles with day driving headlights	rhd	1	diesel eng.	11	161 937 501 B	relay plate connecting piece relay electric fan ELEKTROLUEFTERNACHLAUF	9 pin	X	
		connecting piece water pump	also use: 161 971 989 C	1		12	357 941 165	flat contact housing	4 pin	2	
		single parts				13	357 955 968	flat contact housing with helper contact catch connector location: C	8 pin	1	
						14	867 971 848	clip	6,5	X	
						(16)	357 971 905 E	grommet	46/16	1	
						(16)	111 971 907	grommet connecting piece wiper motor F >> 31-L-400 000	24/8,5	1	rhd

Model	Year	MG	SG	Illustration	VIN No.	Update	17:25	18.02.20100		ETKA	
PA	90	9	71	192-00		336					

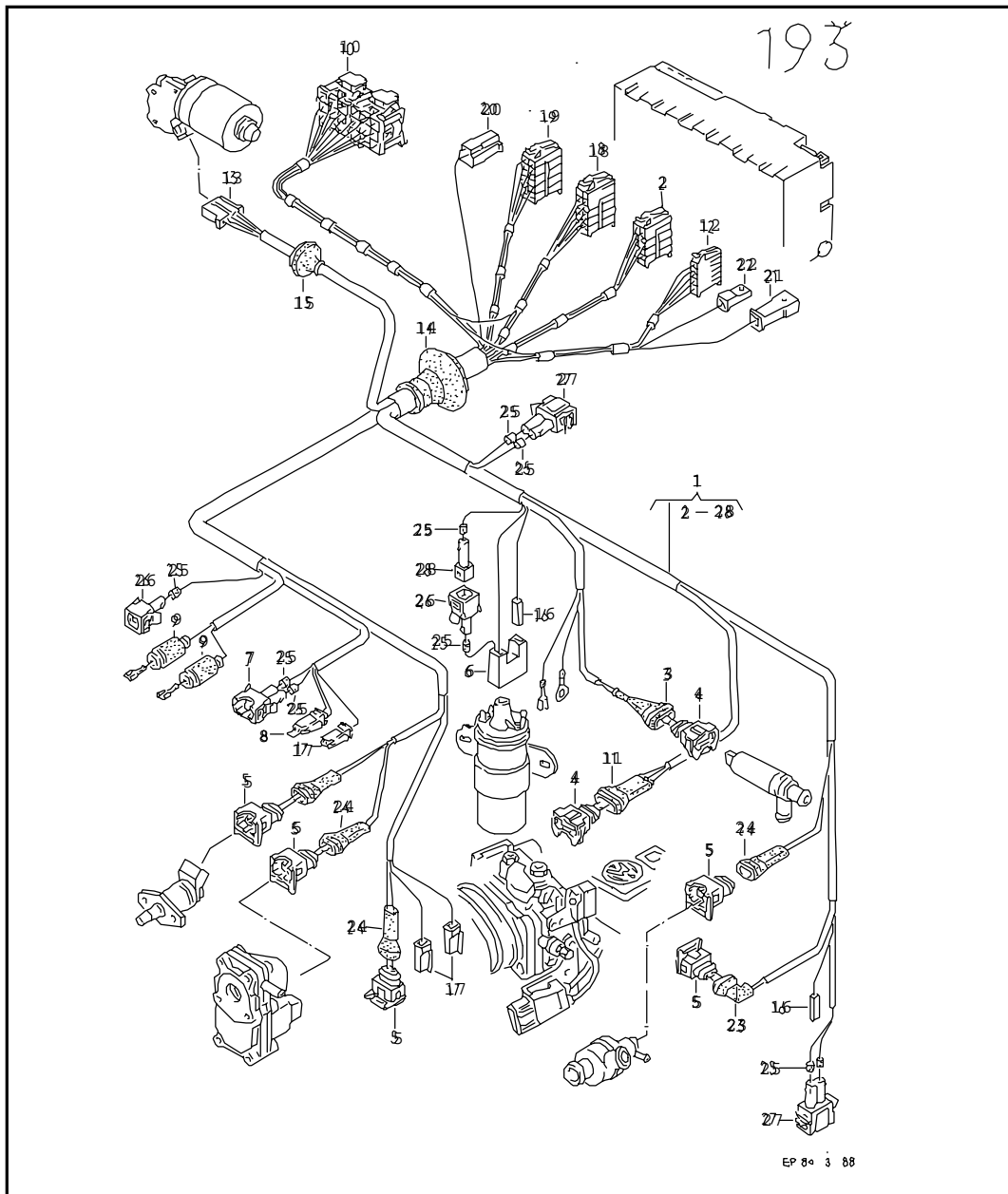

Pos	Part Number	Name	Remarks	Qty	Model	Pos	Part Number	Name	Remarks	Qty	Model
(16)	357 971 913 A	grommet connecting piece wiper motor F 31-M-000 001>>	27,5/5 rhd	1		28	357 972 753	flat contact housing connecting piece turn signal	3 pin side	1	
17	171 971 934	terminal pin housing coupling piece electric fan F >> 31-K-400 000	2 pin	X		(28)	171 971 835 A	terminal pin housing connecting piece wiper motor	5 pin rhd	1	
(17)	357 906 232	flat contact housing coupling piece electric fan F 31-L-000 001>>	2 pin	1	RP,SB,1F,1Y	29	357 971 461	heat insulating connecting piece rip plate on front cross panel		1	
(17)	1H0 906 233	flat contact housing coupling piece electric fan F 31-L-000 001>>	3 pin	1	EZ,KR,PB,PF, 2E,9A	30	357 971 615	cover connecting piece suspension strut mounting	right	1	
18	357 971 968	flat contact housing with helper contact catch connector location:	8 pin A2	1		31	357 971 615 A	wiring conduit connecting piece water box rip plate on front cross panel		1	2E,9A,AAA, KR,RP
19	357 971 968 A	flat contact housing with helper contact catch connector location:	8 pin A1	1		32	357 971 898	bracket connecting piece side member	3 point	1	
20	161 971 976 A	flat connector housing	1 pin	1		33	357 971 908 B	plug connecting piece rip plate on front cross panel water box	50/54	1	1Y,SB
20A	161 971 988 C	flat connector housing	2 pin	1		34	357 972 793 F	clamp		2	
21	161 971 989 C	terminal pin housing connecting piece water pump	2 pin	1		(35)	171 201 969	shouldered hex. nut		2	
22	161 971 990 A	terminal pin housing F >> 31-K-400 000	1 pin	X		36	N 901 757 01	welded pin	5X12	3	
23	431 971 995	terminal pin housing	1 pin	1		37	N 904 449 01	cable binder	5X230	1	
24	357 972 741 A	single wiring seal for wire cross section:	5,6X7,8 red 1,5	X							
25	357 972 742 A	single wiring seal for wire cross section:	9,0X7,8 white 1,5	X							
(25)	357 972 742 B	single wiring seal for wire cross section:	9,0X7,8 red 2,5	X							
27	357 972 752	flat contact housing	2 pin	X							



Pos	Part Number	Name	Remarks	Qty	Model
		loom, right, front F >> 31-L-400 000			KR
1	357 971 072 C	loom, right, front F >> 31-K-400 000	lhd	1	
(1)	357 971 072 BL	loom, right, front F 31-L-000 001>>	lhd	1	
(1)	358 971 072 E	loom, right, front F >> 31-K-400 000	rhd	1	
(1)	358 971 072 BG	loom, right, front F 31-L-000 001>>	rhd	1	
		loom, right, front F 31-M-000 001>>			KR
(1)	357 971 072 GA	loom, right, front	lhd	1	
		single parts			
2	357 903 968	flat contact housing with helper contact catch connector location: F	10 pin	1	
(3)	443 906 102 B	grommet	18X20,5	1	
(4)	443 906 233	flat contact housing connecting piece control valve for idling stabilization throttle valve positioner warm-up valve	3 pin LFR	X 1 1	
(5)	443 906 232	flat contact housing connecting piece deceleration cut-off valve cold starting valve thermo time switch pressure warning switch	2 pin	X 1 1 1 1	
(5)	443 906 232	flat contact housing connecting piece deceleration cut-off valve cold starting valve thermo time switch pressure warning switch	2 pin	X 1 1 1 1	
6	171 906 231 B	terminal pin housing	2 pin	1	



Model	Year	MG	SG	Illustration	VIN No.	Update	17:25	18.02.20100		ETKA	
PA	90	9	71	193-00		336					

Pos	Part Number	Name	Remarks	Qty	Model	Pos	Part Number	Name	Remarks	Qty	Model
7	037 906 240	flat contact housing connecting piece multi function indicator	2 pin	1		27	357 972 752	flat contact housing connecting piece wiring harness for transistorized ignition system	2 pin	1	
8	191 911 920	terminal pin housing	1 pin	X		28	357 972 761	flat contact housing	1 pin	1	
9	191 919 083	protective cap connecting piece oil pressure switch	32X10 0,3/1,8	2		-	357 971 615	cover connecting piece suspension strut mounting	right	1	
10	443 937 528	relay plate connecting piece relay control valve for idling stabilization	9 pin	2		-	535 971 848 A	clip connecting piece cooling pipe	20	1	
(11)	191 906 102	protective cap		X		-	027 971 501 A	bracket connecting piece cylinder head ground strap	rear	1	
12	357 955 968 A	flat contact housing with helper contact catch connector location:	5 pin S	1							
13	171 971 835 A	terminal pin housing	5 pin	1							
(14)	357 971 905 E	grommet	46/16	1							
15	111 971 907	grommet	24/8,5	1							
16	111 971 921 B	terminal pin housing	1 pin	2							
17	191 971 922	terminal pin housing	1 pin	3							
18	357 971 967	flat contact housing with helper contact catch connector location:	12 pin G1	1							
19	357 971 967 A	flat contact housing with helper contact catch connector location:	12 pin G2	1							
20	161 971 975	flat connector housing	3 pin	1							
21	161 971 976 A	flat connector housing	1 pin	1							
22	161 971 990 A	terminal pin housing	1 pin	1							
23	443 972 525	grommet		X							
24	810 972 525	grommet	12,5X31	X							
25	357 972 741 A	single wiring seal for wire cross section:	5,6X7,8 red 1,5	X							
26	357 972 751	flat contact housing	1 pin	1							

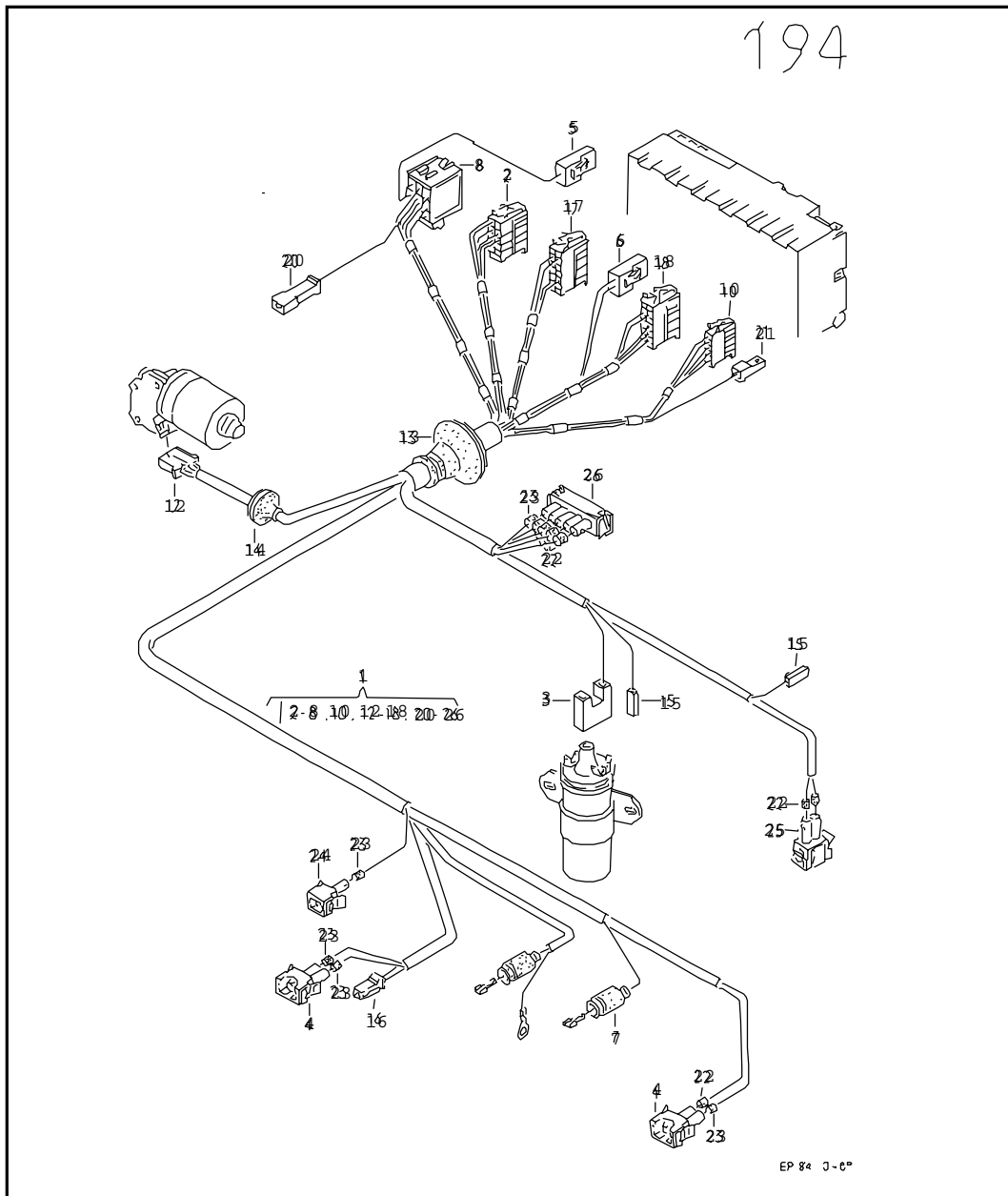

Model	Year	MG	SG	Illustration	VIN No.	Update	17:26	18.02.20100		ETKA	
PA	90	9	71	194-00		336					



Pos	Part Number	Name	Remarks	Qty	Model
		loom, right, front resistance cable F >> 31-K-400 000			RP 1F,1Y,9A,EZ, PB,PF,RA,FR,
-	357 971 060	resistance cable connecting piece throttle valve positioner		1	RP
(1)	357 971 072 E	loom, right, front	lhd	1	1Y,RA
(1)	357 971 072 AA	loom, right, front	lhd	1	automatic: 1Y,RA
(1)	357 971 072 D	loom, right, front	lhd	1	EZ,RF
(1)	357 971 072 T	loom, right, front	lhd	1	automatic: EZ,RF
(1)	357 971 072 K	loom, right, front	lhd	1	PB,PF
(1)	357 971 072 AH	loom, right, front	lhd	1	automatic: PB,PF
(1)	357 971 072 Q	loom, right, front for vehicles without catalyst	ECE lhd	1	RP
(1)	357 971 072 R	loom, right, front for vehicles without catalyst	ECE lhd	1	automatic: RP
(1)	357 971 072 H	loom, right, front for vehicles with catalyst	lhd	1	1F,RP
(1)	357 971 072 J	loom, right, front for vehicles with catalyst	lhd	1	automatic: 1F,RP
(1)	357 971 072 M	loom, right, front	lhd	1	9A
(1)	357 971 072 AK	loom, right, front	lhd	1	automatic: 9A
(1)	358 971 072 A	loom, right, front	rhd	1	1Y,RA
(1)	358 971 072 A	loom, right, front	rhd	1	1Y,RA
(1)	358 971 072 AA	loom, right, front	rhd	1	automatic: 1Y,RA
(1)	358 971 072	loom, right, front	rhd	1	EZ,RF
(1)	358 971 072 T	loom, right, front	rhd	1	automatic: EZ,RF

Model	Year	MG	SG	Illustration	VIN No.	Update	17:26	18.02.20100		ETKA	
PA	90	9	71	194-00		336					



Pos	Part Number	Name	Remarks	Qty	Model	Pos	Part Number	Name	Remarks	Qty	Model
(1)	358 971 072 K	loom, right, front	rhd	1	PB,PF	(1)	357 971 072 AK	loom, right, front	lhd	1	automatic: 9A
(1)	358 971 072 AH	loom, right, front	rhd	1	automatic: PB,PF	(1)	358 971 072 CA	loom, right, front	rhd	1	EZ
(1)	358 971 072 Q	loom, right, front for vehicles without catalyst	rhd	1	RP	(1)	358 971 072 DB	loom, right, front	rhd	1	1Y,SB
(1)	358 971 072 R	loom, right, front for vehicles without catalyst	rhd	1	automatic: RP	(1)	358 971 072 BL	loom, right, front	rhd	1	RP
(1)	358 971 072 H	loom, right, front for vehicles with catalyst	rhd	1	1F,RP	(1)	358 971 072 BE	loom, right, front for vehicles with regulated catalyst	rhd	1	1F,RP
(1)	358 971 072 J	loom, right, front for vehicles with catalyst	rhd	1	automatic: 1F,RP	(1)	358 971 072 BJ	loom, right, front	rhd	1	PB,PF
(1)	358 971 072 M	loom, right, front	rhd	1	9A	(1)	358 971 072 BP	loom, right, front	rhd	1	automatic: PB,PF
(1)	358 971 072 AK	loom, right, front	rhd	1	automatic: 9A	(1)	358 971 072 BK	loom, right, front	rhd	1	9A
		loom, right, front resistance cable F 31-L-000 001>> 31-L-400 000			RP 1F,1Y,9A,EZ, PB,PF,RA,RF, RP,SB			single parts			
-	357 971 060	resistance cable connecting piece throttle valve positioner		1	RP	2	357 903 968	flat contact housing with helper contact catch connector location: F	10 pin	1	
-	357 971 060	resistance cable connecting piece throttle valve positioner		1	RP	3	171 906 231 B	terminal pin housing	2 pin	1	
(1)	357 971 072 D	loom, right, front	lhd	1	EZ	4	037 906 240	flat contact housing connecting piece switches on transmission temperature sensor	2 pin	X	
(1)	357 971 072 BQ	loom, right, front	lhd	1	1F,RP	5	357 915 971 B	terminal pin housing connector location: 30	1 pin	1	
(1)	357 971 072 BM	loom, right, front for vehicles with multi function indicator	lhd	1	1F,RP	6	357 915 971 C	terminal pin housing connector location: Z1	1 pin	1	
(1)	357 971 072 FR	loom, right, front	lhd	1	1Y,SB,RA	7	191 919 083	protective cap connecting piece oil pressure switch	32X10 0,3/1,8	2	
(1)	357 971 072 BN	loom, right, front	lhd	1	PB,PF	8	161 937 501 B	relay plate connecting piece relay	9 pin	X	
(1)	357 971 072 BT	loom, right, front	lhd	1	automatic: PB,PF						
(1)	357 971 072 BP	loom, right, front	lhd	1	9A						

Model	Year	MG	SG	Illustration	VIN No.	Update	17:26	18.02.20100		ETKA	
PA	90	9	71	194-00		336					

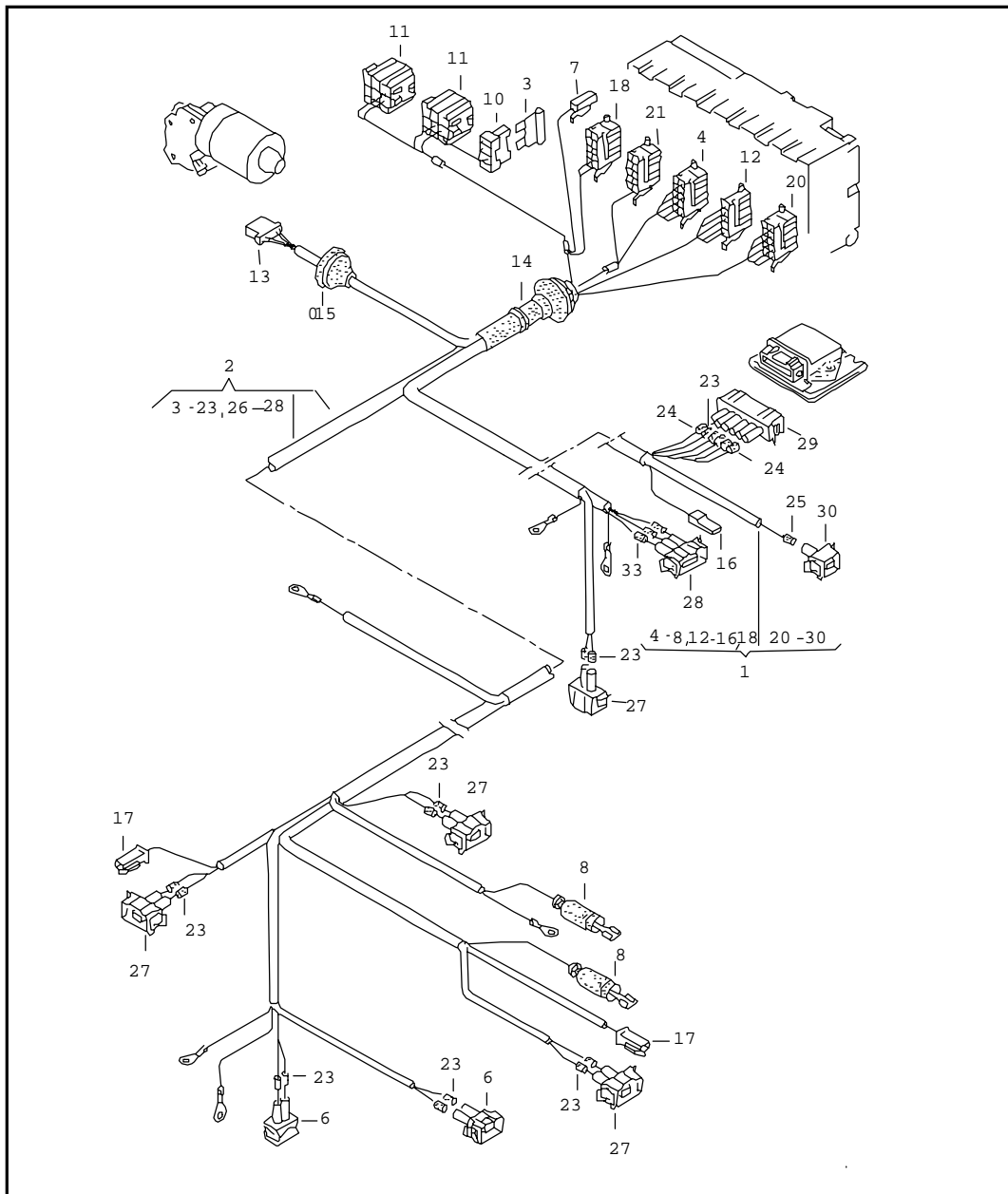

Pos	Part Number	Name	Remarks	Qty	Model	Pos	Part Number	Name	Remarks	Qty	Model
10	357 955 968 A	flat contact housing with helper contact catch connector location:	5 pin S	1		-	027 971 501 A	bracket connecting piece cylinder head ground strap	rear	1	
12	171 971 835 A	terminal pin housing	5 pin	1		-	357 971 615	cover connecting piece suspension strut mounting	right	1	
(13)	357 971 905 E	grommet	46/16	1		-	535 971 848 A	clip connecting piece cooling pipe	20	1	
14	111 971 907	grommet	24/8,5	1							
15	111 971 921 B	terminal pin housing connecting piece temperature regulator switch ignition coil	1 pin	X 1 1							
16	191 971 922	terminal pin housing connecting piece clip	1 pin 50	X							
17	357 971 967	flat contact housing with helper contact catch connector location:	12 pin G1	1							
18	357 971 967 A	flat contact housing with helper contact catch connector location:	12 pin G2	1							
20	161 971 976 A	flat connector housing	1 pin	1							
21	161 971 990 A	terminal pin housing	1 pin	1							
22	357 972 741	single wiring seal for wire cross section:	5,6X7,8 blue 1,0	X							
23	357 972 741 A	single wiring seal for wire cross section:	5,6X7,8 red 1,5	X							
24	357 972 751	flat contact housing	1 pin	1							
25	357 972 752	flat contact housing connecting piece pressure warning switch	2 pin	1							
26	357 972 755	flat contact housing connecting piece wiring harness for transistorized ignition system	5 pin	1							
(26)	357 972 756	flat contact housing connecting piece wiring harness for transistorized ignition system	6 pin	1							



Pos	Part Number	Name	Remarks	Qty	Model
		loom, right, front F 31-M-000 001>>			EZ, diesel eng.: AAZ,SB,1Y
1	357 971 072 FE	loom, right, front	lhd	1	EZ
(1)	358 971 072 FE	loom, right, front	rhd	1	EZ
(2)	357 971 072 GL	loom, right, front	lhd	1	diesel eng.: AAZ
(2)	357 971 072 FR	loom, right, front	lhd	1	diesel eng.: 1Y,SB
(2)	358 971 072 GL	loom, right, front	rhd	1	diesel eng.: AAZ
(2)	358 971 072 CC	loom, right, front	rhd	1	diesel eng./ automatic: AAZ
(2)	358 971 072 DB	loom, right, front	rhd	1	diesel eng.: SB,1Y
3	N 017 131 5	flat fuse	19/2x5 10-red		diesel eng.: SB
4	357 903 968	flat contact housing with helper contact catch	10 pin	1	
(4)	443 906 236	flat contact housing connecting piece distributor	3 pin	1	
-	191 906 102	protective cap		1	EZ
6	037 906 240	flat contact housing connecting piece	2 pin	X	
		thermo switch		1	EZ
		automatic chock			
		thermo switch		1	EZ
		pre-heater			
		temperature sender		1	diesel eng.: 1Y,SB
		valve		1	diesel eng.: 1Y,SB

Model	Year	MG	SG	Illustration	VIN No.	Update	17:26	18.02.20100		ETKA	
PA	90	9	71	194-01		336					



Pos	Part Number	Name	Remarks	Qty	Model	Pos	Part Number	Name	Remarks	Qty	Model
		switch - altitude corrector		1	diesel eng.: 1Y,SB	16	111 971 921 B	terminal pin housing	1 pin	1	
		switch		1	diesel eng.: 1Y,SB	17	191 971 922	terminal pin housing	1 pin	1	diesel eng.: SB,1Y
		temperature gauge		1	EZ, diesel eng.: 1Y,SB	18	357 971 967	flat contact housing with helper contact catch connector location: G1	12 pin	1	
7	357 907 971 B	terminal pin housing connector location:	1 pin U2,Y	1	EZ, diesel eng.: SB	20	357 971 967 A	flat contact housing with helper contact catch connector location: G2	12 pin	1	
(7)	357 915 971 C	terminal pin housing connector location:	1 pin Z1	1	EZ	21	357 971 968 B	flat contact housing with helper contact catch connector location: D	12 pin	1	
(7)	191 972 752	flat contact housing	2 pin	X	diesel eng./ automatic: AAZ,1Y	(21)	161 971 990 A	terminal pin housing connecting piece fuse box/relay plate	1 pin	1	EZ
8	191 919 083	protective cap	32X10	2		(21)	191 972 701	terminal pin housing coupling piece	1 pin 191 971 711	1	EZ
(10)	357 919 754	flat contact housing connecting piece temperature gauge	4 pin	1	diesel eng.: AAZ	(21)	191 972 711	flat connector housing coupling piece	1 pin 191 972 701	1	EZ
		also use:	357 972 741 A	X		(21)	191 972 705	terminal pin housing	5 pin	1	diesel eng./ automatic: AAZ,1Y
10	161 937 501	fuse box for flat fuses	2 pin	1	diesel eng.: SB	23	357 972 741 A	single wiring seal for wire cross section:	5,6X7,8 red 1,5	X	
11	161 937 501 B	relay plate for contact:	9 pin	X	diesel eng.: 1Y 2 diesel eng.: SB	24	357 972 741 B	single wiring seal for wire cross section:	5,6X7,8 yellow orange 2,5	2	EZ
(11)	867 937 501	relay plate	9 pin		diesel eng.: AAZ	25	357 972 742 B	single wiring seal for wire cross section:	9,0X7,8 red 2,5	2	EZ
(11)	281 937 505 A	fuse box without fuses		1	diesel eng.: AAZ	(27)	357 972 751	flat contact housing connecting piece clip solenoid valve	1 pin 61	1	EZ AAZ
12	357 955 968 A	flat contact housing with helper contact catch connector location:	5 pin S	1		27	357 972 752	flat contact housing	2 pin	X	
13	171 971 835 A	terminal pin housing	5 pin	1		28	357 972 753	flat contact housing	3 pin	1	
(14)	357 971 905 E	grommet	46/16	1		29	357 972 756	flat contact housing connecting piece temperature sensor	6 pin	1	EZ
15	147 971 913	grommet									

Model	Year	MG	SG	Illustration	VIN No.	Update	17:26	18.02.20100		ETKA	
PA	90	9	71	194-01		336					

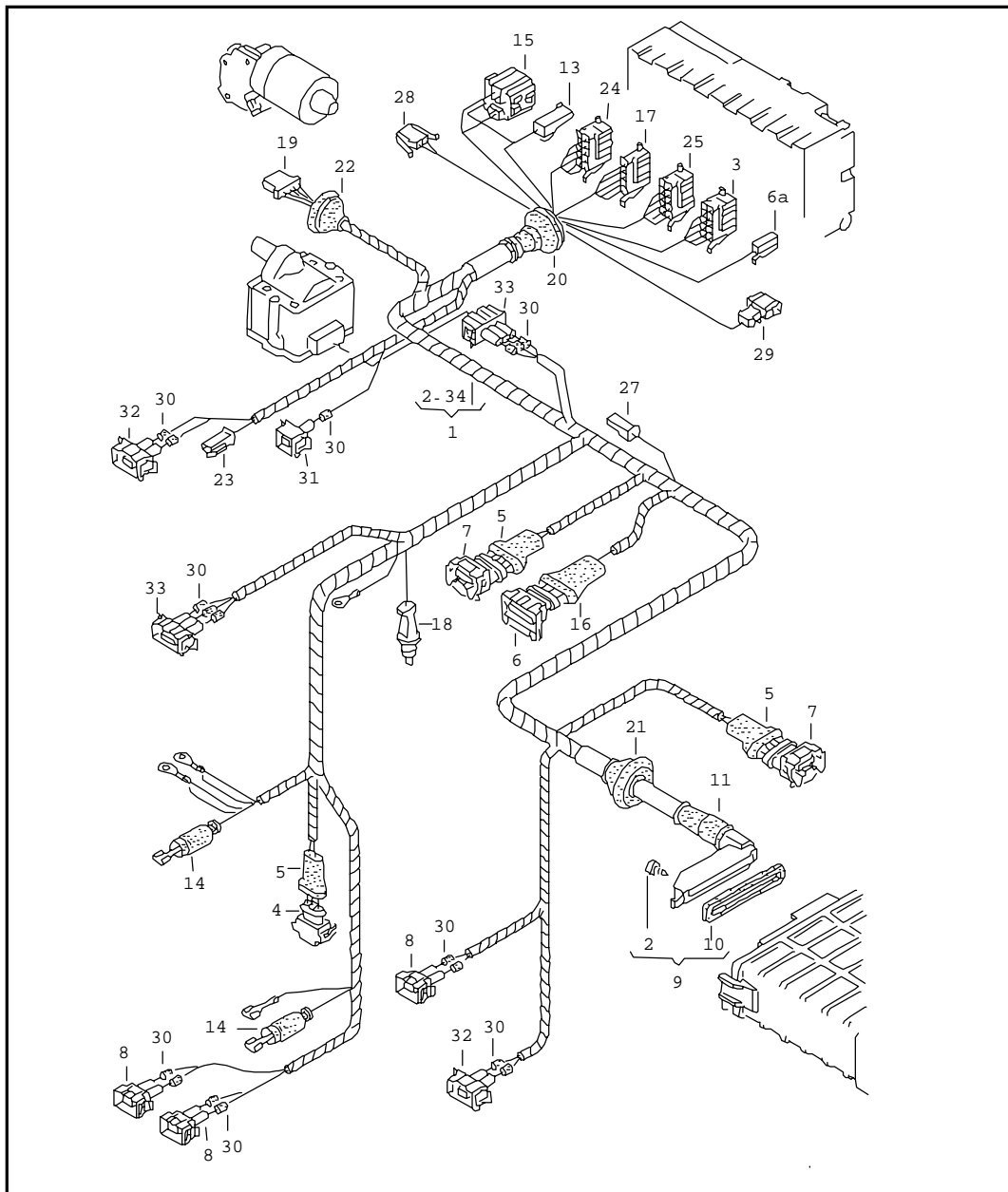

Pos	Part Number	Name	Remarks	Qty	Model	Pos	Part Number	Name	Remarks	Qty	Model
30	357 972 771	flat contact housing connecting piece pre-heater	1 pin	1	EZ						



Pos	Part Number	Name	Remarks	Qty	Model
		loom, right, front F 31-M-000 001>>			AAM,RP
1	357 971 072 DR	loom, right, front for vehicles with catalyst	lhd	1	AAM,RP
(1)	357 971 072 EB	loom, right, front for vehicles with catalyst	lhd	1	automatic: RP
(1)	357 971 072 EH	loom, right, front for vehicles without catalyst	ECE lhd	1	RP
(1)	357 971 072 EM	loom, right, front for vehicles without catalyst	ECE lhd	1	automatic: RP
(1)	358 971 072 DR	loom, right, front for vehicles with regulated catalyst	rhd	1	RP
(1)	358 971 072 EB	loom, right, front for vehicles with regulated catalyst	rhd	1	automatic: RP
(1)	358 971 072 EF	loom, right, front for vehicles without catalyst	rhd	1	RP
(1)	358 971 072 EM	loom, right, front for vehicles without catalyst	rhd	1	automatic: RP
2	N 013 953 2	tapping screw, fill. hd.	B2,9X9,5	1	
3	357 903 968	flat contact housing with helper contact catch connector location:	10 pin F	1	
(4)	443 906 236	flat contact housing connecting piece distributor	3 pin	1	
(5)	893 945 521	protective cap	28X10,7	1	
6	025 906 235 B	flat contact housing connecting piece sender for throttle position	5 pin	1	
(6)	071 906 233	flat contact housing connecting piece sender for throttle position	7 pin	1	automatic
6A	701 906 231	flat contact housing	1 pin	1	

Model	Year	MG	SG	Illustration	VIN No.	Update	17:36	18.02.20100		ETKA	
PA	90	9	71	194-02		336					



Pos	Part Number	Name	Remarks	Qty	Model	Pos	Part Number	Name	Remarks	Qty	Model
(7)	4A0 906 234	flat contact housing connecting piece injector throttle valve positioner	4 pin	X		23	191 971 922	terminal pin housing connecting piece starter	1 pin	1	
				1							
				1							
8	037 906 240	flat contact housing connecting piece temperature gauge valve	2 pin NTC	X		24	357 971 967	flat contact housing with helper contact catch connector location: G1	12 pin	1	
				1							
				1							
(9)	3A0 906 370	flat contact housing with gasket connecting piece electronic control unit	35 pin	1		25	357 971 967 A	flat contact housing with helper contact catch connector location: G2	12 pin	X	
						(25)	161 971 970	terminal pin housing connecting piece automatic	3 pin	1	
10	191 906 375	gasket flat contact housing	16X110,5 35 pin	1		27	161 971 990 A	terminal pin housing connecting piece intake manifold pre-heater	1 pin	1	
11	357 906 376	protective cap	27X20	1							
13	357 915 971 B	terminal pin housing connector location:	1 pin 30	1		28	191 972 702	flat contact housing coupling piece for diagnosis plug	2 pin	1	
14	191 919 083	protective cap connecting piece oil pressure switch	32X10 0,3/1,8	2		28	191 972 702	flat contact housing coupling piece for diagnosis plug	2 pin	1	
15	867 937 501	relay plate connecting piece relay pre-heater	9 pin	1		(28)	191 972 724	flat contact housing	8 pin	1	automatic
16	893 945 521	protective cap	28X10,7	1		29	191 972 712	flat connector housing	2 pin	1	
16	893 945 521	protective cap	28X10,7	1		30	357 972 741 A	single wiring seal for wire cross section:	5,6X7,8 red 1,5	X	
(16)	037 906 102 A	protective cap terminal pin housing	7 pin	1	automatic	31	357 972 751	flat contact housing connecting piece clip	1 pin 61	1	
17	357 955 968 A	flat contact housing with helper contact catch connector location: S	5 pin	1		32	357 972 752	flat contact housing connecting piece air condit. outer temperature gauge switches on transmission	2 pin MFA	X 1 1	
18	323 971 108 C	loom for lambda probe		1							
19	171 971 835 A	terminal pin housing connecting piece wiper motor	5 pin	1		33	357 972 753	flat contact housing connecting piece transformer distance sensor	3 pin	X 1 1	
20	357 971 905 E	grommet	46/16	1							
(21)	357 971 905 A	grommet	52X16	1		(33)	357 972 754 J	flat contact housing connecting piece lambda probe for vehicles with catalyst	4 pin	1	
(22)	357 971 913 A	grommet	27,5/5	1							

Model	Year	MG	SG	Illustration	VIN No.	Update					ETKA	
PA	90	9	71	194-02		336	17:36	18.02.20100				

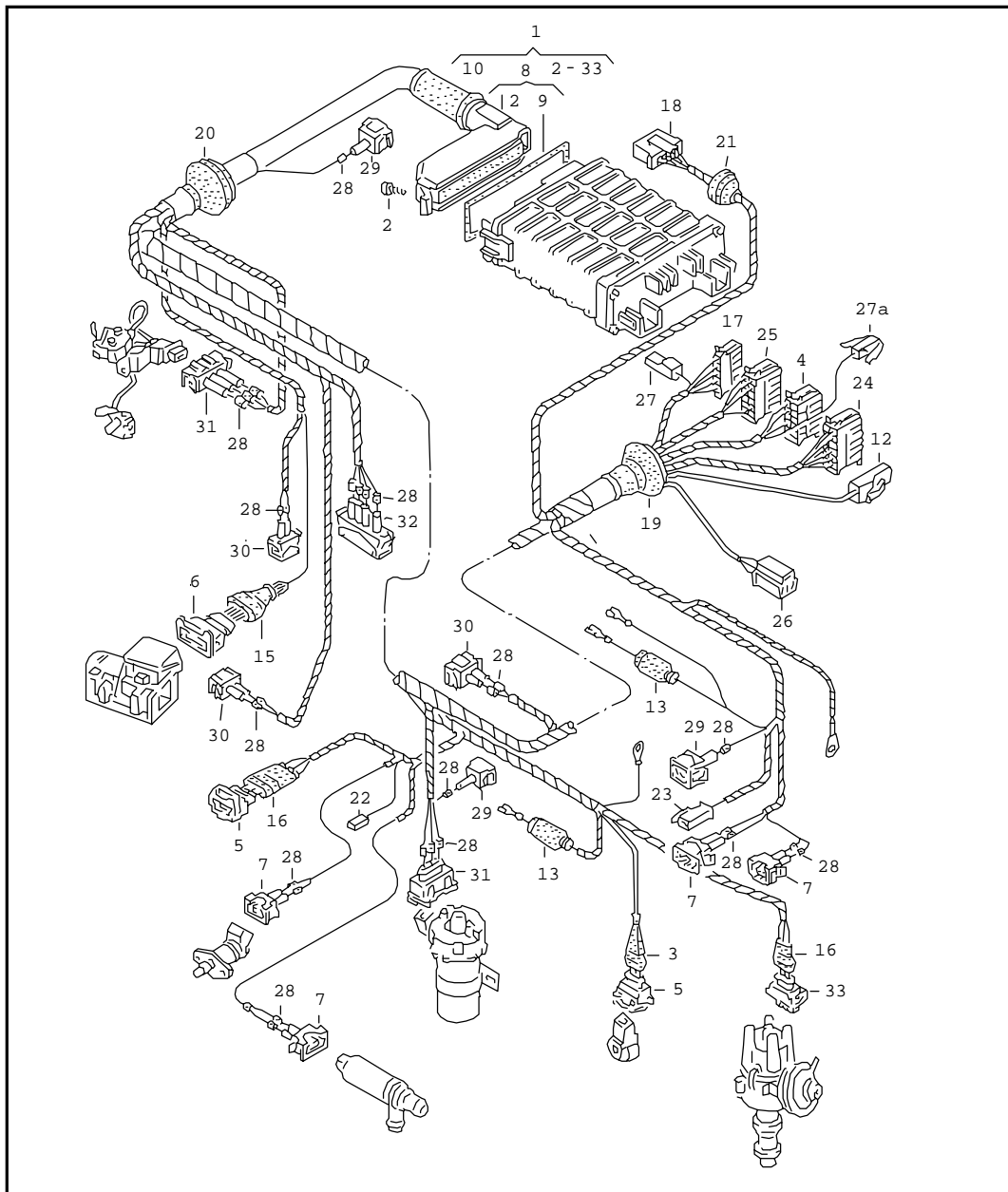

Pos	Part Number	Name	Remarks	Qty	Model	Pos	Part Number	Name	Remarks	Qty	Model
34	--- --- ---	no longer available									





Pos	Part Number	Name	Remarks	Qty	Model
		loom, right, front F >> 31-L-400 000			2E
(1)	357 971 072 CG	loom, right, front	lhd	1	
(1)	357 971 072 CN	loom, right, front and/or for vehicles with catalyst for vehicles with on-board computer	lhd	1	
1	357 971 072 CP	loom, right, front and/or for vehicles with catalyst for vehicles with on-board computer	lhd	1	automatic
		loom, right, front F 31-M-000 001>>			2E
(1)	357 971 072 JT	loom, right, front	lhd	1	
		connecting piece temperature sensor	also use: N 903 352 03 037 906 240 357 972 741 A	4 2 4	
		connecting piece starter	also use: N 017 494 7 191 971 922	1 1	
(1)	357 971 072 HH	loom, right, front	lhd	1	automatic
(1)	358 971 072 HG	loom, right, front	rhd	1	
(1)	358 971 072 HH	loom, right, front	rhd	1	automatic
		single parts			
2	N 013 953 2	tapping screw, fill. hd.	B2,9X9,5	1	
(3)	443 906 102 B	grommet	18X20,5	1	
4	357 903 968	flat contact housing with helper contact catch connector location: F	10 pin	1	
5	443 906 233	flat contact housing connecting piece potentiometer control valve for idling stabilization anti-knock sensor	3 pin CO	X 1 1 1	

Model	Year	MG	SG	Illustration	VIN No.	Update	17:37	18.02.20100		ETKA	
PA	90	9	71	194-05		336					

Pos	Part Number	Name	Remarks	Qty	Model	Pos	Part Number	Name	Remarks	Qty	Model
6	025 906 235 B	flat contact housing connecting piece air flow meter	5 pin	1		22	111 971 921 B	terminal pin housing connecting piece temperature regulator switch	1 pin	1	
7	037 906 240	flat contact housing connecting piece temperature sensor temperature sender cold starting valve	2 pin NTC	X 1 1 1		23	191 971 922	terminal pin housing connecting piece clip starter	1 pin 50	X 1 1	
(8)	701 906 365	flat contact housing with gasket connecting piece electronic control unit	38 pin	1		24	357 971 967	flat contact housing with helper contact catch connector location: G1	12 pin	1	
9	191 906 375	gasket flat contact housing	16X110,5 38 pin	1		25	357 971 967 A	flat contact housing with helper contact catch connector location: G2	12 pin	1	
10	357 906 376	protective cap F >> 31-M-300 000*	27X20	1		26	161 971 970	terminal pin housing F >> 31-L-400 000	3 pin	1	automatic
(10)	357 906 376 E	protective cap F 31-M-300 001>>*	52/24/32	1		(26)	191 972 705	terminal pin housing F 31-M-000 001>>	5 pin	1	automatic
12	357 915 971 C	terminal pin housing connector location:	1 pin Z1	1		(26)	191 972 752	flat contact housing F 31-M-000 001>>	2 pin	1	automatic
13	191 919 083	protective cap	32X10	2		(26)	191 972 712	flat connector housing F 31-M-000 001>>	2 pin	1	air condit.
15	893 945 521	protective cap	28X10,7	1		27	161 971 990 A	terminal pin housing	1 pin	1	
(16)	191 906 102	protective cap		X		27A	191 972 701	terminal pin housing	1 pin	1	
17	357 955 968 A	flat contact housing with helper contact catch connector location:	5 pin S	1		28	357 972 741 A	single wiring seal for wire cross section:	5,6X7,8 red 1,5	X	
18	171 971 835 A	terminal pin housing connecting piece wiper motor	5 pin	X		29	357 972 751	flat contact housing	1 pin	2	
(19)	357 971 905 E	grommet	46/16	1		30	357 972 752	flat contact housing coupling piece automatic connecting piece outer temperature gauge injector switches on transmission	2 pin MFA	X 1 1 1	
20	357 971 905 A	grommet F >> 31-M-300 000*	52/16	1		31	357 972 753	flat contact housing connecting piece potentiometer ignition coil F 31-L-000 001>> distance sensor F 31-M-000 001>>	3 pin	X	
(20)	357 906 376 E	protective cap F 31-M-300 001>>*	52/24/32	1							
21	111 971 907	grommet F >> 31-L-400 000	24/8,5	1							
(21)	357 971 913 A	grommet F 31-M-000 001>>	27,5/5	1							



Model	Year	MG	SG	Illustration	VIN No.	Update	17:37	18.02.20100		ETKA	
PA	90	9	71	194-05		336					

Pos	Part Number	Name	Remarks	Qty	Model	Pos	Part Number	Name	Remarks	Qty	Model
32	357 972 754 J	flat contact housing connecting piece lambda probe	4 pin	1							
(33)	443 906 236	flat contact housing	3 pin	1							

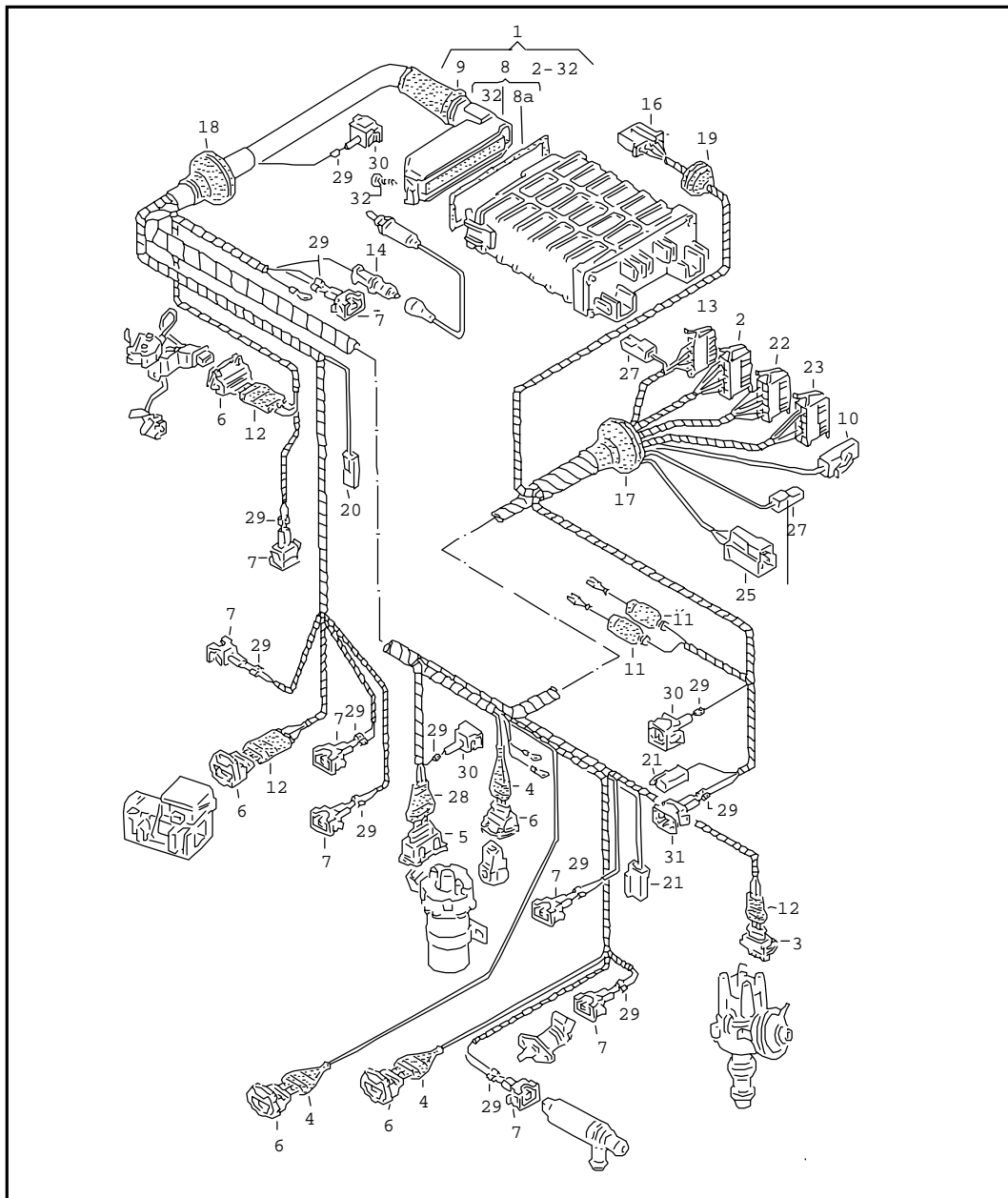

Model	Year	MG	SG	Illustration	VIN No.	Update	17:37	18.02.20100		ETKA	
PA	90	9	71	194-10		336					



Pos	Part Number	Name	Remarks	Qty	Model
		loom, right, front F >> 31-L-400 000 connecting piece lambda probe	2 pin		"J.."
(1)	358 971 072 CF	loom, right, front		1	automatic
		loom, right, front F 31-M-000 001>>			9A,"J.."
(1)	357 971 072 FK	loom, right, front F >> 31-M-175 680*	lhd	1	
(1)	357 971 072 KH	loom, right, front connecting piece anti-knock sensor potentiometer contact	gold plated lhd	1	
		F 31-M-175 681>>*			
(1)	357 971 072 FL	loom, right, front F >> 31-M-175 680*	lhd	1	automatic
(1)	357 971 072 GH	loom, right, front connecting piece anti-knock sensor potentiometer contact	gold plated lhd	1	automatic
		F 31-M-175 681>>*			
(1)	358 971 072 FF	loom, right, front F >> 31-M-080 000*	rhd	1	
(1)	358 971 072 KD	loom, right, front connecting piece anti-knock sensor potentiometer contact	gold plated rhd	1	
		F 31-M-080 001>>*			
(1)	358 971 072 FG	loom, right, front F >> 31-M-080 000*	rhd	1	automatic
(1)	358 971 072 FR	loom, right, front connecting piece anti-knock sensor potentiometer contact	gold plated rhd	1	automatic
		F 31-M-080 001>>*			
		single parts			

Model	Year	MG	SG	Illustration	VIN No.	Update	17:37	18.02.20100		ETKA	
PA	90	9	71	194-10		336					



Pos	Part Number	Name	Remarks	Qty	Model	Pos	Part Number	Name	Remarks	Qty	Model
2	357 903 968	flat contact housing with helper contact catch connector location: F	10 pin	1		(7)	357 972 754 J	flat contact housing connecting piece lambda probe F 31-M-000 001>>	4 pin 357 972 764 K	1	
(3)	443 906 236	flat contact housing	3 pin	1		(7)	357 972 764 K	flat connector housing connecting piece F 31-M-000 001>>	4 pin 357 972 754 J	1	
(3)	357 972 753	flat contact housing connecting piece distance sensor F 31-M-000 001>>	3 pin	1		(8)	3A0 906 370	flat contact housing with gasket	35 pin	1	
4	443 906 102 B	grommet	18X20,5	2		8A	191 906 375	gasket flat contact housing	16X110,5 35 pin	1	
5	191 906 232 B	terminal pin housing connecting piece ignition coil	3 pin	1		9	357 906 376	protective cap	27X20	1	
6	443 906 233	flat contact housing connecting piece switch throttle valve air flow meter anti-knock sensor cylinder	3 pin	X X 1 2 1		10	357 915 971 B	terminal pin housing connector location:	1 pin 30,30B	1	
(6)	443 906 232	flat contact housing connecting piece switch throttle valve also use:	2 pin	X		11	191 919 083	protective cap	32X10	2	
7	037 906 240	flat contact housing connecting piece switch throttle valve temperature sender cut-off valve throttle valve positioner valve cold starting valve idling stabilisation lambda probe F >> 31-L-400 000	2 pin	X 1 1 1 1 1 1 1 1 1		12	191 906 102	protective cap		X	
			191 906 102	X		13	357 955 968 A	flat contact housing with helper contact catch connector location: S	5 pin	1	
				X		14	323 971 108 C	loom for lambda probe F >> 31-L-400 000		1	
				X		16	171 971 835 A	terminal pin housing connecting piece wiper motor	5 pin	1	
				1		(17)	357 971 905 E	grommet	46/16	1	
				1		(18)	357 971 905 A	grommet	52X16	1	
				1		19	111 971 907	grommet	24/8,5	1	
			white	1		20	111 971 921 B	terminal pin housing connecting piece thermo switch	1 pin	1	
				1		21	191 971 922	terminal pin housing connecting piece clip temperature sender	1 pin 50	X 1 1	
			LFR	1		22	357 971 967	flat contact housing with helper contact catch connector location: G1	12 pin	1	

Model	Year	MG	SG	Illustration	VIN No.	Update	17:37	18.02.20100		ETKA	
PA	90	9	71	194-10		336					

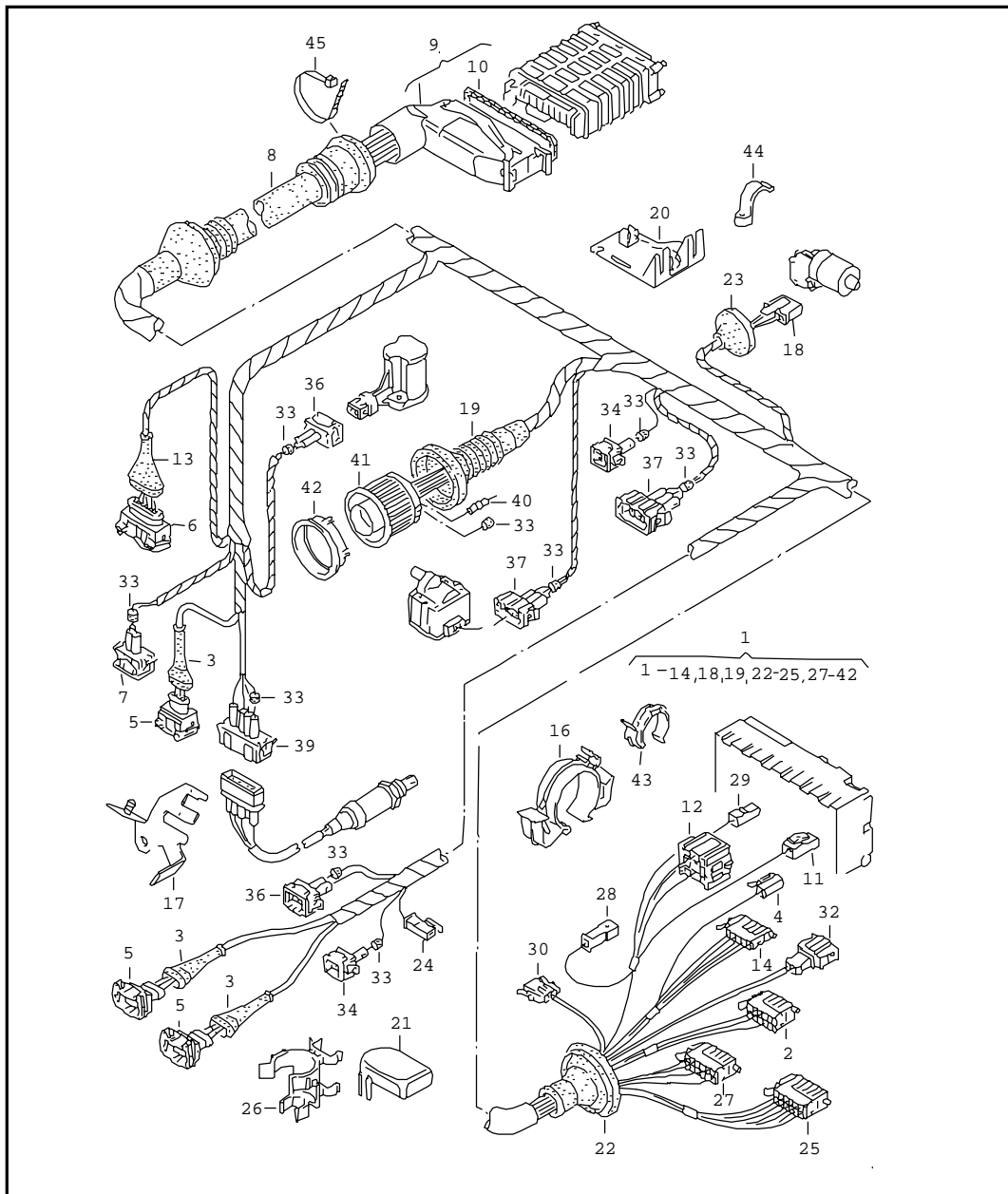
Pos	Part Number	Name	Remarks	Qty	Model	Pos	Part Number	Name	Remarks	Qty	Model
23	357 971 967 A	flat contact housing with helper contact catch connector location:	12 pin G2	1							
(23)	161 971 970	terminal pin housing coupling piece	3 pin	1	automatic						
25	161 971 975	flat connector housing connecting piece for diagnosis plug	3 pin	1							
27	161 971 990 A	terminal pin housing connecting piece thermo switch for fan run-on	1 pin	2							
(28)	191 927 907	protective cap	16X25	1							
29	357 972 741 A	single wiring seal for wire cross section:	5,6X7,8 red 1,5	X							
30	357 972 751	flat contact housing	1 pin	1							
31	357 972 752	flat contact housing connecting piece outer temperature gauge switches on transmission coupling piece F >> 31-L-400 000	2 pin MFA	X 1 1 1	automatic						
(31)	191 972 705	terminal pin housing coupling piece F 31-M-000 001>>	5 pin	1	automatic						
32	N 013 953 2	tapping screw, fill. hd.	B2,9X9,5	1							





Pos	Part Number	Name	Remarks	Qty	Model
		loom for engine compartment connecting piece electronic control unit			AAA
1	357 971 072 EC	loom for engine compartment	lhd	1	
2	357 903 968	flat contact housing with helper contact catch connector location: F	10 pin	1	
3	443 906 102 B	grommet	18X20,5	3	
4	701 906 231	flat contact housing	1 pin	1	
5	443 906 233	flat contact housing connecting piece	3 pin	X	
		anti-knock sensor		2	
		speed sender		1	
6	022 906 233 A	terminal pin housing	6 pin	1	
7	037 906 240	flat contact housing	2 pin	1	
8	357 906 376 B	protective cap	52/24/39	1	
9	357 907 495 A	flat contact housing with gasket connecting piece electronic control unit	55 POLIG MOTRONIC	1	
10	357 907 498 A	gasket flat contact housing	19X110 55 POLIG	1	
11	357 915 971 B	terminal pin housing connector location:	1 pin 30,30B	1	
12	161 937 501 B	relay plate connecting piece relay pump	9 pin	1	
13	853 945 521	grommet		1	
14	357 955 968 A	flat contact housing with helper contact catch connector location: S	5 pin	1	
16	535 971 359	cable holder		1	
17	357 971 501 A	bracket connecting piece lambda probe anti-knock sensor		2	

Model	Year	MG	SG	Illustration	VIN No.	Update	17:40	18.02.20100		ETKA	
PA	90	9	71	194-20		336					

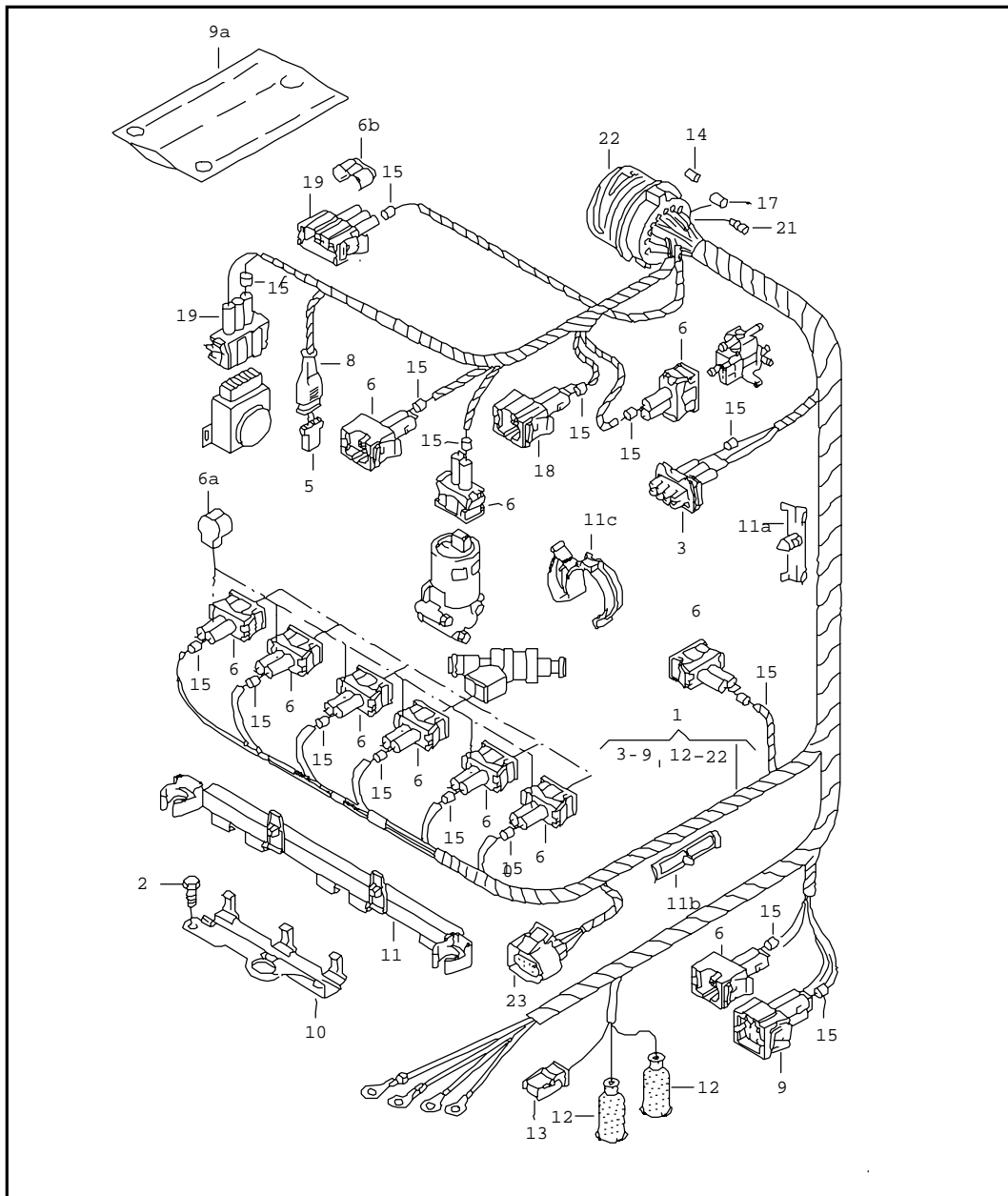

Pos	Part Number	Name	Remarks	Qty	Model	Pos	Part Number	Name	Remarks	Qty	Model
18	171 971 835 A	terminal pin housing connecting piece wiper motor	5 pin	1		36	357 972 752	flat contact housing connecting piece temperature sensor switches on transmission	2 pin	X	
19		discontinued part								1	
(20)	357 971 899 G	bracket connecting piece flat contact housing	28 pin	1		37	357 972 753	flat contact housing connecting piece transformer	3 pin	1	
21	701 971 899 J	cap connecting piece bracket	701 971 899 K	1		39	357 972 754 J	flat contact housing connecting piece lambda probe	4 pin	1	
22	357 971 905 E	grommet	46/16	1		40	357 972 840	plug	4,0X7,8	3	
(23)	357 971 913 A	grommet	27,5/5	1		41	1H0 973 103	flat contact housing with gasket coupling piece wiring loom for engine valve	28 pin	1	
24	191 971 922	terminal pin housing connecting piece starter	1 pin	1		42	--- --- ---	no longer available			
25	357 971 967	flat contact housing with helper contact catch connector location:	12 pin G1	1		43	021 971 848	cable holder connecting piece cooling pipe	34.8	1	
26	701 971 899 K	bracket		1		44	357 971 898 D	bracket	lhd	1	
27	357 971 967 A	flat contact housing with helper contact catch connector location:	12 pin G2	1		(44)	358 971 898	bracket	rhd	1	
28	161 971 976 A	flat connector housing	1 pin	1		(45)	N 020 902 2	cable binder	6X246	1	
29	161 971 990 A	terminal pin housing connecting piece distance sensor	1 pin	1							
30	191 972 702	flat contact housing connecting piece for diagnosis plug	2 pin	1							
(30)	191 972 705	terminal pin housing	5 pin	1	automatic						
32	191 972 712	flat connector housing	2 pin	1							
33	357 972 741	single wiring seal for wire cross section:	5,6X7,8 blue 1,0	X							
34	357 972 751	flat contact housing	1 pin	1							
(34)	191 972 752	flat contact housing	2 pin	1	automatic						



Pos	Part Number	Name	Remarks	Qty	Model
		wiring loom for engine connecting piece valve			AAA
(1)	021 971 595	wiring loom for engine		1	
		single parts			
(2)	N 010 215 27	screw, hexagonal head	M6X15	1	
(3)	443 906 236	flat contact housing PHASESENSOR	3 pin	1	
5	443 906 231	terminal pin housing connecting piece heater crankcase	2 pin	1	
6	037 906 240	flat contact housing connecting piece electronic control unit exhaust recirculation valve exhaust pipe idling stabilisation cylinders 1-4 cylinder 5.6 temperature sender	2 pin NTC	X 1 1 1 4 2 1	
6A	357 906 732 A	angled protective cap		1	
(6B)	357 906 733 B	angled protective cap		1	
8	447 919 141	protective cap		1	
9	357 919 754	flat contact housing connecting piece pump	4 pin	1	
10	021 971 824	cover potentiometer throttle valve		1	
11	021 971 824 B	cable holder connecting piece valve		1	
11A	1H0 971 848 F	cable holder		1	
11B	1H0 971 848 Q	cable holder		1	
12	811 971 867	grommet	10X32	2	



Model	Year	MG	SG	Illustration	VIN No.	Update	17:41	18.02.20100		ETKA	
PA	90	9	71	194-30		336					

Pos	Part Number	Name	Remarks	Qty	Model	Pos	Part Number	Name	Remarks	Qty	Model
13	191 971 922	terminal pin housing connecting piece oil temperature gauge sender	1 pin	1							
14	357 972 740 D	single wiring seal for wire cross section:	3,9X7,8 grey 0,5-1,0	X							
15	357 972 741	single wiring seal for wire cross section:	5,6X7,8 blue 1,0	X							
17	357 972 741 B	single wiring seal for wire cross section:	5,6X7,8 yellow orange 2,5	X							
18	357 972 752	flat contact housing connecting piece pump	2 pin	1							
19	357 972 753	flat contact housing connecting piece potentiometer distance sensor	3 pin	X 1 1							
21	357 972 840	plug	4,0X7,8	3							
(22)	1H0 973 131	flat connector housing connecting piece loom for engine compartment	28 pin	1							

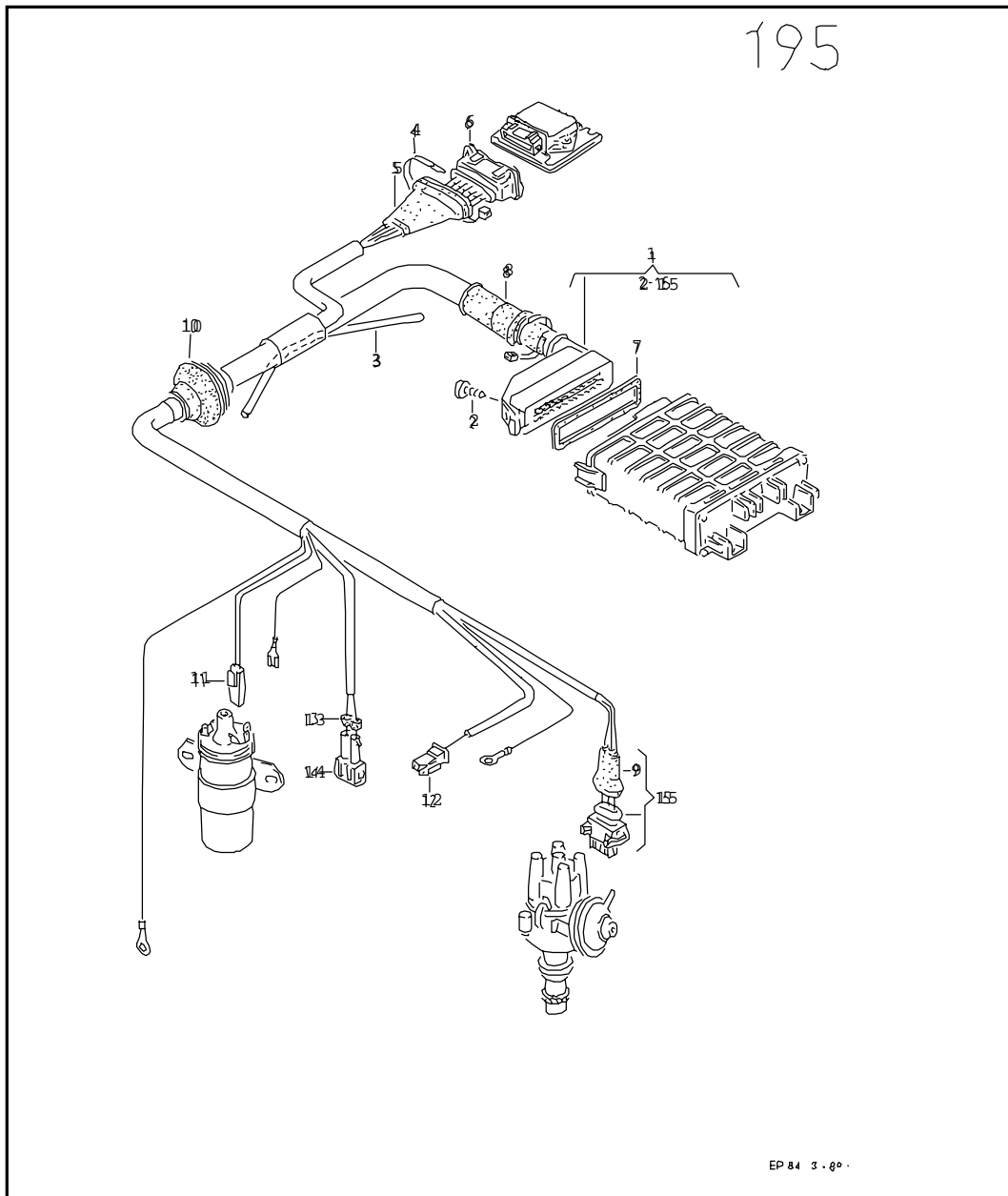

Model	Year	MG	SG	Illustration	VIN No.	Update	17:41	18.02.20100		ETKA	
PA	90	9	71	195-00		336					



Pos	Part Number	Name	Remarks	Qty	Model
		wiring harness for transistorized ignition system			EZ,RF,KR
(1)	357 971 131 A	wiring harness for transistorized ignition system F >> 31-L-400 000		1	EZ,RF
(1)	357 971 132 A	wiring harness for transistorized ignition system F >> 31-L-400 000	lhd	1	KR
(1)	358 971 132 A	wiring harness for transistorized ignition system F >> 31-L-400 000	rhd	1	KR
(1)	357 971 132 B	wiring harness for transistorized ignition system F 31-M-000 001>>	lhd	1	KR
2	N 013 953 2	tapping screw, fill. hd.	B2,9X9,5	1	
3	N 020 139 1	tube in coils of 5m 'order unit 5'	4X1	*	
4	N 900 603 01	cable binder	6,5X175	1	
(5)	037 906 102 A	protective cap terminal pin housing	7 pin	1	
6	071 906 233	flat contact housing	7 pin	1	
7	871 906 375 A	gasket	16X50	X	
8	191 906 376 A	protective cap	20,5X11	1	
(9)	191 906 102	protective cap		1	
(10)	251 971 905 C	grommet	52X16	1	EZ,RF
10	357 971 905 A	grommet	52/16	1	KR
11	111 971 921 B	terminal pin housing	1 pin	1	
12	191 971 922	terminal pin housing connecting piece engine	1 pin NTC	1	KR
13	357 972 741 A	single wiring seal	5,6X7,8 red 1,5	2	
14	357 972 762	flat connector housing connecting piece engine F >> 31-L-400 000 F 31-M-000 001>>	2 pin	1 1	EZ,RF,KR EZ,RF



Model	Year	MG	SG	Illustration	VIN No.	Update	17:41	18.02.20100		ETKA	
PA	90	9	71	195-00		336					

Pos	Part Number	Name	Remarks	Qty	Model	Pos	Part Number	Name	Remarks	Qty	Model
(14)	357 972 763	flat connector housing connecting piece engine F 31-M-000 001>>	3 pin	1	KR						
(15)	443 906 236	flat contact housing	3 pin	1							

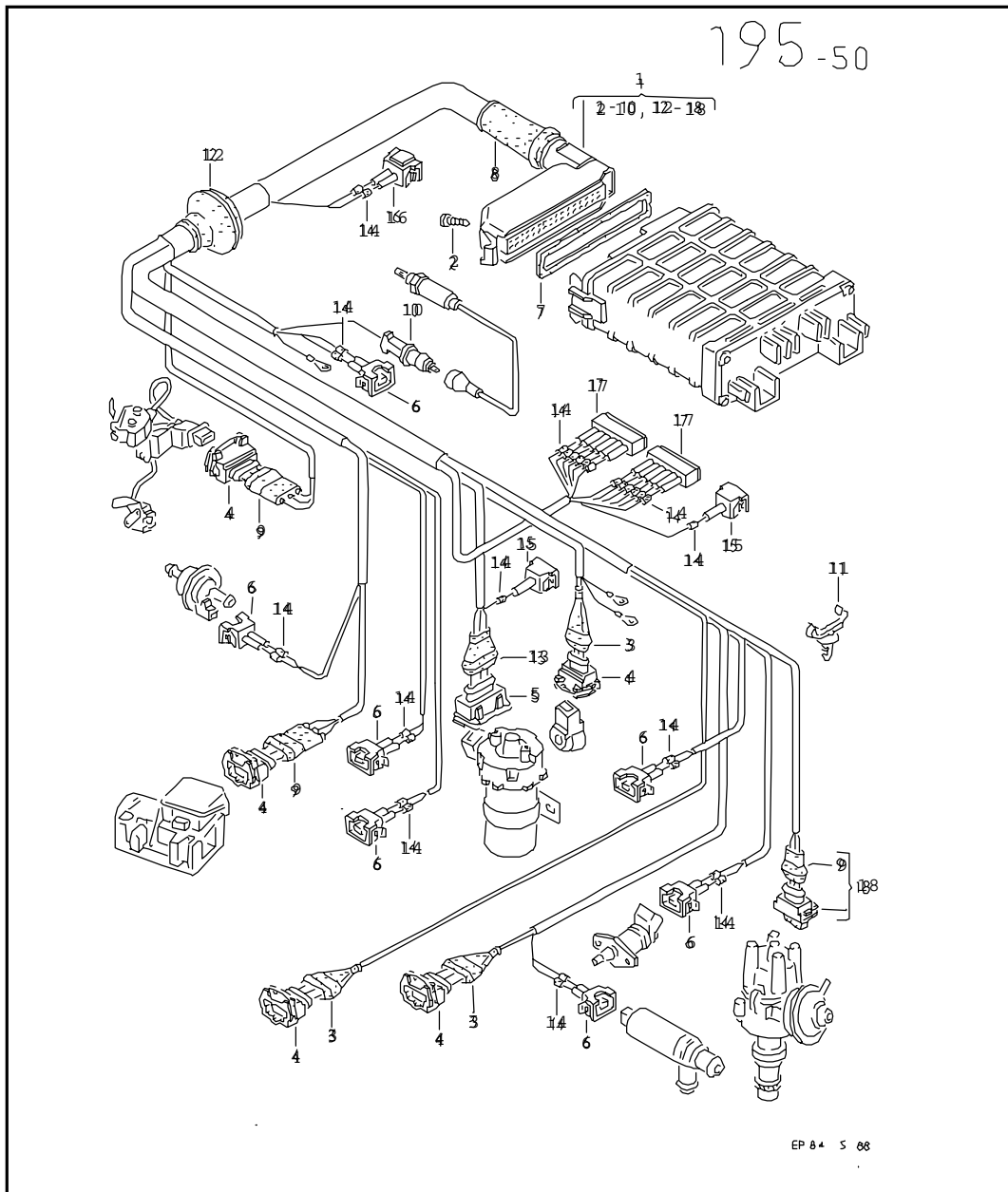
Model	Year	MG	SG	Illustration	VIN No.	Update	17:42	18.02.20100		ETKA	
PA	90	9	71	195-50		336					





Pos	Part Number	Name	Remarks	Qty	Model
1	357 971 133 A	wiring harness for transistorized ignition system F >> 31-L-400 000 ----- F 31-M-000 001>> see illustration: loom, right, front -----	'MOTRONIC':16V		9A
(1)	357 971 133 C	wiring harness for transistorized ignition system ** see current flow diagram ** F >> 31-K-400 000		lhd 1	
(1)	358 971 133 A	wiring harness for transistorized ignition system F >> 31-K-400 000		rhd 1	
(1)	358 971 133 C	wiring harness for transistorized ignition system F 31-L-000 001>>		rhd 1	
2	N 013 953 2	tapping screw, fill. hd.	B2,9X9,5	1	
(3)	443 906 102 B	grommet	18X20,5	X	
(4)	443 906 233	flat contact housing connecting piece idling switch anti-knock sensor air flow meter	3 pin 1+2	X 1 2 1	
5	191 906 232 B	terminal pin housing	3 pin	1	
6	037 906 240	flat contact housing connecting piece coupling piece lambda probe cold starting valve idling stabilisation solenoid valve	2 pin	1 1 1 1 1 1 1	lhd

Model	Year	MG	SG	Illustration	VIN No.	Update	17:42	18.02.20100		ETKA	
PA	90	9	71	195-50		336					

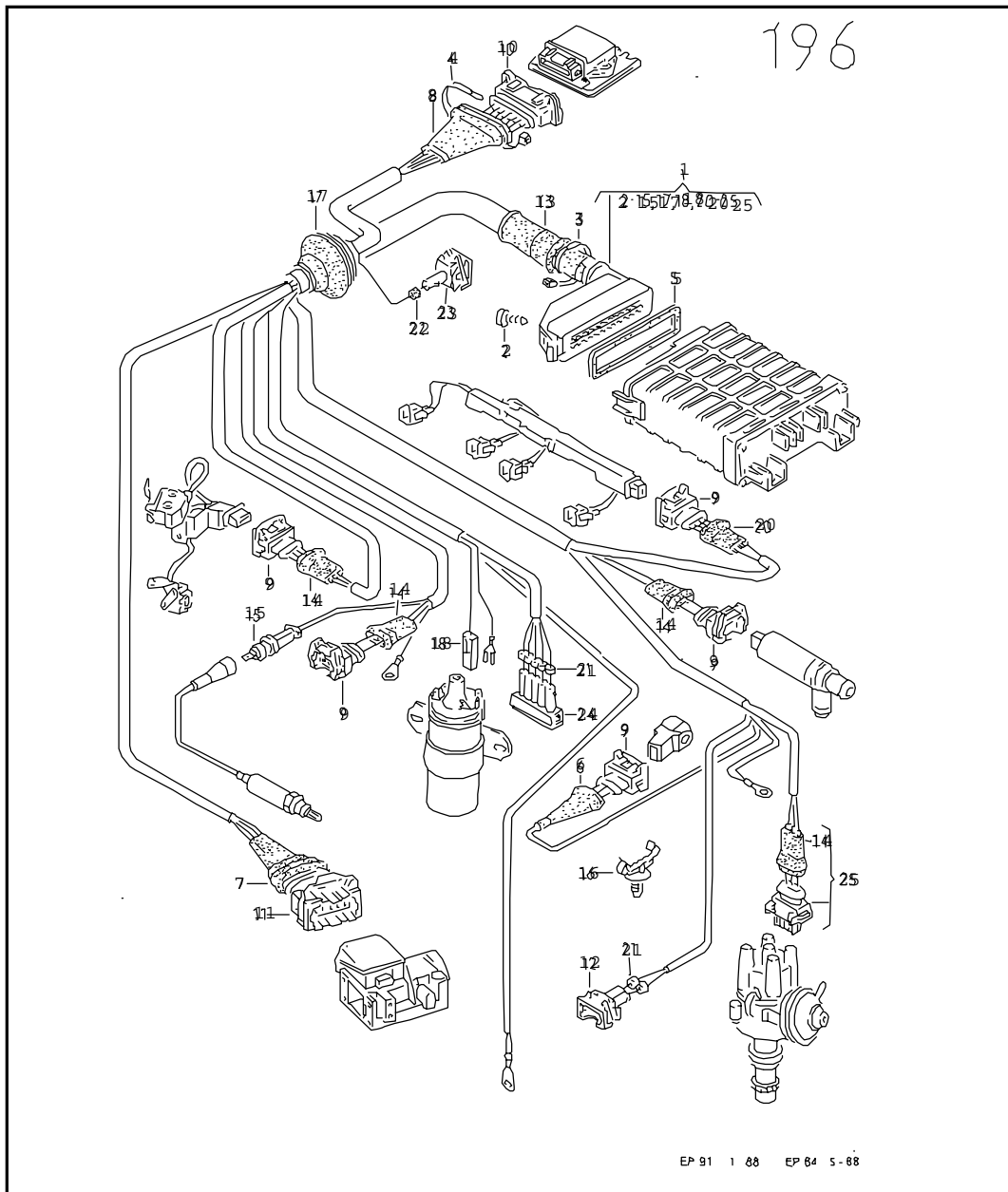
Pos	Part Number	Name	Remarks	Qty	Model	Pos	Part Number	Name	Remarks	Qty	Model
		diff. pressure regulator		1		(17)	357 972 756	flat contact housing	6 pin	X	
		temperature sensor		1		(18)	443 906 236	flat contact housing	3 pin	1	
		valve		1							
(6)	357 972 754	flat contact housing coupling piece lambda probe F >> 31-K-400 000	4 pin rhd	1							
(6)	357 972 754 J	flat contact housing connecting piece lambda probe F 31-L-000 001>>	4 pin rhd	1							
-	191 906 365	flat contact housing with gasket	25 pin	1							
(7)	155 906 375 A	gasket flat contact housing	16X85,5 25 pin	1							
8	191 906 376 A	protective cap	20,5X11	1							
(9)	191 906 102	protective cap		X							
10	323 971 108 C	loom for lambda probe	lhd	1							
(11)	701 971 899 G	bracket flat contact housing	4 pin 5 pin	X X							
(11)	357 971 899 C	bracket flat contact housing	5 pin 6 pin	X X							
12	357 971 905 A	grommet	52/16	1							
(13)	191 927 907	protective cap	16X25	1							
14	357 972 741 A	single wiring seal for wire cross section:	5,6X7,8 red 1,5	X							
15	357 972 751	flat contact housing connecting piece air conduit. ignition coil	1 pin	X 1 1							
16	357 972 752	flat contact housing connecting piece automatic	2 pin	1							
17	357 972 766	flat connector housing connecting piece loom, right, front	6 pin	2							





Pos	Part Number	Name	Remarks	Qty	Model
		wiring harness for transistorized ignition system F >> 31-L-400 000 ----- F 31-M-000 001>> see illustration: loom, right, front -----	'DIGIFANT'		PB,PF
(1)	357 971 758 K	wiring harness for transistorized ignition system	lhd	1	PF
(1)	357 971 758 L	wiring harness for transistorized ignition system	lhd	1	PB
(1)	358 971 758 K	wiring harness for transistorized ignition system	rhd	1	PF
(1)	358 971 758 L	wiring harness for transistorized ignition system	rhd	1	PB
2	N 013 953 2	tapping screw, fill. hd.	B2,9X9,5	1	
(3)	N 020 902 2	cable binder	6X246	X	
4	N 900 603 01	cable binder	6,5X175	X	
5	155 906 375 A	gasket	16X85,5	1	
(6)	443 906 102 B	grommet	18X20,5	1	
(7)	893 945 521	protective cap	28X10,7	1	
(8)	037 906 102 A	protective cap		1	
(9)	443 906 233	flat contact housing	3 pin	X	
10	071 906 233	flat contact housing	7 pin	1	
11	025 906 235 B	flat contact housing	5 pin	1	
12	037 906 240	flat contact housing connecting piece injector engine	2 pin NTC	X 1	
12	037 906 240	flat contact housing connecting piece injector engine	2 pin NTC	X 1	
-	191 906 365	flat contact housing with gasket	25 pin	1	
13	191 906 376 A	protective cap	20,5X11	1	

Model	Year	MG	SG	Illustration	VIN No.	Update	17:43	18.02.20100		ETKA	
PA	90	9	71	196-00		336					

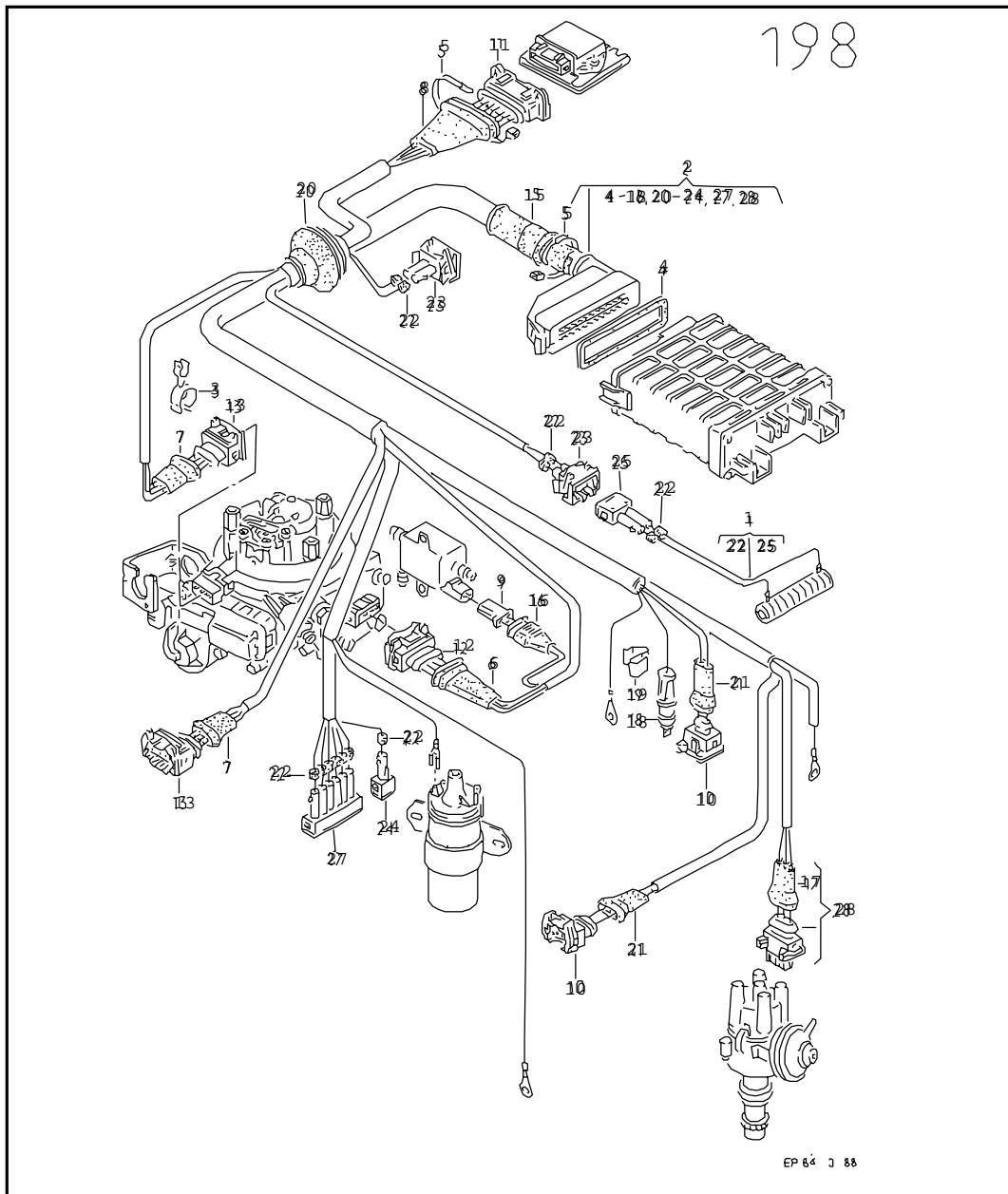

Pos	Part Number	Name	Remarks	Qty	Model	Pos	Part Number	Name	Remarks	Qty	Model
(14)	191 906 102	protective cap		X							
15	--- --- ---	no longer available									
-	191 971 501 A	bracket lambda probe		1							
(16)	701 971 899 G	bracket flat contact housing connecting piece wheel housing wheel housing	4 pin 5 pin left front right front	X X							
(16)	357 971 899 C	bracket flat contact housing connecting piece wheel housing wheel housing	6,5X24,5 5 pin 6 pin left front right front	X X							
17	357 971 905 A	grommet	52/16	1							
18	111 971 921 B	terminal pin housing	1 pin	1							
20	810 972 525	grommet	12,5X31	X							
21	357 972 741	single wiring seal for wire cross section:	5,6X7,8 blue 1,0	X							
22	357 972 741 A	single wiring seal for wire cross section:	5,6X7,8 red 1,5	1							
23	357 972 751	flat contact housing	1 pin	1	air condit.						
(23)	357 972 752	flat contact housing	2 pin	1	automatic						
(23)	357 972 761	flat contact housing coupling piece for diagnosis plug	1 pin	1							
24	357 972 765	flat connector housing connecting piece engine	5 pin	1							
(28)	443 906 236	flat contact housing	3 pin	1							





Pos	Part Number	Name	Remarks	Qty	Model
		wiring harness for transistorized ignition system series resistance ** see current flow diagram ** F >> 31-K-400 000	'MONO-JETRONIC'		1F,RP
1	357 971 284 A	series resistance		1	
-	321 971 280	bracket for resistance		1	
(2)	357 971 770 A	wiring harness for transistorized ignition system for vehicles with regulated catalyst		1hd	1F,RP
2	357 971 770 C	wiring harness for transistorized ignition system for vehicles without catalyst	ECE	1hd	1 RP
(2)	357 971 770 E	wiring harness for transistorized ignition system for vehicles with regulated catalyst		1hd	1 automatic: 1F,RP
(2)	357 971 770 G	wiring harness for transistorized ignition system for vehicles without catalyst	ECE	1hd	1 automatic: RP
(2)	358 971 770 A	wiring harness for transistorized ignition system for vehicles with regulated catalyst		1rhd	1F,RP
(2)	358 971 770 C	wiring harness for transistorized ignition system for vehicles without catalyst	ECE	1rhd	1 RP
(2)	358 971 770 G	wiring harness for transistorized ignition system for vehicles without catalyst	ECE	1rhd	1 automatic: RP
(2)	357 971 770 N	wiring harness for transistorized ignition system for vehicles with regulated catalyst	'MONO-JETRONIC'	1hd	1F,RP

Model	Year	MG	SG	Illustration	VIN No.	Update	17:43	18.02.20100		ETKA	
PA	90	9	71	198-00		336					

Pos	Part Number	Name	Remarks	Qty	Model	Pos	Part Number	Name	Remarks	Qty	Model
(2)	357 971 770 Q	wiring harness for transistorized ignition system for vehicles without catalyst	ECE	1	RP	(6)	893 945 521	protective cap	28X10,7	X	
(2)	358 971 770 N	wiring harness for transistorized ignition system for vehicles with regulated catalyst		1	1F,RP	7	191 906 102	protective cap		2	
(2)	358 971 770 Q	wiring harness for transistorized ignition system for vehicles without catalyst	ECE	1	RP	(8)	037 906 102 A	protective cap		X	
		wiring harness for transistorized ignition system F 31-LE088 000>> 31-LE400 000 F 31-LB019 700>> 31-LB300 000 ----- F 31-M-000 001>> see illustration: loom, right, front -----	'MONO-JETRONIC'	1	1F,RP	9	443 906 231	terminal pin housing F >> 31-LE087 999 F >> 31-LB019 699	2 pin	1 1	
(2)	357 971 770 J	wiring harness for transistorized ignition system for vehicles with regulated catalyst		1	1F,RP	(9)	037 906 240	flat contact housing also use: F 31-LE088 000>> F 31-LB019 700>>	2 pin 357 972 741 A	1 1	
(2)	357 971 770 L	wiring harness for transistorized ignition system for vehicles without catalyst	ECE	1	RP	-	191 971 501 A	bracket lambda probe		1	
(2)	358 971 770 J	wiring harness for transistorized ignition system for vehicles with regulated catalyst		1	1F,RP	(10)	443 906 232	flat contact housing connecting piece lambda probe water pipe F >> 31-K-400 000	2 pin heater NTC	1 1 X	
(2)	358 971 770 L	wiring harness for transistorized ignition system for vehicles without catalyst	ECE	1	RP	(10)	037 906 240	flat contact housing connecting piece lambda probe water pipe F 31-L-000 001>> also use:	2 pin 357 972 741 A	4	
(2)	049 127 621	bracket		X		11	071 906 233	flat contact housing connecting piece switch unit 'tci' throttle valve positioner	7 pin	X	
(2)	155 906 375 A	gasket	16X85,5	X		12	025 906 235 B	flat contact housing connecting piece sender for throttle position contact F >> 31-LE087 999 F >> 31-LB019 699	5 pin	X	
(5)	N 020 902 2	cable binder	6X246	1				contact N 903 352 03 F >> 31-LE087 999 F >> 31-LB019 699 contact N 903 352 07 F 31-LE088 000>> F 31-LB019 700>>	gold plated	4 4 4	

Model	Year	MG	SG	Illustration	VIN No.	Update	17:43	18.02.20100		ETKA	
PA	90	9	71	198-00		336					

Pos	Part Number	Name	Remarks	Qty	Model	Pos	Part Number	Name	Remarks	Qty	Model
(13)	4A0 906 234	flat contact housing connecting piece throttle valve positioner injector	4 pin NTC	X 1 1		(25)	037 906 240	flat contact housing also use: connecting piece cut-off valve F 31-LE000 001>> 31-LE087 999 F 31-LB000 001>> 31-LB019 699 cold start valve F 31-L-000 001>>	2 pin 357 972 741 A	4	
-	191 906 365	flat contact housing with gasket	25 pin	1							
15	191 906 376 A	protective cap	20,5X11	1		(27)	357 972 764	flat connector housing connecting piece automatic F >> 31-K-400 000	4 pin	1	
16	447 919 141	protective cap F >> 31-LE087 999 F >> 31-LB019 699		1 1		27	357 972 766	flat connector housing connecting piece loom	6 pin front	1	
(17)	191 906 102	protective cap		1		(28)	443 906 236	flat contact housing	3 pin	1	
18	323 971 108 C	loom for lambda probe also use: N 903 352 03		1 1							
-	357 972 851 A	cable holder connecting piece bracket F 31-L-000 001>>		1							
19	321 971 897	clip		X							
20	357 971 905 A	grommet	52/16	1							
-	443 972 525	grommet connecting piece cut-off valve		1							
21	810 972 525	grommet F >> 31-K-400 000	12,5X31	X							
22	357 972 741 A	single wiring seal for wire cross section:	5,6X7,8 red 1,5	X							
23	357 972 752	flat contact housing connecting piece air conduit. F 31-J-000 001>> coupling piece series resistance F >> 31-K-400 000	2 pin	1 1 X							
24	357 972 761	flat contact housing	1 pin	1							
25	357 972 762	flat connector housing	2 pin	1							
(25)	443 906 232	flat contact housing connecting piece cut-off valve cold start valve F >> 31-K-400 000	2 pin	1 1 X							

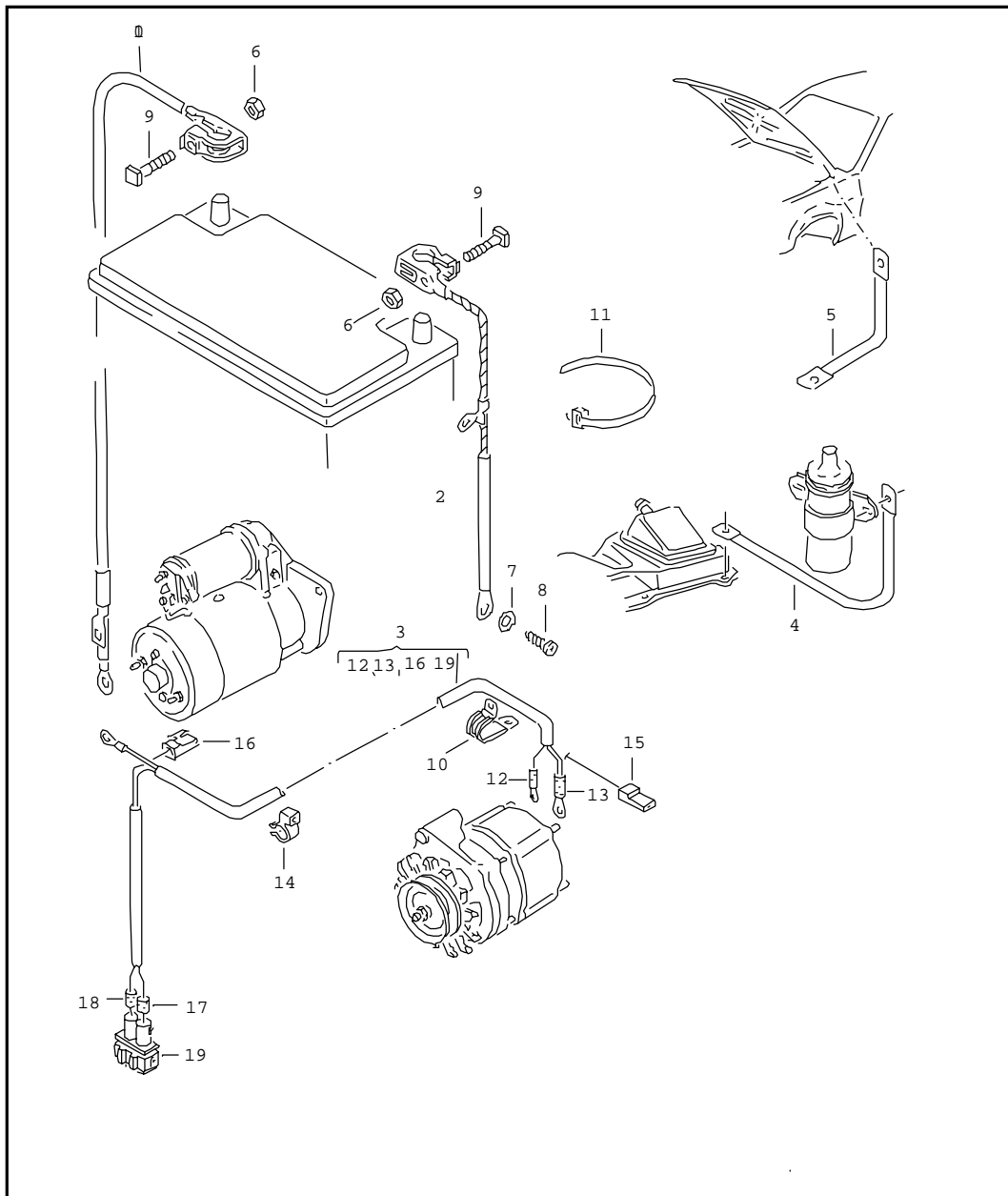

Model	Year	MG	SG	Illustration	VIN No.	Update	17:44	18.02.20100		ETKA	
PA	90	9	71	212-00		336					



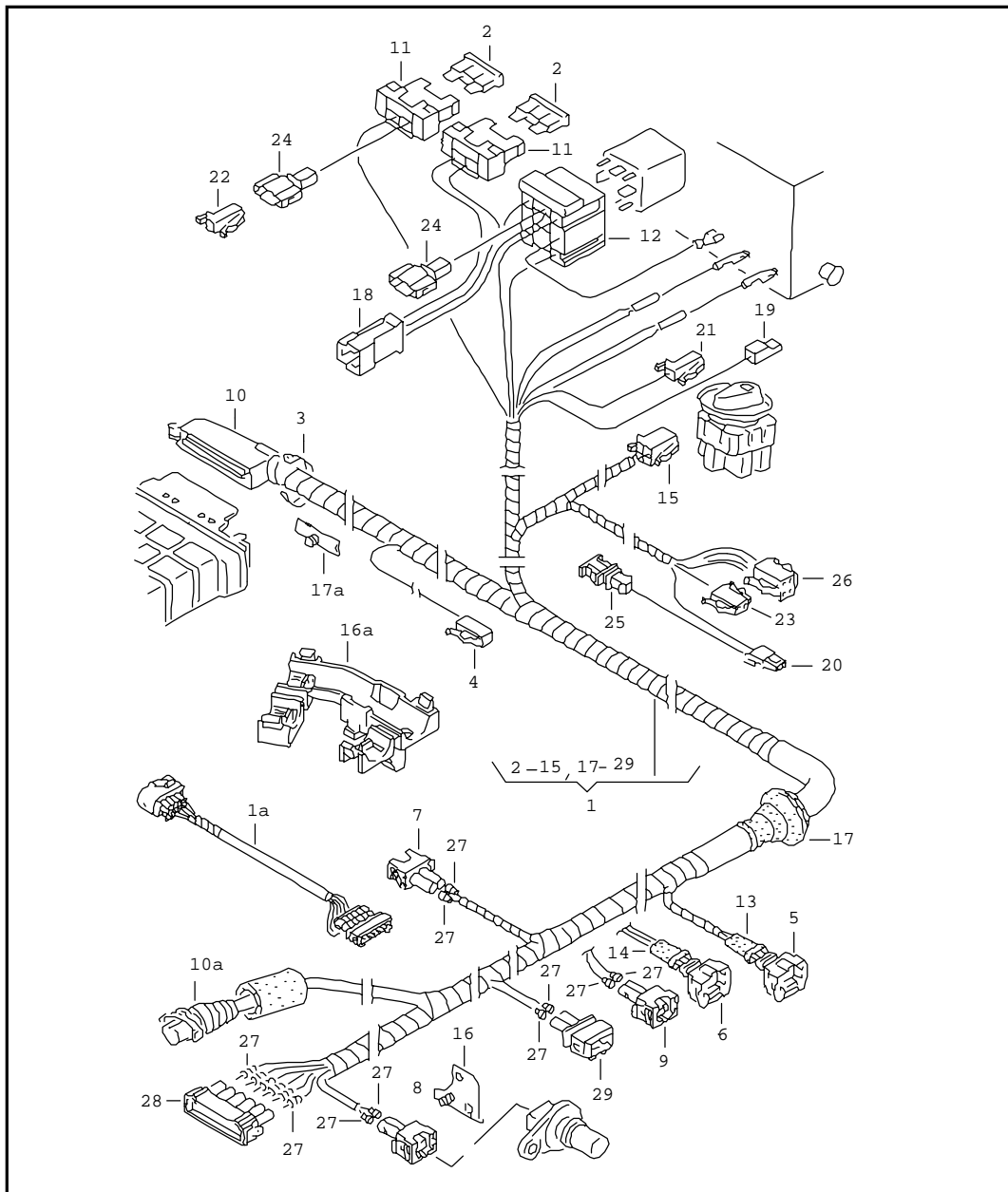

Pos	Part Number	Name	Remarks	Qty	Model
		wiring looms for battery and alternator ground strap			
(1)	357 971 228 C	wiring loom for battery +	420MM	1	
2	357 971 235 C	wiring loom for battery -		1	
(3)	357 971 349 C	wiring harness for alternator	730MM	1	diesel eng.
		also use:	357 972 761	1	otto engine
(3)	357 971 349 E	wiring harness for alternator	1000MM	1	air condit.
		also use:	357 972 761	X	
(3)	357 971 349 G	wiring harness for alternator	840MM	1	6 cylinder
4	357 971 537	ground strap	360MM	1	
5	533 971 537	ground strap flap, front		1	
6	N 011 006 24	hex. nut	M6	2	
7	N 012 121 2	shake-proof washer	A4,3	1	
8	N 013 965 5	tapping screw, fill. hd.	B4,2X9,5	1	
9	N 017 405 2	screw	M6X38	2	
10	N 020 620 1	clip	D1-13X15	1	
11	N 900 603 01	cable binder	6,5X175	X	
12	803 971 892	grommet	3X25	1	
13	803 971 896	grommet	4X30	1	
14	155 971 898	clip		1	
15	111 971 921 B	terminal pin housing	1 pin	1	diesel eng.
17	357 972 741	single wiring seal	5,6X7,8 blue	1	otto engine
		for wire cross section:	1,0	2	diesel eng.
(19)	357 972 761	flat contact housing	1 pin	1	otto engine
19	357 972 762	flat connector housing	2 pin	1	diesel eng.
-	535 971 359	cable holder solenoid		1	





Pos	Part Number	Name	Remarks	Qty	Model
		loom for 4 speed automatic gearbox F >> 31-L-400 000			
(1)	357 971 774 AB	loom for 4 speed automatic gearbox	1.8ltr.	1	DIGIFANT
(1)	357 971 774 AR	loom for 4 speed automatic gearbox	2.0ltr.	1	DIGIFANT
(1)	357 971 774 AP	loom for 4 speed automatic gearbox		1	
(1)	358 971 774 L	loom for 4 speed automatic gearbox	1.8ltr.	1	DIGIFANT
(1)	358 971 774 S	loom for 4 speed automatic gearbox		1	16V
		loom for 4 speed automatic gearbox F 31-M-000 001>>			
(1)	357 971 774 BB	loom for 4 speed automatic gearbox		1	diesel eng.
(1)	357 971 774 BD	loom for 4 speed automatic gearbox		1	MONO-JETRONIC, MONO-MOTRONIC
(1)	357 971 774 CK	loom for 4 speed automatic gearbox		1	DIGIFANT
		connecting piece throttle valve potentiometer	also use: >>31-M-280000 N 903 352 03	3	
(1)	357 971 774 BM	loom for 4 speed automatic gearbox		1	16V
(1)	358 971 774 AG	loom for 4 speed automatic gearbox		1	MONO-JETRONIC
(1)	358 971 774 AJ	loom for 4 speed automatic gearbox		1	16V
(1)	358 971 774 BC	loom for 4 speed automatic gearbox		1	DIGIFANT

Model	Year	MG	SG	Illustration	VIN No.	Update	17:44	18.02.20100		ETKA	
PA	90	9	71	214-00		336					

Pos	Part Number	Name	Remarks	Qty	Model	Pos	Part Number	Name	Remarks	Qty	Model
		----- see list of locally- made looms -----	see no.: 25			11	161 937 501	fuse box for flat fuses for vehicles with cruise control system	2 pin	1	
		single parts									
		self made piece				12	161 937 501 B	relay plate	9 pin	1	
1A						(13)	893 945 521	protective cap	28X10,7 1.8ltr.	1	DIGIFANT
2	N 017 131 3	flat fuse 19/2x5 for vehicles with cruise control system	5-light brown AMP	1 2		(13)	191 906 102	protective cap		1	16V
3	N 020 902 2	cable binder F >> 31-L-400 000	6X246	1		(14)	191 906 102	protective cap		1	diesel eng.
4	191 906 231 A	flat contact housing	2 pin	1		15	357 959 869	terminal pin housing F >> 31-L-400 000	5 pin	1	
5	443 906 233	flat contact housing throttle valve potentiometer	3 pin	1		(15)	191 972 722	terminal pin housing F 31-M-000 001>>	4 pin	1	
(5)	4A0 906 234	flat contact housing	4 pin 1.8ltr.	1	DIGIFANT	16	191 971 843 B	bracket		1	
(5)	357 972 754	flat contact housing	4 pin 2.0ltr.	1	DIGIFANT	(17)	357 971 905 E	grommet	46/16	1	
(5)	357 972 755	flat contact housing	5 pin	1	MONO- JETRONIC: police	18	161 971 975	flat connector housing connecting piece loom, left, front	3 pin	1	
6	443 906 233	flat contact housing	3 pin	1	diesel eng.	19	431 971 995	terminal pin housing	1 pin	1	
7	037 906 240	flat contact housing full throttle switch	2 pin	1		19	431 971 995	terminal pin housing	1 pin	1	
7	037 906 240	flat contact housing full throttle switch	2 pin	1		20	443 972 577 E	flat contact housing for diagnosis plug	2 pin	1	
8	037 906 240	flat contact housing	2 pin	1		21	191 972 701	terminal pin housing connecting piece loom for air conditioner operation	1 pin	1	
9	037 906 240	flat contact housing speed sensor engine	2 pin	1	diesel eng.	22	191 972 701	terminal pin housing	1 pin	1	
10	191 906 370	flat contact housing with gasket	38 pin	1		23	191 972 702	flat contact housing	2 pin	1	
-	191 927 397	lock ring rd. connector sleeve housing valve body		1		24	191 972 711	flat connector housing	1 pin	2	
						25	191 972 711	flat connector housing connecting piece loom for anti locking brake system -abs-	1 pin	1	
						26	191 972 722	terminal pin housing connecting piece loom for automatic selector lever	4 pin	1	



Model	Year	MG	SG	Illustration	VIN No.	Update	17:44	18.02.20100		ETKA	
PA	90	9	71	214-00		336					

Pos	Part Number	Name	Remarks	Qty	Model	Pos	Part Number	Name	Remarks	Qty	Model
27	357 972 741 A	single wiring seal for wire cross section:	5,6X7,8 red 1,5	X							
28	357 972 756	flat contact housing connecting piece wiring harnessadapter multi-function switch for automatic transmission	6 pin	1							
29	357 972 762	flat connector housing connecting piece wiring harness for transistorized ignition system	2 pin	1							
-	357 972 841	plug flat contact housing throttle valve potentiometer	5,6X7,8 2.0ltr.	1	DIGIFANT						

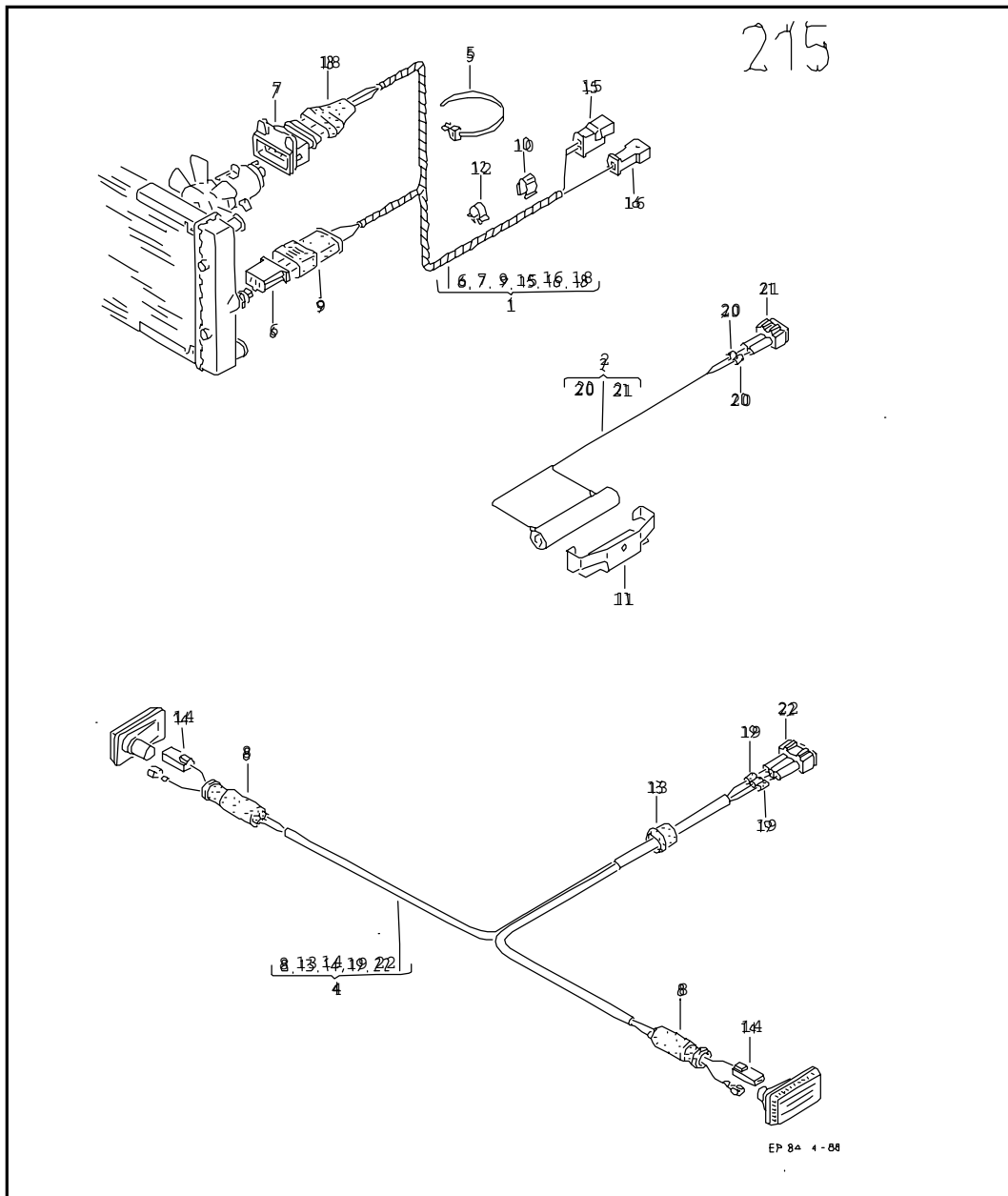
Model	Year	MG	SG	Illustration	VIN No.	Update	17:45	18.02.20100		ETKA	
PA	90	9	71	215-00		336					





Pos	Part Number	Name	Remarks	Qty	Model
(1)	357 971 281 D	wiring harness for electric fan loom for dim-dip driving lights loom for turn signal	side		"GB."
		also use:	>>31-K-400000	1	
			171 971 934	1	
			161 971 976 A	1	
(1)	357 971 281 E	wiring harness for electric fan	F >> 31-L-400 000		
(1)	357 971 281 G	wiring harness for electric fan for vehicle use in warm countries and/or for vehicles with trailers and/or automatic	F 31-M-000 001>>	1	AAZ,1Y,AAA
(1)	357 971 281 G	wiring harness for electric fan	F 31-M-000 001>>	1	TAXI, ADAC police fire brigade post emerg.doctor
2	535 971 284	wiring loom for dim-dip driving lights		1	"GB."
4	357 971 337	wiring loom for side turn signal		1	
-	N 012 225 3	spring washer	B5X11X0,5	2	1Y
-	N 014 128 11	fillister hd. screw	M5X8	2	1Y

Model	Year	MG	SG	Illustration	VIN No.	Update	17:45	18.02.20100		ETKA	
PA	90	9	71	215-00		336					

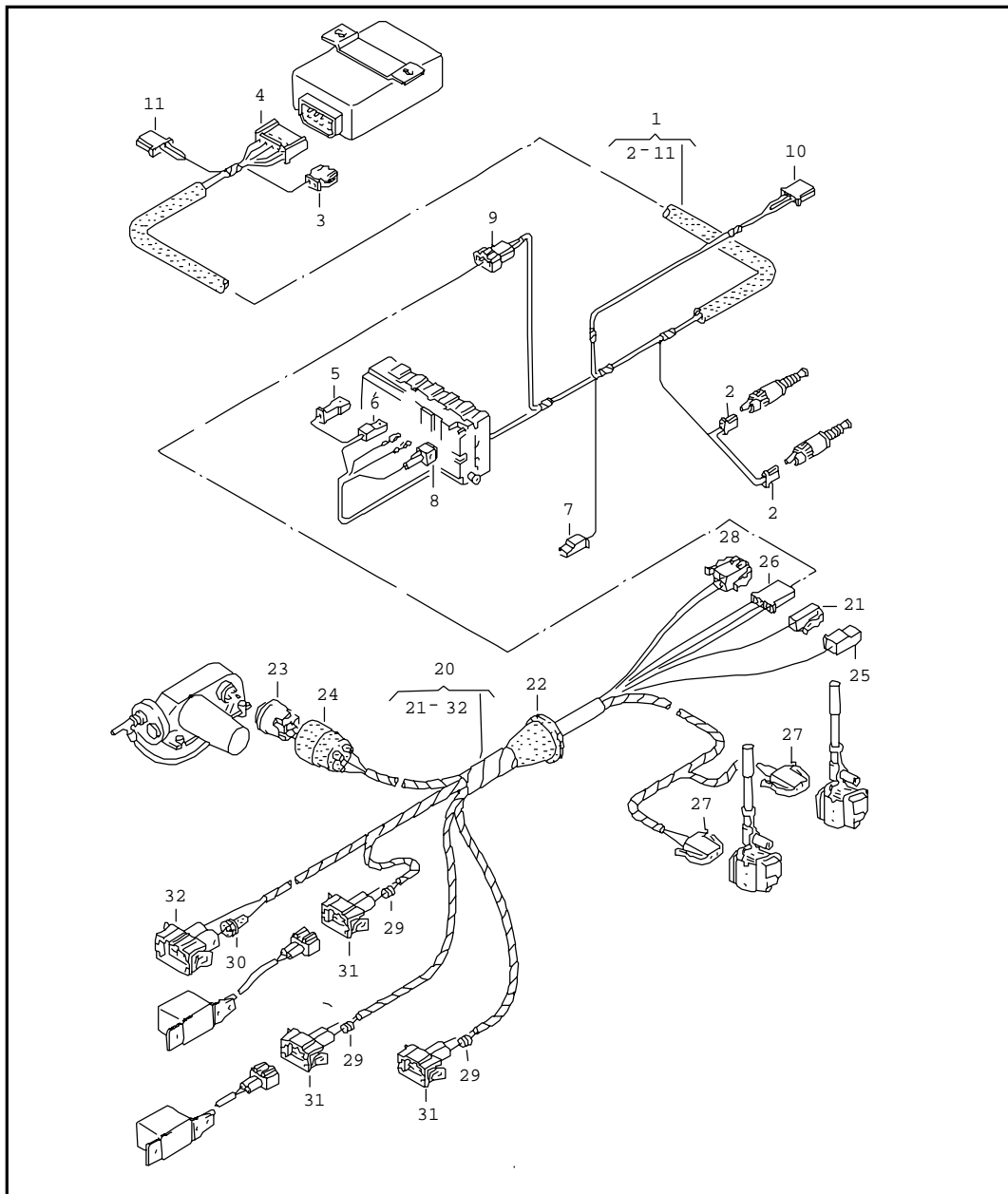
Pos	Part Number	Name	Remarks	Qty	Model	Pos	Part Number	Name	Remarks	Qty	Model
-	N 017 125 1	fuse F 13-M-000 001>>	B50	1		-	357 972 742 B	single wiring seal for wire cross section:	9,0X7,8 red 2,5	X	
5	N 900 603 01	cable binder	6,5X175	X		(15)	357 972 783	flat connector housing connecting piece loom, left, front F 31-L-000 001>>	3 pin	1	
(6)	893 906 231	terminal pin housing	3 pin	1		16	161 971 976 A	flat connector housing connecting piece loom, left, front F >> 31-K-400 000	1 pin	1	carburetor engine
7	191 906 232 B	terminal pin housing F >> 31-L-400 000	3 pin	1		(18)	191 927 907	protective cap F >> 31-L-400 000	16X25	1	
(7)	1H0 906 233	flat contact housing F 31-M-000 001>>	3 pin	1		19	357 972 741	single wiring seal for wire cross section:	5,6X7,8 blue 1,0	3	
-	037 906 240	flat contact housing F 31-M-000 001>>	2 pin	1	1Y	20	357 972 741 A	single wiring seal for wire cross section:	5,6X7,8 red 1,5	2	
-	251 937 501 B	relay plate F 31-M-000 001>>	9 pin	1	1Y	-	357 972 744	single wiring seal for wire cross section: F 31-M-000 001>>	16,2X15,0 orange 4,0	2	1Y
-	161 937 501 B	relay plate F 31-M-000 001>>	9 pin	1	1Y	-	357 972 744	single wiring seal for wire cross section: F 31-M-000 001>>	16,2X15,0 orange 4,0	2	1Y
8	447 953 331 A	grommet terminal pin housing	15X48 4 pin	2		-	357 972 761	flat contact housing F 31-M-000 001>>	1 pin	1	
(9)	867 972 525 B	grommet thermo switch	26X13 3 pin	1		21	357 972 762	flat connector housing	2 pin	1	
10	803 959 849	bracket		X		22	357 972 763	flat connector housing	3 pin	1	
11	321 971 280	bracket for resistance		1		-	1H0 973 204	flat contact housing F 31-M-000 001>>	4 pin	1	1Y
(12)	N 902 055 01	cable binder	4,5X140	X		-	357 972 741 A	single wiring seal for wire cross section: F 31-M-000 001>>	5,6X7,8 red 1,5	3	1Y
13	311 971 907	grommet	23,5/4	1		-	357 972 742	single wiring seal for wire cross section: F 31-M-000 001>>	9,0X7,8 yellow 1,0	1	
(13)	111 971 907	grommet	24/8,5	X							
14	111 971 921 B	terminal pin housing	1 pin	2							
15	171 971 934	terminal pin housing connecting piece loom, left, front F >> 31-K-400 000	2 pin	1							



Pos	Part Number	Name	Remarks	Qty	Model
		loom for cruise control system			
		----- see list of locally- made looms -----	see no.: 26		
(1)	357 971 425 H	loom for cruise control system F >> 31-L-400 000		1	
(1)	357 971 425 M	loom for cruise control system F 13-M-000 001>>		1	
(1)	357 971 425 J	loom for cruise control system F >> 31-L-400 000		1	automatic
(1)	357 971 425 N	loom for cruise control system F 31-M-000 001>>		1	automatic
2	443 906 231	terminal pin housing	2 pin	2	
3	893 971 632	flat contact housing	3,5	1	
4	811 971 971	flat contact housing	8 pin	1	
5	161 971 976 A	flat connector housing F >> 31-L-400 000	1 pin	1	
6	161 971 990 A	terminal pin housing F >> 31-L-400 000	1 pin	1	
(6)	701 906 231	flat contact housing F 31-M-000 001>>	2.8MM	1	
7	431 971 995	terminal pin housing	1 pin	1	
8	357 972 761	flat contact housing	1 pin	1	
9	171 971 998 B	round connector housing	3 pin	1	
10	171 971 999 C	rd. connector sleeve housing F >> 31-L-400 000	4 pin	1	
(10)	191 972 704	terminal pin housing F 31-M-000 001>>	4 pin	1	
11	171 971 999 C	rd. connector sleeve housing test socket	4 pin	1	

Model	Year	MG	SG	Illustration	VIN No.	Update	17:45	18.02.20100		ETKA	
PA	90	9	71	217-00		336					

Pos	Part Number	Name	Remarks	Qty	Model	Pos	Part Number	Name	Remarks	Qty	Model
		loom for belt tensioner and/or cruise control system for vehicles with anti-theft alarm system	pump								
		----- see list of locally- made looms -----	see no. : 27								
20	357 971 425 Q	loom for belt tensioner and/or cruise control system for vehicles with anti-theft alarm system	pump	lhd 1							
(20)	358 971 425 D	loom for belt tensioner and/or cruise control system for vehicles with anti-theft alarm system	pump	rhhd 1							
21	701 906 231	flat contact housing	1 pin	1							
22	113 941 189	grommet	24/6	1							
23	113 945 525	terminal pin housing	3 pin	1							
24	171 957 911	boot terminal pin housing	5 pin	1							
25	431 971 995	terminal pin housing	1 pin	1							
26	171 971 999 B	rd. connector sleeve housing	3 pin	1							
27	191 972 702	flat contact housing	2 pin	2							
28	191 972 722	terminal pin housing connecting piece loom for anti-theft alarm system	4 pin	1							
29	357 972 741	single wiring seal for wire cross section:	5,6X7,8 blue 1,0	X							
30	357 972 743	single wiring seal for wire cross section:	9,0X23,5 blue 1,5	X							
31	357 972 752	flat contact housing	2 pin	3							
32	357 972 772	flat contact housing	2 pin	1							

218

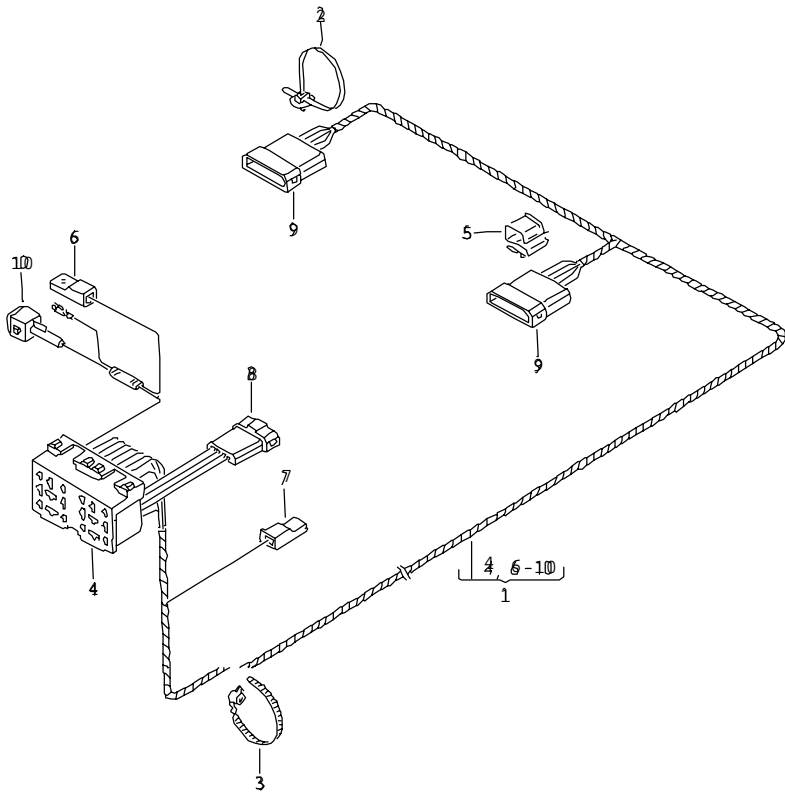

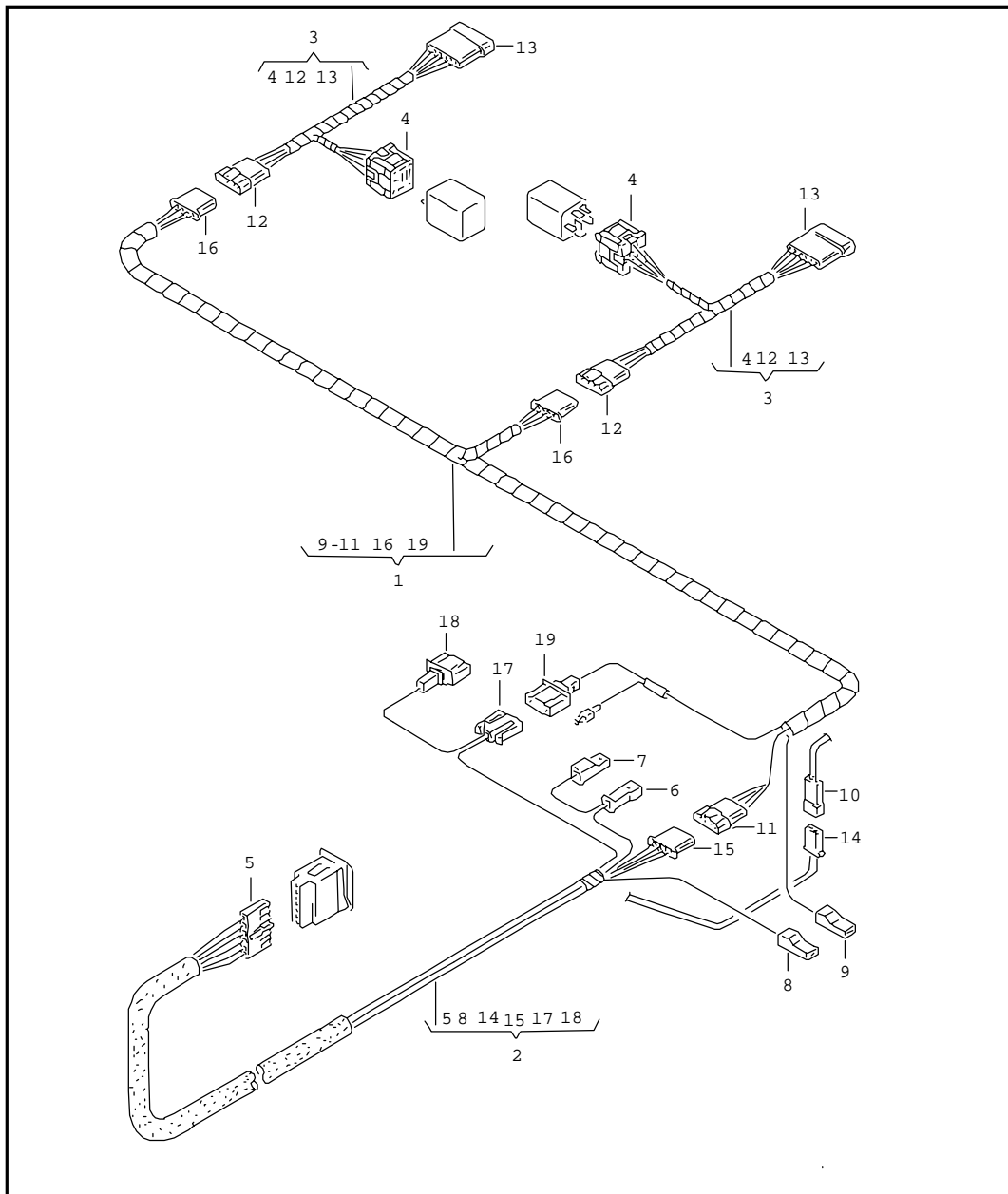

EP 84 -.-9

Pos	Part Number	Name	Remarks	Qty	Model
		loom for heated seats F >> 31-K-240 000			
		----- see list of locally- made looms -----	see no. : 10		
1	357 971 381 B	loom for heated seats		1	
2	N 902 055 01	cable binder	4,5X140	X	
3	N 904 288 01	cable binder with bracket for welded pin:	10X185 5	X	
(4)	161 937 501 B	relay plate (passenger side)	9 pin	2	
4	357 937 501	relay plate (driver and passenger side)	18 pin	1 1	
5	191 971 842 A	cable holder		2	
6	161 971 990 A	terminal pin housing	1 pin	1	
7	431 971 995	terminal pin housing	1 pin	1	
8	171 971 998 C	round connector housing connecting piece	4 pin	1	
9	171 971 998 E	round connector housing (drivers side) (driver and passenger side)	6 pin	1 2	
10	357 972 761	flat contact housing	1 pin	1	



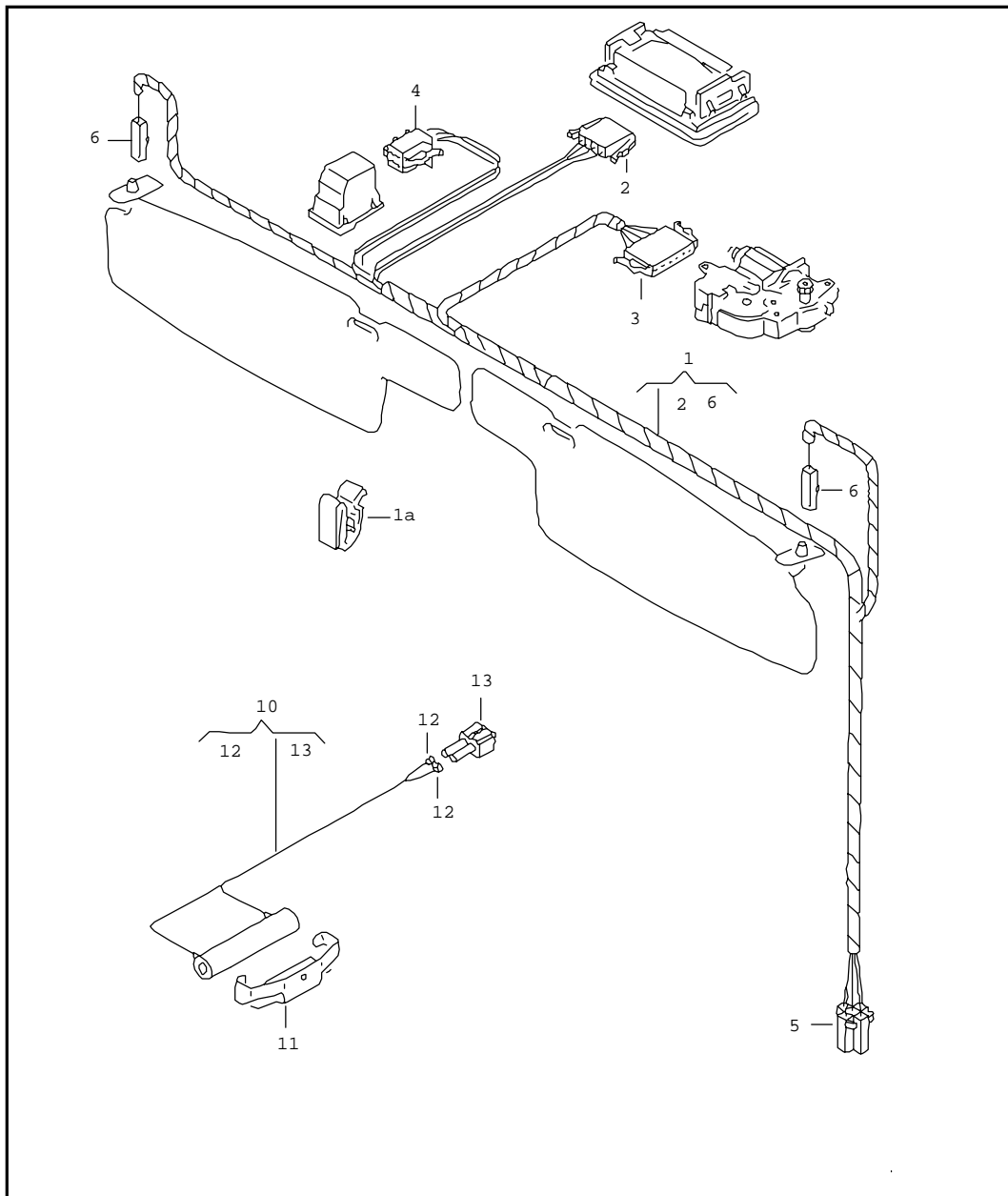

Pos	Part Number	Name	Remarks	Qty	Model
		loom for heated seats F 31-L-000 001>>			
		----- see list of locally- made looms -----	see no. : 10		
1	357 971 381 D	loom for heated seats		1	
3	357 971 382	loom for heated seats relay		2	
4	161 937 501 B	relay plate	9 pin	2	
-	161 971 990 A	terminal pin housing	1 pin	1	
9	431 971 995	terminal pin housing ground connector	1 pin	1	
11	171 971 998 C	round connector housing connecting piece loom switch	4 pin	1	
12	171 971 998 C	round connector housing	4 pin	2	
13	171 971 998 E	round connector housing	6 pin	2	
16	171 971 999 C	rd. connector sleeve housing	4 pin	2	
19	191 972 711	flat connector housing clip	1 pin 15A	1	

Model	Year	MG	SG	Illustration	VIN No.	Update	17:46	18.02.20100		ETKA	
PA	90	9	71	219-00		336					





Pos	Part Number	Name	Remarks	Qty	Model
1	357 971 101 AD	loom for electric sliding roof and/or interior light			
		as required use:	191 906 231 B	1	
			171 971 999 B	1	
		** see current flow diagram ** F 31-M-000 001>>		1	
		----- see list of locally-made looms F >> 31-L-400 000 -----	see no.: 2,13		
(2)	171 971 999 B	rd. connector sleeve housing for vehs. with reading light	3 pin front/rear	1	
(2)	191 906 231 B	flat contact housing for vehicles with electric sliding roof or for vehicles without reading light	3 pin	1	
(2)	171 971 999 C	rd. connector sleeve housing connecting piece loom for reading light	4 pin rear	1	TAXI
(2)	191 972 704	terminal pin housing for vehs. with reading light		1	
(3)	161 971 970	terminal pin housing	3 pin	1	
(4)	357 959 869	terminal pin housing	5 pin	1	
(5)	161 971 989 C	terminal pin housing	2 pin	1	TAXI
-	431 971 995	terminal pin housing for vehicles with electric sliding roof ground connector	1 pin	1	
(6)	171 971 999 A	rd. connector sleeve housing	2 pin	2	
-	191 972 722	terminal pin housing connecting piece loom, rear	4 pin	1	

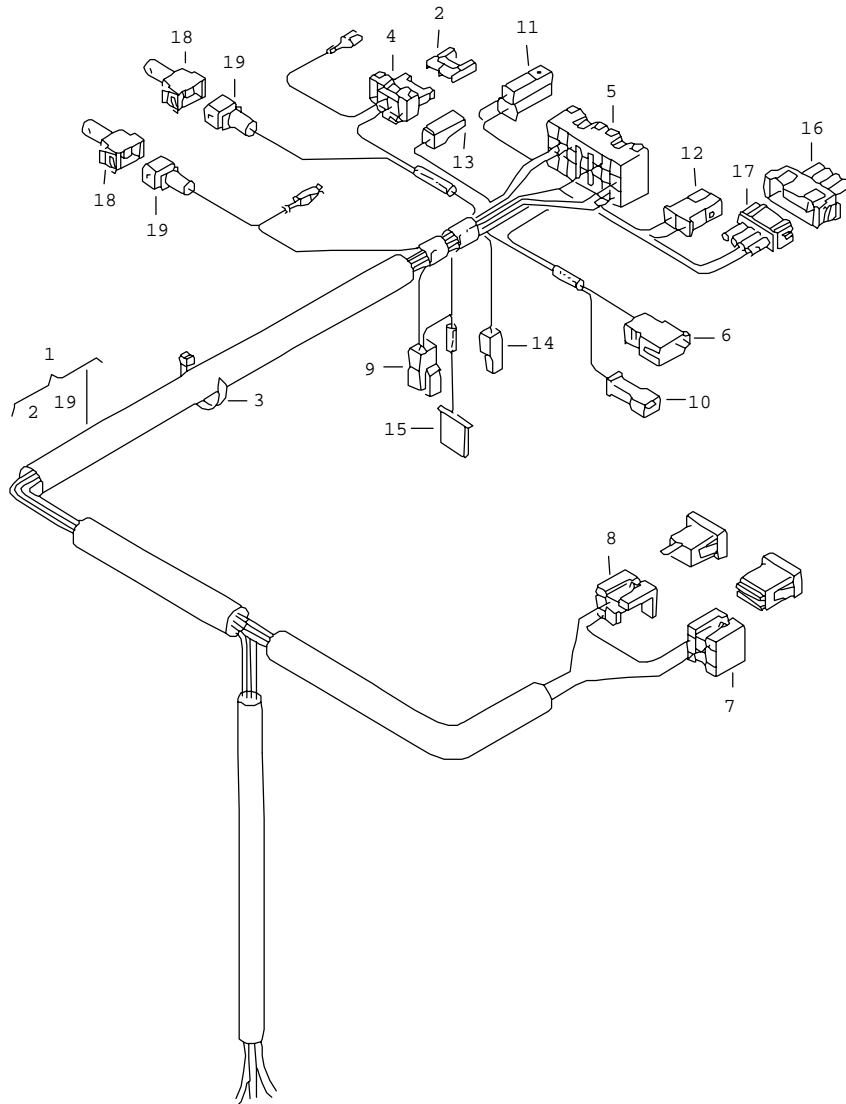

Model	Year	MG	SG	Illustration	VIN No.	Update	17:46	18.02.20100		ETKA	
PA	90	9	71	221-00		336					



Pos	Part Number	Name	Remarks	Qty	Model
1	357 971 267 C	loom for taxameter and alarm system		1	TAXI
(1)	357 971 267 F	loom for taxameter and alarm system F >> 31-L-400 000		1	
			also use: 161 971 988 C	1	
		----- see list of locally-made looms -----	see no.: 23	1	
2	N 017 131 6	flat fuse 19/2x5	15-light blue AMP	1	
3	N 020 902 2	cable binder	6X246	1	
4	161 937 501	fuse box for flat fuses	2 pin	1	
5	443 937 501 B	relay plate	9 pin	2	
6	333 941 973	flat contact housing with helper contact catch connecting piece loom steering col. combi switch	6 pin	1	
7	701 941 997	terminal pin housing	5 pin	1	
8	357 971 837	flat contact housing	5 pin	1	
9	171 971 934	terminal pin housing	2 pin	1	
10	161 971 976 A	flat connector housing F >> 31-L-400 000	1 pin	1	
(10)	191 972 711	flat connector housing F 31-M-000 001>>	1 pin	1	
11	161 971 988 C	flat connector housing connecting piece loom for interior light	2 pin	1	
12	161 971 988 C	flat connector housing connecting piece loom steering col. combi switch F >> 31-L-400 000	2 pin	1	

Model	Year	MG	SG	Illustration	VIN No.	Update	17:46	18.02.20100		ETKA	
PA	90	9	71	221-00		336					

Pos	Part Number	Name	Remarks	Qty	Model	Pos	Part Number	Name	Remarks	Qty	Model
(12)	191 972 712	flat connector housing connecting piece loom steering col. combi switch F 31-M-000 001>>	2 pin	1							
13	161 971 990 A	terminal pin housing connecting piece hall sender F >> 31-L-400 000	1 pin	1							
(13)	701 906 231	flat contact housing connecting piece hall sender F 31-M-000 001>>	2.8MM	1							
14	431 971 995	terminal pin housing ground connector	1 pin	1							
15	171 971 999 C	rd. connector sleeve housing F >> 31-L-400 000	4 pin	1							
(15)	191 972 722	terminal pin housing F 31-M-000 001>>	4 pin	1							
16	357 972 754	flat contact housing F 31-L-400 000>>	4 pin	1							
(16)	191 972 704	terminal pin housing F 31-M-000 001>>	4 pin	1							
17	357 972 764	flat connector housing F >> 31-L-400 000	4 pin	1							
(17)	191 972 714	flat connector housing F 31-M-000 001>>	4 pin	1							
18	357 972 771	flat contact housing	1 pin	2							
19	357 972 781	flat contact housing	1 pin	2							

Model	Year	MG	SG	Illustration	VIN No.	Update	17:47	18.02.20100		ETKA	
PA	90	9	71	224-00		336					

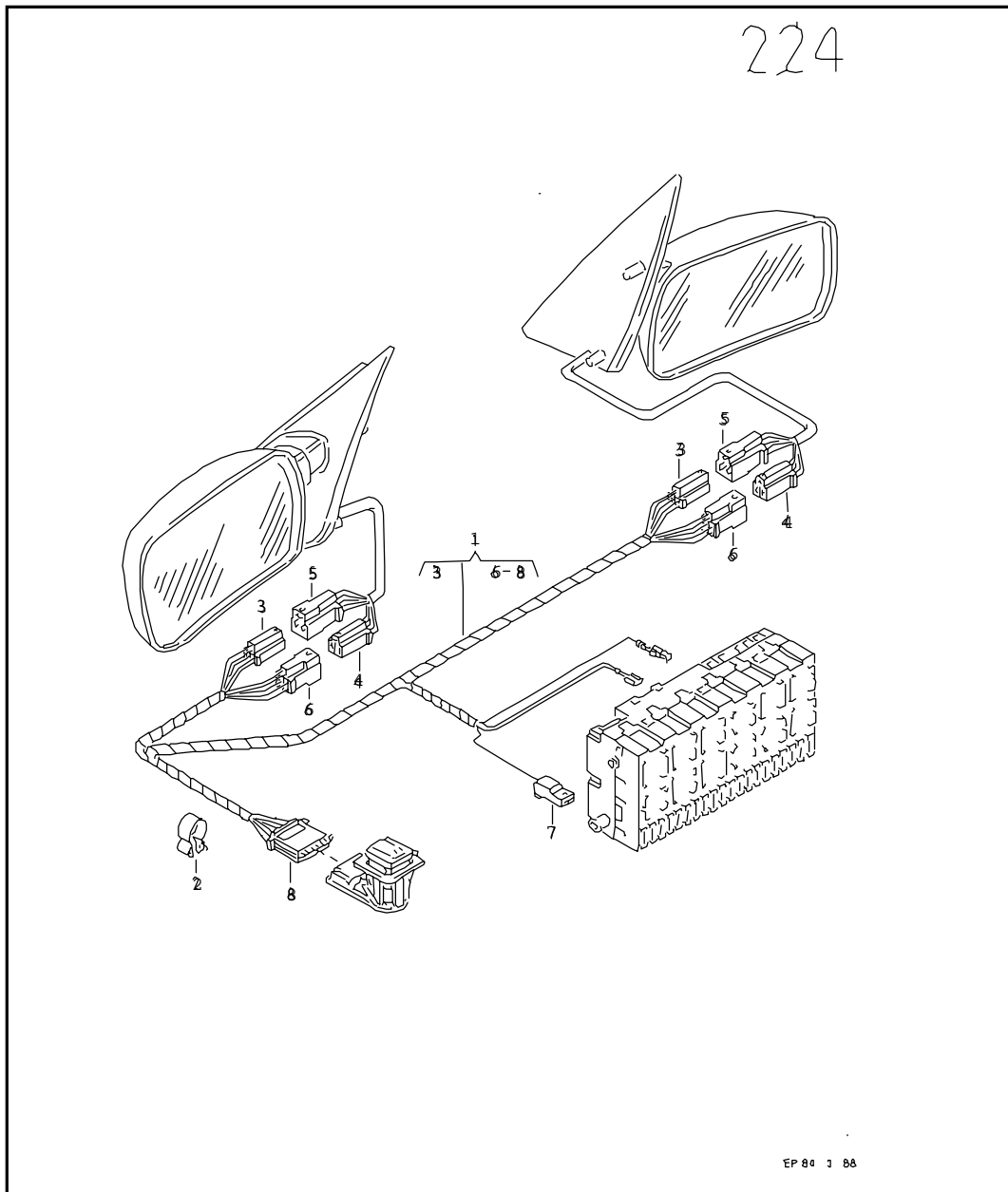

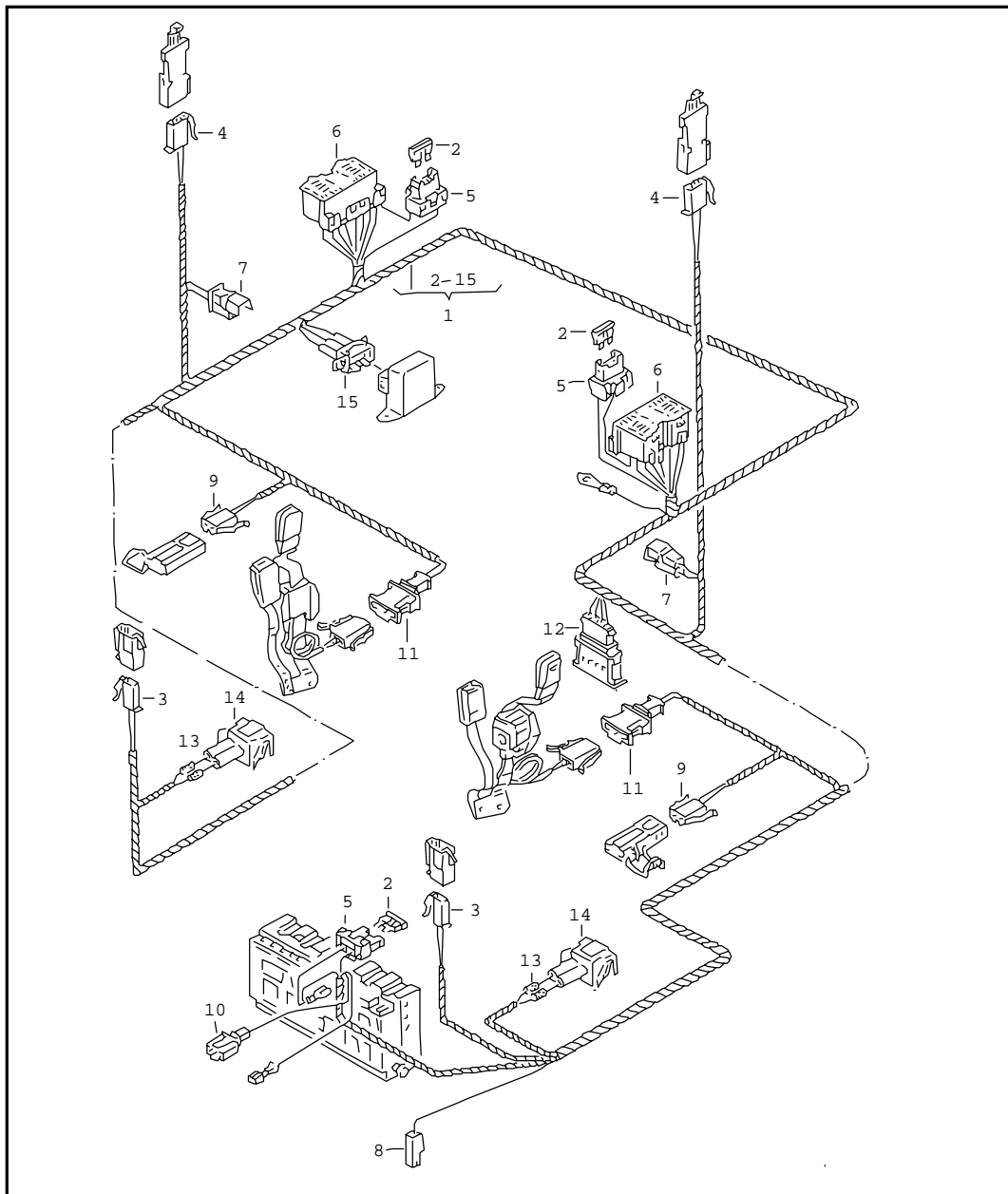

Pos	Part Number	Name	Remarks	Qty	Model
(1)	357 972 235 C	loom for rear view mirror		1	
		loom for rear view mirror	also use:		
			161 971 990 A	1	
			431 971 995	1	
(2)	N 902 055 01	cable binder	4,5X140	1	
3	161 971 970	terminal pin housing	3 pin	2	
4	161 971 970	terminal pin housing	3 pin	2	
5	161 971 975	flat connector housing	3 pin	2	
6	161 971 975	flat connector housing	3 pin	2	
7	161 971 990 A	terminal pin housing connecting piece loom, rear	1 pin		
		F >> 31-L-400 000		1	
8	321 971 998 A	spring contact housing	6 pin	1	
(10)	191 972 712	flat connector housing F 31-M-000 001>>	2 pin	1	
-	431 971 995	terminal pin housing ground connector F >> 31-L-400 000	1 pin	1	

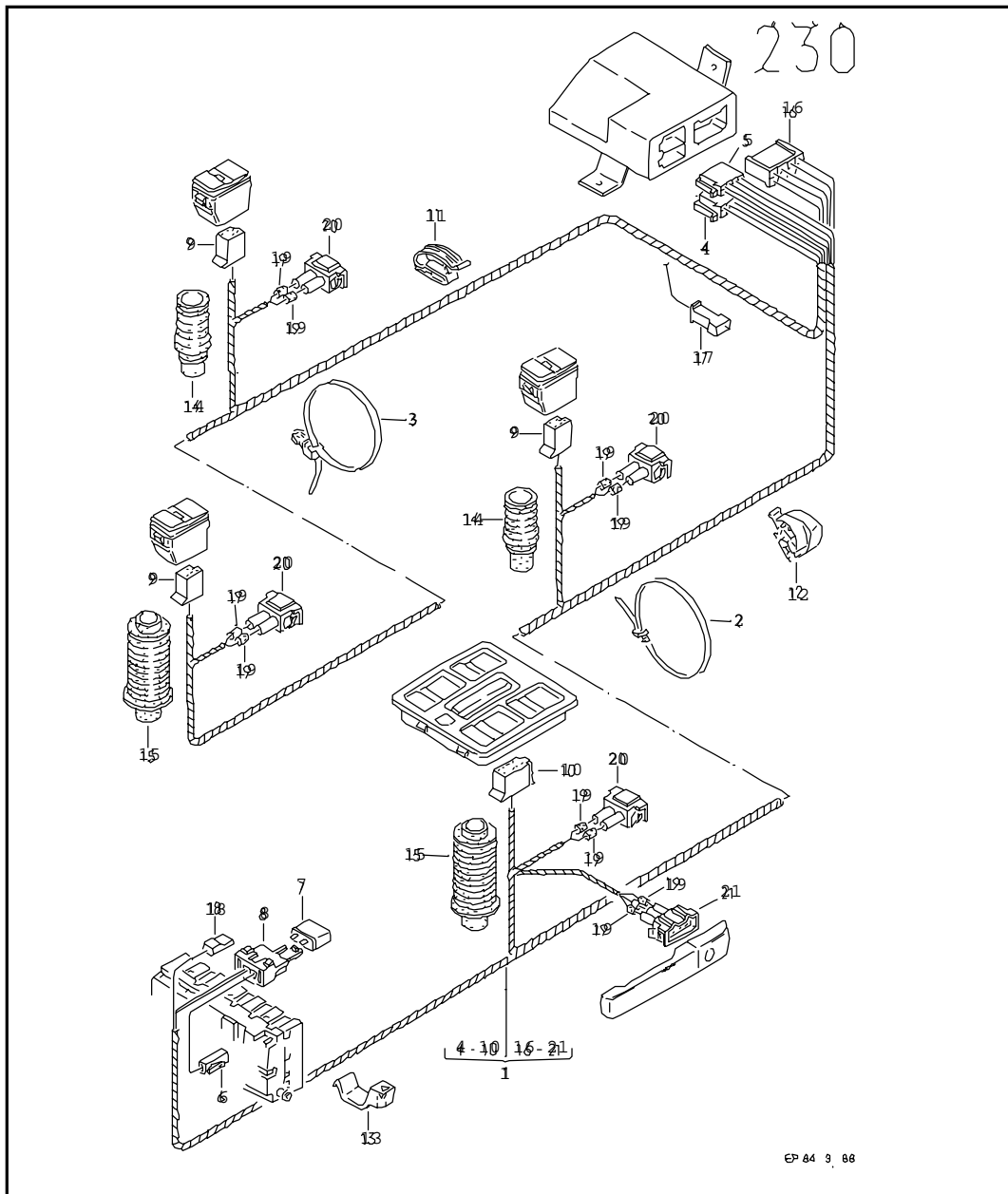

Pos	Part Number	Name	Remarks	Qty	Model
(1)	357 971 627 C	loom for passive restraint system			
2	N 017 131 5	flat fuse 19/2x5	10-red	3	
3	191 906 231 A	flat contact housing	2 pin	2	
4	191 906 231 B	flat contact housing	3 pin	2	
5	161 937 501	fuse box for flat fuses	2 pin	3	
6	357 937 501	relay plate	18 pin	2	
7	171 971 934	terminal pin housing	2 pin	2	
8	431 971 995	terminal pin housing	1 pin	1	
-	191 972 701	terminal pin housing F 31-M-000 001>>	1 pin	1	
9	191 972 702	flat contact housing	2 pin	2	
10	191 972 711	flat connector housing	1 pin	1	
11	191 972 712	flat connector housing	2 pin	2	
12	191 972 714	flat connector housing	4 pin	1	
13	357 972 741 A	single wiring seal	5,6X7,8 red for wire cross section: 1,5	4	
14	357 972 752	flat contact housing	2 pin	2	
15	357 972 753	flat contact housing	3 pin	1	





Pos	Part Number	Name	Remarks	Qty	Model
		loom for window lifter F >> 31-L-400 000			
(1)	357 971 160 H	loom for window lifter	front	1	
(1)	357 971 160 J	loom for window lifter for vehicles with central locking system	front	1	
(1)	357 971 160 K	loom for window lifter	front/rear lhd	1	
(1)	357 971 160 L	loom for window lifter for vehicles with central locking system	front/rear lhd	1	
(1)	358 971 160 B	loom for window lifter	front/rear rhd	1	
(1)	358 971 160 C	loom for window lifter for vehicles with central locking system	front/rear rhd	1	
		loom for window lifter F 31-M-000 001>>			
		----- see list of locally- made looms -----	see no.: 1		
(1)	357 971 160 R	loom for window lifter	front lhd	1	
(1)	357 971 160 S	loom for window lifter for vehicles with central locking system	front lhd	1	
(1)	357 971 160 P	loom for window lifter	front/rear lhd	1	
(1)	357 971 160 Q	loom for window lifter for vehicles with central locking system	front/rear lhd	1	
(1)	357 971 160 Q	loom for window lifter for vehicles with central locking system	front/rear lhd	1	
(1)	358 971 160 M	loom for window lifter	front rhd	1	
(1)	358 971 160 N	loom for window lifter for vehicles with central locking system	front rhd	1	

Model	Year	MG	SG	Illustration	VIN No.	Update	17:47	18.02.20100		ETKA	
PA	90	9	71	230-00		336					

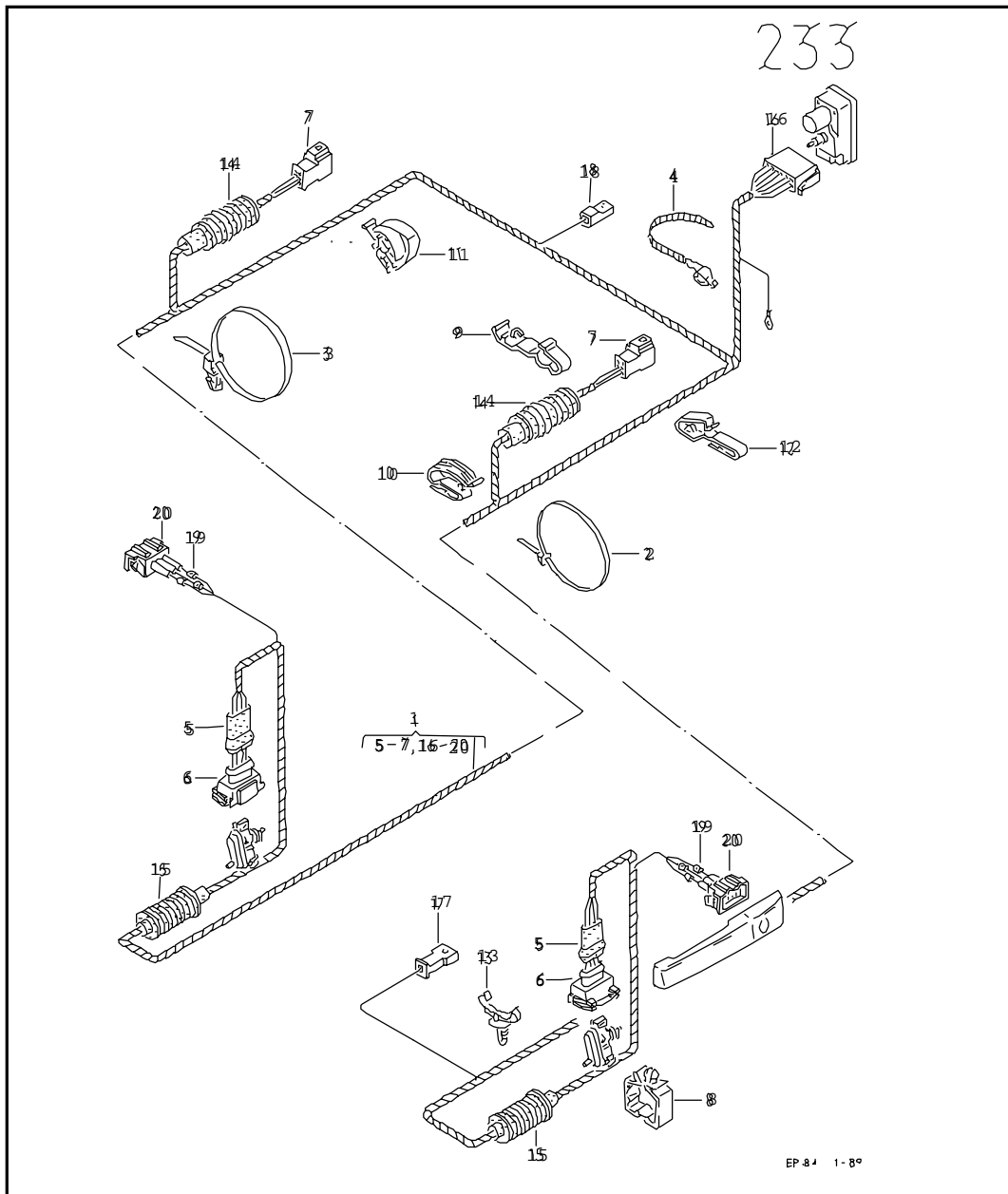

Pos	Part Number	Name	Remarks	Qty	Model	Pos	Part Number	Name	Remarks	Qty	Model
(1)	358 971 160 F	loom for window lifter	front/rear rhd	1		14	357 971 916 A	bellows	33,5X38,5	2	
(1)	358 971 160 G	loom for window lifter for vehicles with central locking system	front/rear rhd	1		15	357 971 916 C	bellows	60,5/43/48,5	2	
		single parts				16	811 971 971	flat contact housing	8 pin	1	
2	N 020 902 2	cable binder	6X246	2		17	161 971 976 A	flat connector housing connecting piece loom for centralized locking F >> 31-L-400 000	1 pin	1	
3	N 900 603 01	cable binder	6,5X175	2		(17)	191 972 711	flat connector housing connecting piece loom for centralized locking F 31-M-000 001>>	1 pin	1	
4	357 035 447	flat contact housing	8 pin black	1		18	431 971 995	terminal pin housing	1 pin	1	
5	357 035 447 A	flat contact housing	8 pin brown	1		-	191 972 734	flat contact housing F 31-M-000 001>> connecting piece loom for window lifter	rear	1	
6	357 907 971 B	terminal pin housing connector location:	1 pin U2,Y	1		19	357 972 741 A	single wiring seal for wire cross section: for vehicles without central locking for vehicles with central locking system	5,6X7,8 red 1,5	9	
7	443 937 105	thermo switch	20A	1						6	
8	191 937 501	bracket for thermo switch		1		20	357 972 752	flat contact housing engine	2 pin	4	
9	357 959 869	terminal pin housing F >> 31-L-400 000 window lifter	5 pin front front/rear	1 3		21	357 972 753	flat contact housing	3 pin	1	
		F 31-M-000 001>> window lifter	front/rear	2							
(9)	191 972 723	terminal pin housing F 31-M-000 001>>	6 pin	1							
(10)	357 959 869	terminal pin housing window lifter F >> 31-L-400 000	5 pin front	1							
10	357 959 869 A	flat contact housing window lifter F >> 31-L-400 000	10 pin front/rear	1							
(10)	191 972 723	terminal pin housing F 31-M-000 001>>	6 pin	1							
11	321 971 897	clip		X							
(12)	357 972 851 A	cable holder		X							
13	191 971 898 C	clip	4,8	1							
-	357 971 905 C	plug	51	2							



Pos	Part Number	Name	Remarks	Qty	Model
		loom for centralized locking		1	
		----- see list of locally-made looms -----	see no.: 1		
(1)	333 971 122 B	loom for centralized locking	lhd	1	
(1)	334 971 122 B	loom for centralized locking for vehicles with anti-theft alarm system	rhd	1	
-	357 971 801	cap pillar b	left	1	
-	357 971 802	cap pillar b	right	1	
2	N 020 902 2	cable binder	6X246	X	
3	N 900 603 01	cable binder	6,5X175	X	
4	N 904 288 01	cable binder with bracket for welded pin:	10X185 5	X	
5	191 906 102	protective cap terminal pin housing	5 pin	2	
(6)	4A0 906 234	flat contact housing	4 pin	2	
7	333 941 973	flat contact housing with helper contact catch connecting piece loom for centralized locking door	6 pin rear left/right	2	
8	867 971 848	clip	6,5	X	
9	357 971 854	cable holder		4	
10	321 971 897	clip		X	
(11)	357 972 851 A	cable holder		X	
12	357 971 897 A	cable holder		X	
(13)	357 971 899 B	bracket flat contact housing		X	
14	357 971 916 A	bellows	33,5X38,5	2	



Model	Year	MG	SG	Illustration	VIN No.	Update	17:47	18.02.20100		ETKA	
PA	90	9	71	233-00		336					

Pos	Part Number	Name	Remarks	Qty	Model	Pos	Part Number	Name	Remarks	Qty	Model
15	357 971 916 C	bellows	60,5/43/48,5	2							
16	357 971 967 A	flat contact housing with helper contact catch	12 pin	1							
17	161 971 976 A	flat connector housing connecting piece loom, rear F >> F31 L400 000	1 pin	1							
(17)	191 972 712	flat connector housing connecting piece loom, rear F 31-M-000 001>>	2 pin	1							
18	161 971 990 A	terminal pin housing connecting piece loom for window lifter F >> 31-L-400 000	1 pin	1							
(18)	191 972 701	terminal pin housing connecting piece loom for window lifter F 31-M-000 001>>	1 pin	1							
19	357 972 741 A	single wiring seal for wire cross section:	5,6X7,8 red 1,5	6							
20	357 972 753	flat contact housing	3 pin	2							

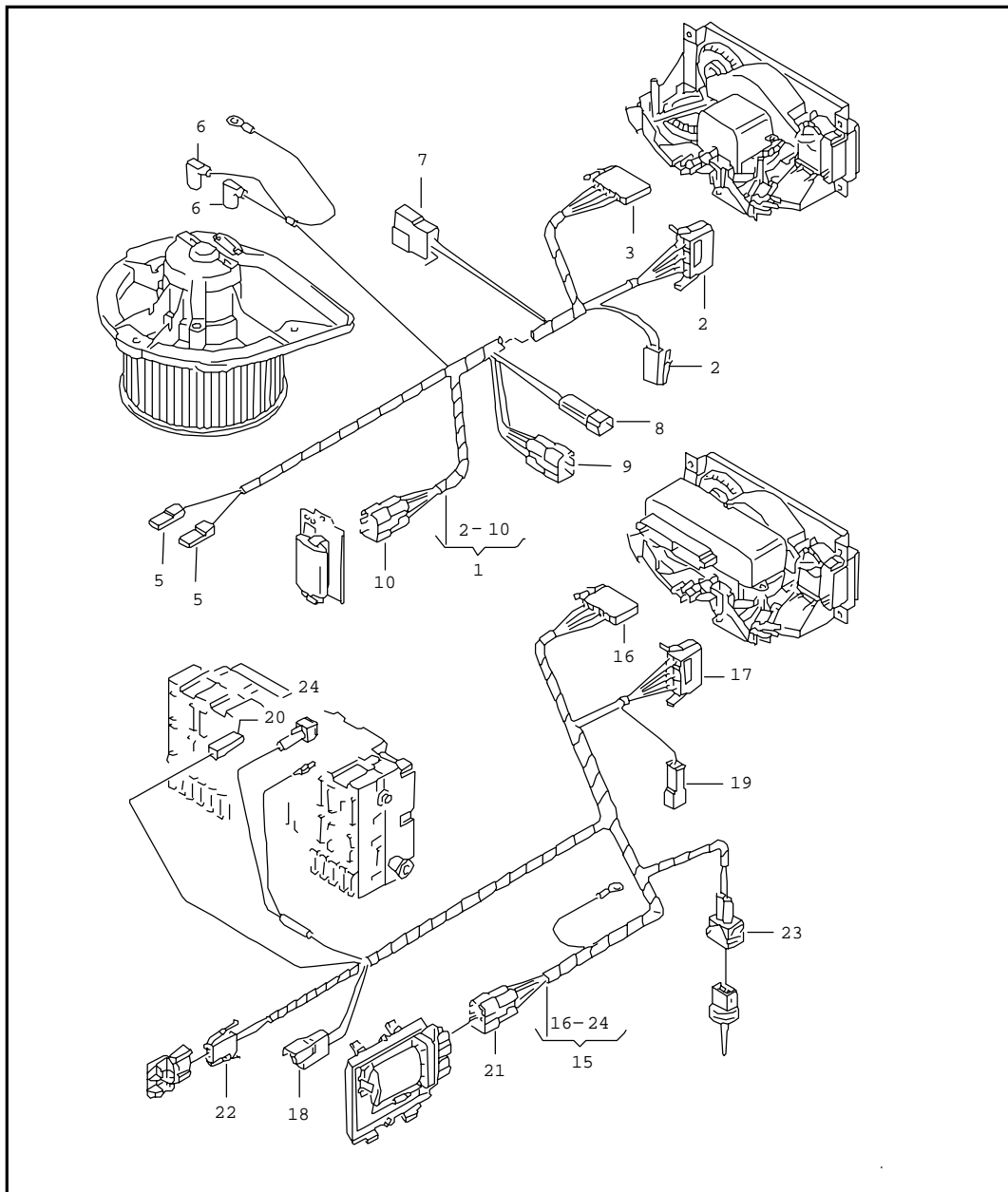
Model	Year	MG	SG	Illustration	VIN No.	Update	17:48	18.02.20100		ETKA	
PA	90	9	71	236-00		336					





Pos	Part Number	Name	Remarks	Qty	Model
		loom for fan			
		----- see list of locally-made looms -----	see no.: 14		
1	357 971 282 A	loom for fan switch for vehicles with air condit.			
2	191 906 231 A	flat contact housing	2 pin	1	
3	191 906 231 E	flat contact housing	6 pin	1	
4	357 959 545	terminal pin housing	6 pin	1	
5	111 971 921 B	terminal pin housing thermostat	1 pin	2	
6	211 971 921	angled connector	1 pin	2	
7	161 971 988 C	flat connector housing connecting piece loom for dashboard	2 pin	1	
8	171 971 998 A	round connector housing connecting piece loom for air conditioner	2 pin	1	
9	533 972 524	round connector housing connecting piece loom for air conditioner	5 pin	1	
10	533 972 524	round connector housing	5 pin	1	
		loom for fan switch for vehicles with electroni- cally regulated heater			
		----- see list of locally-made looms -----	see no.: 18		

Model	Year	MG	SG	Illustration	VIN No.	Update	17:48	18.02.20100		ETKA	
PA	90	9	71	236-00		336					

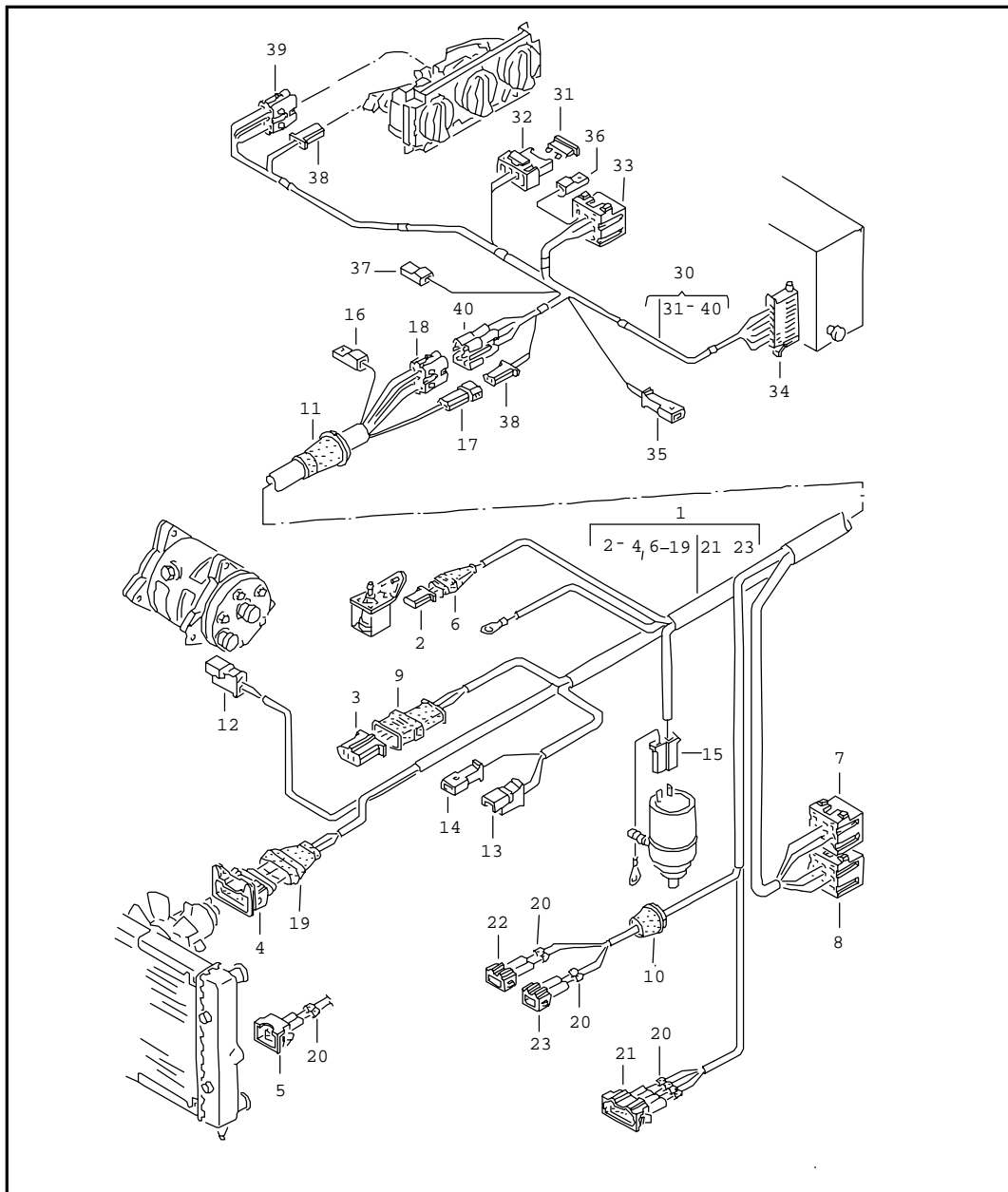

Pos	Part Number	Name	Remarks	Qty	Model	Pos	Part Number	Name	Remarks	Qty	Model
15	357 971 285	loom for fan switch									
		as required use:	191 972 761	1							
		F >> 31-L-400 000		1							
(15)	357 971 285 B	loom for fan switch									
		also use:	191 972 711	1							
		for vehicles with engine residual heat heater									
		F 31-M-000 001>>		1							
16	191 906 231 E	flat contact housing	6 pin								
		F >> 31-L-400 000		1							
(16)	191 972 706	flat contact housing	6 pin								
		F 31-M-000 001>>		1							
17	357 959 545	terminal pin housing	6 pin								
				1							
18	171 971 934	terminal pin housing connecting piece	2 pin								
		loom inner									
		temperature sensor		1							
		F >> 31-L-400 000									
19	161 971 976 A	flat connector housing connecting piece	1 pin								
		wiring harness for cigarette lighter									
		F >> 31-L-400 000		1							
19	357 972 761	flat contact housing connecting piece	1 pin								
		wiring harness for cigarette lighter									
		F >> 31-L-400 000		1							
20	431 971 995	terminal pin housing ground connector	1 pin								
				1							
21	533 972 524	round connector housing	5 pin								
				1							
22	191 972 702	flat contact housing	2 pin								
		F >> 31-L-400 000		1							
(22)	191 972 722	terminal pin housing	4 pin								
		F 31-M-000 001>>		1							
23	357 972 752	flat contact housing	2 pin								
				1							
(24)	191 972 711	flat connector housing	1 pin								
		F 31-M-000 001>>		1							
24	357 972 761	flat contact housing	1 pin								
		F >> 31-L-400 000		1							



Pos	Part Number	Name	Remarks	Qty	Model
		loom for air conditioner			
1	357 971 565 C	loom for air conditioner as required use: ** see current flow diagram ** F >> 31-K-400 000	357 972 761 lhd	1 1	
(1)	357 971 565 S	loom for air conditioner as required use: ** see current flow diagram ** F 31-L-000 001>> 31-L-400 000	357 972 761	1	
(1)	357 971 565 CJ	loom for air conditioner F 31-M-000 001>>	lhd also use: 161 971 989 C	1 1	
(1)	357 971 565 BG	loom for air conditioner	lhd	1	AAA
(1)	357 971 565 D	loom for air conditioner F >> 31-K-400 000	lhd	1	diesel eng.
(1)	357 971 565 T	loom for air conditioner F 31-L-000 001>> 31-L-400 000	lhd	1	diesel eng.
(1)	357 971 565 CK	loom for air conditioner F 31-M-000 001>>	also use: 161 971 989 C lhd	1 1	diesel eng.: 1Y
(1)	357 971 565 BH	loom for air conditioner F 31-M-000 001>>	lhd	1	diesel eng.: SB,AAZ
(1)	358 971 565 AL	loom for air conditioner as required use: F 31-L-000 001>> 31-L-400 000	357 972 761 rhd	1 1	
(1)	358 971 565 BH	loom for air conditioner F 31-M-000 001>>	rhd	1	
(1)	358 971 565 C	loom for air conditioner as required use: ** see current flow diagram ** F >> 31-K-400 000	357 972 761 rhd	1 1	
(1)	358 971 565 D	loom for air conditioner F >> 31-K-400 000	rhd	1	diesel eng.
(1)	358 971 565 AM	loom for air conditioner F 31-L-000 001>> 31-L-400 000	rhd	1	diesel eng.
2	443 906 231	terminal pin housing	2 pin	1	
(3)	893 906 231	terminal pin housing thermo switch	3 pin	1	

Model	Year	MG	SG	Illustration	VIN No.	Update	17:48	18.02.20100		ETKA	
PA	90	9	71	237-00		336					



Pos	Part Number	Name	Remarks	Qty	Model	Pos	Part Number	Name	Remarks	Qty	Model
4	191 906 232 B	terminal pin housing F >> 31-L-400 000	3 pin	1		17	171 971 998 A	round connector housing	2 pin	1	
(4)	1H0 906 233	flat contact housing F 31-M-000 001>>	3 pin	1		18	533 972 523	rd. connector sleeve housing	5 pin	1	
5	037 906 240	flat contact housing F 31-L-000 001>> 31-L-400 000 F 31-M-000 001>>	2 pin	1 2	diesel eng. diesel eng.	(19)	191 927 907	protective cap	16X25	1	
6	447 919 141	protective cap terminal pin housing	2 pin	1		20	357 972 741 A	single wiring seal for wire cross section:	5,6X7,8 red 1,5	X	
7	161 937 501 B	relay plate refrigerant compressor	9 pin	1		21	357 972 754	flat contact housing pressure switch	4 pin	1	
8	161 937 501 B	relay plate relay	9 pin 15BAR	1		(22)	357 972 761	flat contact housing connecting piece loom, left, front F >> 31-K-400 000	1 pin	1	
(8)	161 937 501 B	relay plate relay idling stabilisation	9 pin	1		22	357 972 762	flat connector housing connecting piece loom, left, front F 31-L-400 000>>	2 pin	1	
(9)	867 972 525 B	grommet thermo switch	26X13 3 pin	1		22	357 972 762	flat connector housing connecting piece loom, left, front F 31-L-400 000>>	2 pin	1	
-	803 971 892	grommet	3X25	X		(22)	191 972 702	flat contact housing F 31-M-000 001>>	2 pin	1	
10	311 971 907	grommet	23,5/4	1		23	357 972 762	flat connector housing temperature sensor	2 pin outer	1	
11	323 971 919	grommet	28/11	1				loom for air conditioner operation			
12	171 971 934	terminal pin housing	2 pin	1		30	357 971 566	loom for air conditioner operation F >> 31-K-400 000		1	
13	171 971 934	terminal pin housing connecting piece loom, left, front F >> 31-K-400 000	2 pin	1		(30)	357 971 566 E	loom for air conditioner operation also use: >>31-L-400000 161 971 976 A		1 1	
(13)	357 972 783	flat connector housing F 31-L-000 001>>	3 pin	1		(30)	357 971 566 F	loom for air conditioner operation F 31-L-000 001>> also use: >>31-L-400000 161 971 976 A		1 1	16V
-	357 972 742 B	single wiring seal for wire cross section: F 31-L-000 001>>	9,0X7,8 red 2,5	X							
14	161 971 976 A	flat connector housing connecting piece loom, left, front F >> 31-K-400 000	1 pin	1							
15	161 971 989 C	terminal pin housing	2 pin	1							
16	161 971 990 A	terminal pin housing	1 pin	1							

Model	Year	MG	SG	Illustration	VIN No.	Update	17:48	18.02.20100		ETKA	
PA	90	9	71	237-00		336					

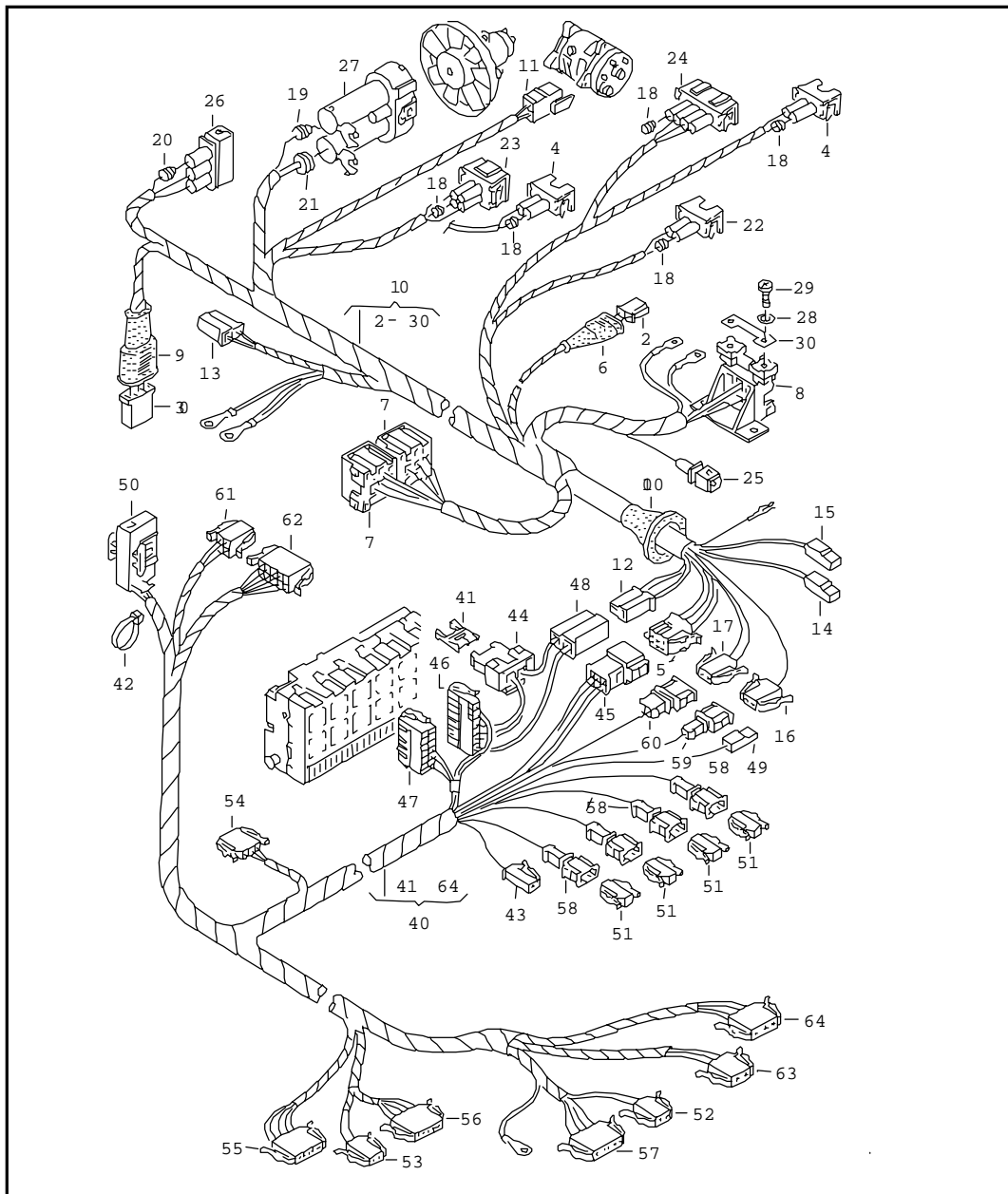

Pos	Part Number	Name	Remarks	Qty	Model	Pos	Part Number	Name	Remarks	Qty	Model
(30)	357 971 566 G	loom for air conditioner operation F 31-L-000 001>>		1	16V: automatic						
		also use: >>31-L-400000 161 971 976 A		1							
31	N 017 131 9	flat fuse 19/2x5	30-light green AMP	1							
32	161 937 501	fuse box for flat fuses	2 pin	1							
33	161 937 501 B	relay plate	9 pin	1							
(33)	161 937 501 B	relay plate retardation relay F 31-L-000 001>>	9 pin 2.0ltr.	1	16V						
34	357 959 968 B	flat contact housing with helper contact catch connector location: N	6 pin	1							
35	161 971 976 A	flat connector housing connecting piece wiring harness for cigarette lighter F >> 31-L-400 000	1 pin	1							
(35)	191 972 711	flat connector housing connecting piece wiring harness for cigarette lighter F 31-M-000 001>>	1 pin	1							
36	161 971 990 A	terminal pin housing	1 pin	1							
37	431 971 995	terminal pin housing	1 pin	1							
38	171 971 999 A	rd. connector sleeve housing	2 pin	2							
39	533 972 523	rd. connector sleeve housing	5 pin	1							
40	533 972 524	round connector housing	5 pin	1							
-	191 972 702	flat contact housing connecting piece loom, left, front F 31-M-000 001>>	2 pin	1							





Pos	Part Number	Name	Remarks	Qty	Model
		loom for electronically regulated air conditioner			
(1)	357 971 565 BC	loom for electronically regulated air conditioner	lhd	1	
(1)	357 971 565 BP	loom for electronically regulated air conditioner	lhd	1	AAA
1	357 971 565 BR	loom for electronically regulated air conditioner	lhd	1	AAZ
(1)	358 971 565 BK	loom for electronically regulated air conditioner	rhd	1	
2	443 906 231	terminal pin housing heater pipe	2 pin	1	
(3)	893 906 231	terminal pin housing thermo switch	3 pin	1	
4	037 906 240	flat contact housing temperature sensor engine	2 pin	1	AAA
5	357 907 968 A	flat contact housing	6 pin	1	
6	447 919 141	protective cap		1	AAZ
7	161 937 501 B	relay plate	9 pin	2	
8	251 937 501 B	relay plate	9 pin	1	
(9)	867 972 525 B	grommet	26X13	1	
10	323 971 919	grommet	28/11	1	
11	171 971 934	terminal pin housing	2 pin	1	
12	161 971 989 C	terminal pin housing	2 pin	1	
13	161 971 989 C	terminal pin housing headlight washer system	2 pin pump	1	
14	161 971 990 A	terminal pin housing connecting piece loom for headlamp washer system	1 pin	1	
15	431 971 995	terminal pin housing clip	1 pin 31	X	
16	191 972 702	flat contact housing connecting piece wiring loom for engine	2 pin	1	

Model	Year	MG	SG	Illustration	VIN No.	Update	17:48	18.02.20100		ETKA	
PA	90	9	71	237-50		336					

Pos	Part Number	Name	Remarks	Qty	Model	Pos	Part Number	Name	Remarks	Qty	Model
17	191 972 702	flat contact housing	2 pin	1		42	N 020 902 2	cable binder	6X246	1	
18	357 972 741	single wiring seal	5,6X7,8 blue for wire cross section: 1,0	X		43	701 906 231	flat contact housing junction box	2.8MM	1	
19	357 972 741 B	single wiring seal	5,6X7,8 yellow orange for wire cross section: 2,5	X		44	161 937 501	fuse box for flat fuses	2 pin	1	
20	357 972 742 B	single wiring seal	9,0X7,8 red for wire cross section: 2,5	X		45	333 941 973	flat contact housing with helper contact catch	6 pin	1	
21	357 972 744	single wiring seal	16,2X15,0 orange for wire cross section: 4,0	X		46	357 959 968 B	flat contact housing with helper contact catch connector location: N	6 pin	1	
22	357 972 752	flat contact housing temperature sensor	2 pin outer	1		47	357 971 968 B	flat contact housing with helper contact catch connector location: D	12 pin	1	
23	357 972 754	flat contact housing high pressure switch	4 pin	1		48	161 971 988 C	flat connector housing	2 pin	1	
24	357 972 754	flat contact housing temperature sensor engine	4 pin	1		49	431 971 995	terminal pin housing ground connector	1 pin	1	
25	357 972 761	flat contact housing	1 pin	1		50	357 972 529	terminal pin housing	28 pin	1	
26	357 972 783	flat connector housing connecting piece loom, left, front	3 pin	1		51	191 972 701	terminal pin housing	1 pin	4	
26	357 972 783	flat connector housing connecting piece loom, left, front	3 pin	1		52	191 972 702	flat contact housing temperature sensor intake manifold	2 pin	1	
27	1H0 973 204	flat contact housing	4 pin	1		53	191 972 702	flat contact housing thermostat	2 pin	1	
28	N 012 225 3	spring washer	B5X11X0,5	2		54	191 972 703	flat contact housing photo sensor	3 pin	1	
29	N 014 128 11	fillister hd. screw	M5X8	2		55	191 972 705	terminal pin housing solenoid valve	5 pin	1	
30	N 017 125 1	fuse	B50	1		56	191 972 705	terminal pin housing flap for evaporator housing	5 pin	1	
		loom for air conditioner operation				57	191 972 705	terminal pin housing valve	5 pin	1	
40	357 971 566 C	loom for air conditioner operation		1		58	191 972 711	flat connector housing	1 pin	4	
41	N 017 131 9	flat fuse	19/2x5 30-light green AMP	1		59	191 972 711	flat connector housing connecting piece loom for 4 speed automatic gearbox	1 pin	1	
						60	191 972 712	flat connector housing	2 pin	1	



Model	Year	MG	SG	Illustration	VIN No.	Update	17:48	18.02.20100		ETKA	
PA	90	9	71	237-50		336					

Pos	Part Number	Name	Remarks	Qty	Model	Pos	Part Number	Name	Remarks	Qty	Model
61	191 972 722	terminal pin housing temperature sensor	4 pin inner	1							
62	191 972 725	terminal pin housing	10 pin	1							
63	191 972 752	flat contact housing fan	2 pin inner	1							
64	191 972 753	flat contact housing fan	3 pin	1							

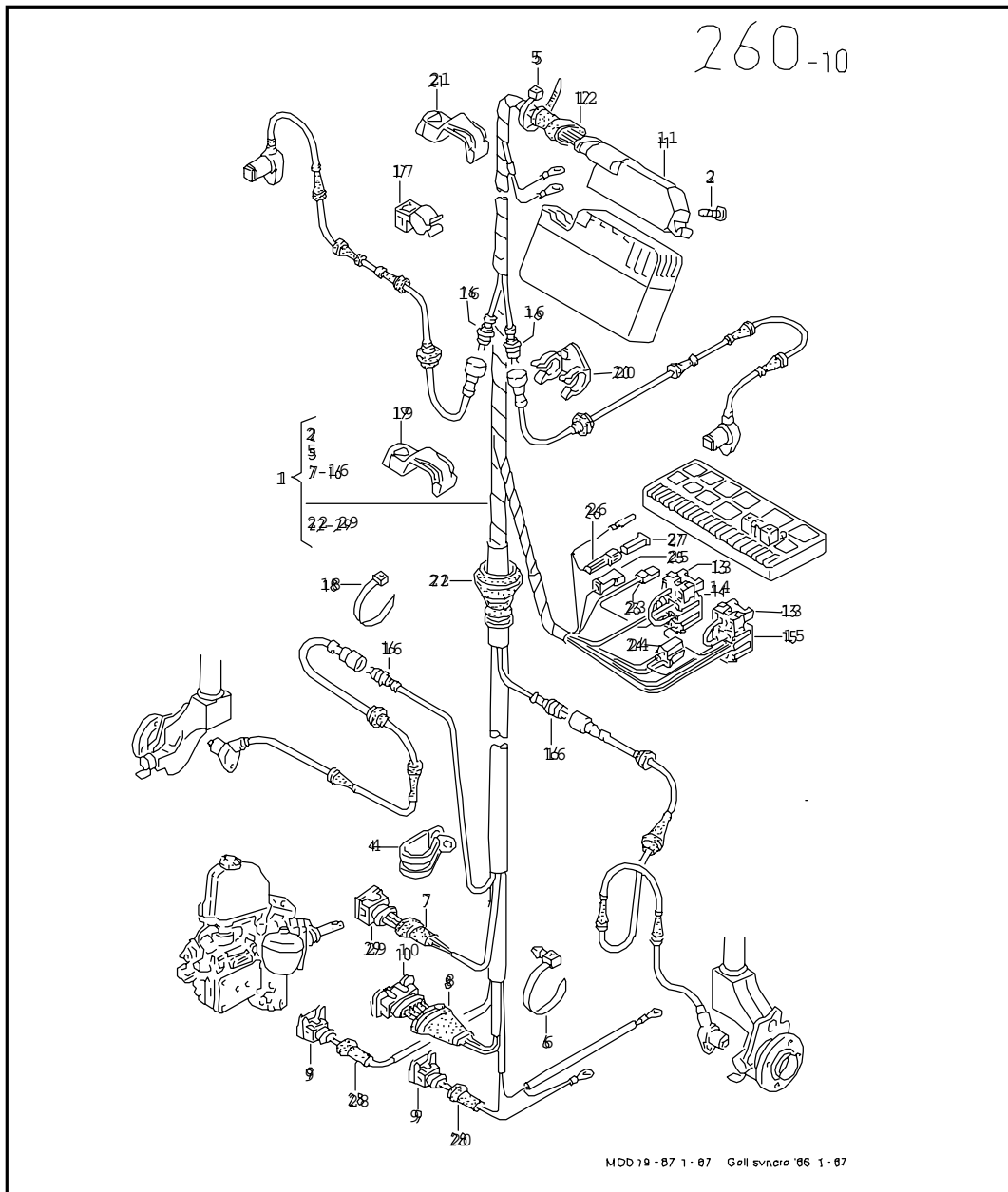

Model	Year	MG	SG	Illustration	VIN No.	Update	17:49	18.02.20100		ETKA	
PA	90	9	71	239-00		336					



Pos	Part Number	Name	Remarks	Qty	Model
(1)	357 971 279 D	loom for anti locking brake system -abs-			
		loom for anti locking brake system -abs- F >> 31-MB166 000* lhd 1 F >> 31-ME190 000* lhd 1 as required use: 357 972 751 1 357 972 761 1			
(1)	357 971 279 F	loom for anti locking brake system -abs- F 31-MB166 001>>* lhd 1 F 31-ME190 001>>* lhd 1			
(1)	357 971 279 E	loom for anti locking brake system with electronic differential lock -abs/eds- as required use: >>31-LE152500 >>31-LB049668 161 971 976 A 1 161 971 9900 A 1 as required use: 31-LE152501>> 31-LB049668>> 191 972 751 1 191 972 761 1 F >> 31-L-400 000 lhd 1			
(1)	357 971 279 E	loom for anti locking brake system with electronic differential lock -abs/eds- F 31-MB000 001>> 31-M-166 000* lhd 1 F 31-ME000 001>> 31-ME190 000* lhd 1			
(1)	357 971 279 G	loom for anti locking brake system with electronic differential lock -abs/eds- F 31-MB166 001>>* lhd 1 F 31-ME190 001>>* lhd 1			
(1)	358 971 279	loom for anti locking brake system -abs-			rhd 1
2	N 013 953 2	tapping screw, fill. hd.	B2,9X9,5	1	



Model	Year	MG	SG	Illustration	VIN No.	Update	17:49	18.02.20100		ETKA	
PA	90	9	71	239-00		336					

Pos	Part Number	Name	Remarks	Qty	Model	Pos	Part Number	Name	Remarks	Qty	Model
-	N 017 131 9	flat fuse 19/2x5	30-light green AMP	2		-	893 945 521	protective cap for vehicles with electronic differential lock -edl-	28X10,7	1	
(5)	N 020 902 2	cable binder	6X246	X		(19)	357 971 005	cable holder		6	
(6)	N 902 055 01	cable binder	4,5X140	3		(20)	811 971 848 E	cable holder	6,5X14,5X20,5	1	
7	191 906 102	protective cap terminal pin housing	5 pin	1		(22)	357 971 905 E	grommet	46/16	1	
(7)	443 906 102 B	grommet	18X20,5	1		23	161 971 990 A	terminal pin housing	1 pin	2	
(8)	037 906 102 A	protective cap		1		(24)	357 907 968 A	flat contact housing connector location: W	6 pin	1	
-	025 906 235 B	flat contact housing valve unit	5 pin	1		25	161 971 976 A	flat connector housing	1 pin	1	
-	357 972 755	flat contact housing valve unit for vehicles with electronic differential lock -edl-	5 pin	1		-	191 972 702	flat contact housing for vehicles with electronic differential lock -edl-	2 pin	1	
(9)	037 906 240	flat contact housing	2 pin	2		-	443 972 577 E	flat contact housing	2 pin	1	
10	071 906 233	flat contact housing	7 pin	1		(26)	357 972 751 F	flat contact housing >> 31-L-400 000	1 pin	1	
(10)	071 906 233 A	flat contact housing for vehicles with electronic differential lock -edl-	7 pin	1		(26)	191 972 701	terminal pin housing F 31-M-000 001>>	1 pin	1	
(10)	357 973 215	flat contact housing	15 pin	1	rhd	-	357 972 752	flat contact housing	2 pin	1	rhd
11	022 906 239	cap	black	1		(27)	357 972 761 F	flat contact housing >> 31-L-400 000	1 pin	1	
(11)	191 906 370 A	flat contact housing with gasket	35 pin	1		(27)	191 972 711	flat connector housing F 31-M-000 001>>	1 pin	1	
(11)	357 907 495	flat contact housing for vehicles with electronic differential lock -edl-	55 pin	1		(28)	357 972 741 A	single wiring seal for wire cross section: red 1,5	5,6X7,8	X	
12	022 906 241	protective cap		1		(28)	357 972 742 C	single wiring seal for wire cross section: green 4,0	9,0X7,8	X	
13	161 937 501	fuse box for flat fuses	2 pin	2		(29)	191 906 232 A	flat contact housing	2 pin	1	
14	161 937 501 B	relay plate	9 pin	1		29	191 972 995	flat contact housing	5 pin	1	
15	867 937 501	relay plate		1		(29)	357 906 231	flat contact housing		1	rhd
16	191 971 413 A	wiring harness for speed sensor		4							
(18)	N 904 288 01	cable binder with bracket for welded pin:	10X185 5	1							

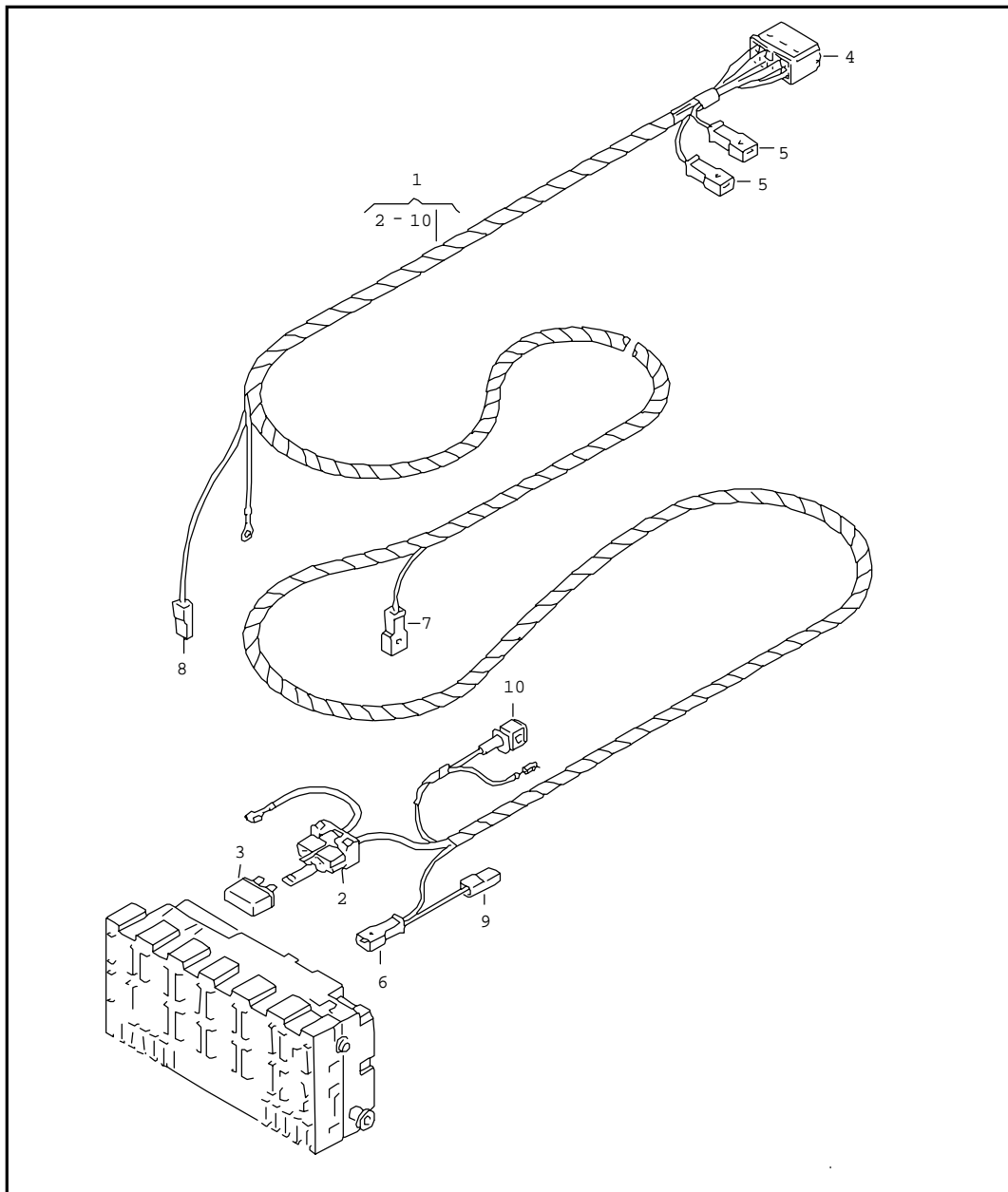

Model	Year	MG	SG	Illustration	VIN No.	Update	17:50	18.02.20100		ETKA	
PA	90	9	71	240-00		336					



Pos	Part Number	Name	Remarks	Qty	Model
1	358 971 553 A	loom self levelling system loom for self-levelling system	also use: F>>31-M-240000 161 971 976 A 161 971 990 A 357 972 761 also use: lhd ** see current flow diagram **	2 1 1 1	
2	443 937 105 A	thermo switch	30A	1	
3	191 937 501	bracket for thermo switch		1	
4	811 971 971	flat contact housing electronic control unit	8 pin	1	
5	161 971 976 A	flat connector housing	1 pin	2	
6	161 971 976 A	flat connector housing connecting piece loom, rear F >> 31-M-240 000*	1 pin	1	
7	161 971 976 A	flat connector housing connecting piece wiring harness for door contact switch F >> 31-M-240 000*	1 pin	1	
(7)	191 972 711	flat connector housing connecting piece wiring harness for door contact switch F 31-M-240 001>>*	1 pin	1	
8	161 971 990 A	terminal pin housing connecting piece loom for luggage compl. rear F >> 31-M-240 000*	1 pin	1	
(8)	191 972 701	terminal pin housing connecting piece loom for luggage compl. rear F 31-M-240 001>>*	1 pin	1	
9	161 971 990 A	terminal pin housing F >> 31-M-240 000*	1 pin	1	
-	191 972 701	terminal pin housing F 31-M-240 001>>*	1 pin	2	



Model	Year	MG	SG	Illustration	VIN No.	Update	17:50	18.02.20100		ETKA	
PA	90	9	71	240-00		336					

Pos	Part Number	Name	Remarks	Qty	Model	Pos	Part Number	Name	Remarks	Qty	Model
(10)	191 972 711	flat connector housing F 31-M-240 001>>*	1 pin	1							
(10)	357 972 761	flat contact housing F >> 31-M-240 000*	1 pin	1							

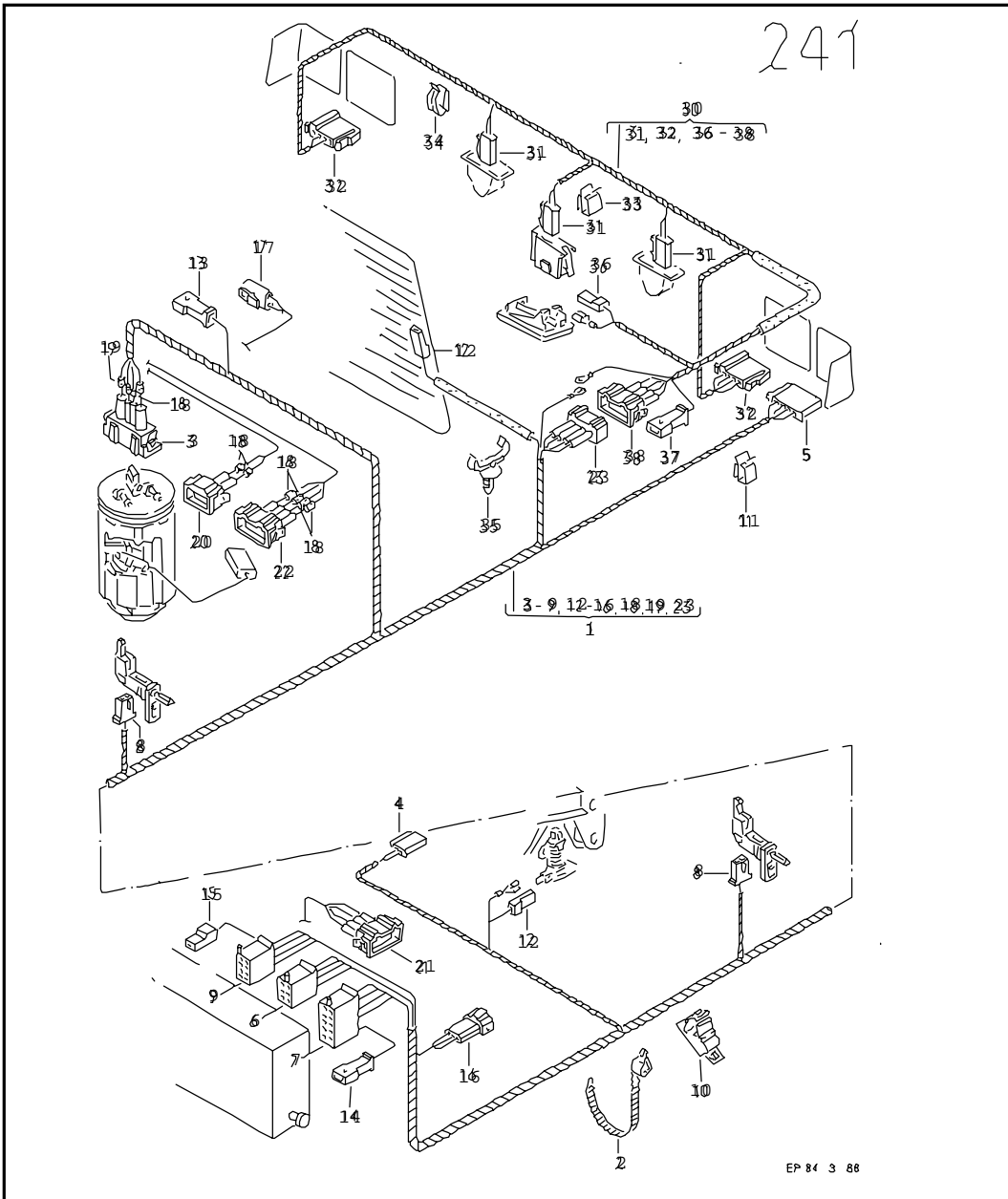

Model	Year	MG	SG	Illustration	VIN No.	Update	17:51	18.02.20100		ETKA	
PA	90	9	71	241-00		336					





Pos	Part Number	Name	Remarks	Qty	Model
		loom, rear F >> 31-L-400 000			notchback
(1)	357 971 011	loom, rear	lhd	1	diesel eng., carburetor engine
(1)	357 971 011 A	loom, rear	lhd	1	16V
(1)	357 971 011 E	loom, rear	lhd	1	DIGIFANT, MONO- JETRONIC
(1)	358 971 011	loom, rear	rhd	1	diesel eng., carburetor engine
(1)	358 971 011 A	loom, rear	rhd	1	16V
(1)	358 971 011 E	loom, rear	rhd	1	
(1)	358 971 011 F	loom, rear for vehicles with additional brake light	rhd	1	16V
		see list of locally- made looms			see no.: 4,15
		loom, rear F 31-M-000 001>>			notchback
(1)	357 971 011 R	loom, rear	lhd	1	diesel eng., carburetor engine
(1)	357 971 011 S	loom, rear	lhd	1	16V
(1)	357 971 011 AA	loom, rear	lhd	1	
	358 971 011 G	loom, rear	rhd	1	diesel eng., carburetor engine
(1)	358 971 011 N	loom, rear	rhd	1	16V
(1)	358 971 011 M	loom, rear	rhd	1	
		see list of locally- made looms			see no.: 4,15

Model	Year	MG	SG	Illustration	VIN No.	Update	17:51	18.02.20100		ETKA	
PA	90	9	71	241-00		336					

Pos	Part Number	Name	Remarks	Qty	Model	Pos	Part Number	Name	Remarks	Qty	Model
		single parts				(13)	191 972 711	flat connector housing connecting piece wiring harness for door contact switch F 31-M-000 001>>	1 pin	1	
2	N 904 288 01	cable binder with bracket for welded pin:	10X185 5	1		14	161 971 976 A	flat connector housing F >> 31-L-400 000	1 pin	1	
3	357 906 231	flat contact housing		1		(14)	191 972 702	flat contact housing F 31-M-000 001>>	2 pin	1	
4	191 906 231 A	flat contact housing ashtray light	2 pin	1		15	161 971 990 A	terminal pin housing F >> 31-L-400 000	1 pin	1	
5	191 906 231 E	flat contact housing	6 pin	1		(15)	191 972 702	flat contact housing F 31-M-000 001>>	2 pin	1	
6	357 906 968	flat contact housing with helper contact catch connector location:	6 pin M	1		-	191 972 701	terminal pin housing connecting piece loom for 4 speed automatic gearbox F 31-M-000 001>>	1 pin	1	
7	357 945 968	flat contact housing with helper contact catch connector location:	12 pin B	1		-	191 972 701	terminal pin housing connecting piece loom for 4 speed automatic gearbox F 31-M-000 001>>	1 pin	1	
8	357 947 231	flat contact housing	2 pin	2		16	171 971 998 B	round connector housing connecting piece loom for interior light F >> 31-L-400 000	3 pin	1	
9	357 947 968	flat contact housing with helper contact catch connector location:	8 pin L	1		(16)	191 972 732	terminal pin housing connecting piece loom for interior light F 31-M-000 001>>	4 pin	1	
(10)	357 971 005	cable holder		6		17	811 972 577	rd. connector sleeve housing fuel pump F >> 31-L-400 000	2 pin	1	16V
-	357 971 842 B	retaining clip for vehicles with additional brake light		X		(17)	191 972 752	flat contact housing fuel pump F 31-M-000 001>>	2 pin	1	16V
(11)	893 971 847 G	clip		X		-	443 972 580	flat contact housing for diagnosis plug F 31-M-000 001>>	2 pin	1	
(11)	321 971 897	clip for vehicles with trailers		X		18	357 972 741 A	single wiring seal for wire cross section:	5,6X7,8 red 1,5	X	
12	111 971 921 B	terminal pin housing hand brake lever	1 pin	1							
(12)	161 971 990 A	terminal pin housing rear window glass heated	1 pin	1							
13	161 971 976 A	flat connector housing connecting piece wiring harness for door contact switch F >> 31-L-400 000	1 pin	1							



Model	Year	MG	SG	Illustration	VIN No.	Update	17:51	18.02.20100		ETKA	
PA	90	9	71	241-00		336					

Pos	Part Number	Name	Remarks	Qty	Model	Pos	Part Number	Name	Remarks	Qty	Model
19	357 972 742 A	single wiring seal for wire cross section:	9,0X7,8 white 1,5	X		-	191 972 701	terminal pin housing for vehicles with self-levelling system F 31-M-000 001>>	1 pin	1	
20	357 972 752	flat contact housing	2 pin 1.6ltr.	1		-	191 972 702	flat contact housing for vehicles with self-levelling system F 31-M-000 001>>	2 pin	1	
22	357 972 754	flat contact housing	4 pin	1	16V						
23	357 972 764	flat connector housing F >> 31-L-400 000	4 pin	1		(37)	191 972 711	flat connector housing for vehicles with self-levelling system F 31-M-000 001>>	1 pin	1	
(23)	191 972 733	terminal pin housing F 31-M-000 001>>	6 pin	1		38	357 972 754	flat contact housing F >> 31-L-400 000	4 pin	1	
		loom for luggage compl. rear			notchback	(38)	191 972 733	terminal pin housing F 31-M-000 001>>	6 pin	1	
(30)	357 971 145 B	loom for luggage compl. rear F >> 31-L-400 000	lhd	1							
(30)	357 971 145 N	loom for luggage compl. rear also use: F 31-M-000 001>>	111 971 921 B	1 1							
(30)	358 971 145 B	loom for luggage compl. rear F >> 31-L-400 000	rhd	1							
(30)	357 971 145 N	loom for luggage compl. rear also use: F 31-M-000 001>>	111 971 921 B rhd	1 1							
31	191 906 231 A	flat contact housing	2 pin	3							
32	321 945 248	flat contact housing	3 pin	2							
(33)	893 971 847 G	clip		X							
34	321 971 897	clip		X							
(35)	357 971 899 G	bracket flat contact housing	4 pin	1							
36	111 971 921 B	terminal pin housing	1 pin	1							
37	161 971 976 A	flat connector housing for vehicles with self-levelling system F >> 31-L-400 000	1 pin	1							

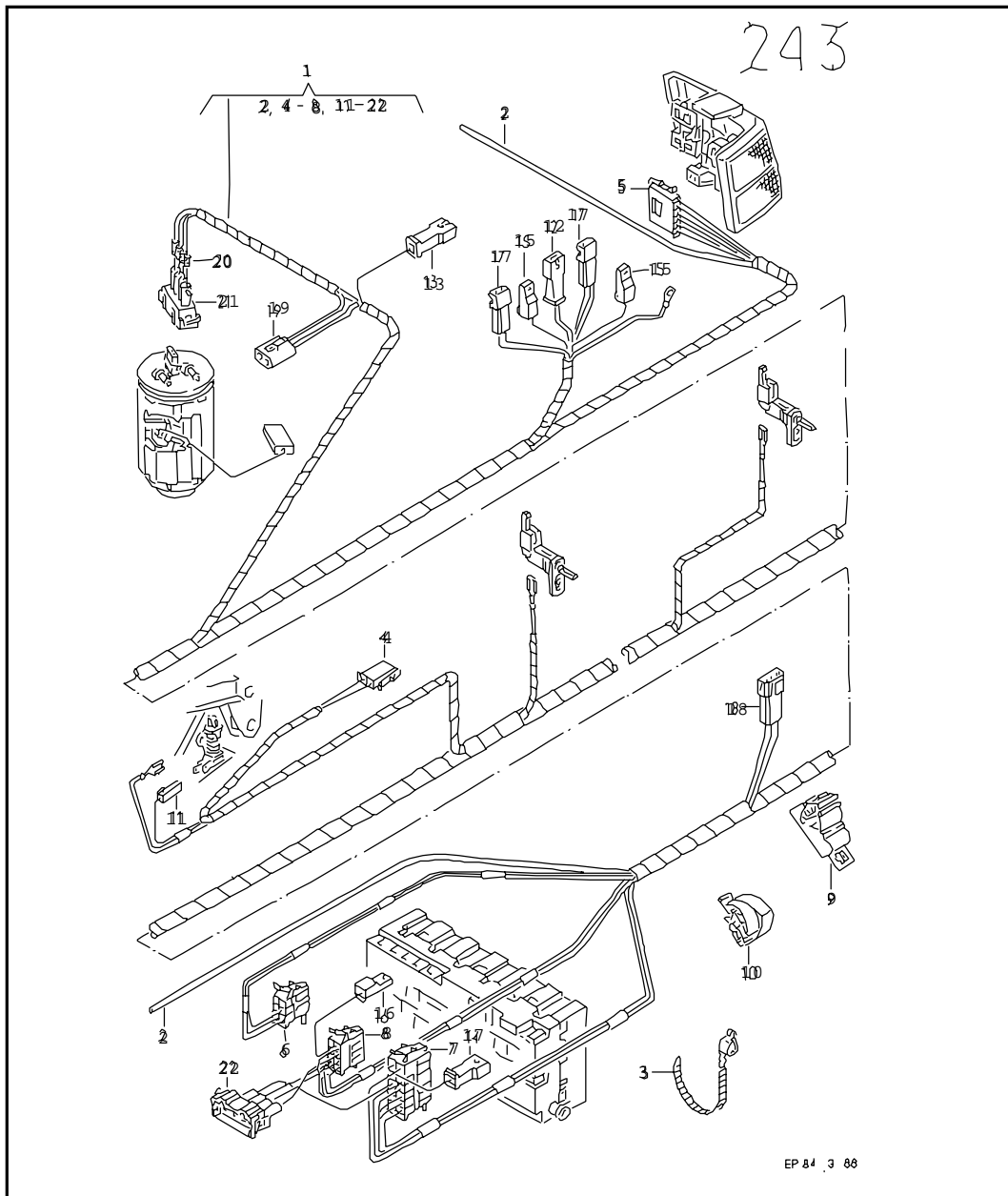

Model	Year	MG	SG	Illustration	VIN No.	Update	17:51	18.02.20100		ETKA	
PA	90	9	71	243-00		336					





Pos	Part Number	Name	Remarks	Qty	Model
		loom, rear F >> 31-L-400 000			squareback
(1)	333 971 011	loom, rear	lhd	1	diesel eng., carburetor engine
(1)	333 971 011 A	loom, rear	lhd	1	16V
(1)	333 971 011 E	loom, rear	lhd	1	
(1)	334 971 011	loom, rear	rhd	1	diesel eng., carburetor engine
(1)	334 971 011 A	loom, rear	rhd	1	
(1)	334 971 011 D	loom, rear	rhd	1	16V
		----- see list of locally- made looms -----	see no.: 4		
		loom, rear F 31-M-000 001>>			squareback
(1)	333 971 011 AM	loom, rear	lhd	1	diesel eng., carburetor engine
(1)	333 971 011 S	loom, rear	lhd	1	16V
(1)	333 971 011 AA	loom, rear	lhd	1	
(1)	334 971 011 E	loom, rear	rhd	1	diesel eng., carburetor engine
(1)	334 971 011 H	loom, rear	rhd	1	
(1)	334 971 011 J	loom, rear	rhd	1	16V
		----- see list of locally- made looms -----	see no.: 4		
		single parts			
2	867 955 961 A	tube	5X1X5600MM	1	

Model	Year	MG	SG	Illustration	VIN No.	Update	17:51	18.02.20100		ETKA	
PA	90	9	71	243-00		336					

Pos	Part Number	Name	Remarks	Qty	Model	Pos	Part Number	Name	Remarks	Qty	Model
3	N 904 288 01	cable binder with bracket for welded pin:	10X185 5	X		(16)	191 972 702	flat contact housing F 31-M-000 001>>	2 pin	1	
4	191 906 231 A	flat contact housing ashtray	2 pin	1		17	171 971 998 A	round connector housing connecting piece wiring harnessadapter flap, rear	2 pin	2	
5	191 906 231 E	flat contact housing	6 pin	1		18	171 971 998 B	round connector housing connecting piece loom for interior light F >> 31-L-400 000	3 pin	1	
6	357 906 968	flat contact housing with helper contact catch connector location:	6 pin M	1		(18)	191 972 732	terminal pin housing connecting piece wiring harnessadapter flap, rear F 31-M-000 001>>	4 pin	1	
7	357 945 968	flat contact housing with helper contact catch connector location:	12 pin B	1		19	811 972 577	rd. connector sleeve housing F >> 31-L-400 000	2 pin	1	16V
8	357 947 968	flat contact housing with helper contact catch connector location:	8 pin L	1		(19)	191 972 752	flat contact housing F 31-M-000 001>>	2 pin	1	16V
(9)	357 971 005	cable holder		6		-	443 972 580	flat contact housing for diagnosis plug F 31-M-000 001>>	2 pin	1	
(10)	357 972 851 A	cable holder		2		-	191 972 701	terminal pin housing connecting piece loom cassette holder F 31-M-000 001>>	1 pin	1	
11	111 971 921 B	terminal pin housing	1 pin	1		-	191 972 701	terminal pin housing additional brake light F 31-M-000 001>>	1 pin	1	
12	161 971 976 A	flat connector housing connecting piece wiring harnessadapter flap, rear	1 pin	1		20	357 972 741	single wiring seal for wire cross section: F >> 31-L-400 000 F >> 31-L-400 000	5,6X7,8 blue 1,0	2 4	16V
13	161 971 976 A	flat connector housing connecting piece wiring harness for door contact switch F >> 31-L-400 000	1 pin right	1		(20)	357 972 741 A	single wiring seal for wire cross section: F 31-M-000 001>> F 31-M-000 001>>	5,6X7,8 red 1,5	2 4	16V
(13)	191 972 711	flat connector housing connecting piece wiring harness for door contact switch F 31-M-000 001>>	1 pin	1		(20)	357 972 742 A	single wiring seal for wire cross section: 1,5	9,0X7,8 white 1,5	1	
14	161 971 976 A	flat connector housing F >> 31-L-400 000	1 pin	1							
(14)	191 972 702	flat contact housing F 31-M-000 001>>	2 pin	1							
15	161 971 990 A	terminal pin housing connecting piece wiring harnessadapter flap, rear	1 pin	3							
16	161 971 990 A	terminal pin housing F >> 31-L-400 000	1 pin	1							



Model	Year	MG	SG	Illustration	VIN No.	Update	17:51	18.02.20100		ETKA	
PA	90	9	71	243-00		336					

Pos	Part Number	Name	Remarks	Qty	Model	Pos	Part Number	Name	Remarks	Qty	Model
(21)	357 906 231	flat contact housing	1.8ltr.	1							
(21)	357 972 752	flat contact housing	2 pin 1.6ltr.	1							
21	357 972 754	flat contact housing	4 pin	1	16V						
22	357 972 754	flat contact housing	4 pin 2.0ltr.	1							

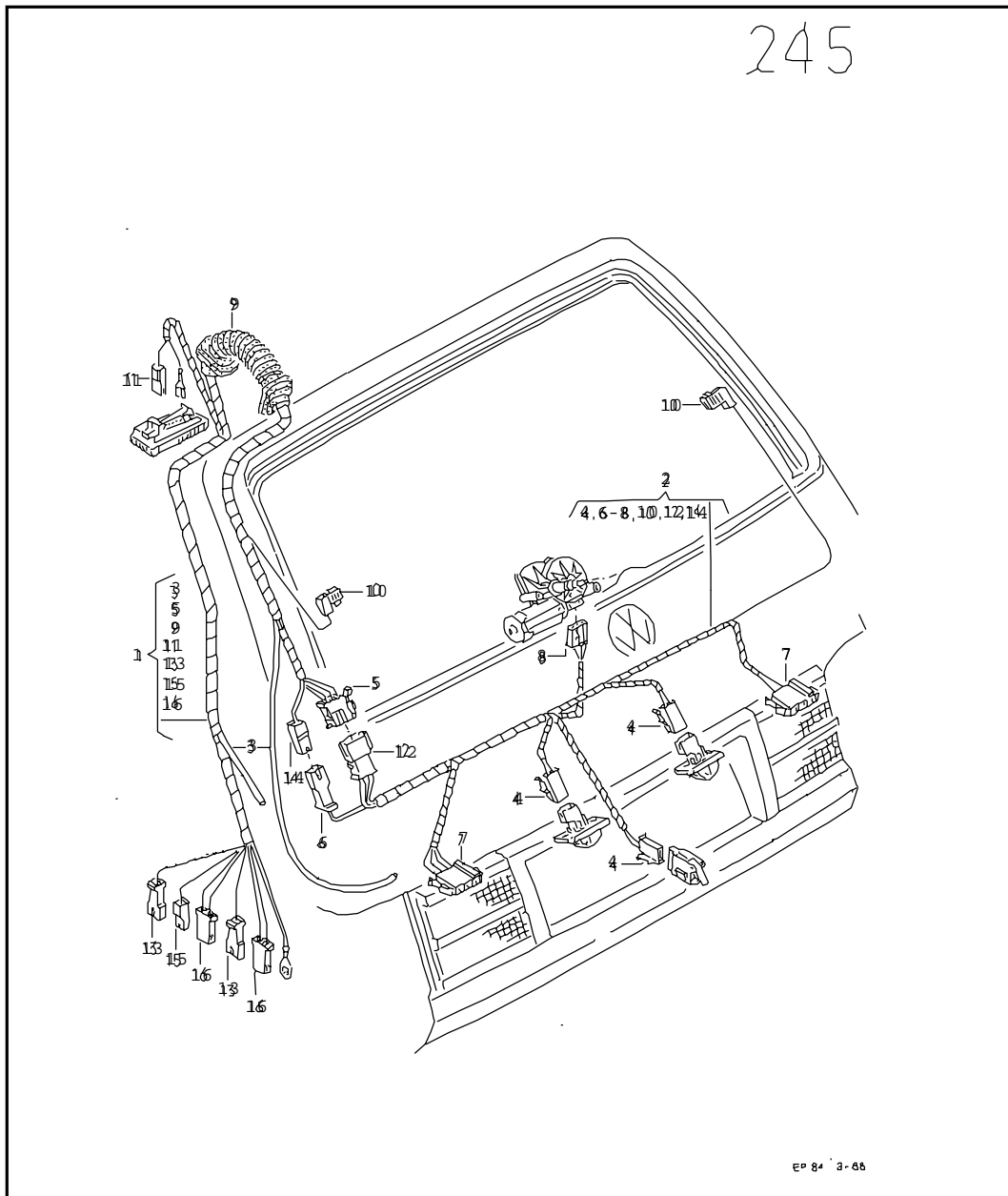

Model	Year	MG	SG	Illustration	VIN No.	Update	17:51	18.02.20100		ETKA	
PA	90	9	71	245-00		336					





Pos	Part Number	Name	Remarks	Qty	Model
		loom for luggage compl. rear			squareback
(1)	333 971 145 B	wiring harnessadapter flap, rear F >> 31-M-240 000*		1	
(1)	333 971 145 N	wiring harnessadapter flap, rear F 31-M-240 001>>*	also use:	1	
			111 971 921 B	1	
(2)	333 971 147 F	loom for luggage compl. rear		1	
3	867 955 961 A	tube	5X1X5600MM	1	
4	191 906 231 A	flat contact housing	2 pin	3	
5	357 907 968 A	flat contact housing	6 pin	1	
6	161 971 976 A	flat connector housing	1 pin	1	
7	321 945 248	flat contact housing	3 pin	2	
8	191 971 835	terminal pin housing	3 pin	1	
9	333 971 840	bellows	39X29/18/38X22	1	
10	211 971 921	angled connector	1 pin	2	
-	333 035 562	adapter		2	VARIANT
-	333 035 566	cap		2	VARIANT
11	111 971 921 B	terminal pin housing	1 pin	1	
12	333 941 973	flat contact housing with helper contact catch	6 pin	1	
13	161 971 976 A	flat connector housing connecting piece loom, rear	1 pin	2	
14	161 971 990 A	terminal pin housing	1 pin	1	
14	161 971 990 A	terminal pin housing	1 pin	1	
15	161 971 990 A	terminal pin housing connecting piece loom, rear	1 pin	1	
16	171 971 999 A	rd. connector sleeve housing connecting piece loom, rear	2 pin	2	

Model	Year	MG	SG	Illustration	VIN No.	Update	17:51	18.02.20100		ETKA	
PA	90	9	71	245-00		336					



Pos	Part Number	Name	Remarks	Qty	Model	Pos	Part Number	Name	Remarks	Qty	Model
-	191 972 701	terminal pin housing F 31-M-240 001>>*	1 pin	3							
	191 972 702	flat contact housing F 31-M-240 001>>*	2 pin	1							
-	191 972 711	flat connector housing F 31-M-240 001>>*	1 pin	3							

Model	Year	MG	SG	Illustration	VIN No.	Update	15:18	18.02.20100		ETKA	
PA	90	9	71	249-00		336					



Pos	Part Number	Name	Remarks	Qty	Model
		list of locally-made loom			
01		electric cable			
02		insulating hose			
1		loom for door			
2		loom for interior light			
3		loom for reading light			
4		loom for tail light			
5		loom for heated jet			
6		loom for rear fog light	relay		
7		wiring harness for fuel pump			16V
8		loom for headlamp washer system and/or intake manifold pre-heater			
9		loom for beam length adjustment			
10		loom for heated seats			
11		loom for backup light	switch		
12		loom horn			

Model	Year	MG	SG	Illustration	VIN No.	Update	15:18	18.02.20100		ETKA	
PA	90	9	71	249-00		336					



Pos	Part Number	Name	Remarks	Qty	Model	Pos	Part Number	Name	Remarks	Qty	Model
13		loom for electric sliding roof				29		loom warning time relay			
14		loom for fan				31		loom for anti-theft alarm system			
15		loom for luggage boot light				32		loom catalyst service kit -lambda controlled--			
16		loom for oil pressure switch oil temperature gauge									
17		wiring harnessadapter catalyst control									
18		loom for heater									
19		loom for carburetor									
20		wiring harness for day driving headlights									
21		loom for diagnosis									
22		loom for cruise control system									
23		wiring looms			TAXI police						
24		loom heater pipe									
25		loom for automatic									
26		loom for cruise control system									
27		loom for belt tensioner									

Model	Year	MG	SG	Illustration	VIN No.	Update	15:19	18.02.20100		ETKA	
PA	90	9	71	250-00		336					



Pos	Part Number	Name	Remarks	Qty	Model
		locally-made loom * corrugated pipe, junction * * pieces, clips, retainers, * * grommets, cable ties, * * insulating hose, electric * * cables, single wires and * * seals see catalogue: * * electrical connecting * * elements-ep198 *			
1		wiring harness for door contact switch =====			
-	357 947 231	flat contact housing	2 pin	2	
-	161 971 990 A	terminal pin housing F >> 31-L-400 000	1 pin	2	
-	191 972 701	terminal pin housing F 31-M-000 001>>	1 pin rhd lhd	1 2	
1		loom for centralized locking =====	door rear		
-	4A0 906 234	flat contact housing	4 pin	1	
-	357 907 968 A	flat contact housing	6 pin	1	
-	893 945 521	protective cap	28X10,7	1	
1		loom for window lifter switches in dashboard F 35-M-000 001>> =====	rear		
-	191 972 724	flat contact housing	8 pin	2	
2		loom for interior light F >> 31-L-400 000 =====			
-	191 906 231 B	flat contact housing	3 pin	1	
-	357 971 739 A	bracket, self-adhesive		X	

Model	Year	MG	SG	Illustration	VIN No.	Update	15:19	18.02.20100		ETKA	
PA	90	9	71	250-00		336					



Pos	Part Number	Name	Remarks	Qty	Model	Pos	Part Number	Name	Remarks	Qty	Model
-	161 971 989 C	terminal pin housing	2 pin	1		6		loom for rear fog light for trailer towing =====	relay		
-	171 971 999 A	rd. connector sleeve housing sun vizor with illuminated mirror	2 pin	1		-	161 937 501 B	relay plate	9 pin	1	
-	171 971 999 B	rd. connector sleeve housing	3 pin	2		-	191 972 701	terminal pin housing	1 pin	1	
-	171 971 999 C	rd. connector sleeve housing	4 pin	1		-	191 972 711	flat connector housing	1 pin	2	
3		loom for reading light =====	rear			7		wiring harness for fuel pump =====			16V
-	161 971 976 A	flat connector housing	1 pin	2	TAXI	-	191 906 232 A	flat contact housing	2 pin	1	
-	191 906 231 B	flat contact housing	3 pin	2		-	443 906 102 B	grommet	18X20,5	1	
-	171 971 998 B	round connector housing	3 pin	1		-	811 972 575	round connector housing	2 pin	1	
-	171 971 998 C	round connector housing	4 pin	1	TAXI	-	811 972 575	round connector housing	2 pin	1	
4		loom for tail light =====	right		notchback	-	N 901 726 02	electric cable in coils of 50m high temperature, fuel and lubricant resistant 'order unit 50'	W1,5	*	
-	191 906 231 C	flat contact housing	4 pin	1		8		loom for headlamp washer system =====			
-	191 906 231 E	flat contact housing	6 pin	1		-	357 907 968	terminal pin housing	1 pin	1	
-	357 971 968	flat contact housing with helper contact catch	8 pin	1	rhd	-	357 941 968	flat contact housing with helper contact catch connector location: B	6 pin	1	
5		loom for heated jet =====				-	161 971 976 A	flat connector housing	1 pin	1	
-	357 957 861	grommet	28/6,4	1		-	431 971 995	terminal pin housing	1 pin	1	
-	161 971 988 C	flat connector housing	2 pin	2		8		loom for headlamp washer system and/or intake manifold pre-heater for vehicles without air conditioner =====	pump		
-	431 971 995	terminal pin housing	1 pin	1							
-	191 972 711	flat connector housing F 31-M-000 001>>	1 pin	1							
-	357 972 761	flat contact housing F >> 31-L-400 000	1 pin	1							

Model	Year	MG	SG	Illustration	VIN No.	Update	15:19	18.02.20100		ETKA	
PA	90	9	71	250-00		336					



Pos	Part Number	Name	Remarks	Qty	Model	Pos	Part Number	Name	Remarks	Qty	Model
-	323 971 919	grommet	28/11	1		-	357 972 741	single wiring seal	5,6X7,8 blue	4	
-	161 971 989 C	terminal pin housing	2 pin	1				for wire cross section:	1,0		
-	161 971 990 A	terminal pin housing	1 pin	1		-	357 972 752	flat contact housing	2 pin	1	
-	443 906 231	terminal pin housing for vehicles with intake manifold pre-heater	2 pin	1		-	357 972 762	flat connector housing	2 pin		
-	447 919 141	protective cap for vehicles with intake manifold pre-heater		1		12		loom horn =====			
-	431 971 995	terminal pin housing for vehicles with intake manifold pre-heater	1 pin	1		-	191 919 083	protective cap horn	32X10		
							F	>> 31-L-400 000		2	
							dual horn			4	
							F	>> 31-L-400 000			
						-	357 951 772	flat contact housing horn	2 pin		
9		loom for beam length adjustment =====					F 31-M-000 001>>			1	
							dual horn			2	
							F 31-M-000 001>>				
-	191 941 336	flat contact housing	7 pin	1		-	357 972 741 A	single wiring seal	5,6X7,8 red	2	
-	161 971 989 C	terminal pin housing F >> 31-L-400 000	2 pin	1				for wire cross section:	1,5		
-	431 971 995	terminal pin housing F >> 31-L-400 000	1 pin	1		-	357 972 762	flat connector housing	2 pin	1	
-	1J0 972 722	terminal pin housing F 31-M-000 001>>	4 pin	1		-	357 972 743	single wiring seal	9,0X23,5 blue		
								for wire cross section:	1,5		
							horn			2	
							F 31-M-000 001>>			4	
							dual horn				
							F 31-M-000 001>>				
10		loom for heated seats =====	switch			13		loom for electric sliding roof			
-	321 971 946	flat contact housing	7 pin	1			F >> 31-L-400 000				
-	431 971 995	terminal pin housing	1 pin	1			=====				
-	171 971 999 C	rd. connector sleeve housing	4 pin	1		-	357 959 869	terminal pin housing	5 pin	1	
						-	357 971 968 B	flat contact housing with helper contact catch	12 pin	1	
								connector location:	D		
11		loom for backup light =====	switch			-	431 971 995	terminal pin housing	1 pin	1	
						-	811 972 575	round connector housing	2 pin	1	

Model	Year	MG	SG	Illustration	VIN No.	Update	15:19	18.02.20100		ETKA	
PA	90	9	71	250-00		336					

Pos	Part Number	Name	Remarks	Qty	Model	Pos	Part Number	Name	Remarks	Qty	Model
14		loom for fan =====				-	803 971 892	grommet	3X25	1	
-	357 959 545	terminal pin housing	6 pin	1		-	357 972 741 A	single wiring seal for wire cross section:	5,6X7,8 red 1,5	2	
-	161 971 976 A	flat connector housing F >> 31-L-400 000	1 pin	1		-	357 972 763	flat connector housing	3 pin	1	
-	533 972 524	round connector housing	5 pin	1		17		loom catalyst control =====			
-	191 972 761	flat contact housing F 31-M-000 001>>	1 pin	1		-	533 867 910 A	felt strip (adhesive) 'order unit 25'	20X1X880MM	X	
14		wiring harnessadapter fuse electric fan motor =====				-	161 937 501 B	relay plate	9 pin	1	
-	161 937 501	fuse box for flat fuses	2 pin	1		-	431 971 995	terminal pin housing	1 pin	1	
-	357 959 968 B	flat contact housing with helper contact catch connector location: N	6 pin	1		-	171 971 998 A	round connector housing	2 pin	1	
-	191 972 751	flat contact housing	1 pin	1		-	357 972 761	flat contact housing	1 pin	1	
-	191 972 751	flat contact housing	1 pin	1		17		wiring harnessadapter catalyst control F 31-L-000 001>> =====			"J.."
-	191 972 761	flat contact housing	1 pin	1		-	161 937 501 B	relay plate	9 pin	1	
15		loom for luggage boot light =====			notchback	-	431 971 995	terminal pin housing	1 pin	1	
-	111 971 921 B	terminal pin housing	1 pin	1		-	171 971 998 A	round connector housing	2 pin	1	
-	161 971 976 A	flat connector housing	1 pin	1		-	357 972 761	flat contact housing	1 pin	1	
-	161 971 990 A	terminal pin housing	1 pin	1		18		loom temperature sensor =====	inner		
16		loom for oil pressure switch oil temperature gauge =====				-	191 906 231 A	flat contact housing	2 pin	1	
-	191 919 083	protective cap	32X10	2		-	171 971 934	terminal pin housing	2 pin	1	
						19		loom for carburetor =====			



Model	Year	MG	SG	Illustration	VIN No.	Update	15:19	18.02.20100		ETKA	
PA	90	9	71	250-00		336					

Pos	Part Number	Name	Remarks	Qty	Model	Pos	Part Number	Name	Remarks	Qty	Model
-	161 971 970	terminal pin housing	3 pin	1							
-	357 972 741 A	single wiring seal for wire cross section:	5,6X7,8 red 1,5	3		22		wiring harnessadapter cruise control system F >> 31-L-400 000 =====			
-	357 972 763	flat connector housing	3 pin	1		-	357 907 968 A	flat contact housing connector location:	6 pin W	1	
20		wiring harness for day driving headlights =====				-	161 971 976 A	flat connector housing	1 pin	1	
-	161 971 990 A	terminal pin housing F >> 31-L-400 000	1 pin	2		-	161 971 990 A	terminal pin housing	1 pin	1	
-	191 972 711	flat connector housing F 31-M-000 001>>	1 pin	2		23		loom for two-way radio =====			TAXI
-		* corrugated pipe, junction * * pieces, clips, retainers, * * grommets, cable ties, * * insulating hose, electric * * cables, single wires and * * seals see catalogue: * * electrical connecting * * elements-ep198 *				-	N 017 131 11	flat fuse 19/2x5	10-red	1	
21		loom for diagnosis connecting piece loom, rear =====			1F,PB,PF,RP	-	161 937 501	fuse box for flat fuses	2 pin	1	
-	161 971 976 A	flat connector housing	1 pin	1		-	111 971 921 B	terminal pin housing	1 pin	2	
-	161 971 990 A	terminal pin housing	1 pin	1		-	431 971 995	terminal pin housing	1 pin	1	
-	431 971 995	terminal pin housing	1 pin	1		23		loom alarm switch =====			TAXI
-	443 972 580	flat contact housing	2 pin	1		-	113 941 189	grommet	24/6	1	
21		loom for diagnosis connecting piece fuse box/relay plate =====			1F,RP,PF,PB, 2E,AAM,9A, AAA	-	171 971 934	terminal pin housing	2 pin	1	
-	443 972 577 E	flat contact housing	2 pin	1		23		loom ashtray light =====			TAXI
-	191 972 712	flat connector housing	2 pin	3		-	191 906 231 A	flat contact housing F 31-M-000 001>>	2 pin	3	
						-	431 971 995	terminal pin housing	1 pin	1	
						-	191 972 701	terminal pin housing	1 pin	1	



Model	Year	MG	SG	Illustration	VIN No.	Update	15:19	18.02.20100		ETKA	
PA	90	9	71	250-00		336					

Pos	Part Number	Name	Remarks	Qty	Model	Pos	Part Number	Name	Remarks	Qty	Model
-	191 972 702	flat contact housing F >> 31-L-400 000	2 pin	3		-	431 971 995	terminal pin housing	1 pin	1	
-	191 972 711	flat connector housing	1 pin	1		25		loom for automatic selector lever =====			
23		loom =====			police	-	191 906 231 A	flat contact housing	2 pin	1	lhd
-	323 971 919	grommet	28/11	1		-	191 972 702	flat contact housing	2 pin	1	
-	161 971 988 C	flat connector housing	2 pin	3		-	191 972 704	terminal pin housing	4 pin	1	
-	161 971 989 C	terminal pin housing	2 pin	2		-	191 972 732	terminal pin housing	4 pin	1	lhd
23		loom switch bracket rotating warning light high volume horn =====			police	-	191 972 733	terminal pin housing	6 pin	1	rhd
-	191 919 083	protective cap	32X10	2		25		wiring harnessadapter multi-function switch for automatic transmission =====			
-	113 941 189	grommet	24/6	1				high temperature resistant materials must be used =====			
-	803 971 831	terminal pin housing	6 pin	1		-	191 906 357	flat contact housing	7 pin	1	
-	111 971 921 B	terminal pin housing	1 pin	9		-	357 906 736 B	angled protective cap		1	
-	161 971 988 C	flat connector housing	2 pin	1		-	191 927 907	protective cap	16X25	1	
-	443 971 969	flat connector housing	4 pin	1		-	357 972 741 A	single wiring seal	5,6X7,8 red for wire cross section: 1,5	6	
24		loom heater pipe =====			RA,SB	-	357 972 766	flat connector housing	6 pin	1	
-	443 906 231	terminal pin housing	2 pin	1		26		loom for cruise control system =====	pump		
-	447 919 141	protective cap terminal pin housing	2 pin	1		-	113 941 189	grommet	24/6	1	
-	323 971 919	grommet	28/11	1		-	113 945 525	terminal pin housing	3 pin	1	
-	161 971 989 C	terminal pin housing for vehicles with headlight washer system	2 pin	1							
-	161 971 990 A	terminal pin housing for vehicles with headlight washer system	1 pin	1							



Pos	Part Number	Name	Remarks	Qty	Model	Pos	Part Number	Name	Remarks	Qty	Model
-	171 957 911	boot terminal pin housing	5 pin	1				loom for anti-theft alarm system door lock			
-	171 971 999 B	rd. connector sleeve housing	3 pin	1				=====			
27		loom for belt tensioner									
-	113 941 189	grommet	24/6	1			191 972 702	flat contact housing	2 pin	1	
-	113 945 525	terminal pin housing	3 pin	1			191 972 702	flat contact housing	2 pin	1	
-	113 945 525	terminal pin housing	3 pin	1			191 972 712	flat connector housing	2 pin	1	
-	171 957 911	boot terminal pin housing	5 pin	1			357 972 741 A	single wiring seal	5,6X7,8 red	6	
-	431 971 995	terminal pin housing	1 pin	1				for wire cross section:	1,5		
-	171 971 999 B	rd. connector sleeve housing	3 pin	1				flat contact housing	3 pin	2	
-	191 972 702	flat contact housing	2 pin	2		32		loom catalyst service kit -lambda controlled--			
-	357 972 741 A	single wiring seal	5,6X7,8 red	4				=====			
-		for wire cross section:	1,5				161 971 970	terminal pin housing	3 pin	1	
-	357 972 752	flat contact housing	2 pin	2			161 971 990 A	terminal pin housing	1 pin	1	
-	191 972 711	flat connector housing	1 pin	1			161 937 501 B	relay plate	9 pin	1	
29		loom warning time relay					161 937 501	fuse box for flat fuses	2 pin	1	
-	431 971 995	terminal pin housing	1 pin	1			N 017 131 11	flat fuse	19/2x5 10-red	1	
-	171 971 998 A	round connector housing	2 pin	1			111 937 078	cable connector	4 pin	X	
-	191 972 714	flat connector housing	4 pin	1							
-	357 972 741 A	single wiring seal	5,6X7,8 red	2							
-		for wire cross section:	1,5								
-	357 972 752	flat contact housing	2 pin	1							

Model	Year	MG	SG	Illustration	VIN No.	Update	16:14	09.02.20100		ETKA	
PA	90	9	98	REP		336					

Pos	Part Number	Name	Remarks	Qty	Model
>	357 998 001 B	1 set of wiper blades F >> 31-L-400 000 comprising:		1	
	357 955 425	wiper blade		1	
	357 955 425 A	wiper blade with air vanes		1	
>	357 998 001 D	1 set of wiper blades F 31-M-000 001>> comprising:		1	
	357 955 425 C	wiper blade	530MM	1	
	357 955 425 D	wiper blade with air vanes	530MM	1	
>	191 998 015	repair kit battery comprising:		1	
	191 915 505	adapter - breather		1	
	251 915 505	plug		1	
		o-ring		6	
>	028 998 019	retrofit set for glow plugs and relay comprising:		1	diesel eng.
N	102 130 02	glow plug		4	
	191 911 261 C	control unit for glow plug		1	
>	357 998 101	installat. set for turn signal comprising:	side	1	
		turn signal	side	2	
	357 971 337	wiring loom for side turn signal		1	
N	906 333 01	cable binder with bracket for welded pin:	10X100	5	
N	906 661 01	cable binder	4,5X200	2	



Model	Year	MG	SG	Illustration	VIN No.	Update	16:14	09.02.20100		ETKA	
PA	90	9	98	REP		336					

Pos	Part Number	Name	Remarks	Qty	Model	Pos	Part Number	Name	Remarks	Qty	Model
>	357 998 131	1 set of flat fuses comprising:		X		>	1H0 998 301 A	retrofit kit for immobilizer comprising:	lhd	1	PASSAT
N	017 131 5	flat fuse 19/2x5	10-red	2			141 951 253 B	relay		2	
N	017 131 6	flat fuse 19/2x5	15-light blue	2			3A1 953 221	bracket		1	
N	017 131 7	flat fuse 19/2x5	20-yellow	1			1H0 953 253	coded lock with loom		1	
N	017 131 8	flat fuse 19/2x5	25-natural.col	1			1H0 953 257	control unit for anti-theft device		1	
N	017 131 9	flat fuse 19/2x5	30-light green	1				with:			
>	357 998 139	halogen fog lamp for service installation comprising:		1				key		2	
	357 941 699	halogen fog lamp	left	1			867 955 499	packing	100X15X100MM	1	
	357 941 700	halogen fog lamp	right	1			535 953 259	adapter sleeve		1	
	357 941 625 D	trim	left	1			1H1 971 809	loom for anti-theft device		1	
	357 941 626 D	trim	right	1				wiring harnessadapter		1	
	141 951 253 B	relay		1			N 015 439 1	speed nut	B4,8X16,5X13	2	
		loom for fog lamps		1			N 013 969 4	tapping screw, fill. hd.	B4,8X16	2	
N	013 969 4	tapping screw, fill. hd.	B4,8X16	6			N 902 412 03	fillister hd. screw	M4X20	1	
N	013 969 4	tapping screw, fill. hd.	B4,8X16	6				instruction manual		1	
N	015 448 1	speed nut	ST4,2X16X11	6				stickers		2	
N	012 005 3	lock ring	B5	6			D 173 KD2 A1	as required use:	D 173 KD2 A1		
N	017 131 12	flat fuse 19/2x5	15-light blue	1							
N	020 902 2	cable binder	6X246	3							
N	903 591 01	rivet	6,5X15	4							
		fitting instructions									
		template	left	1							
		template	right	1							

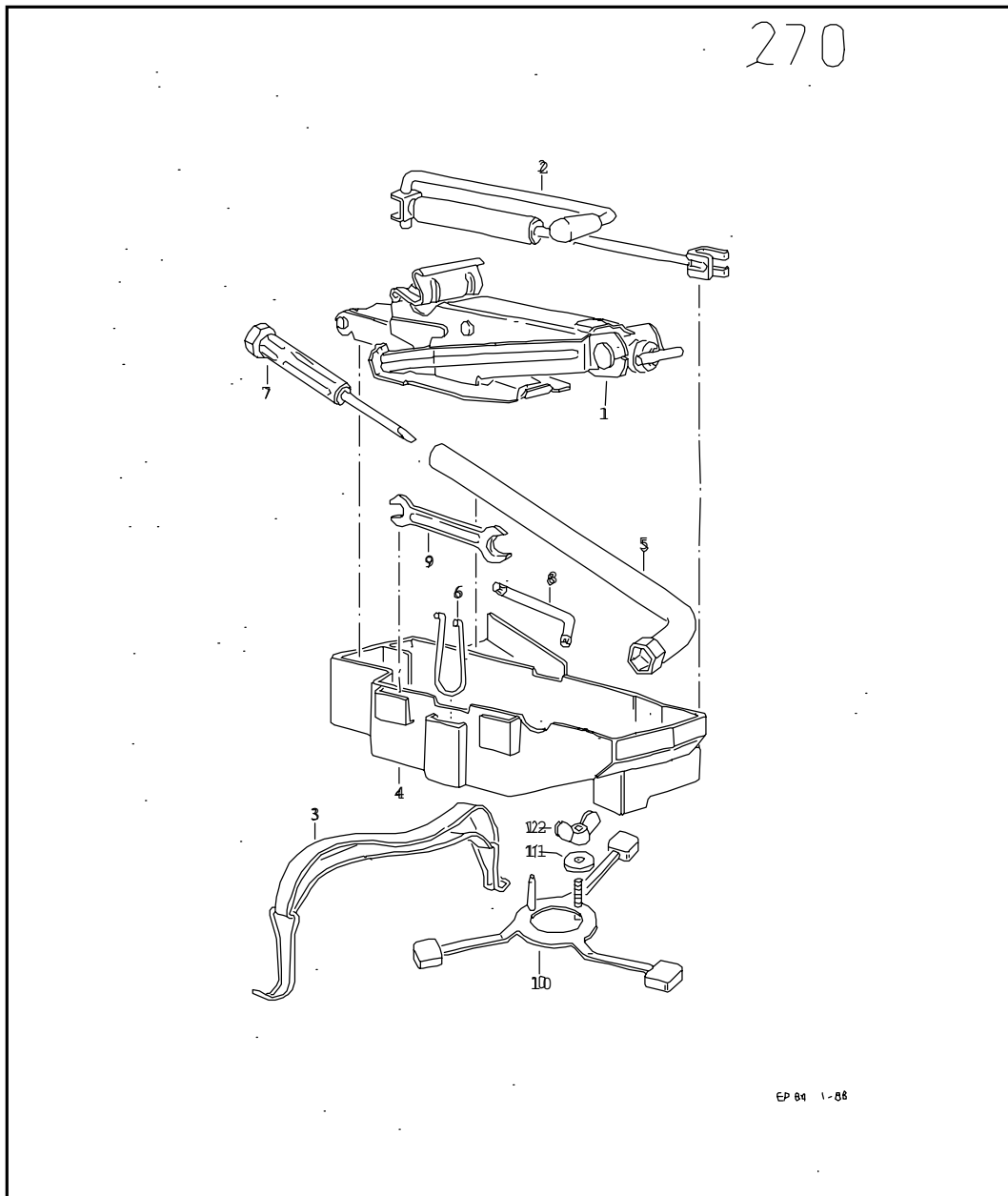

Model	Year	MG	SG	Illustration	VIN No.	Update	18:14	09.02.20100		ETKA	
PA	90	0	11	270-00		336					





Pos	Part Number	Name	Remarks	Qty	Model
		jack tools			
1	3A0 011 031 B	jack			
-	191 011 116	plate		1	"AUS"
2	357 011 221 A	folding crank for jack		1	
3	191 011 247 A	retaining strap		1	
4	191 012 115 C	tool box	for wheel disc: 14"	1	
	7/91 7/91 2BC	graphite			
(4)	535 012 115 B	tool box		1	
5	431 012 235 A	socket wrench for wheel bolt and spark plug	17MM/21MM	1	
-	021 012 213	tool for spark plug connector		1	AAA
6	867 012 243	removal tool		1	
7	535 012 255 A	screwdriver for slotted and phillips head screws		1	
8	321 012 256	angled screwdriver		1	
9	N 030 057 4	wrench	10X13	1	
10	333 601 125 A	packing		1	
	6/88 7/91 01C	satin black			
11	823 199 347	washer	40X2,5	1	
12	N 011 175 2	wing nut	M8	1	
		stickers			
-	323 000 333	sticker for headlight beam length adjustment	1,2%	1	
-	191 000 395	sticker for spare wheel		1	
-	191 010 052 A	sticker for spare wheel	MAX.80KM/H/ MAX.50MPH	1	
-	4A0 010 114 S	sticker	'achtung '	1	

Model	Year	MG	SG	Illustration	VIN No.	Update	18:14	09.02.20100		ETKA	
PA	90	0	11	270-00		336					



Pos	Part Number	Name	Remarks	Qty	Model	Pos	Part Number	Name	Remarks	Qty	Model
		'hochspannung vor dem berueh-' 'ren der zuendanlage motor ' 'abstellen / kuehlerventila-' 'tor kann jederzeit anlaufen ' 'danger high voltage - switch' 'off engine before touching ' 'ignition system / radiator ' 'fan may start at any time ' 'attention ! haute tension ' 'arreter le moteur avant de ' 'toucher a l'allumage / ' 'le vetilateur peut se' 'declencher a tout moment '				-	037 010 057 R	sticker 'bleifrei unleaded sans plomb' ' oder or ou ' 'verbleit leaded avec plomb' 'oktan min. 98 roz/ron'		1	
						-	037 010 057 Q	sticker 'bleifrei unleaded sans plomb' ' oder or ou ' 'verbleit leaded avec plomb' 'oktan min. 91 roz/ron'		1	
						-	034 010 017 B	sticker 'unleaded fuel with inscription in language:	MIN.91 ROZ/RON CLC 87 "D..","GB." "F.."	1	
						-	030 010 057 S	sticker 'bleifrei unleaded sans plomb' ' oder or ou ' 'verbleit leaded avec plomb' 'oktan min. 95 roz/ron'		1	
						-	034 010 006 C	sticker 'bleifrei super' 'premium unleaded fuel only ' 'supercarburant sans plomb '	MIN.95 ROZ/RON	1	
-	191 010 039	sticker 'when the "gb." 'vehicle is stationary,always' 'apply the foot brake when ' 'engaging a driving range '		1	"J.."	-	034 010 105 K	sticker min. roz. 91 'bleifrei super - bleifrei ' 'normal zul.' / unleaded fuel ' 'only - premium recomm. ' 'carburant sans plomb - ' 'super rec. '		1	
-	7M0 010 088	sticker with pictogram for shift gate		1		-	030 010 046 F	sticker 'bleifrei super plus 98roz/ron 'oktan min. 95 roz/ron' 'premium unleaded fuel only' 'super carburant sans plomb'		1	
-	357 010 049 E	sticker 'radiocodierung'		2		-	000 010 007 F	sticker 'achtung - fahrzeug ist auf den betrieb mit bleifreiem superkraftstoff 95roz umgestell. abweichenden zueneinstellwert beachten !		1	"D.."
-	000 010 018 C	sticker 'unleaded' 'fuel only / uniquement ' 'carburant sans plomb'		1		-	051 000 363	sticker for vacuum hose routing diagram F 31-M-000 001>>		1	RP
-	068 010 014 S	sticker 'achtung turbo' 'diesel' ' nur oele nach ' ' vw-norm 50 500 verwenden'		1		-	021 010 058 G	sticker for vacuum hose routing diagram		1	AAA
-	037 010 049 R	sticker 'achtung ! bei ' 'oelstand ueber max. gefahr ' 'von katalysatorschaeden ' 'attention ! to avoid damage ' 'on catalyst oil should ' 'not exceed maximum level '		1							
-	068 010 020	sticker 'diesel-gazole'		1							

Model	Year	MG	SG	Illustration	VIN No.	Update	18:14	09.02.20100		ETKA	
PA	90	0	11	270-00		336					



Pos	Part Number	Name	Remarks	Qty	Model	Pos	Part Number	Name	Remarks	Qty	Model
-	357 010 050 D	sticker for tire pressure F 31-M-000 001>>		1	sedan: 1Y,EZ,AAM	-	333 010 043 R	sticker for tire pressure for vehicles with self-levelling system		1	squareback: PB,PF
-	357 010 050 E	sticker for tire pressure F 31-M-000 001>>		1	sedan: RP,SB,AAZ	-	333 010 042 N	sticker for tire pressure		1	squareback: KR,9A
-	357 010 050 G	sticker for tire pressure		1	sedan: 2E	-	333 010 032 N	sticker for tire pressure		1	squareback: RF,1F
-	357 010 050 H	sticker for tire pressure F 31-M-000 001>>		1	sedan: 9A,KR,AAA	-	333 010 044 D	sticker for tire pressure		1	squareback: "AUS":9A
-	357 010 042 F	sticker for tire pressure F 31-M-000 001>>		1	sedan: "AUS":9A	-	8A0 010 122 E	sticker, engine data "s.."		1	RP
-	357 010 042 D	sticker for tire pressure		1	sedan: PB,PF	-	8A0 010 122 E	sticker, engine data "s.."		1	RP
-	333 010 042 J	sticker for tire pressure		1	squareback: AAM						
-	333 010 042 R	sticker for tire pressure for vehicles with self-levelling system		1	squareback: AAM						
-	333 010 050 M	sticker for tire pressure		1	squareback: AAA						
-	333 010 050 R	sticker for tire pressure		1	squareback: 2E						
-	333 010 050 S	sticker for tire pressure for vehicles with self-levelling system		1	squareback: 2E						
-	333 010 042 K	sticker for tire pressure		1	squareback: RP,SB,AAZ						
-	333 010 043 P	sticker for tire pressure for vehicles with self-levelling system		1	squareback: SB,RP,AAZ						
-	333 010 042 M	sticker for tire pressure		1	squareback: PB,PF						

Model	Year	MG	SG	Illustration	VIN No.	Update	15:06	18.02.20100		ETKA	
ZPA	90	0	01	1-01		336					



Pos	Part Number	Name	Remarks	Qty	Model
	3B0 035 152	radio install time: stereo radio with cassette	genuine vw 15MIN 'VW BETA' genuine vw radio part: UKW, MW, LW rds seek pll-tuning cassette part: autoreverse amplifier: 2X20W telephone mute	1	PASSAT 97 97>KW 32/97
	3B0 035 152 A	anti-theft lock stereo radio with cassette	code card 'VW BETA' genuine vw radio part: UKW, MW, LW rds cassette part: autoreverse amplifier: 2X20W telephone mute	1	PASSAT KW33/97>98
	1J0 035 152 B	stereo radio with cassette	'VW BETA' red/blue radio part: UKW, MW, LW rds cassette part: autoreverse amplifier: 2X20W telephone mute	1	PASSAT 99>12/98
	1J0 035 152 C	stereo radio with cassette with removabl operating device	'VW BETA' 1J0 035 630 red/blue radio part: UKW, MW, LW rds cassette part: autoreverse amplifier: 2X20W telephone mute	1	PASSAT 99>12/98
	1J0 035 152 E	stereo radio with cassette	'VW BETA' 'DOT DISPLAY' radio part: UKW, MW, LW rds cassette part: autoreverse amplifier: 2X20W	1	PASSAT 01/99>

Model	Year	MG	SG	Illustration	VIN No.	Update	15:06	18.02.20100		ETKA	
ZPA	90	0	01	1-01		336					



Pos	Part Number	Name	Remarks	Qty	Model	Pos	Part Number	Name	Remarks	Qty	Model
	1J0 035 152 E	stereo radio with cassette	'VW BETA' 'DOT DISPLAY' radio part: UKW, MW, LW rds cassette part: autoreverse amplifier: 2X20W	1	PASSAT 01/99>		1J0 035 186 B	stereo radio with cassette with cd changer control radio part: UKW, MW, LW cassette part: autoreverse MSS amplifier: 4X20W anti-theft lock code card	VW GAMMA red/blue	1	PASSAT 99>
	1J0 035 152 F	stereo radio with cassette with removabl operating device	'VW BETA' 1J0 035 630 'DOT DISPLAY' radio part: UKW, MW, LW rds cassette part: autoreverse amplifier: 2X20W telephone mute	1	PASSAT 01/99>		1J0 035 186 C	stereo radio with cassette with cd changer control with removabl operating device radio part: UKW, MW, LW cassette part: autoreverse MSS amplifier: 4X20W	VW GAMMA red/blue	1	PASSAT 99>
	3B0 035 186	stereo radio with cassette with cd changer control	VW GAMMA green radio part: UKW, MW, LW ta/tp seek cassette part: autoreverse MSS amplifier: 4X20W gala telephone mute anti-theft lock code card	1	PASSAT 97>KW 32/97		1J0 035 186 D	stereo radio with cassette with cd changer control for models with dsp package radio part: UKW, MW, LW cassette part: autoreverse MSS amplifier: 4X20W	VW GAMMA red/blue	1	PASSAT 99>
	3B0 035 186 A	stereo radio with cassette with cd changer control radio part: UKW, MW, LW cassette part: autoreverse MSS amplifier: 4X20W anti-theft lock but not: for models with dsp package	VW GAMMA red/blue radio part: UKW, MW, LW cassette part: autoreverse MSS amplifier: 4X20W code card	1	PASSAT KW33/97>98		1J0 035 186 E	stereo radio with cassette with cd changer control with removabl operating device for models with dsp package radio part: UKW, MW, LW cassette part: autoreverse amplifier: 4X20W	VW GAMMA red/blue 1J0 035 630 radio part: UKW, MW, LW cassette part: autoreverse amplifier: 4X20W	1	PASSAT 99>
	3B0 035 186 B	stereo radio with cassette with cd changer control part corresponds to: for models with dsp package	VW GAMMA red/blue 3B0 035 186 A	1	PASSAT KW33/97>98		3B0 035 191 A	radio/navigation unit radio component corresponding to: screen illumination,buttons/display: mounting instructions instruction manual buffer release tool	genuine vw VW GAMMA 3B0 035 186 A double din red/blue	1	PASSAT 99>
							3B0 051 530	release tool to be used for:	genuine vw 3B0 035 191 3B0 035 191 A	1	
							3B0 051 530	release tool to be used for:	genuine vw 3B0 035 191 3B0 035 191 A	1	
							1H0 051 530	release tool use for: 1H../3B.. 1H../3B.. 1H../3B..	1 set = 2 parts VW ALPHA VW BETA VW GAMMA	1	

Model	Year	MG	SG	Illustration	VIN No.	Update	15:06	18.02.20100		ETKA	
ZPA	90	0	01	1-01		336					



Pos	Part Number	Name	Remarks	Qty	Model	Pos	Part Number	Name	Remarks	Qty	Model
	000 051 530	release tool	1 set = 2 parts	1		-	Z 051 770	stereo radio with cassette	'DCC 821' PHILIPS	1	
		use for: radio	genuine vw	>7/93		-	Z 051 793	stereo radio with cassette with removabl operating device	'RC 388' PHILIPS	1	
		trim	narrow					radio part:	UKW, MW, LW 36 SPEICHER rds (with eon)		
		radio	TECHNO					cassette part:	autoreverse		
								amplifier part:	4X35W		
-	Z 051 753	stereo radio with cassette	'SANSOUND'	1		-	Z 051 787	stereo radio with cassette with removabl operating device	'RC 448' PHILIPS	1	
		RADIOTEIL:	UKW, MW					radio part:	UKW, MW, LW 36 SPEICHER rds (with eon)		
		CASSETTENTEIL:	AUTOSTOP-LAUF- WERK					cassette part:	autoreverse		
		VERSTAERKERTEIL:	2X12W					amplifier part:	4X35W		
-	Z 051 750 A	stereo radio with cassette	'EMS II'	1		-	Z 051 795	stereo radio with cassette with removabl operating device	'RC 548 RDS' PHILLIPS	1	
-	Z 051 784	stereo radio with cassette MIT ABNEHMBAREN BEDIEN- TEIL	'EMS III'	1				radio part:	UKW, MW, LW, KW 42 SPEICHER rds (with eon)		
		RADIOTEIL:	UKW					cassette part:	autoreverse		
		CASSETTENTEIL:	18 SPEICHER PERMALLOY					amplifier part:	4X35W		
		VERSTAERKERTEIL:	TONKOPF 2X12W								
-	Z 051 749	stereo radio with cassette	'ISAR'	1		-	Z 051 798	stereo radio with cassette with removabl operating device	'RC 578 RDS' PHILLIPS	1	
-	Z 051 783	stereo radio with cassette MIT ABNEHMBAREN BEDIEN- TEIL	'ISAR II'	1				radio part:	UKW, MW, LW, KW 42 SPEICHER autoreverse		
		RADIOTEIL:	UKW, MW, LW					CD-WECHSLERSTEUERUNG:	TITELSUCHLAUF		
		CASSETTENTEIL:	rds (with eon) autoreverse					amplifier part:	4X35W		
		VERSTAERKERTEIL:	4X20W CD-EINGANG								
-	Z 051 772	stereo radio with 'cd'	'ALSTER'	1		-	Z 051 767	stereo radio with 'cd'	'DC 942 RDS' PHILIPS	1	
			TECHNO					radio	blaupunkt		
-	Z 051 773	cd changer magazine		1			000 051 161 B	stereo radio with cassette	LUEBECK RCC 45 BLAUPUNKT	1	
		only for:	Z 051 772					radio part:	UKW		
		radio	PHILIPS						rds (with eon)		
-	Z 051 774	stereo radio with cassette MIT WARNBLINK-LED	'DC 206'	1					codem iii		
		radio part:	UKW						travelstore		
		amplifier:	autostore a-st traffic progr. AIS						seek		
			4X10W								

Model	Year	MG	SG	Illustration	VIN No.	Update	15:06	18.02.20100		ETKA	
ZPA	90	0	01	1-01		336					



Pos	Part Number	Name	Remarks	Qty	Model	Pos	Part Number	Name	Remarks	Qty	Model
			seek scan				0B0 051 164	stereo radio with cassette	DRESDEN	1	
		amplifier part:	4X8W					with removabl operating device	RCR 128		
			aud electronic						BLAUPUNKT		
		anti-theft lock	code + led					radio part:	UKW		
	000 051 215 C	stereo radio with cassette	'SAO PAULO'	1					rds (with eon)		
			BLAUPUNKT						codem iii		
		radio part:	UKW						TA/TP		
			rds (with eon)					cassette part:	autoreverse		
			ta/tp					amplifier part:	4X40W		
			codem iii						dsc software		
			travelstore						telephone mute		
		cassette part:	autoreverse				0B0 051 165	stereo radio with cassette	COBURG RCR 168	1	
		amplifier part:	4X10W					with removabl operating device	BLAUPUNKT		
			telephone mute					radio part:	UKW		
		anti-theft lock	serial number						rds (with eon)		
		with removabl operating device							cassette part:	autoreverse	
	000 051 215 D	stereo radio with cassette	'MONTEVIDEO'	1					s-cps		
			BLAUPUNKT						amplifier part:	4X40W	
		radio part:	UKW						4 x preamp out		
			rds (with eon)						aux in		
			codem iii					as required use:	0B0 051 201		
			ta/tp				0B0 051 166	stereo radio with cassette	FREIBURG	1	
		cassette part:	autoreverse					cd changer control:	RCM 148		
		amplifier part:	4X20W					with removabl operating device	BLAUPUNKT		
			4 x preamp out					radio part:	UKW		
			telephone mute						rds (with eon)		
		anti-theft lock	serial number						autoreverse		
		with removabl operating device							4X35W		
									4 x preamp out		
									aux in		
							0B0 051 167	stereo radio with cassette	SAINT TROPEZ	1	
								cd changer control:	RCM168		

Model	Year	MG	SG	Illustration	VIN No.	Update	15:06	18.02.20100		ETKA	
ZPA	90	0	01	1-01		336					



Pos	Part Number	Name	Remarks	Qty	Model	Pos	Part Number	Name	Remarks	Qty	Model
		with removabl operating device	BLAUPUNKT					radio part:	UKW, MW, LW		
		radio part:	UKW, MW, LW						codem iv		
		cassette part:	autoreverse						dsc software		
			s-cps						tim memo		
		amplifier part:	4X40W					cassette part:	dolby b		
			4 x preamp out						2 motors		
			aux in					amplifier:	4X35W		
		as required use:	0B0 051 201						4 x preamp out		
	000 051 204 C	stereo radio with cassette with cd changer control	HAMBURG RCM 148 blaupunkt	1			000 051 172 A	stereo radio with cassette with cd changer control	KOELN RCM 126 blaupunkt	1	
		radio part:	UKW					enlargeable with:	CDC-F05/A05		
		cassette part:	rds (with eon)					radio part:	UKW, MW, LW		
		amplifier:	dolby b						dsc software		
	000 051 205 B	stereo radio with cassette with cd changer control	HEIDELBERG RCM 126 blaupunkt	1					codem iv		
		enlargeable with:	CDC-F05/A05						tim memo		
		radio part:	UKW					cassette part:	DOLBY B+C		
			rds (with eon)						2 motors		
			dsc software					amplifier part:	4X35W		
			codem iv						4 x preamp out		
			tim memo						keycard		
		cassette part:	2 motors								
		amplifier part:	4X35W								
			4 x preamp out								
	000 051 219 B	stereo radio with cassette with cd changer control	STOCKHOLM RCM 126 blaupunkt	1			000 051 170 B	stereo radio with cassette with cd changer control	BREMEN RCM 127 blaupunkt	1	
		enlargeable with:	CDC F05/A05					radio part:	UKW, MW, LW		
									codem v		
									dsc software		
								cassette part:	dolby b + c		
								amplifier part:	4X35W		
									dsa/dnc		

Model	Year	MG	SG	Illustration	VIN No.	Update	15:06	18.02.20100		ETKA	
ZPA	90	0	01	1-01		336					



Pos	Part Number	Name	Remarks	Qty	Model	Pos	Part Number	Name	Remarks	Qty	Model
			opto input				0B0 051 217	stereo radio with 'cd'	ACAPULCO	1	
			4 x preamp out					cd changer control:	RDM 168		
		as required use:	000 051 209 G					with removabl operating device	BLAUPUNKT		
			000 051 201 B						UKW, MW, LW		
	0B0 051 210	stereo radio with 'cd'	SAN REMO RD168	1					CODEM D		
		with removabl operating device	blaupunkt								
		radio part:	UKW, MW, LW					cd-player part:	DISC NAMING		
			CODEM D					amplifier part:	4X40W		
		cd-player part:	CD-MIX						4 x preamp out		
		amplifier part:	4X40W						aux in		
			4 x preamp out								
			aux in								
			dsc software					as required use:	0B0 051 201		
	0B0 051 216	stereo radio with 'cd'	SEVILLA RDM168	1			0B0 051 218	stereo radio with 'cd'	TORONTO RDM128	1	
		cd changer control:	blaupunkt					with cd changer control	blaupunkt		
		with removabl operating device	UKW, MW, LW								
			rds (with eon)					radio part:	UKW, MW, LW		
			CODEM D						codem iv		
		cd-player part:	CD-MIX						suits for dab		
		amplifier part:	4X40W					cd-player part:	DISC NAMING		
			4 x preamp out					amplifier part:	4X35W		
			aux in						4 x preamp out		
		as required use:	0B0 051 201						aux in		
								as required use:	000 051 201 A		
	000 051 227 A	stereo radio with 'cd'	LAUSANNE	1			000 051 216 B	stereo radio with 'cd'	LONDON RDM 126	1	
			RD 128					with cd changer control	blaupunkt		
			blaupunkt								
		radio part:	UKW, MW, LW					enlargeable with:	CDC F05/A05		
			rds (with eon)								
		amplifier part:	4X35W					radio part:	UKW, MW, LW		
		keycard for car radio	blaupunkt						codem iv		
	8/74	01C	black						rds (with eon)		
	8/74	4XS	blue/red						tim memo		
	8/74	01C	black								
	8/74	4XS	blue/red								
	8/74	6VP	aztec yellow								

Model	Year	MG	SG	Illustration	VIN No.	Update	15:06	18.02.20100		ETKA	
ZPA	90	0	01	1-01		336					



Pos	Part Number	Name	Remarks	Qty	Model	Pos	Part Number	Name	Remarks	Qty	Model
			dsc software				0B0 051 222 B	radio/cd changer pack comprising: stereo radio with cassette with cd changer control cd-changer	MEMPHIS DJ BLAUPUNKT 000 051 171 C 000 051 209 J	1	
		cd-player part:	1 bit d/a conv								
		amplifier part:	4X35W								
			4 x preamp out				0B0 051 236	dab receiver	'D-FIRE 01 blaupunkt	1	
			keycard					as required use: RADIO STOCKHOLM RCM 128 RADIO SYDNEY RCM 128 RADIO TORONTO RDM 128			
	000 051 125	stereo radio with 'cd'	VIKING TMC 128 BLAUPUNKT	1			000 051 116	combined phone and radio unit with cd changer control	AMSTERDAM 127 blaupunkt gsm/ d-network	1	
		radio part:	UKW, MW, LW CODEM D dsc software					radio part:	UKW, MW, LW codem iv rds (with eon)		
		cd-player part:	20-20000HZ					cassette part:	autoreverse s-cps dolby b		
		amplifier part:	4X35WATT					amplifier part:	4X35W		
	000 051 173 A	stereo radio with 'cd' with cd changer control	NEW YORK RDM 127 BLAUPUNKT	1				as required use:	000 051 119 000 051 201 E		
		radio part:	UKW, MW, LW codem v dsc software				0B0 051 116 A	combined phone and radio unit with cd changer control	HELSINKI RTM 127 gsm/ d-network	1	
		cd-player part:	TPM					radio part:	UKW, MW, LW CODEM D		
		cd changer control:	opto input					cassette part:	s-cps		
		amplifier part:	4X35W					amplifier part:	4X35WATT		
			dsa/dnc						4 x preamp out aux in keycard		
		as required use:	000 051 209 G 000 051 201 B								
	0B0 051 222	radio/cd changer pack comprising: stereo radio with cassette with cd changer control cd-changer	KINGSTON DJ BLAUPUNKT 0B0 051 166	1							
	0B0 051 222 A	radio/cd changer pack comprising: stereo radio with cassette with cd changer control cd-changer	LAS VEGAS DJ BLAUPUNKT 0B0 051 167	1							
		as required use:	0B0 051 201								

Model	Year	MG	SG	Illustration	VIN No.	Update	15:06	18.02.20100		ETKA	
ZPA	90	0	01	1-01		336					



Pos	Part Number	Name	Remarks	Qty	Model	Pos	Part Number	Name	Remarks	Qty	Model
		as required use:	0B0 051 201				0S0 051 161 B	stereo radio with cassette	'XR-5800R'	1	
			000 051 201 E					radio part:	UKW, MW, LW		
	0B0 051 116 A	combined phone and radio unit	HELSSINKI	1				cassette part:	autoreverse		
		with cd changer control	RTM 127					amplifier:	4X35W		
			gsm/ d-network					anti-theft lock	serial number		
		radio part:	UKW, MW, LW					as required use:	0S0 051 202		
		cassette part:	s-cps				0S0 051 166	stereo radio with cassette with cd/md changer control with removabl operating device	'XR-C5109 R'	1	
		amplifier part:	4X35WATT					radio part:	red/blue		
			4 x preamp out					cassette part:	UKW, MW, LW		
			aux in					amplifier part:	autoreverse		
			keycard					remote control	REAR PREAMPOUT		
		as required use:	0B0 051 201						0S0 051 202		
			000 051 201 E								
	000 051 119	handset use for: combined phone and radio unit	'TH 07'	1			0S0 051 163 B	stereo radio with cassette with cd/md changer control	'XR-C7200R'	1	
			000 051 116					radio part:	UKW, MW, LW		
	000 051 201 E	remote control	'RCT 07'	1				cassette part:	autoreverse		
		to be used for: official approval	000 051 116					amplifier part:	4X40W		
		install time:	40MIN					remote control	4 x preamp out		
	0B0 051 201	remote control for car radio	RC 08	1					0S0 051 202		
		to be used for:	BLAUPUNKT								
	RADIO	SAINT TROPEZ RCM 168	0B0 051 167								
	PAKET	LAS VEGAS DJ	0B0 051 222 A								
	RADIO	SEVILLA RDM 168	0B0 051 216								
	RADIO	ACAPULCO RDM 168	0B0 051 217								
		radio	sony								
							0S0 051 200 D	stereo radio with 'cd' with removabl operating device	'CDX-4180 R'	1	
								radio part:	UKW, MW, LW		
								cd-player part:	1 bit d/a conv		
								cassette part:	4X40W		
								as required use:	0S0 051 202		
							0S0 051 200 E	stereo radio with 'cd' with removabl operating device	'CDX-4180 RV'	1	
								radio part:	UKW, MW, LW		
								cd-player part:	1 bit d/a conv		
								cassette part:	4X40W		
								as required use:	0S0 051 202		

Model	Year	MG	SG	Illustration	VIN No.	Update	15:06	18.02.20100		ETKA	
ZPA	90	0	01	1-01		336					



Pos	Part Number	Name	Remarks	Qty	Model	Pos	Part Number	Name	Remarks	Qty	Model
	OS0 051 200 E	stereo radio with 'cd' with removabl operating device radio part:	'CDX-4180 RV' sony UKW, MW, LW rds (with eon) ta/tp	1				remote control	OS0 051 202		
		cd-player part:	1 bit d/a conv				050 051 223 A	replacement cd magazine	OS0 051 179		
		cassette part:	4X40W					radio/cd changer pack	'KP-MD 7900 R' sony	1	
		as required use:	OS0 051 202					radio part:	UKW, MW, LW		
	OS0 051 201 B	stereo radio with 'cd' with cd/md changer control radio part:	'CDX-C 580 R' sony UKW, MW, LW rds (with eon) ta/tp	1				md player:	MINIDISC		
		cd-player part:	1 bit d/a conv					cassette part:	autoreverse		
		cassette part:	4X40W				050 051 225 B	cd-player part:	10 CD		
		as required use:	OS0 051 202					amplifier part:	4X40W		
	OS0 051 222 D	radio/cd changer pack	'KP-C 5100 R' sony	1				remote control	OS0 051 202		
		radio part:	UKW, MW, LW					cd-magazine	OS0 051 179		
		rds (with eon)						stereo radio with 'md' with cd/md changer control radio part:	'MDX-C 7900 R' UKW, MW, LW	1	
		cassette part:	autoreverse					md player:	MINIDISC		
		cd-player part:	10 CD					amplifier part:	TRACK +/- 4X40W		
		amplifier part:	4X35W					remote control	4 x preamp out OS0 051 202		
		REAR PREAMPOUT						OS0 051 179	cd-magazine	1	
		remote control	OS0 051 202					to be used for:	SONY for 10 cd's OS0 051 209 B OS0 051 209 D OS0 051 222 A OS0 051 222 D OS0 051 223 OS0 051 223 A		
		cd-magazine	OS0 051 179					OS0 051 202	SAFETY COMMANDER RM-X2S sony	1	
	OS0 051 222 B	radio/cd changer pack with removabl operating device	'KP-C 5109 R' sony red/blue	1				remote control for car radio	contained in: OS0 051 166 OS0 051 163 B OS0 051 222 B OS0 051 222 D OS0 051 223 A OS0 051 225 B		
		radio part:	UKW, MW, LW					release tool	replacement pt		
		rds (with eon)						release tool	1 set = 2 parts	1	
		cassette part:	autoreverse								
		cd-changer	10 CD								
		amplifier part:	4X35W								
		REAR PREAMPOUT									

Model	Year	MG	SG	Illustration	VIN No.	Update	15:08	18.02.20100		ETKA	
ZPA	90	0	01	1-02		336					



Pos	Part Number	Name	Remarks	Qty	Model
-	000 051 201 A	accessories for radios remote control	'RC 05' BLAUPUNKT only for: RCM 104,105	1	
	000 051 201 B	remote control steering wheel remote control to be used for: NEW YORK RDM 127 BREMEN RCM 127 install time:	BLAUPUNKT 000 051 173 A 000 051 170 B 40MIN	1	
	000 051 201 C	remote control steering wheel remote control to be used for: COBURG RCM 127 DUESSELDORF RCM 127 WOODSTOCK DJ install time:	RC 06 BLAUPUNKT 000 051 203 C 000 051 165 C 000 051 222 G 40MIN	1	
	000 051 201 D	remote control	RC 06 H	1	
		centre console to be used for:	blaupunkt		
		LONDON RDM 126	000 051 216 B		
		MUENCHEN RDM 126	000 051 171 C		
		KOELN RCM 126	000 051 172 A		
		BARCELONA RCM 104-A	000 051 221 B		
		WASHINGTON RCM 127	000 051 228		
		STOCKHOLM RCM 126	000 051 219 B		
		HEIDELBERG RCM 126	000 051 205 B		
		ORLANDO DJ	000 051 222 F		
		install time:	40MIN		
	0B0 051 201	remote control for car radio to be used for: RADIO SAINT TROPEZ RCM 168 PAKET LAS VEGAS DJ RADIO SEVILLA RDM 168 RADIO ACAPULCO RDM 168	RC 08 BLAUPUNKT 0B0 051 167 0B0 051 222 A 0B0 051 216 0B0 051 217	1	

Model	Year	MG	SG	Illustration	VIN No.	Update	15:08	18.02.20100		ETKA	
ZPA	90	0	01	1-02		336					



Pos	Part Number	Name	Remarks	Qty	Model	Pos	Part Number	Name	Remarks	Qty	Model
-	000 051 459 B	trim	for: ALPHA, BETA, GAMMA, DELTA and 189X58MM	1		-	000 051 443	adapter FUER STROMVERSORGUNG	8 pin for: BLAUPUNKT	1	87>
		front panel				-	Z 051 824	adapter FUER STROMVERSORGUNG	8 pin for: PHILIPS NECKAR, WESER, MOSEL BLAUPUNKT	1	87>
	1J0 051 443	adapter to connect: radio radio	genuine vw genuine vw AELTER blaupunkt sony	1	VOLKSWAGEN 99>	-	165 051 443 E	adapter for speaker connection	DIN-STECKER for: ALPHA, BETA, GAMMA, DELTA PHILIPS RHEIN, DONAU	1	
		for installation in:			VW 99>	-	Z 051 836	adapter FUER LAUTSPRECHER-ANSCHLUSS	DIN-STECKER for: ALPHA, BETA, GAMMA, DELTA PHILIPS RHEIN, DONAU	1	
	1J0 051 443 A	adapter to connect: radio	genuine vw genuine vw 1J0 035 ...	1	VOLKSWAGEN >98	-	191 035 443 A	adapter wiring loom for loudspeaker	8 pin for: PHILIPS NECKAR, WESER, MOSEL	1	
		for installation in:			VW >98	-	Z 051 823	adapter FUER LAUTSPRECHER-ANSCHLUSS	8 pin for: PHILIPS NECKAR, WESER, MOSEL BLAUPUNKT	1	
	1J0 051 443 B	adapter to connect: hands-off loudspeaker for vehicles with autoradio & mobile phone factory-fitted	genuine vw	1	VOLKSWAGEN 99>	-	000 051 443 A	adapter FUER LAUTSPRECHER-ANSCHLUSS	8 pin for: BLAUPUNKT	1	
						-	000 051 537	adapter FUER ANTENNEN-ANSCHLUSS	for: ALPHA, BETA, GAMMA, DELTA	1	
	1J0 051 445	adapter to connect: connection cable for cd changer to connect with: radio/navigation unit radio	genuine vw 10 pin 1J0 035 ... BETA GAMMA	1		-	191 035 551	adapter FUER ANTENNEN-ANSCHLUSS	for: PHILIPS RHEIN, DONAU, NECKAR, WESER, MOSEL BLAUPUNKT	1	
-	165 051 443 F	adapter FUER STROMVERSORGUNG	4 pin for: ALPHA, BETA, GAMMA, DELTA PHILIPS RHEIN, DONAU	1	>87						
-	Z 051 835	adapter FUER STROMVERSORGUNG	4 pin for: ALPHA, BETA, GAMMA, DELTA PHILIPS RHEIN, DONAU	1	>87						
-	191 035 443 B	adapter wiring loom for radio FUER STROMVERSORGUNG	8 pin for: PHILIPS NECKAR, WESER, MOSEL	1	87>						

Model	Year	MG	SG	Illustration	VIN No.	Update	15:08	18.02.20100		ETKA	
ZPA	90	0	01	1-02		336					



Pos	Part Number	Name	Remarks	Qty	Model	Pos	Part Number	Name	Remarks	Qty	Model
-	Z 051 821	adapter for aerial connection connections: rf coaxial cable for car radio cable angled connector	'ANT 46'	1		-	000 051 176	installation set	BLAUPUNKT not for: QUICK-OUT	1	PASSAT 85>87 SANTANA >84
-	357 051 443	adapter FUER FAHRZEUGE OHNE S-KONTAKT	for: 357 035 152 B 357 035 186 D 357 035 192 B	1		-	000 051 175 P	quick out only for:	BLAUPUNKT 'MAINZ CC 21' 'ACR 3220' 'KONSTANZ CR 21' 'ACR 4220'	1	
-	Z 051 538	iso adapter SPEZIFIKATION: TAUSCH DER ANSCHLUSSPINS A7 UND A4 ZUM ANSCHLIESSEN AN ALLE AUTORADIOS	EA 6179	1		-	000 051 175 Q	quick out only for:	BLAUPUNKT 'STOCKHOLM RCM 104' 'PARIS RCM 104' 'LONDON RDM 104' 'KIEL RD 104' 'MÜNCHEN RD 104'	1	
	357 051 444	adapter for connecting radios with line output booster with: loudspeaker connector/coupling	4 channels VW/AUDI > 8 pin DIN 45326	1		-	000 051 175 R	bracket quick out only for:	BLAUPUNKT 'HEILBRONN RCR 24' 'MONTREUX RCR'	1	
	357 051 444 A	adapter for car radio with: clutch	4 channels 150MM 4 x preamp out sound 2 8 pin DIN 45326	1		-	1H0 051 530	release tool for: VW 1H0 035 ...		1	
	357 051 444 B	adapter for car radio with: connector clutch	4 channels preamp out sound 1 8 pin 8 pin DIN 45326	1			000 051 530	release tool use for: radio radio trim with: genuine vw genuine audi	1 set = 2 parts	2	>7/93
	357 051 444 E	adapter wiring loom for loudspeaker for connecting radios without preamp output active speaker inputs: outputs:	VOTEX 4 channels > VW/AUDI ISO ISO	1		-	321 051 344	gala connection set only for:	'GAMMA' 'GAMMA CD' 'DELTA'	1	PASSAT SCHRIGHECK 84>87
-	Z 051 846	flush-mounted frame for car radio FESTER ZIERBLENDE IN FAHRZEUGE MIT NEUEM GERAETESCHACHT	not for:	1	KÍFER	-	321 051 344	gala connection set only for:	'GAMMA' 'GAMMA CD' 'DELTA'	1	PASSAT VARIANT 84>89 PASSAT notchback 85>89 SANTANA 84>

Model	Year	MG	SG	Illustration	VIN No.	Update	15:08	18.02.20100		ETKA	
ZPA	90	0	01	1-02		336					



Pos	Part Number	Name	Remarks	Qty	Model	Pos	Part Number	Name	Remarks	Qty	Model
-	171 035 343 A	buffer FUER RADIO-HALTERUNG	only for: 'ALPHA' 'BETA' 'GAMMA' 'DELTA' 'DELTA BOSE' 'GAMMA CD'	1			000 051 237	display for on-board computer screen to be used for: videointerface 000 051 235	BLAUPUNKT	1	
-	191 035 373	tone lever	NEGRO for: 171 035 156 171 035 152 A 171 035 172 171 035 186 171 035 192 but with: 191 035 459 191 051 459	1			000 051 238	headphones ANSCHLUSS only in combination with: videointerface 000 051 235	BLAUPUNKT	1	
-	357 058 001	gift wrapping	for: VW also use: 000 058 007	1			000 051 239	radio reversing camera to be used for: videointerface 000 051 235	BLAUPUNKT	1	
-	000 058 007 A	eps side elements	only for: 4D0 035 ...	2	94>		000 051 236	bracket swan-neck to be used for: screen mobile audio video system	BLAUPUNKT	1	
-	Z 051 540	cinch extension cable	with: 0,8M CINCH-STECKER both-sides gold plated for installation in: dash panel	1			000 051 235	radio tv/video interface to be used for: mobile audio video system	BLAUPUNKT	1	
-	Z 051 541	cinch extension cable	with: 5M CINCH-STECKER both-sides gold plated for installation in: luggage comp.	1			- Z 051 399	cleaning cassette cleaning solution with: FUER TONKOPF		1	
-	8D0 051 444	adapter	VOTEX 20-POLIG/ 8-POLIG 18CM	1			- Z 051 402	cleaning-cd for cd changer and for radio with cd player		1	
							- Z 051 402	cleaning-cd for cd changer and for radio with cd player		1	
							- Z 051 401	bag FUER 15 CASSETTEN with: 315X75X130 MM NYLON		1	
							- Z 051 403	zipp fastener and handle with: 'DISC-BAG' 230X160X140 MM NYLON for: 13 CD'S + 1 DUO-CD		1	
								zipp fastener and handle and BOOKLET-TASCHE			

Model	Year	MG	SG	Illustration	VIN No.	Update	15:08	18.02.20100		ETKA	
ZPA	90	0	01	1-03		336					



Pos	Part Number	Name	Remarks	Qty	Model
		booster	replacement pt		
	1J0 035 624	dsp operating part use for: digital sound pack	replacement pt	1	PASSAT LIM.97> VAR.99>
	3B9 035 493 C	bracket for models with dsp package	replacement pt	1	PASSAT VAR.99>
-	Z 051 441	booster 2-KANAL sine-wave power: ELEKTR. LOW-PASS-FILTER:	'DAP 4020' PHILIPS 2 X 60 WATT / 1 X 160 WATT (GEBRUECKT) 5 HZ-100 KHZ 80 HZ	1	
-	Z 051 442	booster 4-KANAL sine-wave power: ELEKTR. LOW-PASS-FILTER:	'DAP 4040' PHILIPS 4 X 60 WATT/ 2 X 160 WATT (GEBRUECKT) 5 HZ-100 KHZ 80 HZ	1	
-	Z 051 438	booster 2-KANAL sine-wave power:	'PROTOVISION' HIGH-END 2 X 60 WATT 4 OHM/2 OHM 7 HZ-500 KHZ IN-CINCH gold plated	1	
	000 051 195	stereo amplifier sine-wave power: max. power: inputs: SUBWOOFER-CROSSOVER	'BSX 120' blaupunkt 2X30W 1X60W 2X60W 1X120W cinch / rca (BRUECKBAR) integrated	1	
	000 051 186 C	booster with 4 speaker outputs amplifier part: frequency crossover	BQX 280 BLAUPUNKT 4X30/2X75W 4 channels cinch / rca integrated	1	

Model	Year	MG	SG	Illustration	VIN No.	Update	15:08	18.02.20100		ETKA	
ZPA	90	0	01	1-03		336					



Pos	Part Number	Name	Remarks	Qty	Model	Pos	Part Number	Name	Remarks	Qty	Model
-	1H0 035 111	cd-changer	replacement pt	1			0S0 051 209 C	cd-changer	CDX-727 for 10 cd's sony	1	
-	1H0 051 179	cd-magazine	only for: 3B0 035 186	1				replacement cd magazine	0S0 051 179 install time: 45MIN		
	3B0 035 111	cd-changer	for 6 cd's genuine vw to be used for: for serv. install. use: fitting kit	1	PASSAT 97> PASSAT VARIANT 97> sedan squareback		0S0 051 209 D	md-changer	'MDX-65' 6 MD'S SONY dimensions: install time: 176X84X128MM 45MIN	1	
	1J6 035 111	cd-changer	for 6 cd's horizontal	1	PASSAT LIM.97> VAR.98>						
		cd-magazine	fitting: only in combination with: BETA/GAMMA blaupunkt		99>						
	3B0 051 179	cd-magazine	for 6 cd's replacement pt genuine vw to be used for:	1	PASSAT 97> PASSAT VARIANT 97>						
		cd-changer	for serv. install. use: 3B5 051 324 3B9 051 324 3B0 051 179		sedan squareback						
-	Z 051 782	cd-changer	'DC 022' PHILIPS 2 X 1 BIT DAC D2B-ANSCHLUSS LINE SUPPLY TITEL SCAN RANDOM TRACK	1							
	000 051 209 G	cd-changer	CDC-F07 with: blaupunkt 10 CD 4A0 051 179 A to be used for: BREMEN RCM 127 NEW YORK RDM 127	1							
	0B0 051 209	cd-changer	CDC-A08 for 10 cd's blaupunkt replacement cd magazine install time: 0B0 051 179 45MIN	1							

Model	Year	MG	SG	Illustration	VIN No.	Update	15:19	18.02.20100		ETKA	
ZPA	90	0	01	1-04		336					



Pos	Part Number	Name	Remarks	Qty	Model
		for cd changer	1H0 035 111		PA 94>96
	1H0 051 179	cd-magazine	only for: 1H0 035 111	1	PA 94>96 sedan
	3A5 035 592	loom	only for: 1H0 035 111	1	PA 94>96 sedan
	3A5 035 201	bracket for cd-changer		1	PA 94>96 sedan
	3A5 035 227 G	retaining clamp	left for: 3A5 035 201	1	PA 94>96 sedan
	3A5 035 227 F	retaining clamp	right for: 3A5 035 201	1	PA 94>96 sedan
	1H0 035 205	bracket for cd-changer	side	1	PA 94>96 sedan
	1H0 035 234	bracket for cd-changer	for: 3A5 035 201	1	PA 94>96 sedan
		for cd changer	1H0 035 111		PA VAR.94>97
	1H0 051 179	cd-magazine	only for: 1H0 035 111	1	squareback 94>97
	3A9 035 592	loom	for: 1H0 035 111	1	squareback 94>97
	3A9 035 229	bracket for cd-changer	right	1	squareback 94>97
	3A9 035 229 A	bracket for cd-changer	left	1	squareback 94>97
		for cd changer	1J6 035 111		PASSAT 97>
	3B0 051 179	cd-magazine	replacement pt 1J6 035 111	1	PASSAT 97> sedan
	3B0 035 592	connection cable radio>coupling point for cd changer	replacement pt 1J6 035 111 also use: 1J0 051 445	1	PASSAT 97> sedan KW18/98>

Model	Year	MG	SG	Illustration	VIN No.	Update	15:19	18.02.20100		ETKA	
ZPA	90	0	01	1-04		336					



Pos	Part Number	Name	Remarks	Qty	Model	Pos	Part Number	Name	Remarks	Qty	Model
	3B5 035 592	connection cable coupling point>cd changer for cd changer	replacement pt 1J6 035 111	1	PASSAT 97> sedan		3B5 051 324	installat. kit for cd-player to be used for: 1J6 035 111 for serv. install. use:	genuine vw 1J6 035 111	1	PASSAT 97>98 sedan
	3B5 035 112 B	bracket for cd changer for serv. install. use:	replacement pt 1J6 035 111 1J0 035 234 A 3B5 687 429 D	1	PASSAT LIM. 97>			lining adapter for vehicles with navigations- system ans integratet autoradio	3B5 867 429 D 1J0 051 445		
	1J0 035 234 A	bracket for cd-changer to be used for: as required use:	genuine vw side 1J6 035 111 N 090 178.2	1	PASSAT 97> sedan		3B5 051 324 A	installat. kit for cd-player to be used for: 1J6 035 111 for serv. install. use:	genuine vw 1J6 035 111	1	PASSAT 99> sedan
		for cd changer	1J6 035 111	1	PA VAR 98>			lining adapter	3B5 867 429 D 1J0 051 445 B		>98
	3B0 051 179	cd-magazine to be used for:	replacement pt 1J6 035 111	1	PASSAT 98> squareback		3B9 051 324	installat. kit for cd-player to be used for: 1J6 035 111 also use:	genuine vw 1J6 035 111	1	PASSAT 98>98 squareback
	3B0 035 592	connection cable radio>coupling point for cd changer for serv. install. use:	replacement pt 1J6 035 111 1J0 051 445	1	PASSAT 98> squareback			adapter for vehicles with navigations- system ans integratet autoradio	1J0 051 445		
	3B9 035 592	connection cable coupling point>cd changer for cd changer	replacement pt 1J6 035 111	1	PASSAT 98> squareback		3B9 051 324 A	installat. kit for cd-player to be used for: 1J6 035 111 with:	genuine vw 1J6 035 111	1	PASSAT 99> squareback
	3B0 051 592	cable set radio>cd changer length: use for: cd-changer also use:	genuine vw 7300MM 1J6 035 111 1J0 051 445	1	PASSAT 98> squareback			attachment screws mounting instructions also use:	1J0 051 445 B		>98
	3B9 035 112 B	bracket for cd changer	genuine vw 1J6 035 111	1	PASSAT 98> squareback		000 051 324	service kit	universal votex	1	
	1J0 035 234 A	bracket for cd-changer to be used for: as required use:	side 1J6 035 111 N 090 178.2	1	PASSAT 98> squareback			installat. kit for cd-player comprising: loom bracket fitting instructions	1H0 035 111		
	3B9 035 112 B	bracket for vehicles without navigation system for cd changer	genuine vw 1J6 035 111	1	PASSAT 98> squareback		000 051 324 A	service kit installat. kit for cd-player to be used for:	universal votex 1J6 035 111	1	
		installat. kit for cd-player						comprising: loom bracket fitting instructions			
								further parts			
						-	8A0 051 445	loom only for:	VOTEX 445 035 225	1	
						-	000 051 440 B	adapter DIN/CINCH	0,2M BLAUPUNKT	1	

Model	Year	MG	SG	Illustration	VIN No.	Update	15:19	18.02.20100		ETKA	
ZPA	90	0	01	1-04		336					



Pos	Part Number	Name	Remarks	Qty	Model	Pos	Part Number	Name	Remarks	Qty	Model
-	000 051 440 C	cinch connection cable	1,3M BLAUPUNKT	1				length:	300MM		
-	000 051 440 D	cinch connection cable	5,0M BLAUPUNKT	1				install time:	5MIN		
-	000 051 178 A	adapter wiring loom for radio	BLAUPUNKT	1				to be used for:	000 051 209 E 000 051 209 F		
-	000 051 440	connection cable		1			000 051 443 B	connection cable	blaupunkt	1	
-	000 051 440 A	wiring	BLAUPUNKT only for: 000 051 440	1			.	.	26 pin		
	000 051 444 B	connection cable radio>amplifier	blaupunkt	1			.	bush (cinch)		4	
		bush (cinch)	36 pin	4			.	.	3,5MM		
		bush (iso)	6 pin					bush (iso)	10 pin		
		length: install time:	350MM 5MIN					length:			
	000 051 444 C	adapter radio>amplifier for car radio with connection block connector clutch amplifier connection cable	votex 30CM iso, 36-pin iso, 20-pin cinch / rca 5M	1 4				cinch connection cable	300MM 2000MM		
		length: install time:	30CM					install time:	20MIN		
	357 051 444 F	adapter active speaker for car radio with preamp output clutch connector	votex 30CM iso, 10-pin cinch / rca	1 4	VOLKSWAGEN AUDI	-	4A0 051 179 A	cd-magazine	only for: 000 051 209 E 000 051 209 F	1	
		length: install time:	30CM					replacement pt for 10 cd's		1	
		length: install time:	iso, 10-pin cinch / rca					to be used for:	000 051 209 J 000 051 209 K		
	357 051 444 G	adapter for connecting radios with preamp output radio>amplifier connector clutch amplifier connection cable	votex 30CM iso, 10-pin iso, 10-pin cinch / rca 5M	1 4			0B0 051 179	cd-magazine	replacement pt for 10 cd's	1	
		length: install time:	30CM					to be used for:	0B0 051 209		
	000 051 735	connection cable radio>cd changer	blaupunkt	1			0S0 051 179	cd-magazine	replacement pt for 10 cd's	1	
		length: install time:	36 pin					to be used for:	0S0 051 209		
		bush (cinch)		2							
		bush (iso)	8 pin								

Model	Year	MG	SG	Illustration	VIN No.	Update	15:19	18.02.20100		ETKA	
ZPA	90	0	01	1-05		336					



Pos	Part Number	Name	Remarks	Qty	Model
		loudspeaker set			
	3B0 035 606	loudspeaker set comprising: treble loudspeaker woofer securing parts loom for loudspeaker mounting instructions for serv. install. use:	rear door genuine vw 3B0 035 411 A 3B0 035 217 B	1 2 2 1	PASSAT 97> PASSAT VARIANT 98>
	3B0 035 608	loudspeaker set comprising: woofer treble loudspeaker loom for loudspeaker mounting instructions for serv. install. use:	front door genuine vw 3B0 035 411 A 3B0 035 217 A	1 2 2 1	PASSAT 97> PASSAT VARIANT 98>
-	Z 051 500	loudspeaker set comprising: DUAL CONE-LAUTSPRECHER loom for loudspeaker fitting instructions	'GL 151' 90X150 2X25W/4 OHM 50-20 000 HZ rear fitting	1	VARIANT 88>
-	Z 051 471	loudspeaker set comprising: 2 WEGE-LAUTSPRECHER loom for loudspeaker mounting instructions	'GL 600' 90X150 30 WATT 50-22 000 HZ 4 OHM rear fitting	1	VARIANT 88>
	333 051 606 A	loudspeaker set comprising: two-way speaker loom for loudspeaker complete with fitting instructions and fitting material	rear fitting votex	1	PASSAT 88>93 squareback 88>93
-	535 051 150	loudspeaker set	'IC 109' BLAUPUNKT rear fitting	1	PASSAT 88>93 PASSAT VARIANT 88>93
	1H6 051 323	fitting kit for subwoofer to be used for:	votex 1H0 051 606	1	
	1H6 051 323 B	installation set for subwoofer comprising: bracket securing parts cable set	votex 1H0 051 606 PLUG & PLAY	1	PASSAT squareback 88>96

Model	Year	MG	SG	Illustration	VIN No.	Update	15:19	18.02.20100		ETKA	
ZPA	90	0	01	1-05		336					



Pos	Part Number	Name	Remarks	Qty	Model	Pos	Part Number	Name	Remarks	Qty	Model
-	3A0 035 609	loudspeaker set comprising: broadband loudspeaker cable set complete with fitting instructions and fitting material	dash panel genuine vw 707 035 403	1	PASSAT 88> PASSAT VARIANT 88>		1H0 051 608 B	loudspeaker set 3-way system two-way speaker woofer as required use: . . .	dash panel doors front upgrading kit 6N0 051 411 3A0 051 411 A	1	PASSAT 93>96 PASSAT squareback 93>96
	1H0 051 609	loudspeaker set comprising: dual cone speaker loom for loudspeaker complete with fitting instructions and fitting material	dash panel votex 1H0 051 403	1	PASSAT 88> PASSAT VARIANT 88>		3A0 051 609	loudspeaker loudspeaker set comprising: treble loudspeaker loom for loudspeaker complete with fitting instructions and fitting material	dash panel upgrading kit votex 3A0 051 411	1	PASSAT 88>96 squareback 88>96
	1H0 051 403	loudspeaker dual cone speaker from the kit:	dash panel votex 1H0 051 609	1						2 1	
-	357 051 150	loudspeaker set	'IC 102' BLAUPUNKT dash panel	1	PASSAT 88> PASSAT VARIANT 88>		3A0 051 411	loudspeaker treble loudspeaker from the kit:	dash panel votex 3A0 051 609	1	PASSAT 88>96 squareback 88>96
-	Z 051 614	loudspeaker set comprising: DUAL CONE-LAUTSPRECHER loom for loudspeaker securing parts mounting instructions	'HL 511' 100 MM 50 WATT 50-20 000 HZ 4 OHM FUER: dash panel	1	PASSAT 94> VARIANT 94>		3A0 051 608	loudspeaker loudspeaker set comprising: woofer loom for loudspeaker as required use: loudspeaker frame loudspeaker grille	upgrading kit front / rear doors votex 3A0 051 411 A	1	PASSAT 94>96 squareback 94>96
-	Z 051 605	loudspeaker set comprising: 2X 160MM TIEFTOENER 2X 100MM KALOTTENHOCHTOENER KABELSATZ/FREQUENZWEICHE BEFESTIGUNGSMATERIAL mounting instructions	'CS-355' 120 WATT 30-25 000 HZ 4 OHM FUER: door pockets dash panel	1	PASSAT 94> VARIANT 94>		3A0 051 411 A	loudspeaker woofer from the kit:	votex 3A0 051 608	1	PASSAT 94>96 squareback 94>96
	6N0 051 609	loudspeaker loudspeaker set comprising: two-way speaker loom for loudspeaker complete with fitting instructions and fitting material	dash panel upgrading kit votex 6N0 051 411	1 2 1	PASSAT 88>96 squareback 88>96	-	1H0 051 403 A	loudspeaker NUR FUER:	dash panel 1H0 051 608 A	1	
	6N0 051 411	loudspeaker two-way speaker from the kit:	dash panel votex 6N0 051 609	1	PASSAT 88>96 squareback 88>96		1H4 051 606	installation set loudspeaker set comprising: woofer treble loudspeaker loom for loudspeaker complete with fitting instructions and fitting material	rear doors 4 doors votex 1H0 051 411 A 1H6 051 411	1	PASSAT 94> VARIANT 94>
-	1H0 051 608	loudspeaker set comprising: woofer treble loudspeaker	door pockets dash panel	1	PASSAT 94> PASSAT VARIANT 94>					2 2 1	

Model	Year	MG	SG	Illustration	VIN No.	Update	15:19	18.02.20100		ETKA	
ZPA	90	0	01	1-05		336					



Pos	Part Number	Name	Remarks	Qty	Model	Pos	Part Number	Name	Remarks	Qty	Model
	1H6 051 411	loudspeaker trebble loudspeaker	rear doors replacement pt 4 doors votex from the kit: 1H4 051 606	1	PASSAT 94> VARIANT 94>	-	Z 051 516	loudspeaker comprising: 2-WEGE-SYSTEM MIT INTEGRIERTEM HOCHTOENER BLENDEN UND KABEL EINBAUSCHABLONE	'JR 404' 130 MM SCHRAUBBEFEST. 75 WATT 45-20 000 HZ 4 OHM	1	
	1H0 051 411 A	loudspeaker woofer	rear doors votex only for: 1H4 051 606 for models with: door pockets trim genuine vw	1	PASSAT 94> VARIANT 94>	-	Z 051 517	loudspeaker comprising: 2-WEGE-SYSTEM MIT INTEGRIERTEM HOCHTOENER BLENDEN UND KABEL EINBAUSCHABLONE	'JR 707' 90X150 MM SCHRAUBBEFEST. 70 WATT 50-20 000 HZ 4 OHM	1	
	1H6 051 323 B	installation set for subwoofer comprising: bracket securing parts cable set	votex 1H0 051 606 PLUG & PLAY	1	PASSAT squareback 88>96	-	Z 051 518	loudspeaker comprising: 3-WEGE-SYSTEM MIT BLENDEN loom for loudspeaker mounting instructions	'SR-X 360' 160 MM SCHRAUBBEFEST. 90 WATT 40-18 000 HZ 4 OHM	1	
-	Z 051 913	loudspeaker 2-WEGE-COMP.	'PRS 106I' PHILIPS 165/25 120/50 WATT 30-25 000 HZ 4 OHM	1	PASSAT 88>93 squareback 88>93	-	Z 051 519	loudspeaker comprising: 3-WEGE-SYSTEM MIT INTEGRIERTEM HOCHTOENER UND MITTELTOENER BLENDEN UND KABEL EINBAUSCHABLONE	'JR 606' 160 MM SCHRAUBBEFEST. 150 WATT 35-22 000 HZ 4 OHM	1	
-	Z 051 618	loudspeaker set comprising: 2X160 MM BAßLAUTSPRECHER 2X100 MM HOCHTONLAUTSPRECHER loom for loudspeaker mounting instructions	'CS 390' 120 WATT 30-25 000 HZ 4 OHM FUER: dash panel front door	1	PASSAT 88>93 PASSAT VARIANT 88>93	-	Z 051 520	loudspeaker comprising: 3-WEGE-SYSTEM MIT INTEGRIERTEM HOCHTOENER UND MITTELTOENER BLENDEN UND KABEL EINBAUSCHABLONE	'JR 910' 150X230 MM SCHRAUBBEFEST. 250 WATT 35-22 000 HZ 4 OHM	1	
-	1H5 051 606	loudspeaker set 2-way system for vehicles with airbag	rear shelf door pockets votex	1	PASSAT 88>	-	Z 051 607	safety restraint system for sound boards NACHRUESTSATZ	FUER: HECKKLAPPE	1	
-	Z 051 635	loudspeaker set comprising: DUAL CONE-LAUTSPRECHER loom for loudspeaker mounting instructions	'GL 150' 2X25W/4 OHM FUER: dash panel	1		-	Z 051 633	loudspeaker set comprising: DUAL CONE-LAUTSPRECHER MIT FESTER BLENDE loom for loudspeaker mounting instructions	'SR 120' 120 MM 30 WATT 50-20 000 HZ 4 OHM	1	
-	Z 051 515	loudspeaker comprising: 2-WEGE-SYSTEM MIT INTEGRIERTEM HOCHTOENER BLENDEN UND KABEL EINBAUSCHABLONE	'JR 202' 100 MM SCHRAUBBEFEST. 60 WATT 50-20 000 HZ 4 OHM	1		-	Z 051 847	loudspeaker 2-WEGE COAXIAL	'GTM 1020' PHILIPS 100 MM 60 WATT 45-25 000 HZ	1	

Model	Year	MG	SG	Illustration	VIN No.	Update	15:19	18.02.20100		ETKA	
ZPA	90	0	01	1-05		336					



Pos	Part Number	Name	Remarks	Qty	Model	Pos	Part Number	Name	Remarks	Qty	Model
-	Z 051 848	loudspeaker 2-WEGE COAXIAL	'GTM 1320' PHILIPS 130 MM 80 WATT 45-25 000 HZ	1			000 051 149	loudspeaker	SUBWOOFER 'XLW 300' BLAUPUNKT as required use: 000 051 149 A	1	
-	Z 051 852	loudspeaker 2-WEGE COAXIAL	'GTM 1720' PHILIPS 165 MM 90 WATT 30-25 000 HZ	1			000 051 149 A	cover	to be used for: plus part blaupunkt 000 051 149	1	
-	Z 051 867	loudspeaker 2-WEGE-COMP.-SYSTEM BAÑ-/MITTENTOENER 100 MM SEIDEN-KALOTTEN-HOCHT. 25 MM	'PRS 1050' PHILIPS 70 WATT 40-25 000 HZ	1		-	000 051 150	loudspeaker set woofer	'CAR MAGIC 231' BLAUPUNKT	1	
-	Z 051 868	loudspeaker 2-WEGE-COMP.-SYSTEM BAÑ-/MITTENTOENER 130 MM SEIDEN-KALOTTEN-HOCHT. 25 MM	'PRS 1350' PHILIPS 90 WATT 40-25 000 HZ	1		-	000 051 151 B	loudspeaker set	'AL 100' BLAUPUNKT	1	
-	Z 051 889	loudspeaker 2-WEGE-COMP.-SYSTEM BAÑ-/MITTENTOENER 165 MM SEIDEN-KALOTTEN-HOCHT. 25 MM	'PRS 1750' PHILIPS 120 WATT 30-25 000 HZ	1		-	000 051 152 A	loudspeaker set	'AL 120' BLAUPUNKT	1	
-	357 051 608	loudspeaker set comprising: treble loudspeaker woofer	dash panel door pockets front	1	PASSAT 88>93 VARIANT 88>93		000 051 154 B	loudspeaker set	'CX 130' blaupunkt	1	
-	357 051 608	loudspeaker set comprising: treble loudspeaker woofer	dash panel door pockets front	1	PASSAT 88>93 VARIANT 88>93		000 051 155 B	loudspeaker set	'CX 170' blaupunkt	1	
-	535 051 150 B	loudspeaker kit	'INCAR 109' BLAUPUNKT rear fitting	1	VARIANT 88>	-	000 051 155 A	loudspeaker	'XL 170' BLAUPUNKT	1	
	357 051 150 A	loudspeaker kit loudspeaker set comprising: dual cone speaker loom for loudspeaker complete with fitting instructions and fitting material	dash panel IC 102 blaupunkt	1	PASSAT 88>96 squareback 88>96						
	000 051 150 A	loudspeaker	SUBWOOFER 'XLT 200' BLAUPUNKT	1							

Model	Year	MG	SG	Illustration	VIN No.	Update	15:20	18.02.20100		ETKA	
ZPA	90	0	01	1-06		336					



Pos	Part Number	Name	Remarks	Qty	Model
		replacement speaker for factory-fitted audio systems			
		replacement loudspeaker			88>93
	357 035 403 B	loudspeaker treble loudspeaker to be used for: diameter:	dash panel replacement pt VW GAMMA VW GAMMA CD 100MM	1	PASSAT 88>93 notchback squareback
	357 035 403 F	loudspeaker treble loudspeaker to be used for: diameter:	dash panel replacement pt VW BETA VW GAMMA radio pre-inst 100MM	1	PASSAT 88>93 notchback squareback
	707 035 403	loudspeaker broadband loudspeaker to be used for: diameter:	dash panel genuine vw VW ALPHA 100MM	1	PASSAT 88>93 notchback squareback
	357 035 403	loudspeaker active speaker to be used for: diameter:	front door replacement pt VW GAMMA VW GAMMA CD 160MM	1	PASSAT 88>93 notchback squareback
	357 035 411 D	loudspeaker broadband loudspeaker only for: taxi equipment police vehicles diameter:	front door	1	PASSAT 88>93 notchback squareback
	357 035 411 H	loudspeaker woofer to be used for: diameter:	front door replacement pt VW BETA VW GAMMA radio pre-inst 160MM	1	PASSAT 88>93 notchback squareback
	357 035 403 D	loudspeaker active speaker to be used for:	front left VW GAMMA VW GAMMA CD	1	PASSAT 1/89>2/90
	357 035 404	loudspeaker active speaker to be used for:	front right VW GAMMA VW GAMMA CD	1	PASSAT 1/89>2/90

Model	Year	MG	SG	Illustration	VIN No.	Update	15:20	18.02.20100		ETKA	
ZPA	90	0	01	1-06		336					



Pos	Part Number	Name	Remarks	Qty	Model	Pos	Part Number	Name	Remarks	Qty	Model
	357 035 403 G	loudspeaker active speaker to be used for:	front door left VW GAMMA VW GAMMA CD	1	PASSAT notchback 3/90>93		8/87 7/93 01C	black replacement loudspeaker			94>96
	357 035 404 A	loudspeaker active speaker to be used for:	front door right VW GAMMA VW GAMMA CD	1	PASSAT notchback 3/90>93		707 035 403	loudspeaker broadband loudspeaker to be used for: diameter:	dash panel genuine vw VW ALPHA 100MM	1	PASSAT 94>96 notchback squareback
	357 035 403 G	loudspeaker active speaker to be used for:	front door left VW GAMMA VW GAMMA CD	1	PASSAT squareback 3/90>8/92		1H0 035 411 A	loudspeaker woofer to be used for: diameter:	genuine vw doors front rear doors VW BETA VW GAMMA radio pre-inst 168MM	1	PASSAT 94>96 notchback squareback
	357 035 404 A	loudspeaker active speaker to be used for:	front door right VW GAMMA VW GAMMA CD	1	PASSAT squareback 3/90>8/92		1H0 035 411 D	loudspeaker trebble loudspeaker diameter: frequencies:	dash panel replacement pt 25/50 WATT 100MM 2500-20000HZ	1	PASSAT 94>96 notchback squareback
	333 035 403	loudspeaker active speaker to be used for:	front door left VW GAMMA VW GAMMA CD	1	PASSAT 9/92>93 squareback			use for:	VW BETA VW GAMMA radio pre-inst		
	333 035 404	bass reflex box active speaker to be used for:	front door right VW GAMMA VW GAMMA CD	1	PASSAT 9/92>93 squareback		1H0 035 411 D	loudspeaker trebble loudspeaker diameter: frequencies:	dash panel replacement pt 25/50 WATT 100MM 2500-20000HZ	1	PASSAT 94>96 notchback squareback
	357 035 411 E	loudspeaker broadband loudspeaker to be used for: diameter:	rear shelf replacement pt VW GAMMA VW GAMMA CD 130MM	1	PASSAT 1/89>93 notchback		3A0 035 407 B	loudspeaker trebble loudspeaker for vehicles without electri- cally operated windows to be used for:	left rear 4 doors replacement pt genuine vw VW GAMMA radio pre-inst 25/50 WATT 25 MM >>324KHZ	1	PASSAT 94>96 notchback squareback
	357 035 411 E	loudspeaker broadband loudspeaker to be used for: diameter:	rear shelf replacement pt VW GAMMA VW GAMMA CD 130MM	1	PASSAT 1/89>93 notchback						
	333 035 411 B	loudspeaker broadband loudspeaker to be used for:	rear shelf replacement pt 10/15 WATT VW BETA VW GAMMA radio pre-inst	1	PASSAT 88>93 squareback		8/93 7/96 A94	satin black			
	357 035 411	loudspeaker broadband loudspeaker to be used for: diameter:	replacement pt rear shelf VW GAMMA VW GAMMA CD radio pre-inst 130MM	2	PASSAT 88>93 notchback		8/93 7/96 E64	platinum			
							8/93 7/96 G54	mauritius blue			
							8/93 7/96 R24	sahara			

Model	Year	MG	SG	Illustration	VIN No.	Update	15:20	18.02.20100		ETKA	
ZPA	90	0	01	1-06		336					



Pos	Part Number	Name	Remarks	Qty	Model	Pos	Part Number	Name	Remarks	Qty	Model
	3A0 035 408 B	loudspeaker treble loudspeaker for vehicles without electrically operated windows to be used for:	rear door right replacement pt genuine vw VW GAMMA radio pre-inst 25/50 WATT 25 MM 3>24 KHZ	1	PASSAT 94>96 notchback squareback		3B0 060 974 E	loudspeaker treble loudspeaker to be used for: with mirror triangle to be used for:	front door right genuine vw 1J0 035 608 VW BETA VW GAMMA radio pre-inst	1	PASSAT 97> PASSAT VARIANT 98>
	8/93 7/96 A94	satin black					3B0 060 974 E	loudspeaker treble loudspeaker to be used for: with mirror triangle to be used for:	front door right genuine vw 1J0 035 608 VW BETA VW GAMMA radio pre-inst	1	PASSAT 97> PASSAT VARIANT 98>
	8/93 7/96 E64	platinum					3B0 035 411 G	loudspeaker woofer diameter: frequencies: to be used for:	front / rear doors 168MM 20/40W 60-2000HZ VW BETA VW GAMMA radio pre-inst	1	PASSAT LIM. 97> VAR. 98>
	8/93 7/96 G54	mauritius blue					3B0 060 113 AE	loudspeaker treble loudspeaker for vehicles without electrically operated windows diameter: frequencies:	rear door left genuine vw 19MM 20/30 WATT 2000-20000HZ	1	PASSAT LIM.97> VAR.98>
	8/93 7/96 R24	sahara					10/96 2AQ	black			
	8/93 7/96 A94	satin black					10/96 4ET	platinum			
	8/93 7/96 E64	platinum					3B0 060 114 AE	loudspeaker treble loudspeaker for vehicles without electrically operated windows diameter: frequencies:	rear door right genuine vw 19MM 20/30 WATT 2000-20000HZ	1	PASSAT LIM.97> VAR.98>
	8/93 7/96 G54	mauritius blue					10/96 2AQ	black			
	8/93 7/96 R24	sahara beige					10/96 4ET	platinum			
		replacement loudspeaker			97>		10/96 2AQ	black			
	3A0 035 408 C	loudspeaker treble loudspeaker for vehicles with electrically operated windows	right rear 4 doors	1	PASSAT 94>96 notchback squareback		10/96 4ET	platinum			
	8/93 7/96 A94	satin black					10/96 2AQ	black			
	8/93 7/96 E64	platinum					10/96 4ET	platinum			
	8/93 7/96 G54	mauritius blue					10/96 2AQ	black			
	8/93 7/96 R24	sahara beige					10/96 4ET	platinum			
	3B0 060 973 E	loudspeaker treble loudspeaker to be used for: with mirror triangle to be used for:	front door left genuine vw 1J0 035 608 VW BETA VW GAMMA radio pre-inst	1	PASSAT 97> PASSAT VARIANT 98>						

Model	Year	MG	SG	Illustration	VIN No.	Update	15:20	18.02.20100		ETKA	
ZPA	90	0	01	1-06		336					



Pos	Part Number	Name	Remarks	Qty	Model	Pos	Part Number	Name	Remarks	Qty	Model
	3B0 060 114 AJ	loudspeaker treble loudspeaker for vehicles with electrically operated windows	rear door right genuine vw	1	PASSAT LIM.97> VAR.98>						
		diameter:	19MM								
		frequencies:	20/30 WATT 2000-20000HZ								
	10/96	2AQ	black								
	10/96	4ET	platinum								

Model	Year	MG	SG	Illustration	VIN No.	Update	15:20	18.02.20100		ETKA	
ZPA	90	0	01	1-07		336					



Pos	Part Number	Name	Remarks	Qty	Model
-	3A0 035 241	accessories for speakers, faders bracket woofer	only for: front left door	1	PASSAT 94> PASSAT squareback 94>
	3A0 035 241	bracket loudspeaker frame	front door left genuine vw	1	PASSAT / VARIANT 94>
	3A0 035 241 A	bracket loudspeaker frame	rear door left genuine vw	1	PASSAT / VARIANT 94>
	3A0 035 242	bracket loudspeaker frame	front door right genuine vw	1	PASSAT / VARIANT 94>
	3A0 035 242 A	bracket loudspeaker frame	rear door right genuine vw	1	PASSAT / VARIANT 94>
	3B0 035 217	loudspeaker frame use for: woofer	front / rear doors genuine vw 3B0 035 411 A	1	PASSAT 97> PASSAT VARIANT 97>
	1H6 051 323 B	installation set for subwoofer comprising: bracket securing parts cable set	votex 1H0 051 606 PLUG & PLAY	1	PASSAT squareback 88>96
-	Z 051 472	spacers for window crank	black plastic 1 set = 2 parts	1	
	1H4 060 737	loom for loudspeaker for vehicles with airbag		1	

Model	Year	MG	SG	Illustration	VIN No.	Update	15:20	18.02.20100		ETKA	
ZPA	90	0	01	1-08		336					



Pos	Part Number	Name	Remarks	Qty	Model
		loom for loudspeaker			
	3A0 035 439	loom for loudspeaker	replacement pt genuine vw	1	PASSAT 94>96
		radio>dash panel			
		to be used for:	VW ALPHA		PASSAT
		number per vehicle:	1		squareback 94>96
	3A0 035 439 D	cable set	replacement pt	1	PASSAT
		radio>dash panel	genuine vw		94>96
		use for:	VW BETA		PASSAT
			VW GAMMA		squareback
		number per vehicle:		1	94>96
		coupling for speaker	left/right		
		connection (a/b pillar)			
	3A0 035 440 G	loom for loudspeaker	replacement pt genuine vw	1	PASSAT 94>96
		a pillar>b pillar			
		to be used for:	VW GAMMA		PASSAT
		number per vehicle:		2	squareback 94>96
		coupling adapter	for:		
			3A0 035 439 D		
	3A0 035 440 D	loom for loudspeaker	replacement pt genuine vw	1	PASSAT 94>96
		dash panel>a pillar			
		to be used for:	VW BETA		PASSAT
			VW GAMMA		squareback 94>96
		number per vehicle:		2	

Model	Year	MG	SG	Illustration	VIN No.	Update	15:20	18.02.20100		ETKA	
ZPA	90	0	01	1-10		336					



Pos	Part Number	Name	Remarks	Qty	Model
		retractable aerial -----			
	165 051 503 A	retractable aerial aerial wire bracket fitting instructions grommet	with: 770MM 50 OHM genuine vw 3-part also use: 311 611 743	1	PASSAT fastback 10/80>3/88 squareback 11/80>3/88 8/87>
	8/74 01C	black chromed			
-	357 051 503	retractable aerial	50 OHM stainlss steel 4-part	1	PASSAT notchback 88>93
-	Z 051 803	retractable aerial EDELSTAHL ROSTFREI	7-TEILIG lockable TIEFE 19CM KABEL 140CM	1	PASSAT >87 PASSAT fastback 81>88 PASSAT VARIANT >87
-	Z 051 806	retractable aerial EDELSTAHL ROSTFREI	4-part lockable TIEFE 25CM KABEL 140CM	1	PASSAT >87 PASSAT fastback 81>88 PASSAT VARIANT >87
-	Z 051 533	retractable aerial EDELSTAHL ROSTFREI	4-part lockable TIEFE 27CM TELESKOP 90CM wing for attaching:	1	PASSAT notchback 88>93 PASSAT 88>93
-	000 051 515	retractable aerial	150 OHM 4-part stainlss steel	1	PASSAT >80 PASSAT VARIANT >80
-	Z 051 800	retractable aerial	black chromed 4-part lockable TIEFE 25CM KABEL 140CM	1	PASSAT >87 PASSAT fastback 81>88
-	Z 051 534	retractable aerial for fender	black chromed 4-part lockable TIEFE 27CM KABEL 140CM TELESKOP 90CM	1	PASSAT notchback 89>93 PASSAT squareback 88>93

Model	Year	MG	SG	Illustration	VIN No.	Update	15:21	18.02.20100		ETKA	
ZPA	90	0	01	1-11		336					



Pos	Part Number	Name	Remarks	Qty	Model
		power-operated aerial			
	000 051 509 A	power-operated aerial service kit complete with fitting instructions and fitting material as required use: aerial telescope	150 OHM stainlss steel left front votex	1	PASSAT 84>91 PASSAT VARIANT >87
-	823 051 561	aerial telescope	for: 000 051 509 B	1	PASSAT 84>91 VARIANT >87
-	Z 051 525	power-operated aerial VOLLAUTOMATISCH	'TE 780' 150 OHM stainlss steel 90 CM EINBAUTIEFE: 27 CM BOHRLOCH DURCHMESSER: 16 MM LINKS VORNE Z 051 527	1	PASSAT 84>91 VARIANT >87
-	Z 051 527	aerial telescope	'TE 784' 90 CM stainlss steel only for: Z 051 525 Z 051 865	1	
-	Z 051 810	power-operated aerial	'TE 785' 150 OHM left front	1	PASSAT 84>91 PASSAT VARIANT >87
-	Z 051 812	aerial telescope	'TE 788' only for: Z 051 810 Z 051 854 Z 051 866	1	
-	Z 051 853	power-operated aerial for vehicles without air conditioner	'TE 680' 150 OHM left front	1	PASSAT 88>93 PASSAT squareback 88>93
-	Z 051 854	power-operated aerial for vehicles without air conditioner	'TE 685' 150 OHM left front	1	PASSAT 88>93 PASSAT squareback 88>93
-	Z 051 854	power-operated aerial for vehicles without air conditioner	'TE 685' 150 OHM left front	1	PASSAT 88>93 PASSAT squareback 88>93

Model	Year	MG	SG	Illustration	VIN No.	Update	15:21	18.02.20100		ETKA	
ZPA	90	0	01	1-12		336					



Pos	Part Number	Name	Remarks	Qty	Model
		special aerials			
	871 035 503	electronic roof aerial with seperate power supply for car radio (screw connection) aerial booster rod-type aerial aerial base lock nut	75 OHM replacement pt integrated 3A0 051 849	1	PASSAT 88>93 sedan squareback
	3A0 035 505 C	roof antenna with twin plug rod-type aerial aerial base aerial booster lock nut	75 OHM remote-feed replacement pt 3A0 051 849 integrated	1	PASSAT LIM. 94>96 VAR. 94>97
	3B0 035 505	electronic roof aerial with remote feed booster aerial base rod-type aerial lock nut	75 OHM genuine vw FM/AM integrated 3A0 051 849	1	PASSAT LIM. 97>98 VAR. 98>98
	1J0 035 505 A	roof antenna with twin plug as required use: rod-type aerial	remote-feed genuine vw 3A0 051 849	1	PASSAT LIM. 99> VAR. 99>
	1H0 051 503 B	antenna for car radio rod-type aerial with twin plug with seperate power supply aerial booster cable angled connector	75 OHM '16 V' 3A0 051 849 integrated	1	
	000 051 504 C	electronic roof aerial with seperate power supply for car radio rod-type aerial aerial booster connection cable coaxial connector	5500MM 150 OHM 16V retrofit part 3A0 051 849 integrated	1	
	000 051 577	screen aerial fitting: bonding aerial wire complete with fitting instruc- tions and fitting material	'AUTOFUN' BOSCH	1	
-	Z 051 858	aerial telescope		1	

Model	Year	MG	SG	Illustration	VIN No.	Update	15:21	18.02.20100		ETKA	
ZPA	90	0	01	1-12		336					



Pos	Part Number	Name	Remarks	Qty	Model	Pos	Part Number	Name	Remarks	Qty	Model
	3A0 051 849	rod-type aerial for car radio	450MM black replacement pt	1							

Model	Year	MG	SG	Illustration	VIN No.	Update	15:21	18.02.20100		ETKA	
ZPA	90	0	01	1-13		336					



Pos	Part Number	Name	Remarks	Qty	Model
		aerial booster	replacement pt		
	357 035 577 A	converter use for: screen aerial as required use:	75 OHM replacement pt 357 035 570 A 357 035 583 33 035 583	1	PASSAT 88>93 sedan squareback
	357 035 570 A	converter blocking circuit as required use: use for: screen aerial	357 035 577 A	1	PASSAT 88>93 sedan squareback
	357 035 583	connection cable amplifier>windscreen use for:	357 035 577 A	1	PASSAT 88>93 sedan
	333 035 583	connection cable amplifier>windscreen use for:	357 035 577 A	1	PASSAT 88>93 squareback
		accessories for radio aerials			
-	000 051 537	adapter coaxial connector cable angled connector		1	
-	191 035 551	adapter cable angled connector coaxial connector		1	
	1H0 035 551	adapter for remote feed aerial for connecting radios without remote feed cable angled connector	75 OHM	1	92>
	1H0 051 551	adapter for remote feed aerial for connecting radios without remote feed cable angled connector	75 OHM VOTEX	1	92>
-	3A0 035 550 B	adapter cable KOMBIANTENNE AN ANTENNENWEICHE BEI police vehicles		1	PASSAT 94>
-	3A0 035 551	adapter HF-LEITUNG AN ANTENNENWEICHE BEI police vehicles		1	PASSAT 94>

Model	Year	MG	SG	Illustration	VIN No.	Update	15:21	18.02.20100		ETKA	
ZPA	90	0	01	1-13		336					



Pos	Part Number	Name	Remarks	Qty	Model	Pos	Part Number	Name	Remarks	Qty	Model
-	Z 051 859	adapter FUER ANTENNEN MIT HEROEMML. KOAXIALSTECKERN ZUM ANSCHLUSS AN GERAETE MIT NEUEM WINKELST. not for:	'ANT 48' 150 OHM QUICK-OUT	1			6K0 051 550	aerial wire diplexer>radio connections: votex angled plug M10X0,75	1500MM 75 OHM	1	
-	Z 051 834	adapter FUER ANTENNEN MIT NEUEM WINKEL STECKER AN RADIOS MIT HERKOEMM LICHER ANTENNEN-KOAXIALBUCHSE	'ANT 49'	1		-	1H0 051 760	relay only for:	VOTEX 1H0 051 509 357 051 509	1	
-	3A0 035 585 B	aerial filter taxi equipment only for:	3A0 035 505	1	PASSAT 94>	-	000 051 535	extension cable only for:	4300MM 000 051 532 000 051 534 B	1	
-	3A0 051 849 A	rod-type aerial taxi equipment only for:	3A0 035 505	1	PASSAT 94>	-	000 051 536	extension cable retractable aerial radio for installation in: bracket	50CM	1	
-	Z 051 527	aerial telescope only for:	'TE 784' Z 051 525 Z 051 853 Z 051 865	1		-	Z 051 814	extension cable MIT VERKUEERZUNGSKONDENSATOR	4700MM	1	
-	Z 051 812	aerial telescope only for:	'TE 788' Z 051 810 Z 051 854 Z 051 866	1		-	Z 051 815	extension cable MIT VERKUEERZUNGSKONDENSATOR	2000MM	1	
	3A0 051 849	rod-type aerial for car radio short rod aerial antenna to be used for:	450MM black replacement pt 1H0 051 503 B 3B0 035 505 3A0 035 505 B 3A0 035 505 C 871 035 503 000 051 504 C not for:	1			357 035 550 D	aerial wire aerial wire radio>amplifier use for: screen aerial with seperate power supply	genuine vw 6400MM 50 OHM replacement pt	1	PASSAT 88>93 sedan squareback
						-	3A9 035 550	aerial wire radio>roof use for: antenna	3250MM 75 OHM replacement pt remote-feed	1	PASSAT 94>96 sedan PASSAT 94>97 squareback
							3B2 035 550	aerial wire radio>tunnel use for: antenna	1020MM 75 OHM replacement pt remote-feed	1	PASSAT 97>98 sedan PASSAT 98>98 squareback
							3B1 035 550	aerial wire radio>tunnel use for: antenna	900MM 75 OHM remote-feed	1	PASSAT 99> PASSAT VARIANT 99>

Model	Year	MG	SG	Illustration	VIN No.	Update	15:21	18.02.20100		ETKA	
ZPA	90	0	01	1-13		336					



Pos	Part Number	Name	Remarks	Qty	Model	Pos	Part Number	Name	Remarks	Qty	Model
	3B5 035 550 B	aerial wire tunnel > aerial use for: antenna	4400MM 75 OHM replacement pt remote-feed	1	PASSAT 97> sedan						
	3B9 035 550 B	aerial wire tunnel > aerial use for: antenna	5200MM 75 OHM replacement pt remote-feed	1	PASSAT 98> squareback						

Model	Year	MG	SG	Illustration	VIN No.	Update	15:23	18.02.20100		ETKA	
ZPA	90	0	01	1-14		336					



Pos	Part Number	Name	Remarks	Qty	Model
		accessories for mobile phones for mobile phone	replacement pt		LIM. 97>98 VAR. 98>98
	3B0 035 704	mobile phone	gsm class 4 genuine vw transmit: 890-915MHZ receive: 935-960MHZ approval: FTA sim card format: SIM max. power: 2 WATT dimensions: 130X57X23MM	1	PASSAT 97> PASSAT VARIANT 98> >KW31/97
	#3B0 035 704 X	mobile phone (exchange part) the following are accepted for processing:	gsm/ d-network illumination,buttons/display: green genuine vw 3B0 035 704 AEG	1	PASSAT 97> PASSAT VARIANT 98>
	3B0 035 704 A	mobile phone	gsm class 4 genuine vw transmit: 890-915MHZ receive: 935-960MHZ approval: FTA sim card format: SIM max. power: 2 WATT illumination,buttons/display: blue/red	1	PASSAT 97> PASSAT VARIANT 98> KW 32/97>
	#3B0 035 704 AX	mobile phone (exchange part) the following are accepted for processing:	genuine vw 3B0 035 704 A AEG	1	PASSAT 97> PASSAT VARIANT 98> KW 32/97>
	8D0 060 407	fixture for mobile phone use for: mobile phone part not included in: mobile phone(preinstallation) part corresponds to:	genuine audi 3B0 035 704 gsm/ d-network 8D0 862 407	1	PASSAT 97> PASSAT VARIANT 98>

Model	Year	MG	SG	Illustration	VIN No.	Update	15:23	18.02.20100		ETKA	
ZPA	90	0	01	1-14		336					



Pos	Part Number	Name	Remarks	Qty	Model	Pos	Part Number	Name	Remarks	Qty	Model
	4A0 060 407 A	mobile phone cradle use for: mobile phone part not included in: mobile phone(preinstallation) part corresponds to:	genuine audi 3B0 035 704 gsm/ d-network 4A0 862 407 A	1	PASSAT 97> PASSAT VARIANT 98>		3B0 051 849	rod-type aerial use for: combinat. aerial (radio/phone)	genuine vw 3B0 035 505 A	1	PASSAT 97> PASSAT VARIANT 98>
	3B0 035 735	loom interface box>pillar a to be used for:	genuine vw 3B0 035 704	1	PASSAT 97> PASSAT VARIANT 98> >KW 31/97		3B0 035 507	roof combination aerial for simultaneous operation of radio,mobile phone,navigation frequencies: frequency diplexer: rod-type aerial	genuine vw AM/FM gsm/ d-network GPS integrated 3B0 051 849 A	1	PASSAT 97> LIM. 97>98 VAR. 98>98
	3B0 035 735 A	loom interface box>pillar a to be used for:	genuine vw right 3B0 035 704 A	1	PASSAT 97> PASSAT VARIANT 98> KW 32/97>		3B0 051 849 A	rod-type aerial use for: roof combination aerial for simultaneous operation of radio,mobile phone,navigation frequencies:	genuine vw 3B0 035 507 AM/FM gsm/ d-network GPS	1	
	8D0 060 387	mounting use for: connector handy>handy cable set part corresponds to: for mobile phone not in combination with: cassette holder	genuine audi 8D0 862 387 centre armrest	1	PASSAT 97> PASSAT VARIANT 98>		3B5 035 723	aerial wire interface box > aerial use for: interface box	genuine vw 4D0 060 335	1	PASSAT 97>
10/96 7/98 AQ4		satin black					3B9 035 723	aerial wire interface box > aerial use for: combinat. aerial (radio/phone)	genuine vw 3B0 035 505 A	1	PASSAT VARIANT 98>
	8D0 060 387 A	mounting use for: connector handy>handy cable set for mobile phone part corresponds to: only in combination with: cassette holder	genuine audi centre armrest 8D0 862 387 A	1	PASSAT 97> PASSAT VARIANT 98>		3B0 035 551	adapter for mobile phone interface > aerial wire		1	PASSAT 97> PASSAT VARIANT 98>
10/96 7/98 AQ4		satin black					3B0 035 551	adapter for mobile phone interface > aerial wire		1	PASSAT 97> PASSAT VARIANT 98>
	4D0 060 335	interface for mobile phone part not included in: mobile phone(preinstallation) part corresponds to:	genuine audi 4D0 862 335	1	PASSAT 97> PASSAT VARIANT 98>		3B0 035 711	microphone for hands-free facility use for: mobile phone	left genuine vw gsm/ d-network	1	PASSAT 97> PASSAT VARIANT 98>
	3B0 035 822	retainer use for: interface box part not included in: mobile phone(preinstallation)	genuine vw 4D0 035 335 gsm/ d-network	1	PASSAT 97> PASSAT VARIANT 98>		10/96 7/98 Y20	pearl grey			
	3B0 035 505 A	combinat. aerial (radio/phone) roof combination aerial as required use:	genuine vw 3B0 051 849	1	PASSAT 97> PASSAT VARIANT 98>		10/96 7/98 8YS	light beige			
							3B0 035 411 A	loudspeaker hands-off loudspeaker use for: pre-install.mobile phone/handy	front door left replacement pt genuine vw	1	PASSAT LIM. 97>98 VAR. 98>98

Model	Year	MG	SG	Illustration	VIN No.	Update	15:23	18.02.20100		ETKA	
ZPA	90	0	01	1-14		336					



Pos	Part Number	Name	Remarks	Qty	Model	Pos	Part Number	Name	Remarks	Qty	Model
	3B0 035 731	relay to switch from radio to phone use for: mobile phone	genuine vw 3B0 035 704	1	PASSAT LIM. 97>98 VAR. 98>98		4B0 060 413 A	fixture for mobile phone basic plate part not included in: mobile phone(preinstallation) part corresponds to:	replacement pt centre armrest 4B0 862 413 A	1	PASSAT LIM. 99> VAR. 99>
	4A0 051 643	mating connector for vda connector with: contact to connect handy's of various manufacturers to handy preinstallation	18 pin genuine vw genuine vw	1 18	PASSAT LIM. 97>98 VAR. 98>98		4B0 060 415	button to be used for:	replacement pt 4B0 060 413 A	1	PASSAT LIM. 99> VAR. 99>
	7M0 035 727	flat contact housing for vda connector contact to connect handy's of various manufacturers to handy preinstallation	18 pin replacement pt genuine vw	1 18	PASSAT LIM. 97>98 VAR. 98>98		4B0 051 750 A	service kit to be used for: as required use:	replacement pt centre armrest 4B0 060 413 A 4B0 060 415	1	PASSAT LIM. 99> VAR. 99>
	1J0 035 551 A	adapter for installing combinat. aerial (radio/phone) for mobile phone	genuine vw gsm/ d-network 3B0 035 505 A 3B0 051 505 replacement pt	1	PASSAT 94>96 PASSAT squareback 94>96 LIM. 99> VAR. 99>		3B0 035 822	retainer use for: interface box part not included in: mobile phone(preinstallation)	replacement pt gsm/ d-network	1	LIM. 99> VAR. 99>
	4B0 035 703	mobile phone	replacement pt genuine audi	1	LIM. 99> VAR. 99>		1J0 035 505 C	combinat. aerial (radio/phone) roof combination aerial as required use:	gsm/ d-network replacement pt 3B0 051 849	1	LIM. 99> VAR. 99>
	4B0 035 747	rechargeable battery for mobile phone contained in:	replacement pt 4B0 035 703	1	LIM. 99> VAR. 99>		3B0 051 849	rod-type aerial use for: combinat. aerial (radio/phone)	replacement pt 1J0 035 505 C	1	LIM. 99> VAR. 99>
	4B0 035 743	plug-in power supply unit for mobile phone contained in:	replacement pt 4B0 035 703	1	LIM. 99> VAR. 99>		1J0 035 507	roof combination aerial for simultaneous operation of radio,mobile phone,navigation for vehicles with navigations- system ans integratet autoradio as required use:	replacement pt 3B0 051 849 A	1	PASSAT LIM. 99> VAR. 99>
	1J0 035 705 A	bracket mobile phone cradle to be used for: part not included in: mobile phone(preinstallation)	replacement pt 4B0 035 703	1	PASSAT LIM. 99> VAR. 99>		3B0 051 849 A	rod-type aerial roof combination aerial for simultaneous operation of radio,mobile phone,navigation frequencies:	genuine vw AM/FM gsm/ d-network GPS	1	PASSAT LIM. 99> VAR. 99>
	1J0 035 707	bracket fixture f. mobile phone cradle to be used for: part not included in: mobile phone(preinstallation)	replacement pt 1J0 035 705 A	1	PASSAT LIM. 99> VAR. 99>		3B9 035 723 C	aerial wire interface box > aerial connections: contained in: mobile phone(preinstallation)	4950MM RAKU2 WICLIC AK70	1	PASSAT LIM. 99> VAR. 99>

Model	Year	MG	SG	Illustration	VIN No.	Update	15:23	18.02.20100		ETKA	
ZPA	90	0	01	1-14		336					



Pos	Part Number	Name	Remarks	Qty	Model	Pos	Part Number	Name	Remarks	Qty	Model
	3B0 035 711	microphone for hands-free facility	pillar a	1	LIM.99>11/98 VAR.99>11/98		000 051 436 A	installation set for mobile phone	comfort vda standard to be used for: MOTOROLA 8200 MOTOROLA 8400 MOTOROLA 8700 also use: MOTOROLA FLARE	1	LIM. 97> VAR. 98>
	8/98 11/98 Y20	pearl grey									
	8/98 11/98 9YH	beige	beige								
	3B0 035 711 A	microphone for hands-free facility interior light use for: mobile phone	replacement pt genuine vw gsm/ d-network	1	PASSAT LIM. 12/98> VAR. 12/98>		000 051 436 B	installation set for mobile phone	comfort vda standard to be used for: NOKIA 2110 NOKIA 2110I also use:	1	LIM. 97> VAR. 98>
	12/98 B41	satin black									
	4A0 051 643	mating connector for vda connector mobile phone	18 pin replacement pt	1	LIM. 99> VAR. 99>		000 051 436 G	installation set for mobile phone	comfort vda standard to be used for: NOKIA 3110 also use:	1	LIM. 97> VAR. 98>
		contact	with:	18							
	7M0 035 727	flat contact housing for vda connector	18 pin replacement pt genuine vw	1	LIM. 99> VAR. 99>		000 051 436 N	installation set for mobile phone	comfort vda standard to be used for: NOKIA 5110 also use: NOKIA 6110	1	LIM. 97> VAR. 98>
		contact to connect handy's of various manufacturers to handy preinstallation		18							
		installation set for mobile phone for pre-installed vehicles	GSM 900 vda standard				000 051 436 C	installation set for mobile phone	comfort vda standard to be used for: NOKIA 8110 also use:	1	LIM. 97> VAR. 98>
	000 051 436	installation set for mobile phone to be used for: also use: mobile phone bracket	comfort vda standard ERICSSON GH337 ERICSSON GH388 1J1 051 601	1	LIM. 97> VAR. 98>		000 051 436 C	installation set for mobile phone to be used for: also use: mobile phone bracket	comfort vda standard NOKIA 8110 1J1 051 601	1	LIM. 97> VAR. 98>
	000 051 436 K	installation set for mobile phone to be used for: also use: mobile phone bracket	comfort vda standard ERICSSON GA628 ERICSSON GH688 1J1 051 601	1	LIM. 97> VAR. 98>		000 051 436 D	installation set for mobile phone to be used for: also use: mobile phone bracket	comfort vda standard SIEMENS S4	1	LIM. 97> VAR. 98>
	000 051 436 H	installation set for mobile phone to be used for: also use: mobile phone bracket	comfort vda standard ERICSSON GF788 1J1 051 601	1	LIM. 97> VAR. 98>		000 051 436 E	installation set for mobile phone to be used for: also use: mobile phone bracket	comfort vda standard SIEMENS S6	1	LIM. 97> VAR. 98>
							000 051 436 L	installation set for mobile phone to be used for: also use: mobile phone bracket	comfort vda standard SIEMENS S10 D	1	LIM. 97> VAR. 98>

Model	Year	MG	SG	Illustration	VIN No.	Update	15:23	18.02.20100		ETKA	
ZPA	90	0	01	1-14		336					



Pos	Part Number	Name	Remarks	Qty	Model	Pos	Part Number	Name	Remarks	Qty	Model
	000 051 436 M	installation set for mobile phone to be used for: also use: mobile phone bracket	comfort vda standard SIEMENS E10 D	1	LIM. 97> VAR. 98>		1J0 051 436 B	installation set for mobile phone to be used for: also use: mobile phone bracket	vda standard GSM 900/1800 NOKIA 5110 NOKIA 6110	1	LIM. 97> VAR. 98>
	000 051 436 F	installation set for mobile phone to be used for: also use: mobile phone bracket	comfort vda standard PHILIPS SPARK	1	LIM. 97> VAR. 98>		1J0 051 436 C	installation set for mobile phone to be used for: also use: mobile phone bracket for pre-installed vehicles	vda standard GSM 900/1800 SIEMENS S6 SIEMENS S6D SIEMENS S6E SIEMENS E10D	1	LIM. 97> VAR. 98>
	1J0 051 436 L	installation set for mobile phone to be used for: also use: mobile phone bracket	GSM 900/1800 vda standard	1	LIM. 97> VAR. 98>		1J0 051 436 D	installation set for mobile phone to be used for: also use: mobile phone bracket	vda standard GSM 900/1800 SIEMENS S10D SIEMENS S11E SONY CMD-X2000	1	LIM. 97> VAR. 98>
	1J0 051 436	installation set for mobile phone to be used for: also use: mobile phone bracket	vda standard GSM 900/1800 ERICSSON GA628 ERICSSON GH688 ERICSSON SH688	1	LIM. 97> VAR. 98>		1J0 051 436 G	installation set for mobile phone to be used for: also use: mobile phone bracket	vda standard GSM 900/1800 SIEMENS S10D ACTIVE	1	GOLF 98>
	1J0 051 436 M	installation set for mobile phone to be used for: also use: mobile phone bracket	vda standard GSM 900/1800 ALCATEL MOTOROLA CD920 MOTOROLA CD930	1	LIM. 97> VAR. 98>		1J0 051 436 E	installation set for mobile phone to be used for: also use: mobile phone bracket for pre-installed vehicles	vda standard GSM 900/1800 SIEMENS C10 SIEMENS C11	1	GOLF 98>
	1J0 051 436 N	installation set for mobile phone to be used for: also use: mobile phone bracket	vda standard GSM 900/1800 ALCATEL MOTOROLA CD520	1	LIM. 97> VAR. 98>		1J0 051 436 F	installation set for mobile phone to be used for: also use: mobile phone bracket	vda standard GSM 900/1800 SIEMENS S15 SIEMENS S16	1	LIM. 97> VAR. 98>
	1J0 051 436 A	installation set for mobile phone to be used for: also use: mobile phone bracket	vda standard GSM 900/1800 NOKIA 3110 NOKIA 8110	1	LIM. 97> VAR. 98>		1J0 051 436 H	installation set for mobile phone to be used for: also use: mobile phone bracket	vda standard GSM 900/1800 SONY Z1	1	LIM. 97> VAR. 98>

Model	Year	MG	SG	Illustration	VIN No.	Update	15:23	18.02.20100		ETKA	
ZPA	90	0	01	1-14		336					



Pos	Part Number	Name	Remarks	Qty	Model	Pos	Part Number	Name	Remarks	Qty	Model
	1J0 051 436 J	installation set for mobile phone to be used for:	vda standard GSM 900/1800 PANASONIC G450 PANASONIC G500	1	LIM. 97> VAR. 98>		000 051 438 J	installation set for mobile phone for veh. without pre-install. to be used for:	'KOMFORT' votex MOTOROLA 8700 MOTOROLA D460	1	
		also use: mobile phone bracket for pre-installed vehicles						mobile phone bracket antenna			
	1J0 051 436 K	installation set for mobile phone to be used for:	vda standard GSM 900/1800 PANASONIC G600	1	LIM. 97> VAR. 98>		000 051 438 B	installation set for mobile phone for veh. without pre-install. to be used for:	'KOMFORT' votex NOKIA 2110 NOKIA 2110I	1	
		also use: mobile phone bracket						mobile phone bracket antenna			
		installation set for mobile phone for veh. without pre-install.	GSM 900				000 051 438 G	installation set for mobile phone for veh. without pre-install. to be used for:	'KOMFORT' votex NOKIA 3110	1	
	000 051 438	installation set for mobile phone for veh. without pre-install. to be used for:	'KOMFORT' votex ERICSSON GH337 ERICSSON GA388	1				mobile phone bracket antenna			
		also use: mobile phone bracket antenna					000 051 438 N	installation set for mobile phone for veh. without pre-install. to be used for:	'KOMFORT' votex NOKIA 5110 NOKIA 6110	1	
	000 051 438 K	installation set for mobile phone for veh. without pre-install. to be used for:	'KOMFORT' votex ERICSSON GH688 ERICSSON GA628	1				mobile phone bracket antenna			
		also use: mobile phone bracket antenna					000 051 438 C	installation set for mobile phone for veh. without pre-install. to be used for:	'KOMFORT' votex NOKIA 8110	1	
	000 051 438 H	installation set for mobile phone for veh. without pre-install. to be used for:	'KOMFORT' votex ERICSSON GF788	1				antenna mobile phone bracket			
		also use: mobile phone bracket antenna					000 051 438 D	installation set for mobile phone for veh. without pre-install. to be used for:	'KOMFORT' votex SIEMENS S4	1	
	000 051 438 A	installation set for mobile phone for veh. without pre-install. to be used for:	'KOMFORT' votex MOTOROLA 8200 MOTOROLA 8400 MOTOROLA FLARE	1				antenna mobile phone bracket			
		also use: mobile phone bracket antenna					000 051 438 E	installation set for mobile phone for veh. without pre-install. to be used for:	'KOMFORT' votex SIEMENS S6	1	
								antenna mobile phone bracket			

Model	Year	MG	SG	Illustration	VIN No.	Update	15:23	18.02.20100		ETKA	
ZPA	90	0	01	1-14		336					



Pos	Part Number	Name	Remarks	Qty	Model	Pos	Part Number	Name	Remarks	Qty	Model
	000 051 438 L	installation set for mobile phone for veh. without pre-install. to be used for: also use: antenna mobile phone bracket	'KOMFORT' votex SIEMENS S10 D	1		10/96	B41	satin black			
	000 051 438 M	installation set for mobile phone for veh. without pre-install. to be used for: also use: antenna mobile phone bracket	'KOMFORT' votex SIEMENS E10 D	1		10/96	Q70	light beige			
	000 051 438 F	installation set for mobile phone for veh. without pre-install. to be used for: also use: antenna mobile phone bracket	'KOMFORT' votex PHILIPS SPARK	1		-	Z 051 068	charging cable		1	
	3A0 051 601	mobile phone bracket centre console	right VOTEX	1	LIM. 88>96 VAR. 88>97 lhd	-	Z 051 072	slim battery		1	
	8/87 9/96 01C	satin black				-	Z 051 071	power pack		1	
	3B1 051 601	mobile phone bracket also for: for vehicles with double airbag only in combination with: trim install time:	centre console right tuev-tested votex plastic aluminium 20MIN	1	PASSAT LIM. 97> VAR. 98> lhd	-	Z 051 019	aerial adapter		1	
	10/96	B41	satin black			-	Z 051 070	eliminator		1	
	10/96	Q70	light beige			-	Z 051 069	leather bag	black	1	
	10/96	U71	flannel grey			-	Z 051 016	aerial adapter	for: 'GH 172/174', 'D2 4041/4043' ERICSSON	1	
	3B1 051 601 A	mobile phone bracket also for: for vehicles with double airbag only in combination with: trim install time:	centre console right tuev-tested votex wood 20MIN	1	PASSAT LIM. 97> VAR. 98> lhd	-	Z 051 016	accessories	for: 'GH 197/198', ERICSSON	1	
						-	Z 051 055	active fixture	for: 'GH 197/198', ERICSSON	1	
						-	Z 051 049	charging cable		1	
						-	Z 051 054	slim battery		1	
						-	Z 051 053	power pack		1	
						-	Z 051 052	eliminator		1	

Model	Year	MG	SG	Illustration	VIN No.	Update	15:23	18.02.20100		ETKA	
ZPA	90	0	01	1-14		336					



Pos	Part Number	Name	Remarks	Qty	Model	Pos	Part Number	Name	Remarks	Qty	Model
-	Z 051 017	aerial adapter		1		-	Z 051 038	power pack		1	
-	Z 051 051	leather bag	for: 'GH 197' black	1		-	Z 051 037	eliminator		1	
-	Z 051 050	leather bag	for: 'GH 198' black	1		-	Z 051 014	aerial adapter		1	
-	Z 051 075	charging/discharging unit accessories	for: 'GH 337' ERICSSON	1		-	Z 051 035	leather bag	for: '5200' black	1	
-	Z 051 047	vehicle installation kit		1		-	Z 051 036	leather bag	for: '7200' black	1	
-	Z 051 048	active fixture		1		-	Z 051 077	charging/discharging unit	for: '5200'	1	
-	Z 051 042	charging cable		1		-	Z 051 078	charging/discharging unit	for: '7200'	1	
-	Z 051 046	slim battery		1		-	Z 051 078	charging/discharging unit	for: '7200'	1	
-	Z 051 045	eliminator		1				accessories	for: 'E-PLUS PT9' MOTOROLA		
-	Z 051 044	eliminator		1		-	Z 051 077	charging/discharging unit		1	
-	Z 051 015	aerial adapter		1				accessories	for: '1011' NOKIA and 'PR810' PHILIPS		
-	Z 051 043	leather bag	black	1		-	Z 051 027	active fixture		1	
-	Z 051 076	charging/discharging unit accessories	for: 'MT2000' HAGENUK	1		-	Z 051 029	charging cable		1	
-	Z 051 065	charging cable		1		-	Z 051 033	slim battery		1	
-	Z 051 067	eliminator		1		-	Z 051 032	power pack		1	
-	Z 051 066	leather bag accessories	black for: '5200/7200' MOTOROLA	1		-	Z 051 031	eliminator		1	
-	Z 051 040	vehicle installation kit		1		-	Z 051 018	aerial adapter		1	
-	Z 051 041	active fixture		1		-	Z 051 030	leather bag	black	1	
-	Z 051 034	charging cable		1		-	Z 051 079	charging/discharging unit	only for: '1011' NOKIA	1	
-	Z 051 039	slim battery		1							

Model	Year	MG	SG	Illustration	VIN No.	Update	15:23	18.02.20100		ETKA	
ZPA	90	0	01	1-14		336					



Pos	Part Number	Name	Remarks	Qty	Model	Pos	Part Number	Name	Remarks	Qty	Model
		accessories	for: '2110' NOKIA 'PR810' PHILIPS and 'E-PLUS PT11'			-	Z 051 060	power pack		1	
-	Z 051 025	vehicle installation kit		1		-	Z 051 060	power pack		1	
-	Z 051 026	active fixture		1		-	Z 051 059	eliminator		1	
-	Z 051 026	active fixture		1		-	Z 051 058	leather bag	black	1	
-	Z 051 021	charging cable		1		-	Z 051 081	charging/discharging unit	NUF FUER 'S3' SIEMENS	1	
-	Z 051 024	slim battery		1		-	Z 051 082	leather bag	black for: 'S4' SIEMENS	1	
-	Z 051 023	power pack		1		-	Z 051 083	mobile phone holder battery charger	for: 'S4' SIEMENS	1	
-	Z 051 020	eliminator		1				accessories for mobile phones	'6200/8200' MOTOROLA		
-	Z 051 019	aerial adapter		1		-	Z 051 087	mobile phone holder battery charger		1	
-	Z 051 022	leather bag	black	1		-	Z 051 088	charging cable		1	
-	Z 051 080	charging/discharging unit	only for: '2110' NOKIA	1		-	Z 051 089	leather bag	black for: 6200/FLARE	1	
		accessories	for: 'S1' SIEMENS and 'CMD100' SONY			-	Z 051 090	leather bag	black for: 8200	1	
-	Z 051 062	active fixture		1				accessories for mobile phones	'S3COM' SIEMENS		
		accessories	for: 'S3' SIEMENS and '3242' AT&T			-	Z 051 092	slim battery STANDBY-ZEIT LADEZEIT	600 MAH 26 STD. 1,5 STD.	1	
-	Z 051 064	vehicle installation kit		1		-	Z 051 092	slim battery STANDBY-ZEIT LADEZEIT	600 MAH 26 STD. 1,5 STD.	1	
-	Z 051 063	active fixture		1		-	Z 051 093	power pack STANDBY-ZEIT LADEZEIT	1100 MAH 42 STD. 2,5 STD.	1	
-	Z 051 057	charging cable		1							
-	Z 051 061	slim battery		1							

Model	Year	MG	SG	Illustration	VIN No.	Update	15:23	18.02.20100		ETKA	
ZPA	90	0	01	1-14		336					



Pos	Part Number	Name	Remarks	Qty	Model	Pos	Part Number	Name	Remarks	Qty	Model
-	Z 051 094	leather bag	black	1							
		accessories for mobile phones	'S4' SIEMENS								
-	Z 051 091	charging cable		1							
		accessories	UNIVERSAL								
-	Z 051 013	sim adapter card	'SIM'	1							
-	Z 051 073	replacement microphone	black	1							
-	Z 051 074	replacement loudspeaker	black	1							
-	Z 051 963	booster D-NETZ COMPENSER	'MCT 900 2K'	1							
-	Z 051 964	booster E-NETZ-COMPENSER	'MCT 1800'	1							
-	Z 051 084	sensor VIBRATIONSALARM GSM (KUGELSCHREIBER)	silver	1							
-	Z 051 105	mobile phone holder	'ARAT' black for: LUEFTUNG	1	PASSAT						

Model	Year	MG	SG	Illustration	VIN No.	Update	15:24	18.02.20100		ETKA	
ZPA	90	0	01	1-15		336					

Pos	Part Number	Name	Remarks	Qty	Model
-	3A0 035 505	two-way aeral (phone/radio) roof combination aerial only for: taxi equipment		1	PASSAT 94>
-	3A0 035 505 A	roof combination aerial only for: police vehicles		1	PASSAT 94>
-	3A0 051 849 B	rod-type aerial only for:	3A0 035 505 A	1	
	3B0 035 505 A	combinat. aerial (radio/phone) roof combination aerial as required use:	genuine vw 3B0 051 849	1	PASSAT 97> PASSAT VARIANT 98>
	3B0 051 505	roof combination aerial for simultaneous mobile phone and radio operation frequency crossover rod-type aerial aerial wire mounting instructions also use: adapter	genuine vw gsm/ d-network integrated 3B0 051 849 3B9 051 723 1H0 051 551 A	1	PASSAT 94>96 PASSAT VAR. 94>97 PASSAT 97> PASSAT VARIANT 98> sedan 94>96 squareback 94>97
	3B0 051 849	rod-type aerial use for: combinat. aerial (radio/phone)	genuine vw 3B0 051 505 3B0 035 505 A	1	PASSAT 97> PASSAT VARIANT 98>
	3B0 035 507	roof combination aerial for simultaneous operation of radio, mobile phone, navigation frequencies: frequency diplexer: rod-type aerial	genuine vw AM/FM gsm/ d-network GPS integrated 3B0 051 849 A	1	PASSAT 97> PASSAT VARIANT 98>



Model	Year	MG	SG	Illustration	VIN No.	Update	15:24	18.02.20100		ETKA	
ZPA	90	0	01	1-15		336					

Pos	Part Number	Name	Remarks	Qty	Model	Pos	Part Number	Name	Remarks	Qty	Model
	1J0 035 507	roof combination aerial for simultaneous operation of radio,mobile phone,navigation for vehicles with navigations-system ans integratet autoradio	replacement pt	1	PASSAT LIM. 98> VAR. 98>	-	Z 051 308	cellnet carphone aerial window clamp aerial comprising: KABEL 230 CM,MONTAGEMATERIAL	c network	1	
		as required use:	3B0 051 849 A					only for: PHILIPS			
	3B0 051 849 A	rod-type aerial use for: roof combination aerial for simultaneous operation of radio,mobile phone,navigation frequencies:	genuine vw	1		-	Z 051 319	adapter	'BNC'	1	
			3B0 035 507			-	Z 051 354	antenna MIT COBALT-MAGNETFUSS aerial reflector connection cable MINICRIMP-ANSCHLUSS	'MINIMAG' C-NETZ 15 CM 5 M	1	
	000 051 506 B	mobile phone aerial for installation in bumper	gsm/ d-network amps rear	1	PASSAT 94>96	-	Z 051 885	antenna	'KATHREIN' C-NETZ	1	
		with: aerial wire aerial > transmitter/receiver	1400MM					also use: Z 051 320 Z 051 319 Z 051 321			
	000 051 506 C	roof combination aerial for simultaneous mobile phone and radio operation frequency crossover rod-type aerial aerial wire mounting instructions	votex gsm/ d-network integrated	1	PASSAT 94>96 squareback 94>96	-	Z 051 326	antenna	'KATHREIN' C-NETZ 18CM	1	
		also use:	1H0 035 551 A					also use: Z 051 320 Z 051 319 Z 051 321			
	000 051 506 C	roof combination aerial for simultaneous mobile phone and radio operation frequency crossover rod-type aerial aerial wire mounting instructions	votex gsm/ d-network integrated	1	PASSAT 97> squareback 98>	-	Z 051 327	replacement radiator	only for: Z 051 326	1	
			000 051 849 D			-	Z 051 327	replacement radiator	only for: Z 051 326	1	
	000 051 849 D	rod-type aerial use for: combinat. aerial (radio/phone)	votex	1		-	Z 051 328	antenna comprising: aerial reflector connection cable	'KATHREIN' C-NETZ 54CM 300 CM	1	
			000 051 506 C					KOMPLETT MIT BEFESTIGUNGS-MATERIAL UND MONTAGEMATERIAL			
	1H0 035 551 A	adapter for installing combinat. aerial (radio/phone)	genuine vw	1	PASSAT 94>96 PASSAT squareback 94>97			comprising: Z 051 329			
			gsm/ d-network 3B0 035 505 A 3B0 051 505 000 051 506 C					also use: Z 051 320 N Z 051 319 BNC			



Model	Year	MG	SG	Illustration	VIN No.	Update	15:24	18.02.20100		ETKA	
ZPA	90	0	01	1-15		336					

Pos	Part Number	Name	Remarks	Qty	Model	Pos	Part Number	Name	Remarks	Qty	Model
-	Z 051 329	replacement radiator	Z 051 321 TNC	1		-	Z 051 085	roof combination aerial aerial reflector connection cable comprising:	C/D-NETZ 450 MM 0,2 M Z 051 935 Z 051 916	1	
		only for:	Z 051 328					also use:			
-	Z 051 347	mobile phone aerial SCHEIBENANTENNE aerial reflector connection cable comprising:	'KATHREIN' C-NETZ 230MM 5 M Z 051 348 Z 051 349	1		-	Z 051 935	aerial telescope	only for: Z 051 085	1	
-	Z 051 349	fitting kit	only for: Z 051 347 Z 051 352	1		-	Z 051 299	adapter		1	
-	Z 051 348	replacement radiator	only for: Z 051 347	1		-	Z 051 872	aerial filter	'EUROLINE' KATHREIN	1	
-	Z 051 352	mobile phone aerial SCHEIBENANTENNE aerial reflector connection cable comprising:	'KATHREIN' C-NETZ 640MM 5 M Z 051 353 Z 051 349 Z 051 330	1		-	Z 051 876	replacement radiator	only for: Z 051 875	1	
		MIT WEICHE ALS KOMBIANTENNE				-	Z 051 895	antenna MAGNETFUSSANTENNE aerial reflector connection cable MINICRIMP-ANSCHLUSS	'MINI' D-NETZ 7 CM 2,3 M	1	
-	Z 051 353	replacement radiator	only for: Z 051 352	1		-	Z 051 901	antenna MAGNETFUSSANTENNE comprising: connection cable MINICRIMP-ANSCHLUSSSTECKER	ROADLINE 'RT 245 M' D-NETZ 2,5 M	1	
-	Z 051 875	antenna	EUROLINE 2 'KATHREIN'	1		-	Z 051 903	antenna FENSTERKLEMMANTENNE comprising: connection cable MINICRIMP-ANSCHLUSSSTECKER	ROADLINE 'RT 220' D-NETZ 2 M	1	
		MIT WEICHE Z 051 872 GLEICHZ.	C/D-NETZ				6K0 051 507 A	antenna window clamp aerial but not: for vehicles with laminated insulated glass	gsm/ d-network votex	1	
		aerial reflector	180 MM								
		connection cable	3380 MM								
		MINICRIP-ANSCHLUSS									
		comprising:	Z 051 876			-	Z 051 894	antenna window clamp aerial comprising: connection cable MINICRIMP-ANSCHLUSS	D-NETZ KATHREIN 2,0 M	1	
		also use:	Z 051 320 N								
			Z 051 319 BNC								
			Z 051 321 TNC			-	Z 051 932	aerial reflector	D-NETZ KATHREIN 50 CM rear fitting Z 051 937 Z 051 933	1	PASSAT
			Z 051 299					GLEICHZEITIGER TELEFON UND RADIOBETRIEB MIT ANTENNENWEIC. also use:			



Pos	Part Number	Name	Remarks	Qty	Model	Pos	Part Number	Name	Remarks	Qty	Model
-	Z 051 933	aerial base	rear fitting	1	PASSAT			for fender	KATHREIN		
		only for:	Z 051 932						rear fitting		
-	Z 051 893	mobile phone aerial		1				aerial reflector	837 MM		
		MAGNETHAFTANTENNE	'KATHREIN'					connection cable	1470 MM		
-	Z 051 898	replacement radiator		1				MINICRIP-ANSCHLUSS			
		only for:	Z 051 893					comprising:	Z 051 884		
-	Z 051 877	antenna	D-NETZ	1				also use:	Z 051 320 N		
			'EUROLINE'						Z 051 319 BNC		
			KATHREIN						Z 051 321 TNC		
		aerial reflector	100MM						Z 051 299		
		connection cable	3380MM								
		MINICRIMP-ANSCHLUSS	Z 051 878								
		comprising:									
-	Z 051 878	replacement radiator		1				replacement radiator		1	
		only for:	Z 051 877					only for:	Z 051 883		
-	Z 051 878	replacement radiator		1				antenna	D-NETZ	1	
		only for:	Z 051 877						ROADLINE		
									'RT 100 M'		
-	Z 051 873	antenna	D-NETZ	1				ANTENNENFUSS MIT MINICRIMP-	100 MM		
			'EUROLINE'					ANSCHLUSSBUCHSE	Z 051 906		
			KATHREIN					aerial reflector			
		aerial reflector	310MM					comprising:			
		connection cable	3380MM								
		MINICRIMP-ANSCHLUSS	Z 051 874								
		comprising:									
		also use:	Z 051 320								
			Z 051 319								
			Z 051 321								
			Z 051 299								
			Z 051 330								
-	Z 051 299	adapter		1				antenna	gsm/ d-network	1	
									ROADLINE		
									'RT 100 K'		
-	Z 051 330	aerial filter	'KATHREIN'	1				replacement radiator		1	
-	Z 051 874	replacement radiator		1				only for:	Z 051 905		
		only for:	Z 051 873						Z 051 909		
-	Z 051 883	mobile phone aerial	D-NETZ	1				antenna	gsm/ d-network	1	

Model	Year	MG	SG	Illustration	VIN No.	Update	15:24	18.02.20100		ETKA	
ZPA	90	0	01	1-15		336					



Pos	Part Number	Name	Remarks	Qty	Model	Pos	Part Number	Name	Remarks	Qty	Model
			ROADLINE						Z 051 334		
			'RT 335 M'						Z 051 335		
		aerial reflector	310 MM						Z 051 336		
		comprising:	Z 051 908						Z 051 337		
			'RT 335 E'						Z 051 888		
		also use:	Z 051 333			-	6K0 051 507	antenna		1	
			Z 051 334					ON-GLASS-ANTENNE			
			Z 051 335					FUER FAHRZEUGE OHNE VERBUND-DAEMMGLAS			
			Z 051 336			-	Z 051 924	antenna	D-NETZ	1	
			Z 051 337					ON-GLASS-FENSTERKLEMMANTENNE	'ALLGON ULTRA'		
			Z 051 888					aerial reflector	COLINEARER		
								connection cable	5 M RG 58		
								also use:	Z 051 925		
-	Z 051 908	replacement radiator	Z 051 907	1		-	Z 051 925	repair kit		1	
		only for:	Z 051 910			-	Z 051 926	screen aerial	D-NETZ	1	
								SCREENFIX	KATHREIN		
								and/or	Z 051 927		
									Z 051 928		
						-	Z 051 927	aerial reflector	100 MM	1	
						-	Z 051 928	aerial reflector	302 MM	1	
						-	Z 051 904	roof combination aerial	ROADLINE	1	
								FUER RADIO- UND TELEFONBETRIEB	'NRC-760'		
								MIT AKTIVER FREQUENZWEICHE	D-NETZ		
								FUER FAHRZ.MIT HF-KABEL U.M-10			
								GEWINDEANSCHLUSS HF-ADAPTER	000 051 550 A		
								MITBESTELLEN			
								comprising:	Z 051 922		
						-	Z 051 922	aerial reflector	replacement pt	1	
									for		
									roof aerial		
									Z 051 904		
						-	000 051 550 A	adapter		1	
								with:			
								(screw connection)			
						-	Z 051 879	carphone, d-network/gsm		1	
								SCREENFIX-SCHEIBENANTENNE	'KATHREIN'		
								also use:	Z 051 349		
									Z 051 320		
									Z 051 319		
									Z 051 321		
									Z 051 299		
									Z 051 333		

Model	Year	MG	SG	Illustration	VIN No.	Update	15:24	18.02.20100		ETKA	
ZPA	90	0	01	1-15		336					



Pos	Part Number	Name	Remarks	Qty	Model	Pos	Part Number	Name	Remarks	Qty	Model
-	Z 051 349	fitting kit		1		-	Z 051 001	carphone, e-network MINIMAGNETANTENNE connection cable MINICRIMP-ANSCHLUSS	'ROADLINE' 40 MM 2,5 M	1	
-	Z 051 320	adapter	'N'	1		-	Z 051 002	carphone, e-network MINIMAGNETANTENNE connection cable MINICRIMP-ANSCHLUSS	'ROADLINE' 90 MM 2,5 M	1	
-	Z 051 319	adapter	'BNC'	1		-	Z 051 003	carphone, e-network TOPFMAGNETANTENNE connection cable MINICRIMP-ANSCHLUSS	'ROADLINE' 55 MM 2,5 M	1	
-	Z 051 321	adapter	'TNC'	1		-	Z 051 004	carphone, e-network MAGNET-HAFTANTENNE	'KATHREIN'	1	
-	Z 051 299	adapter		1		-	Z 051 005	replacement radiator	only for: Z 051 0004	1	
-	Z 051 880	replacement radiator	only for: Z 051 879	1		-	Z 051 012	carphone, e-network antenna aerial reflector MINICRIMP-ANSCHLUSS	KATHREIN 53 MM	1	
-	Z 051 914	roof combination aerial comprising: BEI VORHANDENEN KABEL	D/E-NETZ Z 051 923 also use: Z 051 916 Z 051 534	1	VW AUDI						
-	Z 051 914	roof combination aerial comprising: BEI VORHANDENEN KABEL	D/E-NETZ Z 051 923 also use: Z 051 916 Z 051 534	1	VW AUDI						
-	Z 051 923	aerial reflector	replacement pt only for: Z 051 914	1							
-	Z 051 916	aerial adapter		1							
-	Z 051 008	carphone, e-network FENSTERKLEMMANTENNE	'KATHREIN CLASSIC'	1							
-	Z 051 007	carphone, e-network FENSTERKLEMMANTENNE connection cable MINICRIMP-ANSCHLUSS	'ROADLINE' 550 MM	1							
-	Z 051 010	carphone, e-network antenna aerial reflector MINICRIMP-ANSCHLUSS	'ROADLINE' 55 MM also use: Z 051 011	1							
-	Z 051 011	carphone, e-network ERGAENZUNGSSTRAHLER	'ROADLINE' 90 MM only for: Z 051 010 ZUR AUFRUESTUNG VON 0-DB AUF 3-DB	1							
-	Z 051 006	carphone, e-network screen aerial antenna MINISCRIMP-ANSCHLUSSBUCHSE MINISCRIMP-KABEL	'ROADLINE' black 420 MM 4 M	1							

Model	Year	MG	SG	Illustration	VIN No.	Update	15:27	18.02.20100		ETKA	
ZPA	90	0	01	1-16		336					



Pos	Part Number	Name	Remarks	Qty	Model
-	Z 051 936	accessories for mobile phone and two-way radio aerials aerial wire connections: radio AKTIVE FREQUENZWEICHE	4600MM M10X0,75 12 V-LEITER	1	
-	Z 051 820	coupling adapter FUER VERLAENGERUNGSKABEL MIT SCHRAUBANSCHLUSS	M10X0,75	1	
-	Z 051 916	aerial adapter ZWISCHEN DACHKOMBIANTENNE UND SERIEN-ANTENNENLEITUNG		1	VW
-	Z 051 919	aerial wire SCHRAUBBAR ZUR VERBINDUNG VON WEICHE MIT radio FUER RADIOS MIT WINKELSTECKER Z 051 859 ERFORDERLICH	1500MM	1	
	3A0 035 550 A	aerial wire diplexer>transmitter/receiver use for: combinat. aerial (radio/phone) combinat. aerial (radio/phone) taxi equipment	5150MM genuine vw LH0 051 508 A 8D5 051 501	1	PASSAT 94>
-	6K0 051 585	aerial filter for simultaneous mobile phone and radio operation connections: radio telephone antenna use for: combinat. aerial (radio/phone) combinat. aerial (radio/phone)	c/d network passive votex M10X0,75 MINICRIMP MINICRIMP 8D5 051 501 LH0 051 508 A	1	
-	Z 051 332	coupling adapter FUER C-NETZ AUTOTELEFONKABEL GEMAESS MINICRIMPSYSTEM ZUM VERLAENGERN VON BEREITS VERLEGTEN C-NETZ -KABELN	'AS-N/N'	1	

Model	Year	MG	SG	Illustration	VIN No.	Update	15:27	18.02.20100		ETKA	
ZPA	90	0	01	1-16		336					



Pos	Part Number	Name	Remarks	Qty	Model	Pos	Part Number	Name	Remarks	Qty	Model
-	Z 051 338	adapter ZUM ANSCHLUSS VON M11 AN MINICRIMP. only for:	51CM	1		-	Z 051 336	connection cable MINICRIMP	3380MM	1	
-	Z 051 937	aerial filter for simultaneous mobile phone and radio operation connections: radio telephone antenna	13,4X60X41MM KATHREIN C,-D,U.E-NETZ M10X0,75 (M) M8X0,75 (M) M8X0,75	1		-	Z 051 337	connection cable MINICRIMP	4280MM	1	
	000 051 550 A	adapter for conversion of: antenna combinat. aerial (radio/phone) with: (screw connection) frequency diplexer:	>> M10,0,75 integrated	1		-	Z 051 887	rf coaxial cable roller ZUM HERSTELLEN VON ANSCHLUSS- KABELN IM AUTOTELEFONBEREICH	50 OHM 100M	1	
-	1H0 051 550	adapter adapter cable DOPPELRASTSTECKER>T.WEICHE M10	75 OHM 190CM VOTEX for: C-NETZ	1		-	Z 051 888	connection cable MINICRIMP	5000MM	1	
	3A0 035 550 C	aerial wire diplexer>transmitter/receiver connections: use for: combinat. aerial (radio/phone) combinat. aerial (radio/phone) police vehicles	300CM genuine vw SAP/SAP 8D5 051 501 1H0 051 508 A	1	PASSAT 94>	-	Z 051 872	aerial filter FUER GLEICHZEITIGEN BETRIEB IM C- UND D-NETZ AN GEMEINSAMER ANTENNE also use:	'EUROLINE' Z 051 299	1	
-	3A0 051 849 B	rod-type aerial police vehicles only for:	3A0 035 505 A	1	PASSAT 94>	-	Z 051 299	adapter MINI-UHF AUF MINICRIMP FUER C-NETZ UND carphone, d-network/gsm	for: Z 051 872	1	
-	3A0 035 585 A	aerial filter police vehicles only for:	PASSAT 94>	1	PASSAT 94>	-	Z 051 356	carphone angled adapter VON TNC AUF MINICRIMP	AS-TNC/WS	1	
-	Z 051 331	connection cable VON GEWINDE M10 AUF SCHRAUB- ANSCHLUSS M10	3000MM C-NETZ	1		-	Z 051 357	carphone angled adapter VON BNC AUF MINICRIMP	AN-BNC/WS	1	
-	Z 051 333	connection cable MINICRIMP	510MM	1		-	Z 051 355	minicrimp connector FUER KOAXIALKABEL RG 58 Z 051 887 IN VERBINDUNG MIT MINICRIMPZANGE Z 051 358		1	
-	Z 051 334	connection cable MINICRIMP	1470MM	1		-	Z 051 358	minicrimp pliers	MZ 58	1	
-	Z 051 335	connection cable MINICRIMP	2420MM	1		-	Z 051 911	adapter AUF MINICRIMP ZUM ANSCHLUSS VON AUTO-TELEFONEN	SMA-MF	1	
						-	Z 051 912	cable angled connector MIT SCHELLE HF-STECKVERBINDUNG MIT GEWINDE M11X1 FUER RG 58 ZUM ANSCHLUSS AN AUTO-FUNKANTENNEN MIT SPEZIALFUSS		1	

Model	Year	MG	SG	Illustration	VIN No.	Update	15:28	18.02.20100		ETKA	
ZPA	90	0	01	1-17		336					



Pos	Part Number	Name	Remarks	Qty	Model
-	059 035 271	interference suppression suppression condenser for alternator:	clip '+' AUS DEN SAETZEN:	1	
			000 035 660 B 431 035 660 C 431 035 660 B 000 035 660 A 281 035 660 A 173 035 660 A 211 035 660 C 211 035 660 D 281 035 660 873 035 660 823 035 657 C 000 035 657 251 035 660		
-	803 035 295	supression choke FUER KLEINMOTOREN		1	
-	Z 051 917	interference suppression coil FUER AUTORADIOS BIS 50 WATT IN VERBINDUNG MIT HIGH-POWER- GERAETEN FUER: EINSCHALTSTROMLEITUNG MEMORYLEITUNG LICHTLEITUNG		1	
-	Z 051 918	interference suppression coil FUER AUTORADIOS UND VERSTAERK. BIS 200 WATT IN VERBINDUNG MIT HIGH-POWER- GERAETEN FUER: EINSCHALTSTROMLEITUNG	200 W	1	

Model	Year	MG	SG	Illustration	VIN No.	Update	15:28	18.02.20100		ETKA	
ZPA	90	0	01	1-18		336					



Pos	Part Number	Name	Remarks	Qty	Model
-	3A0 061 120	centre console centre console (for service installation)	'BIKER'	1	PA 88>
	4/88 01C	satin black part corresponds to:	3A0 863 319	1	PA 88>

Model	Year	MG	SG	Illustration	VIN No.	Update	15:29	18.02.20100		ETKA	
ZPA	90	0	01	1-19		336					



Pos	Part Number	Name	Remarks	Qty	Model
-	357 061 131 A	cassette holders, cassettes cassette holder with drawer filled display only in combination with: standard tunnel oddments tray	4 cassettes AN HANDBREMSE	1	PASSAT 88> PASSAT 94> notchback
	8/74 01C	satin black			
-	357 061 130 A	cassette holder with drawer filled display only in combination with: standard tunnel oddments tray	6 cassettes centre console	1	PASSAT 88> PASSAT 94> notchback
	8/74 01C	satin black			
	8D1 061 130	cassette holder with drawer filled display only in combination with: standard console	4 cassettes	1	PASSAT 97> VARIANT 98>
	10/96 01C	satin black			
-	Z 051 389	cassette holder centre console MIT BELEGUNGSANZEIGE	6 cassettes black	1	PASSAT 88>96 PASSAT VARIANT 88>
-	Z 051 397	cassette holder FUER ABLAGEFACH ZWISCHEN DEN FRONTSITZEN MIT BELEGUNGSANZEIGE	6 cassettes black	1	PASSAT 97>
-	Z 051 390	cassette holder UNIVERSELL VERWENDBAR	6 cassettes LAENGER	1	
-	Z 051 391	cassette holder UNIVERSELL VERWENDBAR	6 cassettes diagonal	1	
-	357 061 133 A	cd-archive with drawer filled display only in combination with: standard tunnel oddments tray	for 6 cd's	1	PASSAT 88> PASSAT 94> notchback
	8/74 01C	satin black			
-	Z 051 434	cd-magazine centre console MIT ZUSAETZLICHEM ABLAGEFACH MIT BELEGUNGSANZEIGE	for 6 cd's black	1	PASSAT notchback 88>96 PASSAT VARIANT 88>

Model	Year	MG	SG	Illustration	VIN No.	Update	15:29	18.02.20100		ETKA	
ZPA	90	0	01	1-19		336					



Pos	Part Number	Name	Remarks	Qty	Model	Pos	Part Number	Name	Remarks	Qty	Model
-	Z 051 398	cd-magazine FUER ABLAGEFACH ZWISCHEN DEN FRONTSITZEN MIT ZUSAETZLICHEN ABLAGEFACH MIT BELEGUNGSANZEIGE	for 6 cd's black	1	PASSAT 97>						
-	Z 051 392	cd-magazine UNIVERSELL VERWENDBAR	for 6 cd's	1							
-	000 051 685 A	lighting cable cassette holder for vehicles with radio and for vehicles prepared for radio		1	>88						

Model	Year	MG	SG	Illustration	VIN No.	Update	15:29	18.02.20100		ETKA	
ZPA	90	0	05	5-01		336					



Pos	Part Number	Name	Remarks	Qty	Model
		battery	VARTA		
	431 056 105 PH	battery	not filled volt/ah: 12V/36AH type: 536 46 kaeltepruefstrom: 175A VARTA not for:	1	PASSAT 86> otto engine 6 cylinder
	431 056 205 PH	battery	filled volt/ah: 12V/36AH type: 536 46 kaeltepruefstrom: 175A VARTA not for:	1	PASSAT 86> otto engine 6 cylinder
	431 056 210 PH	battery	filled volt/ah: 12V/36AH type: 536 46 kaeltepruefstrom: 175A blue dynamic VARTA not for:	1	PASSAT 86> otto engine 6 cylinder
	1H0 056 105 A	battery	not filled volt/ah: 12V/44AH kaeltepruefstrom: 220A type: 544 69 VARTA not for:	1	PASSAT 86> otto engine 6 cylinder
	1H0 056 205 A	battery	filled volt/ah: 12V/44AH type: 544 69 kaeltepruefstrom: 220A white VARTA not for:	1	PASSAT 86> otto engine 6 cylinder
	1H0 056 105 BA	battery	BLUE DYNAMIC volt/ah: 12V/44AH kaeltepruefstrom: 220A type: 544 69 VARTA only for:	1	PASSAT otto engine
	1H0 056 105 BA	battery	BLUE DYNAMIC volt/ah: 12V/44AH kaeltepruefstrom: 220A type: 544 69 VARTA only for:	1	PASSAT otto engine

Model	Year	MG	SG	Illustration	VIN No.	Update	15:29	18.02.20100		ETKA	
ZPA	90	0	05	5-01		336					



Pos	Part Number	Name	Remarks	Qty	Model	Pos	Part Number	Name	Remarks	Qty	Model
	000 056 030 HF	battery	not filled volt/ah: 12V/45AH type: 545 19 kaeltepruefstrom: 220A VARTA not for:	1	PASSAT 86> otto engine 6 cylinder		1H0 056 105	battery	not filled volt/ah: 12V/60AH type: 560 73 kaeltepruefstrom: 280A white VARTA only for:	1	PASSAT 92> otto engine 6 cylinder
	8/85 043	code key					1H0 056 105 BB	battery	BLUE DYNAMIC volt/ah: 12V/60AH type: 560 73 kaeltepruefstrom: 280A VARTA only for:	1	otto engine
	000 056 230 HF	battery	filled volt/ah: 12V/45AH type: 545 19 kaeltepruefstrom: 220A VARTA not for:	1	PASSAT 86> otto engine 6 cylinder		811 056 105 DH	battery	not filled volt/ah: 12V/64AH type: 564 20 kaeltepruefstrom: 380A VARTA	1	PASSAT 85> diesel eng. 1.6ltr. PASSAT 89> diesel eng. 1.9ltr.
	8/85 043	code key					811 056 205 DH	battery	filled volt/ah: 12V/64AH type: 564 20 kaeltepruefstrom: 380A VARTA	1	PASSAT 85> diesel eng. 1.6ltr. PASSAT 89> diesel eng. 1.9ltr.
	000 056 210 HT	battery	filled volt/ah: 12V/45AH type: 545 19 kaeltepruefstrom: 220A blue dynamic VARTA not for:	1	PASSAT 86> otto engine 6 cylinder		811 056 210 D	battery	filled volt/ah: 12V/64AH type: 564 20 kaeltepruefstrom: 380A blue dynamic VARTA	1	PASSAT 85> diesel eng. 1.6ltr. PASSAT 89> diesel eng. 1.9ltr.
	8/85 043	code key					1H0 056 105 C	battery	not filled volt/ah: 12V/72AH kaeltepruefstrom: 380A type: 572 30 white VARTA	1	PASSAT 89> diesel eng. 1.9ltr.
	431 056 105 NH	battery with gas discharge	not filled high current type: 550 44 volt/ah: 12V/50AH kaeltepruefstrom: 265 A VARTA not for:	1	PASSAT 86> otto engine 6 cylinder		7D0 056 105 A	battery	not filled type: 592 26 volt/ah: 12/92 kaeltepruefstrom: 450 A VARTA	1	PASSAT diesel eng. 4 cylinder PASSAT 89> diesel eng. 1.9ltr.
	431 056 205 NH	battery with gas discharge	filled high current type: 550 44 volt/ah: 12V/50AH kaeltepruefstrom: 265 A VARTA not for:	1	PASSAT 86> otto engine 6 cylinder		7D0 056 205 A	battery	filled type: 592 26 volt/ah: 12/92 kaeltepruefstrom: 450 A VARTA	1	PASSAT diesel eng. 4 cylinder PASSAT 89> diesel eng. 1.9ltr.
	431 056 210 NH	battery with gas discharge	filled blue dynamic type: 550 44 volt/ah: 12V/50AH kaeltepruefstrom: 265 A VARTA not for:	1	PASSAT 86> otto engine 6 cylinder						

Model	Year	MG	SG	Illustration	VIN No.	Update	15:29	18.02.20100		ETKA	
ZPA	90	0	05	5-01		336					



Pos	Part Number	Name	Remarks	Qty	Model	Pos	Part Number	Name	Remarks	Qty	Model
	191 056 205 A	battery	filled voltage: 12V/38AH type: 880 38 kaeltepruefstrom: 215A grand prix VARTA	1	PASSAT 86> otto engine						-VARIANT -SYNCRO 92>
	191 056 205 E	battery	filled voltage: 12V/46AH type: 880 46 kaeltepruefstrom: 255A grand prix VARTA	1	PASSAT 86> otto engine						PASSAT 1.5 L (DIESEL) 85>
	191 056 205 H	battery	filled voltage: 12V/56AH type: 880 56 kaeltepruefstrom: 320A grand prix VARTA	1	PASSAT 86> otto engine	-	Z 056 105	battery	type: 545 19 voltage: 12/45 kaeltepruefstrom: 220 A SONNENSCHIEIN	1	PASSAT 74>92 (BENZIN)
	191 056 205 M	battery	filled voltage: 12V/66AH type: 880 66 kaeltepruefstrom: 355A grand prix VARTA	1	PASSAT 85> diesel eng. 1.6ltr. PASSAT 89> diesel eng. 1.9ltr.	-	Z 056 125	battery	type: 501 00 voltage: 12/48 kaeltepruefstrom: 220 A TECHNO	1	otto engine PASSAT 74>92 - CL 1.8 - CL 2.0 - GL 2.0 16V squareback/ SYNCRO PASSAT 74>85
-	Z 056 101	battery	type: 536 46 voltage: 12/36 kaeltepruefstrom: 175 A SONNENSCHIEIN	1	PASSAT 74>85 (BENZIN)	-	Z 056 070	battery	type: 502 00 voltage: 12/57 kaeltepruefstrom: 265 A SONNENSCHIEIN	1	PASSAT 86>92 (BENZIN)
-	>Z 056 052	battery	type: 563 18 voltage: 12/63 kaeltepruefstrom: 300 A TECHNO	1	PASSAT CL 1.8;-2.0; GL 2.0;-16V -VARIANT -SYNCRO (BENZIN) 92> PASSAT GL VR6;	-	Z 056 126	battery	type: 502 00 voltage: 12/57 kaeltepruefstrom: 265 A TECHNO	1	PASSAT (BENZIN) 86>92
						-	Z 056 115	battery	12V61AH/315A SONNENSCHIEIN TYP 561 11	1	4-cylinder/ diesel eng.: PASSAT
						-	Z 056 117	battery	type: 592 15 voltage: 12/95 kaeltepruefstrom: 450 A EURO EXIDE	1	PASSAT diesel eng.: 4 cylinder
						-	Z 056 122	battery	type: 592 15 voltage: 12/95 kaeltepruefstrom: 450 A TECHNO	1	PASSAT diesel eng.: 4 cylinder
						-	Z 056 104	battery		1	PASSAT 1.5 L

Model	Year	MG	SG	Illustration	VIN No.	Update	15:29	18.02.20100		ETKA	
ZPA	90	0	05	5-01		336					



Pos	Part Number	Name	Remarks	Qty	Model	Pos	Part Number	Name	Remarks	Qty	Model
		type:	654 20		(DIESEL) 85>						-SYNCR0
		volt/ah:	12/64		PASSAT TURBO						92>
		kaeltepruefstrom:	380 A		-1,6 LTR.	-	Z 056 071	battery		1	PASSAT 1.5 L (DIESEL) 85>
			SONNENSCHIEIN		85>92			type: 502 00			
					PASSAT 1,9 L			volt/ah: 12/57			
					89>92	-	Z 056 071	battery	kaeltepruefstrom: 265 A	1	PASSAT 1.5 L (DIESEL) 85>
					PASSAT			type: 502 00			
					(DIESEL) CL			volt/ah: 12/57			
					1.9TD;-TDI	-	Z 056 097	battery	kaeltepruefstrom: 265 A	1	PASSAT TAXI
					-VARIANT			SONNENSCHIEIN			
					93>	-	Z 056 127	battery	12V68AH	1	PASSAT TAXI
-	Z 056 124	battery		1	PASSAT 1,9 L 89>92			SONNENSCHIEIN	TYP 568 20	1	PASSAT CL
		type:	588 32					type: 503 00			1.8;-2.0;
		volt/ah:	12/88					volt/ah: 12/70			GL 2.0;-16V
		kaeltepruefstrom:	395 A					kaeltepruefstrom: 330 A			-VARIANT
			SONNENSCHIEIN								TECHNO
-	Z 056 113	battery		1	PASSAT CL 1.8;-2.0; GL 2.0;-16V						-SYNCR0 (BENZIN)
		type:	544 69								92>
		volt/ah:	12/44								PASSAT GL
		kaeltepruefstrom:	220 A								VR6;
			SONNENSCHIEIN								-VARIANT
-	Z 056 114	battery		1	PASSAT CL						-SYNCR0
		type:	560 73		1.8;-2.0;						92>
		volt/ah:	12/60		GL 2.0;-16V						PASSAT 1.5 L (DIESEL) 85>
		kaeltepruefstrom:	450 A		-VARIANT						PASSAT TURBO
			SONNENSCHIEIN		-SYNCR0						-1,6 LTR.
					(BENZIN)						85>92
					92>						PASSAT
					PASSAT GL						
					VR6;						
					-VARIANT						
					-SYNCR0						
					92>						
					PASSAT 1.5 L (DIESEL) 85>						
					PASSAT TURBO						
					-1,6 LTR.						
					85>92						
					PASSAT						
					-VARIANT						

Model	Year	MG	SG	Illustration	VIN No.	Update	15:29	18.02.20100		ETKA	
ZPA	90	0	05	5-01		336					



Pos	Part Number	Name	Remarks	Qty	Model	Pos	Part Number	Name	Remarks	Qty	Model
					(DIESEL) CL 1.9TD;-TDI -VARIANT 93> -VR6 -TAXI						
-	Z 056 116	battery	12V72AH/380A SONNENSCHLEIN TYP 572 30	1	4-cylinder/ diesel eng.: PASSAT TAXI						
-	Z 056 110	battery screw connection	M18 KREUZSCHLITZ	1							
-	000 056 045	electrolyte	4X 1LTR.	1							

Model	Year	MG	SG	Illustration	VIN No.	Update	15:30	18.02.20100		ETKA	
ZPA	90	0	05	5-02		336					



Pos	Part Number	Name	Remarks	Qty	Model
		spark plugs			
-	Z 057 069	spark plug	14-8DTU BERU	1	EP,PP,SA,RF,DT 86>,RN/RU/RL,
-	Z 057 017	spark plug	N9BYC CHAMPION	1	EP,PP,RL,SA,RF,DT 86>,RN/RU, JT 86>,JT/PX
-	Z 057 041	spark plug	N9BYC4 CHAMPION	1	EP,PP,RL,DT,RN/RU,
-	Z 057 056	spark plug	14-7DU BERU	1	ZA,YJ,YN,DT,DD,
-	Z 057 013	spark plug	N7YC CHAMPION	1	ZA,ZF,ZB,YJ,ZC,YN,YP,DT,DD,
-	Z 057 137	spark plug	S5 BERU	1	ZF,YP,JN,KX,
-	Z 057 062	spark plug	14-6DU BERU	1	ZB,DS,DZ,KE,
-	Z 057 138	spark plug	S7 BERU	1	DD,JS,
-	Z 057 058	spark plug	14-5DU BERU	1	ZC,XX,YS,WN,
-	Z 057 014	spark plug	N6YC CHAMPION	1	XX,YS,YZ,WN,
-	Z 057 139	spark plug	S9 BERU	1	YZ,
-	Z 057 067	spark plug	14-6DTU green BERU	1	DS 86>,DZ 86>PB,PF,
-	Z 057 142	spark plug	14-7DUO grey BERU	1	PB,PF
-	Z 057 068	spark plug	14-7DTU green BERU	1	NE,PV 86>,JN,SF/SH,PM,RP,DS,KX,JS, JT 86>,KV, KX,KZ, JT/PX, NG, PB,
-	Z 057 019	spark plug	N7BYC CHAMPION green	1	NE,DZ 86>,PV 86>,PM, JN 86>,DS, SF/SH,JS,KV, KX,KZ,NG, PB,PF,
-	Z 057 172	spark plug	14G-8DTU BERU	1	NG(2,3LTR.),

Model	Year	MG	SG	Illustration	VIN No.	Update	15:30	18.02.20100		ETKA	
ZPA	90	0	05	5-02		336					

Pos	Part Number	Name	Remarks	Qty	Model	Pos	Part Number	Name	Remarks	Qty	Model
-	Z 057 075	spark plug	N7YCK CHAMPION grey	1	RP 88>, PB,PF,						
-	Z 057 141	spark plug	14-6DUO BERU grey	1	PB,						
-	Z 057 166	spark plug	N9BMC CHAMPION	1	PF						
-	Z 057 038	spark plug	N8GY/N9YC CHAMPION	1	JN,						
-	Z 057 018	spark plug	N6BYC CHAMPION green	1	PU,						
-	Z 057 170	spark plug	N7BMC CHAMPION	1	2E						
-	Z 057 173	spark plug	14F-6DSR BERU	1	6 A 90>,						
-	Z 057 167	spark plug	C9MCC CHAMPION	1	AAA,						
-	Z 057 200	environment retrofit kit		1	VW 4-cylinder/ diesel eng., TURBODIESEL						



Model	Year	MG	SG	Illustration	VIN No.	Update	15:30	18.02.20100		ETKA	
ZPA	90	0	05	5-05		336					

Pos	Part Number	Name	Remarks	Qty	Model
		headlights, lights			
-	Z 052 638	fog light set comprising:	'GLORYLUX' Z 052 518	1	
-	Z 052 518	fog light set		1	
-	Z 053 097	fog light set comprising:	complete	1	
		single headlight	Z 053 098	2	
		bulb		2	
		mounting instructions		1	
		housing colour:	black (plastic)		
-	Z 053 098	fog light set single headlight		1	
-	Z 052 639	fog light set complete with fitting instruc- tions and fitting material comprising:	white	1	
		halogen fog lamp	120X87X65 CM	2	
		bulb		2	
-	Z 053 090	fog light set	black	1	
-	Z 053 071	fog light set	black	1	
-	Z 052 773	turn signal lights black	front	2	PASSAT 94>
		but not: for vehicles with fog lamps			
-	Z 052 786	turn signal lights white	front	2	PASSAT 97> PASSAT squareback 97>
	3B0 052 210	turn signal not in combination with: gas discharge bulb	front white genuine vw 1 set = 2 parts install time: 10MIN	2	PASSAT 97> VARIANT 98>
-	Z 052 775	turn signal lights black	side	2	PASSAT 94>96
	3B0 052 215	turn signal	genuine vw side 1 set = 2 parts install time: 5MIN	2	PASSAT 97> PASSAT VARIANT 98>



Model	Year	MG	SG	Illustration	VIN No.	Update	15:30	18.02.20100		ETKA	
ZPA	90	0	05	5-05		336					

Pos	Part Number	Name	Remarks	Qty	Model	Pos	Part Number	Name	Remarks	Qty	Model
	8/74 041	black				-	Z 053 338	rear fog light set comprising:		1	
	8/74 060	white						rear fog light bulb	128X84MM 21 WATT 4,5M		
	Z 052 785	turn signal lights black	side	2	PASSAT 97> PASSAT squareback 98>			KABEL			
-	Z 052 787	turn signal lights white	side	2	PASSAT 94>96	-	Z 053 339	rear fog light OHNE ANBAUMATERIAL FUER ALLE TYPEN		1	
	000 052 300	braking pre-warning system	B.V.S. genuine vw 30MIN	1	PASSAT 94>96 squareback 94>97	-	Z 052 300	additional brake light KB-PRUEFNUMMER K-S3-31 486	for:	1	LIMOUSINEN KOMBI fastback
		install time: not in combination with: automatic transmission				-	Z 053 104	rotating warning light orange halogen bulb ZUR ABSICHERUNG BEI FAHRZEUG-PANNEN for vehicles with cigarette lighter	SIRIUS 210X130MM H1/12V	1	
-	Z 052 301	additional brake light gas discharge bulb red	'NEON' 9-16 V,14 W width: 425 MM approval: ECE, SAE	1		-	3A9 052 215	turn signal	side 1 set = 2 parts	1	PASSAT 94> PASSAT VARIANT 94>
-	Z 052 308	additional brake light 3-KAMMER-REFLEKTORSYSTEM comprising: 1 set of bulbs connection cable securing parts	'COMFORT' ABS (plastic)	1			8/74 041	black			
-	Z 052 309	additional brake light 7-KAMMER-REFLEKTORSYSTEM comprising: 1 set of bulbs connection cable securing parts	'ELEGANCE' ABS (plastic)	1							
-	Z 052 310	additional brake light LED-TECHNIK MIT 25 DIODEN red	'LED HIGH POWER'	1							
		with: connection cable securing parts									
-	Z 052 311	additional brake light LED-TECHNIK MIT 25 DIODEN smoke grey	'LED HIGH POWER'	1							
		with: connection cable securing parts									



Pos	Part Number	Name	Remarks	Qty	Model
		bulb			
-	Z 045 152	1 set of bulbs comprising:	'H1'	1	
			Z 046 039	1	
			Z 046 027	1	
			Z 046 032	1	
			Z 046 011	1	
			Z 046 009	1	
			Z 046 020	1	
-	Z 045 153	1 set of bulbs comprising:	'H7'	1	
			Z 046 056	1	
			Z 046 027	1	
			Z 046 032	1	
			Z 046 011	1	
			Z 046 009	1	
			Z 046 020	1	
-	Z 045 130	1 set of bulbs comprising:	'12 ASY'	1	
		ABBLENDLAMPE, ASYMMETRISCH			
		BREMS-/SCHLUSSLAMPE			
		BLINK-/BREMSLAMPE			
		bulb side light			
		SOFFITTE			
		KUGELLAMPE	10W		
		GLASSOCKELLAMPE			
		SICHERUNGEN (KERAMIK)		2	
-	Z 045 151	1 set of bulbs comprising:	12V H4	1	
		MIT KERAMIK- UND FLACH-			
		SICHERUNGEN			
		halogen bulb	'H4' 12V60/55W	1	
		BLINK-/BREMSLICHTLAMPE	12V21W	1	
		BREMS-/SCHLUSSLICHTLAMPE	12V21/5W	1	
		KUGELLAMPE	12V10W	1	
		KUGELLAMPE	12V5W	1	

Model	Year	MG	SG	Illustration	VIN No.	Update	15:31	18.02.20100		ETKA	
ZPA	90	0	05	5-06		336					



Pos	Part Number	Name	Remarks	Qty	Model	Pos	Part Number	Name	Remarks	Qty	Model
		bulb side light		1		-	Z 046 059	halogen bulb for fog lamp and for high beam	'H3 ALLWEATHER'	1	
		SOFFITTE	12V10W	1							
		KERAMIKSICHERUNG	8A	1				with holder:	PK 22 S 12 V, 55 W		
		KERAMIKSICHERUNG	16A	1							
		FLACHSICHERUNG	10A	1		-	Z 046 042	halogen bulb ASYMMETRISCHES ABBLENDLICHT	'H4' '2-FADEN-LAMPE P43T	1	
		FLACHSICHERUNG	15A	1				with holder:	12V60/55W SB-VERPACKUNG		
		FLACHSICHERUNG	20A	1							
		FLACHSICHERUNG	30A	1							
		bulb for turn signal and brake lights	'P25-1'6V21W	10		-	Z 046 061	halogen bulb 'H4 PREMIUM'	12 V,60/55 W	1	
		halogen bulb	'H3 YC'12V55W	10				with holder:	P 43 T		
		halogen bulb	'H4'12V60/55W	10				approval:	ECE-R37		
		FERN- UND ABBLENDLICHTLAMPE	12V45/40W	10							
		FERN- UND ABBLENDLICHTLAMPE	6V45/40W	10		-	Z 046 060	halogen bulb 'H4 PREMIUM'	VERKAUFDISPLAY 12 V,60/55 W	12	
		bulb for turn signal and brake lights	6V21W					with holder:	P 43 T		
		halogen bulb	'H3 YC'12V55W					approval:	ECE-R37		
		halogen bulb	'H4'12V60/55W			-	Z 046 054	halogen bulb	'H4 ALLWEATHER'	1	
		FERN- UND ABBLENDLICHTLAMPE	12V45/40W					with holder:	P43T 12V60/55W		
		FERN- UND ABBLENDLICHTLAMPE	6V45/40W								
-	Z 046 039	halogen bulb	'H1 YA'	1				with holder:	P 14,5 S		
		FUR HAUPT-UND additional driving light	12V55W			Z	046 003	headlight dipped beam bulb	assy 'P45T' 12V45/40W	1	
								with holder:			
-	Z 046 063	halogen bulb 'H1 PREMIUM'	12 V, 55 W	1							
		with holder:	P 14,5 S			-	Z 046 007	searchlight bulb e	with holder:	BA15S 12V25W	1
		approval:	ECE-R37								
-	Z 046 064	halogen bulb 'H1 PREMIUM'	VERKAUFDISPLAY 12 V, 55 W	18							
		with holder:	P 14,5 S			-	Z 046 062	bulb yellow for vehicles with side turn signals	'WY5W' 12 V, 5 W	1	PASSAT 97>
		approval:	ECE-R37					with holder:	W2,1X9,5D interior		
-	Z 046 058	halogen bulb	'H1' ALLWEATHER	1				also for:			
		with holder:	P 14,5 S 12V55W			-	Z 046 008	bulb bulb side light	'HL'	1	
								with holder:	BA9S 6V4W		
-	Z 046 051	halogen bulb FUER HAUPT- UND additional driving light	'H2'	1							
		only for:	12V55W Z 052 530			-	Z 046 009	bulb bulb side light	'HL'	1	
								with holder:	BA9S 12V4W		
-	Z 046 041	halogen bulb	'H3 YC'	1							
		with holder:	PK 22 S 12V55W								

Model	Year	MG	SG	Illustration	VIN No.	Update	15:31	18.02.20100		ETKA	
ZPA	90	0	05	5-06		336					



Pos	Part Number	Name	Remarks	Qty	Model	Pos	Part Number	Name	Remarks	Qty	Model
-	Z 046 014	bulb for dashboard lighting with holder:	'H' BA9S 6V2W	1		-	Z 046 053	bulb FUER BLINKLEUCHTEN with holder:	'PY21W' yellow 'BAU15S' 12V21W	1	
-	Z 046 015	bulb for dashboard lighting with holder:	'H' BA9S 12V2W	1		-	Z 046 037	bulb FUER INSTRUMENTEN- UND ANZEIGENBELEUCHTUNG with holder:	'W 10/3' 12V3W W2,1X9,5D	1	
-	Z 046 012	bulb for tail light with holder:	'G' BA15S 6V10W	1		-	Z 046 036	bulb FUER INSTRUMENTEN- UND ANZEIGENBELEUCHTUNG with holder:	'W 5/1,2' 12V1,2W W2X4,6D	1	
-	Z 046 013	bulb for tail light with holder:	'G' BA15S 12V10W	1		-	Z 046 036	bulb FUER INSTRUMENTEN- UND ANZEIGENBELEUCHTUNG with holder:	'W 5/1,2' 12V1,2W W2X4,6D	1	
		contents of package:		10							
-	Z 046 010	bulb for tail light with holder:	'G' BA15S 6V5W	1		-	Z 046 032	bulb FUER BREMS-/SCHLUSSLEUCHTEN MIT ZWEI LEUCHTKOERPERN with holder:	'P 25/2S' 12V21/5W BAY15D	1	
-	Z 046 011	bulb for tail light with holder:	'G' BA15S 12V5W	1		Z 046 020	bulb for interior lighting with holder: festoon bulb:	'K' 'S8' 41MM 12V10W	1		
-	Z 046 052	bulb for rear fog light with holder: festoon bulb:	'K' 12 V, 18 W S 8,5 41 MM 1 set = 2 parts	1		Z 046 021	bulb for interior lighting with holder: festoon bulb:	'L' 'S8' 36MM 6V5W	1		
-	Z 046 017	bulb for dashboard lighting with holder:	'J' BA7S 6V1,2W	1		Z 046 022	bulb for interior lighting with holder: festoon bulb:	'L' 'S8' 36MM 12V5W	1		
-	Z 046 018	bulb for dashboard lighting with holder:	'J' BA7S 12V2W	1		Z 046 023	bulb for storage compartment light with holder: festoon bulb:	'M' 'S 7-8' 28MM 12V3W	1		
	Z 046 027	bulb bulb for turn signal and brake lights with holder:	'P25/1' BA15S 12V21W	1							
		contents of package:		10							

Model	Year	MG	SG	Illustration	VIN No.	Update	15:32	18.02.20100		ETKA	
ZPA	90	0	05	5-07		336					



Pos	Part Number	Name	Remarks	Qty	Model
		instruments, fixtures			
-	Z 054 093	exterior thermometer MIT FROSTWARNER area: -25/+40 C STROMAUFNAHME: 8 MA 12 V	install.: 52mm diameter	1	
-	Z 054 073	exterior thermometer area: -35/+58 C STROMAUFNAHME: 100 MA 12 V	'LCD'	1	
-	Z 054 074	exterior/interior thermometer area: -38/+58 C STROMAUFNAHME: 130 MA 12 V	UMSCHALTBAR	1	
-	Z 054 104	thermo- meter 'CHECK TEMP II' LCD-ANZEIGE UMSCHALTBAR: area: -40/+90 C STROMAUFNAHME: 30 MA 12 V FAHRZEUGSPEZIFISCHER EINBAU BEI PASSAT 94>, WENN BLIND- DECKEL IN DER SCHALTERREIHE UNTER RADIOSCHACHT VORHANDEN	ROT/GRUEN	1	
-	Z 054 094	revolution counter MESSBEREICH: 6000 UPM	install.: 52mm diameter	1	
-	Z 054 095	revolution counter MESSBEREICH: 8000 UPM	install.: 52mm diameter	1	
-	Z 054 024	sensor oil pressure gauge sender OHNE WARNKONTAKT for dynamic oil pressure warning device also use: Z 045 031		1	
-	Z 054 028	sensor oil pressure gauge sender MIT WARNKONTAKT		1	

Model	Year	MG	SG	Illustration	VIN No.	Update	15:32	18.02.20100		ETKA	
ZPA	90	0	05	5-07		336					



Pos	Part Number	Name	Remarks	Qty	Model	Pos	Part Number	Name	Remarks	Qty	Model
-	Z 054 031	sensor installation kit for dynamic oil pressure warning device FUER OELDRUCKGEBER	Z 054 024	1		-	Z 054 077	tempostat system 'COMPACT'	VDO complete	1	
-	Z 054 102	speedometer as required use: sender for vehicle speed	BIS 300 KM/H Z 054 103	1				with: construction use regulations for models with: speedometer also use:	mecanic(ally) Z 054 071		
-	Z 054 096	oil pressure gauge MESSBEREICH: BIS 10 BAR also use: alternatively:	install.: 52mm diameter Z 054 031 Z 054 024 Z 054 028	1 1 1 1		-	Z 054 071	adapter only in combination with: speedometer use for: tempostat system	mecanic(ally) Z 054 077 rear fitting	1	
-	Z 054 097	oil thermometer MESSBEREICH: BIS +150 GRAD C as required use: alternatively:	install.: 52mm diameter Z 054 068 Z 054 049 Z 054 050	1 1 1 1	83> 4 cylinder >89 5 cylinder						
-	Z 054 049	dipstick sensor only for:	338MM Z 054 088 Z 054 020 not for:	1	>83 5 cylinder						
-	Z 054 050	dipstick sensor only for:	522MM Z 054 088 Z 054 020	1	5 cylinder						
-	Z 054 098	quartz watch DURCHLICHTAUSFUEHRUNG	install.: 52mm diameter	1							
-	Z 054 072	quartz watch	'LCD' 12V	1							
-	Z 054 068	temperature sender only for:	Z 054 088 Z 054 020 not for:	1	83> TURBODIESEL						
-	Z 054 068	temperature sender only for:	Z 054 088 Z 054 020 not for:	1	83> TURBODIESEL						
-	Z 054 099	turbo boost pressure indicator	0-3BAR/52MM	1							
-	Z 054 100	voltmeter	8-16V/52MM	1							
-	Z 054 101	water thermometer also use:	12V, MASSEFREI Z 054 047	1							

Model	Year	MG	SG	Illustration	VIN No.	Update	15:32	18.02.20100		ETKA	
ZPA	90	0	05	5-08		336					



Pos	Part Number	Name	Remarks	Qty	Model
		alarm systems			
	000 054 604 D	immobilizer corresponds to the require- ments of insurance companies complete with fitting instruc- tions and fitting material	IMMOBIL CAR ABE VOTEX	1	
-	000 054 613	diesel immobiliser	not for:	1	MVEG II MOTOREN 94> TDI, ecomatic:
-	000 054 603	glass breakage sensor	'VOTEX' only for: 000 054 606 000 054 608	1	
	000 054 608 A	alarm system for vehicles with central locking system as required use:	'CAR ALARM' votex not for:	1	PASSAT 97> squareback 5/97>
		safety pack	000 054 614		
		safety pack	000 054 615		
		ultrasonic module	000 054 616		
		radar module	000 054 617		
		position alarm	000 054 618		
		electronic siren	000 054 628 B		
	000 054 612 A	alarm system for vehicles with immobilizer hand-held transmitter for maximum: additional module as required use:	'CAR ALARM' votex	1	
		ultrasonic module	000 054 616		
		radar module	000 054 617		
		position alarm	000 054 618		
				2	
				3	

Model	Year	MG	SG	Illustration	VIN No.	Update	15:32	18.02.20100		ETKA	
ZPA	90	0	05	5-08		336					



Pos	Part Number	Name	Remarks	Qty	Model	Pos	Part Number	Name	Remarks	Qty	Model
-	000 054 618	electronic siren position alarm	000 054 628 B 'VOTEX' only for: 000 054 604 C 000 054 608 A 000 054 612 A	1							
-	000 054 628 B	electronic siren	'VOTEX' only for: 000 054 604 C 000 054 608 A 000 054 612 A	1							
-	000 054 617	radar module	'VOTEX' only for: 000 054 604 C 000 054 608 A 000 054 612 A	1							
	3B0 054 617	radar protection veh.interior to connect with: anti-theft alarm system complete with fitting instruc- tions and fitting material cable set radar module	votex genuine vw	1	PASSAT 97> PASSAT VARIANT 98>						
-	000 054 616	ultrasonic module	'VOTEX' only for: 000 054 604 C 000 054 608 A 000 054 612 A not for:	1	CABRIOS						

Model	Year	MG	SG	Illustration	VIN No.	Update	15:32	18.02.20100		ETKA	
ZPA	90	0	05	5-09		336					



Pos	Part Number	Name	Remarks	Qty	Model
		other electrical parts			
-	Z 061 802	seat heating	STIMOLL 12V60W	1	
-	Z 061 803	seat heating	'SM 49' STIMOLL 12V50W	1	
	357 054 500	window lifter electric. operated	doors front votex	1	PASSAT 88>93
		with: cable set complete with fitting instruc- tions and fitting material			
	357 054 550	window lifter electric. operated	rear doors votex	1	PASSAT 88>93
		with: cable set complete with fitting instruc- tions and fitting material			
-	Z 054 232	window lifter	'OPZIONAL' front electric	1	88>93
	3A0 054 500	window lifter electric. operated	doors front votex	1	PASSAT 94>
		with: cable set complete with fitting instruc- tions and fitting material			
	3A0 054 550	window lifter electric. operated	rear doors votex	1	PASSAT 94>
		with: cable set complete with fitting instruc- tions and fitting material			
-	Z 054 254	window lifter	'OPZIONAL' front electric	1	94>
-	Z 054 231	window lifter	'OPZIONAL' rear electric	1	88>93
-	357 054 510	switch installation set	VOTEX	1	88>93
-	Z 054 001	fanfare horn electrical system	12V410+500HZ 2-KLANG	1	

Model	Year	MG	SG	Illustration	VIN No.	Update	15:32	18.02.20100		ETKA	
ZPA	90	0	05	5-09		336					



Pos	Part Number	Name	Remarks	Qty	Model	Pos	Part Number	Name	Remarks	Qty	Model
-	Z 054 025	fanfare horn KOMPRESSORFANFARE	12V 3-KLANG	1				with:			
-	Z 054 230	intermittent chip for intermittent wipe		1				electronic control unit			
-	Z 054 240	control unit for intermittent wash-wipe automatic FUER AUTOMATISCHE STEUERUNG DER INTERVALLE JE NACH REGENINTENSITAET	'AWS'	1	AUSSER: PASSAT 97>			hand-held transmitter		2	
-	Z 054 246	electronic parking aid (reversing warner) comprising: multi function indicator ultrasonic sensor not in combination with: towing attachment (ball type)	'PARK BOY III' rear fitting	1				loom			
				1				complete with fitting instruc-			
				3				tions and fitting material			
								for models with:			
								convenience locking (cl+wind.)			
							1J0 054 640	remote control for actuating: convenience locking (cl+wind.) hand-held transmitter electronic control unit cable set mounting instructions	'KOMFORT' bzt approval votex	1	PASSAT 97> PASSAT VARIANT 98>
-	Z 054 247	additional sensor front area also for: from the kit:	rear fitting Z 054 246	1						2	
-	Z 093 085	central locking system for doors comprising:	'IN.PRO.' 2 doors Z 054 251	1			000 054 640	remote control for actuating: central locking system	'KOMFORT' votex both-sides	1	
-	Z 093 086	central locking system for doors comprising:	'IN.PRO.' 4 doors Z 054 251	1				electronic control unit hand-held transmitter loom complete with fitting instruc-	with: bzt approval universal	2	
-	Z 054 251	motor for adjustment only for:	Z 093 085 Z 093 086	1				tions and fitting material			
-	Z 054 251	motor for adjustment only for:	Z 093 085 Z 093 086	1							
-	Z 093 090	remote control for central locking system only for:	'IN.PRO.' Z 093 085 Z 093 086 Z 093 091 Z 054 251	1	PASSAT 32 B			additional module FUER KOFFERRAUMVERRIEGELUNG only for:	Z 093 085 Z 093 086	1	VARIANT 88>93
-	Z 093 091	battery for hand-held only for:	Z 093 090	1				additional module FUER KOFFERRAUMVERRIEGELUNG ODER TANKVERRIEGELUNG only for:	Z 093 085 Z 093 086	1	
	1H0 054 640	remote control for actuating: convenience locking (cl+wind.)	'KOMFORT' bzt approval votex	1	PASSAT 93> VARIANT 93>						

Model	Year	MG	SG	Illustration	VIN No.	Update	15:33	18.02.20100		ETKA	
ZPA	90	0	05	5-10		336					



Pos	Part Number	Name	Remarks	Qty	Model
	357 065 210 A	air conditioner for refrigerant: for vehicles with power steering part corresponds to:	'DIAVIA' R 134A 1 VW 11720 E WAECO	1	PASSAT 88>93 squareback 88>93 1,8 L 55/66/79KW
	357 065 219 A	air conditioner for refrigerant: for models with: POLY-V-RIEMEN part corresponds to:	'DIAVIA' R 134A 1 VW 12720 E WAECO	1	PASSAT 88>93 squareback 88>93 1,8 L 55/66KW
	357 065 214 B	air conditioner for refrigerant: for vehicles with power steering KEILRIEMENANTRIEB part corresponds to:	'DIAVIA' R 134A 1 VW 12920 E WAECO	1	PASSAT 88>93 squareback 88>93 2,0 L 85 KW
	357 065 214 C	air conditioner for refrigerant: for vehicles with power steering POLY-V-RIEMENANTRIEB part corresponds to:	'DIAVIA' R 134A 1 VW 13220 E WAECO	1	PASSAT 88>93 squareback 88>93 2,0 L 85 KW
	357 065 211 A	air conditioner for refrigerant: for vehicles with power steering POLY-V-RIEMENANTRIEB part corresponds to:	'DIAVIA' R 134A 1 VW 13220 E and A 03209	1	PASSAT 88>93 squareback 88>93 1,6L TD 55KW 1,9L D 66KW
	357 065 217 B	air conditioner for refrigerant: for models without: VORMONTIERTEN KOMPRESSOR- TRAEGER (POLY-V-RIEMEN) part corresponds to:	'DIAVIA' R 134A 1 VW 13020 E WAECO	1	PASSAT 88>93 VARIANT 88>93 1,9L 55KW KAT-TD
	357 065 218 A	air conditioner for refrigerant: part corresponds to:	'DIAVIA' R 134A only for: 1 VW 14420 WAECO	1	PASSAT 88>93 squareback 88>93 VR6 2,8L 128KW

Model	Year	MG	SG	Illustration	VIN No.	Update	15:33	18.02.20100		ETKA	
ZPA	90	0	05	5-10		336					



Pos	Part Number	Name	Remarks	Qty	Model	Pos	Part Number	Name	Remarks	Qty	Model
	3A0 065 200	air conditioner for refrigerant: part corresponds to:	'DIAVIA' R 134A 1 VW 12219 E WAECO	1	PASSAT 94> PASSAT VARIANT 94> 1,8L/2,0L 55/66/85 KW						
	3A0 065 203	air conditioner for refrigerant: part corresponds to:	'DIAVIA' R 134A 1 VW 12819 E WAECO	1	PASSAT 94> PASSAT VARIANT 94> 1,9D 55KW						
	3A0 065 204	air conditioner for refrigerant: part corresponds to:	'DIAVIA' R 134A 1 VW 12619 E	1	PASSAT 94> PASSAT VARIANT 94> 1,9L 66KW TDI						

Model	Year	MG	SG	Illustration	VIN No.	Update	15:33	18.02.20100		ETKA	
ZPA	90	0	05	5-11		336					



Pos	Part Number	Name	Remarks	Qty	Model
		stationary heater			
-	Z 054 302 A	stationary heater comprising:	'THERMO TOP' WEBASTO Z 054 306 Z 054 310 Z 451 483 TE also use: Z 054 318	1	otto engine 1,9L> PASSAT B3
-	Z 054 331	stationary heater 'THERMO TOP S' comprising: universal veh.installation kit clock with heater preselector switch for serv. install. use:	WEBASTO 5 KW Z 451 483 TE	1 1 1	otto engine
-	Z 054 333	heater 'AIR TOP 2000' (LUFTHEIZGERAET) TUEV-EINTRAG ERFORDERLICH as required use:	WEBASTO complete 2 KW Z 054 335	1	otto engine
-	Z 054 303 A	stationary heater comprising:	'THERMO TOP' WEBASTO Z 054 306 Z 054 310 Z 451 483 TE also use: Z 054 314 Z 054 318	1	diesel eng. 1,9L> PASSAT B3 PASSAT B3
-	Z 054 332	stationary heater 'THERMO TOP S' comprising: universal veh.installation kit clock with heater preselector switch for serv. install. use:	WEBASTO 5 KW Z 451 483 TE	1 1 1	diesel eng.
-	Z 054 334	heater 'AIR TOP 2000' (LUFTHEIZGERAET) TUEV-EINTRAG ERFORDERLICH as required use:	WEBASTO 2 KW Z 054 335	1	diesel eng.
-	Z 054 306	remote control	'TELESTART T5' WEBASTO only for: Z 054 302 A Z 054 303 A Z 054 331 Z 054 332	1	

Model	Year	MG	SG	Illustration	VIN No.	Update	15:33	18.02.20100		ETKA	
ZPA	90	0	05	5-11		336					



Pos	Part Number	Name	Remarks	Qty	Model	Pos	Part Number	Name	Remarks	Qty	Model
-	Z 054 310	loom	only for: Z 054 302 A Z 054 303 A Z 054 306 Z 054 331 Z 054 332	1			333 054 912	latent heat store for vehicles without air conditioner	votex	1	PASSAT squareback 94>97
-	Z 054 335	clock with heater preselector switch MIT 3-ZEITEN-EINSTELLUNG	WEBASTO only for: Z 054 333 Z 054 334	1					600WH not for:		SYNCRO
-	Z 451 483 TE	pliers ZUM ABKLEMMEN		1							
-	Z 054 320	stationary heater	'TELE THERMO TOP' WEBASTO also use: Z 054 318	1	otto engine PASSAT B3						
-	Z 054 314	installation kit	only for: Z 054 303 A	1	PASSAT B3/ diesel eng.						
-	Z 054 318	installation kit	only for: Z 054 302 A Z 054 320 Z 054 303 A also use: Z 054 319 Z 054 323 Z 054 324	1	PASSAT B3/ otto engine diesel eng. 4 cylinder VAR.VR6+TDI LIM.VR6+TDI 88>96						
-	Z 054 315	air conditioning kit for vehicles with air condit.		1							
-	Z 054 319	installation kit FUER WASCHBEHAELTER	only for: Z 054 318 not for:	1	4 cylinder VR6/TDI						
-	Z 054 323	installation kit FUER WASCHBEHAELTER	only for: Z 054 318	1	VARIANT VR6/TDI						
-	Z 054 324	installation kit FUER WASCHBEHAELTER	only for: Z 054 318	1	sedan VR6/TDI						
		latent heat store									

Model	Year	MG	SG	Illustration	VIN No.	Update	15:35	18.02.20100		ETKA	
ZPA	90	0	10	10-03		336					



Pos	Part Number	Name	Remarks	Qty	Model
	6N0 071 492 C	wheel disc 'alum' construction use regulations	genuine vw 5,5J X 13 ET38 LK100/4 4-spokes FOX with: 6N4 071 213 (666) wheel index: KU genuine vw	1	PASSAT 32B
	10/96 666	silver			
	6N4 071 213	hub cover	'VW' to be used for: 6N0 071 492 C (666)	1	
	10/96 666	silver			
	1H6 071 494	wheel disc 'alum' construction use regulations	6 J X 14 ET38 LK100/4 with: REGGAE 7D0 601 165 5-spokes only in combination with: rubber valve standard wheel bolt votex	1	PASSAT >96
	10/96 666	silver			
	6N0 071 499 D	wheel disc 'alum' construction use regulations	6 J X 14 ET38 LK100/4 5-spokes with: 1H9 071 213 (666) only in combination with: rubber valve standard wheel bolt wheel index: KT	1	PASSAT 35I PA SYNCRO 32B-299 35I-299 PA VARIANT 32B,35I, 35I-299
	10/96 12/96 666	silver			
	1H9 071 213	hub cover inscription	genuine vw VW to be used for: 6N0 071 499 D (666)	1	
	10/96 12/96 666	silver			
	3B0 071 490	wheel disc 'alum' construction use regulations	7JX15 ET45 LK112/5 5-spokes for models with: RONDO	1	PASSAT 3B fr.wheel drv

Model	Year	MG	SG	Illustration	VIN No.	Update	15:35	18.02.20100		ETKA	
ZPA	90	0	10	10-03		336					



Pos	Part Number	Name	Remarks	Qty	Model	Pos	Part Number	Name	Remarks	Qty	Model
		rubber valve	genuine vw			10/96	666	silver	wheel index: JW		
		standard wheel bolt				7M0 071 213		hub cover	'VW' aluminium to be used for: 3B0 071 499 (666)	1	
		with:									
		hub cover	3B0 071 213 (666)			10/96	666	silver			
		wheel index: KR									
10/96	666	silver				8/74	666	silver			
	3B0 071 213	hub cover inscription	genuine vw 'VW' to be used for: 3B0 071 490 (666)	1		Z 071 455		hub cover	for wheel disc: Z 071 023 only in combination with: (666)	1	
10/96	666	silver				8/74	666	silver			
	3B0 071 498	wheel disc 'alum'	7 J X 15 ET 45 LK 112/5 BOOGIE 7M0 071 213 (666) 5-spokes genuine vw wheel index: JV	1	PASSAT 3B fr.wheel drv	Z 071 341		wheel disc 'alum'	5,5 J X 13" with: ET 38 LK 100/4 TYP R 25	1	PASSAT/ squareback 35I-299
		with:									
		construction use regulations						hub cover	Z 071 342		
		hub cover						wheel bolt	Z 071 350		
		only in combination with:						rubber valve	or		
		standard wheel bolt						metal valve	RONAL		
		rubber valve						wheel index: J A			
10/96	666	silver						silver			
	7M0 071 213	hub cover inscription	aluminium 'VW' use for: 3B0 071 498 (666)	1		Z 071 342		grease cap	for wheel disc: Z 071 341	1	
10/96	666	silver				Z 071 350		1 set of wheel bolts	for wheel disc: Z 071 341	1	
10/96	666	silver				Z 071 405		wheel disc 'alum'	5,5 J X 13" with: ET 38,LK 100/4 TYP R 26	1	PASSAT/ VARIANT 32B
	1J0 071 212	hub cover inscription	genuine vw 'VW' to be used for: 3B0 071 491 (666)	1				hub cover	Z 071 353		
		with:						wheel bolt	Z 071 343		
		only in combination with:						rubber valve	RONAL		
		standard wheel bolt						wheel index: L D			
		rubber valve									
10/96	666	silver				8/74	666	silver			
	3B0 071 499	wheel disc 'alum'	7 J X 16 ET45 LK112/5 7-spokes 7M0 071 213 (666) SWING genuine vw	1	PASSAT 3B fr.wheel drv	8/74	666	silver			
		with:									
		construction use regulations						1 set of wheel bolts	for wheel disc: Z 071 405 only in combination with: (666)	1	
		hub cover									
		only in combination with:									
		standard wheel bolt									
		rubber valve									

Model	Year	MG	SG	Illustration	VIN No.	Update	15:35	18.02.20100		ETKA	
ZPA	90	0	10	10-03		336					



Pos	Part Number	Name	Remarks	Qty	Model	Pos	Part Number	Name	Remarks	Qty	Model	
	6N0 071 214	hub cover	'VW'	1			Z 071 024	wheel disc 'alum'	6 J X 14" ET 38 LK 100/4 TYP VZ 001 Z 071 025 (666)	1	PASSAT / squareback 35I	
		to be used for:	6N0 071 494 (666)					construction use regulations hub cover only in combination with: standard wheel bolt rubber valve	wheel index: I A			
	8/74 666	silver					8/74 666	silver				
	Z 071 001	wheel disc 'alum'	6 J X 14" ET 38 LK 100/4 TYP SKALA I Z 071 003 (666) Z 071 366 ATS	1	PASSAT / squareback 35L		Z 071 025	hub cover	for wheel disc: only in combination with:	Z 071 024 (666)	1	
		with: construction use regulations hub cover only in combination with: wheel bolt rubber valve						wheel index: H J				
	8/74 666	silver					8/74 666	silver				
	Z 071 003	hub cover	for wheel disc: only in combination with:	1			Z 071 444	wheel disc 'alum'	6 J X 14" ET 38 LK 100/4 TYP VZ 010 Z 071 388	1	PASSAT / squareback 35I 35I-299	
		for wheel disc: only in combination with:	Z 071 001 (666)					construction use regulations hub cover standard wheel bolt rubber valve	wheel index: J R			
	8/74 666	silver					8/74 666	silver				
	Z 071 366	1 set of wheel bolts	for wheel disc: only in combination with:	4			Z 071 388	hub cover	for wheel disc: only in combination with:	Z 071 444 (666)	1	
		for wheel disc: only in combination with:	Z 071 001 (666)					for wheel disc: only in combination with:				
	8/74 666	silver					Z 071 468	wheel disc 'alum'	6 J X 14" ET 38 LK 100/4 TYP 30 Z 071 457 (666) Z 071 343 CENTRA	1	PASSAT / squareback 35 I	
		1 set of wheel bolts	for wheel disc: only in combination with:	4				construction use regulations hub cover only in combination with: wheel bolt rubber valve	wheel index: H P			
		for wheel disc: only in combination with:	Z 071 004 (666)				8/74 666	silver				
	8/74 666	silver					Z 071 457	hub cover	for wheel disc: only in combination with:	Z 071 468 (666)	1	
		for wheel disc: only in combination with:	Z 071 004 (666)					for wheel disc: only in combination with:				
	Z 071 354	wheel disc 'alum'	6 J X 14" ET 38 LK 100/4 TYP SPORT Z 071 355 Z 071 366 ATS	1	PASSAT/ squareback 35I		8/74 666	silver				
		with: construction use regulations hub cover wheel bolt rubber valve						for wheel disc: only in combination with:				
		wheel index: J J					Z 071 343	1 set of wheel bolts	for wheel disc: only in combination with:	Z 071 468 (666)	1	
	Z 071 355	hub cover	Z 071 354	1								
		for alum. wheel										
	Z 071 366	1 set of wheel bolts	Z 071 354	4								
		for alum. wheel										

Model	Year	MG	SG	Illustration	VIN No.	Update	15:35	18.02.20100		ETKA	
ZPA	90	0	10	10-03		336					



Pos	Part Number	Name	Remarks	Qty	Model	Pos	Part Number	Name	Remarks	Qty	Model	
	Z 071 027	wheel disc 'alum'	6 J X 14" with: ET 38 LK 100/4 construction use regulations TYP PENTALINE hub cover Z 071 430 wheel bolt Z 071 028 rubber valve EXIP wheel index: I C	1	PASSAT / - VARIANT 35 I			hub cover	Z 071 402			
	8/74 666	silver						wheel bolt	Z 071 340			
	Z 071 028	1 set of wheel bolts for wheel disc: only in combination with:	Z 071 027 (666)	4			8/74 666	centralising nut	Z 071 348			
	Z 071 430	cap for wheels for wheel disc: only in combination with:	Z 071 027 (666)	1				metal valve	EXIP			
	8/74 666	silver						wheel index:	K W			
	Z 071 020	anti-theft lock for wheel disc: only in combination with:	1 SATZ = Z 071 027 (666)	4			8/74 666	silver				
	Z 071 397	wheel disc 'alum'	6 J X 14" with: ET 38,LK 100/4 construction use regulations TYP P-LINE hub cover Z 071 398 wheel bolt Z 071 340 centralising nut Z 071 348 metal valve INTRA wheel index: K X	1	PASSAT / squareback 35 I 35 I-299		Z 071 393	hub cover	lockable for wheel disc: only in combination with: material:	Z 071 392 (666) metal	1	
	8/74 666	silver						hub cover	lockable for wheel disc: only in combination with: material:	Z 071 392 (666) plastic	1	
	Z 071 340	1 set of wheel bolts for wheel disc: only in combination with:	Z 071 397 (666)	1			Z 071 402	1 set of wheel bolts for wheel disc: only in combination with:	Z 071 392 (666)	1		
	Z 071 398	grease cap for wheel disc: only in combination with:	Z 071 397 (666)	1			Z 071 340	centralising nut for wheel disc: only in combination with:	Z 071 392 (666)	1		
	Z 071 348	centralising nut for wheel disc: only in combination with:	Z 071 397 (666)	1			Z 071 348	centralising nut for wheel disc: only in combination with:	Z 071 392 (666)	1		
	Z 071 392	wheel disc 'alum'	6 J X 14" with: ET 38,LK 100/4 construction use regulations TYP 2000+ hub cover Z 071 393 alternatively:	1	PASSAT / squareback 35 I 35 I-299		8/74 666	silver				
							Z 071 455	hub cover for wheel disc: only in combination with:	Z 071 455 (666)	1		
							8/74 666	silver				
							Z 071 036	wheel disc 'alum'	6 J X 14" with: ET 38,LK 100/4 construction use regulations TYP R 24 hub cover Z 071 037 only in combination with: standard wheel bolt rubber valve RONAL wheel index: I G	Z 071 036 (666)	1	PASSAT 35 I
							8/74 666	silver				
							Z 071 037	hub cover for wheel disc: only in combination with:	Z 071 036 (666)	1		
							8/74 666	silver				

Model	Year	MG	SG	Illustration	VIN No.	Update	15:35	18.02.20100		ETKA	
ZPA	90	0	10	10-03		336					



Pos	Part Number	Name	Remarks	Qty	Model	Pos	Part Number	Name	Remarks	Qty	Model
	Z 071 349	wheel disc 'alum'	6 J X 14" ET 38,LK 100/4 TYP R 25 Z 071 342 Z 071 350 RONAL	1	PASSAT/ squareback 35I 35I-299			BREMSTRAEGERRAHMEN,VERSTAERKT	front		
		with: construction use regulations hub cover wheel bolt rubber valve						as required use:	000 071 592		
		wheel index:	J B				8/74 666	silver			
							8/74 666	silver			
	Z 071 350	1 set of wheel bolts for wheel disc:	Z 071 349	1			6N0 071 495	wheel disc 'alum'	6JX14" H2	1	PASSAT
	Z 071 342	grease cap for wheel disc:	Z 071 349	1				only in combination with: standard wheel bolt rubber valve	ET 38 LK 100/4 6-spokes JAZZ		32B-299 35I, 35I-299
	Z 071 352	wheel disc 'alum'	6 J X 14" ET 38,LK 100/4 TYP R 26 Z 071 353 RONAL	1	PASSAT/ VARIANT 32B 32B-299 35I 35I-299			hub cover	with: 6N0 071 214 (666)		
		with: construction use regulations hub cover standard wheel bolt rubber valve						wheel index: install time:	KB 15MIN		
		wheel index:	J I				8/74 666	silver			
	Z 071 353	grease cap use for: wheel disc 'alum'	Z 071 352	1			6N0 071 214	hub cover	'VW' 6N0 071 495 (666)	1	
	8/74 666	silver					8/74 666	silver			
	357 071 490	wheel disc 'alum'	6J X 14" ET 38 LK 100/4 5-spokes 191 071 211 (3ZV) 8A0 071 457 M12 X 1,5	1	PASSAT 32B squareback 35I SYNCRO 32B-299		Z 071 422	wheel disc 'alum'	with: 6,5 J X 14" ET 38,LK 100/4 TYP RA-443	1	PASSAT/ VARIANT 35 I 35 I-299
		with: construction use regulations hub cover						standard wheel bolt			
		only in combination with: metal valve wheel bolt						rubber valve	BBS		
		wheel index:	F I				8/74 666	silver			
	8/74 1ZL	silver					8/74 666	silver metallic			
	191 071 495	wheel disc 'alum'	6J X 14" ET 38 LK 100/4	1	PASSAT 32B,35I		Z 071 380	wheel disc 'alum'	with: 6,5 J X 15" ET 33,LK 100/5 TYP RA-442	1	PASSAT/ squareback 35 I
		with: official approval hub cover						construction use regulations standard wheel bolt			
		only in combination with: rubber valve wheel bolt						rubber valve	BBS		
		wheel index:	F M				8/74 666	silver			
		for models without:					193 071 211	1 set of wheel caps inscription	genuine vw volkswagen 1 set = 4 parts 191 071 491 (1ZL)	1	
								to be used for: wheel disc 'alum'			
	8/74 666	silver					8/74 666	silver			

Model	Year	MG	SG	Illustration	VIN No.	Update	15:35	18.02.20100		ETKA	
ZPA	90	0	10	10-03		336					



Pos	Part Number	Name	Remarks	Qty	Model	Pos	Part Number	Name	Remarks	Qty	Model
	193 071 214	cap for wheels inscription to be used for: wheel disc 'alum'	genuine vw volkswagen replacement pt 191 071 491 (1ZL)	1		-	Z 071 018	wheel disc 'alum' PENTALINE TYP 1576 V comprising:	'EXIP' 7JX15" ET 38,LK 100/4 Z 071 430 666 Z 071 020	1	35 I-299, SYNCRO
	8/74 666	silver		1			8/74 666	silver			
	8/74 666	silver				-	Z 071 430	cap for wheels		1	
	8/74 739	chrome					8/74 666	silver			
	Z 071 011	cap for wheels for wheel disc: only in combination with:	Z 071 010 FKZ	1		-	Z 071 020	anti-theft lock	1 SATZ =	4	
	8/74 666	silver					Z 071 015	wheel disc 'alum' with: construction use regulations hub cover only in combination with: standard wheel bolt rubber valve wheel index:	7 J X 15" ET 36,LK 100/5 TYP R 20 Z 071 467 (666) RONAL H T	1	PASSAT 35 I
	8/74 739	chrome					8/74 666	silver			
	Z 071 366	1 set of wheel bolts for wheel disc: only in combination with:	Z 071 010 FKZ	4			Z 071 467	cap for wheels for wheel disc: only in combination with:	Z 071 015 (666)	1	
	Z 071 310	wheel disc 'alum' with: construction use regulations hub cover only in combination with: wheel bolt rubber valve wheel index:	7 J X 15" ET 38,LK 100/5 TYP SPORT Z 071 443 FKZ Z 071 334 ATS 666 - K C 739 - K D	1	PASSAT/ squareback 35 I		8/74 666	silver			
	8/74 666	silver					8/74 666	silver			
	8/74 739	chrome					8/74 666	silver			
	Z 071 443	cap for wheels for wheel disc: only in combination with:	Z 071 310 FKZ	1		-	1H6 071 213	cap for wheels inscription to be used for: wheel disc 'alum'	'VOTEX' 6N0 071 499 A (666)	1	
	8/74 666	silver					8/74 666	silver			
	8/74 666	silver					3B0 071 492	wheel disc 'alum' with: construction use regulations hub cover only in combination with: standard wheel bolt rubber valve	7 J X 17 ET45 LK112/5 7-spokes 7D0 601 165 LARGO votex	1	PASSAT 3B fr.wheel drv sedan
	8/74 739	chrome					3B0 071 493	wheel disc 'alum' with: construction use regulations hub cover only in combination with: standard wheel bolt rubber valve	7,5J X 17 ET45 LK112/5 3B0 071 214 (666) JIVE votex	1	PASSAT 3B fr.wheel drv
	Z 071 334	1 set of wheel bolts for wheel disc: only in combination with:	Z 071 310 FKZ	1							

Model	Year	MG	SG	Illustration	VIN No.	Update	15:35	18.02.20100		ETKA	
ZPA	90	0	10	10-03		336					



Pos	Part Number	Name	Remarks	Qty	Model	Pos	Part Number	Name	Remarks	Qty	Model
	6N0 071 214	hub cover		1							
		hub cover	to be used for:								
			'VW								
			6N0 071 494								
			(666)								
			6N0 071 495								
			(666)								
	8/74	666 silver									

Model	Year	MG	SG	Illustration	VIN No.	Update	15:35	18.02.20100		ETKA	
ZPA	90	0	10	10-06		336					



Pos	Part Number	Name	Remarks	Qty	Model
		wheel locks			
	000 071 594	set of wheel bolts lockable		1	VOLKSWAGEN AUDI
	000 071 593	set of wheel bolts lockable	votex	1	VOLKSWAGEN AUDI
		comprising:	not for:		TRANSPORTER SHARAN
-	Z 071 461	wheel lock set	for:	1	
			WERKSALU,ATS, BBS,CENTRA, TEVOG,INTRA, WKING,SLW 5 C		
		comprising:			
		wheel bolt		4	
		socket wrench for		1	
		wheel bolts			
		cap	chromed	1	
		KAPPENABZIEHER		1	
-	Z 071 464	wheel lock set	for:	1	
			MSW 1934 B, 1908 A,1956 E, WKING L21 B, L 98 B,1225 B		
		comprising:			
		wheel bolt		4	
		socket wrench for		1	
		wheel bolts			
		cap	chromed	1	
		KAPPENABZIEHER		1	
-	Z 071 463	wheel lock set	for:	1	

Model	Year	MG	SG	Illustration	VIN No.	Update	15:35	18.02.20100		ETKA	
ZPA	90	0	10	10-06		336					



Pos	Part Number	Name	Remarks	Qty	Model	Pos	Part Number	Name	Remarks	Qty	Model
			WERKSALU OZ, ITALA 07C,02C, RIAL,WKING 21B 26 A,25 B, MSW 33								
		comprising:									
		wheel bolt		4							
		socket wrench for		1							
		wheel bolts									
		cap	chromed	1							
		KAPPENABZIEHER		1							
	000 071 591 A	set of wheel bolts lockable	M14X1,5X27,5 4 STUECK black	1							
	000 071 592	wheel bolt lock as anti-theft protection	SATZ	1							
		to be used for:	M12								
		standard wheel bolt	genuine vw								
		comprising:									
		wheel bolt	M12	4							
		cap		4							
		adapter		2							
		(SCHLUESSEL)									
		KAPPENABZIEHER		2							

Model	Year	MG	SG	Illustration	VIN No.	Update	15:39	18.02.20100		ETKA	
ZPA	90	0	10	10-07		336					



Pos	Part Number	Name	Remarks	Qty	Model
		wheel trim			
Z	071 436	1 set of wheel trims use for:	AERO 2000 13" 1 SATZ = 4 STUECK	1	
Z	071 447	1 set of wheel trims use for:	FLAIR 2000 13" 1 SATZ = 4 STUECK	1	
Z	071 446	1 set of wheel trims use for: CSI emblem	CSI 15" 1 SATZ = 4 STUECK	1	
-	Z 071 437	1 set of wheel trims	AERO 2000 14" 1 SATZ = 4 STUECK	1	
Z	071 448	1 set of wheel trims use for:	FLAIR 2000 14" 1 SATZ = 4 STUECK	1	
-	000 071 408	1 set of wheel trims	VOTEX	1	

Model	Year	MG	SG	Illustration	VIN No.	Update	15:39	18.02.20100		ETKA	
ZPA	90	0	10	10-08		336					



Pos	Part Number	Name	Remarks	Qty	Model
		snow chain, starting-off chain			
-	Z 091 484	snow chain	'CORTINA' RUD-MATIC 165-13 165/70-14	1	PASSAT 84>
-	Z 091 551	snow chain rud quickstart	RUD-NR. 02 773 165-13 165/70-14	1	PASSAT10/80> PASSAT 8/84> PASSAT 4/88>
-	Z 091 552	snow chain rud quickstart AB 6,5"-FELGE KEINE VERWENDUNG VON KETTEN MOEGlich	RUD-NR. 02 704 185/70-13 175/70-14	1	PASSAT10/80> PASSAT 8/84> PASSAT 8/84> PASSAT G60 SYNCR0/ VARIANT GT/ 16V/VR6/ -SYNCR0 185/65-14 195/60-14
-	Z 091 516	snow chains (stationary fitt.) AB 6"-FELGE KEINE VERWENDUNG VON KETTEN MOEGlich	'QUICKSTART' RUD-NR. 02 779 195/55-15 RUD	1	PASSAT 4/88> PASSAT G60 SYNCR0/ squareback SYNCR0 VARIANT GT/ 16V/VR6

Model	Year	MG	SG	Illustration	VIN No.	Update	15:39	18.02.20100		ETKA	
ZPA	90	0	10	10-08		336					



Pos	Part Number	Name	Remarks	Qty	Model	Pos	Part Number	Name	Remarks	Qty	Model
-	Z 091 532	snow chain	'CORTINA' RUD-MATIC 205/50-15	1	PASSAT 84> PASSAT G60/ SYNCRO, VARIANT SYNC VARIANT GT 16V/VR6	-	Z 091 460	snow chain	195/55-15	1	PASSAT 84> PASSAT G60/SYNCRO, VARIANT SYNC VARIANT GT 16V/VR6
-	Z 091 485	snow chain	'CORTINA' RUD-MATIC 175/70-14	1	PASSAT/ SANTANA 84> PASSAT G60/SYNCRO, VARIANT SYNC VARIANT GT 16V/VR 6	-	Z 091 506	snow chain	'KANTENSPUR' RUD-MATIC 175/70-14	1	PASSAT/ SANTANA 84> PASSAT G60/SYNCRO VARIANT SYNC VARIANT GT 16V/VR 6
-	Z 091 391	snow chain	'KANTENSPUR' RUD-MATIC 165-13	1		-	Z 091 507	snow chain	185/70-13 185/65-14	1	84>
-	Z 091 534	snow chain	'KANTENSPUR' RUD-MATIC 205/50-15	1	PASSAT 84>	-	Z 091 506	snow chain	195/60-14	1	PASSAT/ PASSAT G60/SYNCRO VARIANT SYNC VARIANT GT 16V/VR 6
			205/50-15		PASSAT G60/SYNCRO VARIANT SYNC VARIANT GT 16 V/VR6				'CENTRAX' RUD 165-13 165-13 185/65-14 165/70-14	1	84>
									175/70-14	1	PASSAT G60/SYNCRO VARIANT SYNC VARIANT GT 16/VR 6
									'CENTRAX' RUD 185/70-13 195/60-14 195/55-15	1	84>

Model	Year	MG	SG	Illustration	VIN No.	Update	15:39	18.02.20100		ETKA	
ZPA	90	0	10	10-08		336					



Pos	Part Number	Name	Remarks	Qty	Model	Pos	Part Number	Name	Remarks	Qty	Model
-	Z 091 508	snow chain	'CENTRAX' RUD 185/65-4	1	PASSAT G60/SYNCRO VARIANT SYNC VARIANT GT 16 V/VR6	-	Z 091 491	snow chain	'SPEEDSPUR SUPER' OTTINGER 185/70-13 175/70-14 185/65-14 195/60-14	1	80> 84>
-	Z 091 473	snow chain	'SPEEDSPUR MAXI' OTTINGER 165-13 165/70-14	1		-	Z 091 492	snow chain	'SPEEDSPUR SUPER' OTTINGER 205/50-15	1	PASSAT G60/SYNCRO VARIANT SYNC VARIANT GT 16V/VR6
-	Z 091 474	snow chain	'SPEEDSPUR MAXI' OTTINGER 185/70-13 185/65-14 195/60-14	1		-	Z 091 493	snow chain	'SPEEDSPUR SUPER' OTTINGER 205/60-15	1	PASSAT/ PASSAT G60/SYNCRO VARIANT SYNC VARIANT GT 16V/VR 6
-	Z 091 475	snow chain	'SPEEDSPUR MAXI' OTTINGER 205/50-15	1	PASSAT G60/SYNCRO VARIANT SYNC VARIANT GT 16 V/VR6	-	Z 091 538	snow chain	'SPEEDSPUR SUPER' OTTINGER 195/55-15	1	PASSAT 84> PASSAT G60/SYNCRO VARIANT SYNC VARIANT GT 16V/VR6
-	Z 091 476	snow chain	'SPEEDSPUR MAXI' OTTINGER 205/60-15	1	PASSAT/ PASSAT G60/SYNCRO VARIANT SYNC VARIANT GT Q6V/VR6	-	Z 091 497	snow chain	'SPIKE RING' OTTINGER 165-13 165/70-14	1	84>
-	Z 091 490	snow chain	'SPEEDSPUR SUPER' OTTINGER 165-13 165/70-14	1		-	Z 091 498	snow chain	'SPIKE RING' OTTINGER 185/70-13 175/70-14 185/65-14 195/60-14	1	84>

Model	Year	MG	SG	Illustration	VIN No.	Update	15:39	18.02.20100		ETKA	
ZPA	90	0	10	10-08		336					



Pos	Part Number	Name	Remarks	Qty	Model	Pos	Part Number	Name	Remarks	Qty	Model
-	Z 091 499	snow chain	185/65-14 195/60-14 175/70-14 195/60-14 'SPIKE RING' OTTINGER 205/50-15 205/50-15	1	84> PASSAT G60/SYNCRO VARIANT SYNC VARIANT GT 16 V/VR6 84> PASSAT 84> PASSAT G60/SYNCRO VARIANT SYNC VARIANT GT 16 V/VR 6						
-	Z 091 541	snow chain	'SPIKE RING' OTTINGER 205/60-15	1	84>						

Model	Year	MG	SG	Illustration	VIN No.	Update	15:40	18.02.20100		ETKA	
ZPA	90	0	15	15-01		336					



Pos	Part Number	Name	Remarks	Qty	Model
		shelves, covers			
-	000 093 100	stowage box		1	
-	1H0 061 123 B	folding armrest complete with fitting instructions and fitting material install time:	'VOTEX' driver's seat right 60MIN	1	PASSAT 94>97 lhd
	4/97 01C	satin black			
-	1H2 061 123 B	folding armrest complete with fitting instructions and fitting material install time:	'VOTEX' driver's seat right 60MIN	1	PASSAT 94>97 rhd
	4/97 01C	satin black			
-	000 051 459 B	trim	only for: ALPHA, BETA, GAMMA, DELTA and 189X58MM	1	
		front panel			
-	Z 061 142	blind for luggage boot	black material: cloth	1	PASSAT VARIANT >88 OHNE HECK- loudspeaker
-	Z 061 145	cover folding cover for boot material:	(folding) TEPPICH	1	PASSAT VARIANT 88>
	8/74 469	anthracite			
-	Z 061 100	stowage box, (lockable) comprising: shelf stowage box writing set bracket for seat belt	'AUTO-MANAGER' black	1	
-	Z 061 101	stowage box use for: stowage box	black Z 061 100	1	
-	Z 061 101	stowage box use for: stowage box	black Z 061 100	1	
-	Z 061 102	insert use for: on-board computer use for: stowage box	BIS 60 CM black Z 061 100	1	

Model	Year	MG	SG	Illustration	VIN No.	Update	15:40	18.02.20100		ETKA	
ZPA	90	0	15	15-01		336					



Pos	Part Number	Name	Remarks	Qty	Model	Pos	Part Number	Name	Remarks	Qty	Model
-	Z 061 124	holder for cup material: for attaching:	'CUP & HOLDER' plastic FUSSRAUM fold-open	1		-	Z 092 631	interior decor dash panel trim	'EVOTEC' burred wood self-adhesive	1	PASSAT 94>96
-	Z 061 122	holder for cup material:	(folding) plastic	1		8/74 004	code key		WURZELNUSS		
	8/74 041	black				-	Z 092 632	interior decor dash panel trim	'EVOTEC' burred wood self-adhesive	1	PASSAT 94>96
-	Z 061 002	anti-theft lock for attaching: steering wheel pedal clutch	'AUTO SAFETY'	1		8/74 004	code key		WURZELNUSS		
		length:	320MM			-	Z 092 634	interior decor dash panel trim	birds eye maple brown self-adhesive	1	PASSAT 97>
-	Z 061 004	anti-theft lock for attaching: steering wheel	'STOPLOCK' KAMEI	1							
		length:	554MM			-	Z 092 635	door trim panel	birds eye maple brown self-adhesive	1	PASSAT 97>
-	Z 061 001	anti-theft lock for attaching: selector lever handle handbrake	'CAR-LOK' yellow	1							
-	Z 071 470	anti-theft lock for attaching: wheel disc	'CLAMP-LOK'	1		-	3B0 072 300	dash panel trim rare wood look decor	self-adhesive glossy 6 part install time: 15MIN	1	PASSAT 97> PASSAT VARIANT 98>
-	Z 062 058	rare wood look decor dash panel trim	WURZELNUSS 7-TEILIG self-adhesive	1	PASSAT notchback 94>96 PASSAT squareback 94>96	-	3B0 072 300	dash panel trim rare wood look decor	self-adhesive glossy 6 part install time: 15MIN	1	PASSAT 97> PASSAT VARIANT 98>
-	Z 062 066	rare wood look decor dash panel trim for vehicles without air conditioner	WURZELNUSS 6-TEILIG self-adhesive	1	PASSAT 97> PASSAT VARIANT 97>	-	Z 061 150	luggage compartment bag material: dimensions:	grey NYLONGEWEBE 100XX26X10 CM 4 parts	1	
-	Z 062 067	rare wood look decor dash panel trim for vehicles with air condit.	WURZELNUSS 6-TEILIG self-adhesive	1	PASSAT 97> PASSAT VARIANT 97>	-	3B5 061 160 A	luggage compartment carbox	shaped to fit (plastic) acid-proof votex not for:	1	PASSAT 97> sedan SYNCRO
-	Z 092 630	interior decor dash panel trim	'EVOTEC' burred wood self-adhesive	1	PASSAT 94>96	-	Z 061 343	luggage compartment carbox use for: luggage boot	'PEX' MIT HOHEM RAND anthracite plastic acid-proof fracture-proof	1	PASSAT 97>
	8/74 004	code key	WURZELNUSS					material:			

Model	Year	MG	SG	Illustration	VIN No.	Update	15:40	18.02.20100		ETKA	
ZPA	90	0	15	15-01		336					



Pos	Part Number	Name	Remarks	Qty	Model	Pos	Part Number	Name	Remarks	Qty	Model
-	Z 061 359	luggage compartment carbox use for: .	'PEX' MIT HOHEM RAND anthracite material: plastic acid-proof fracture-proof	1	PASSAT VARIANT 97>	-	Z 061 200	anti-slip shaped mat for luggage compartement use for: luggage boot material:	'PEX' shaped to fit grey acid-proof plastic fracture-proof	1	PASSAT 88>96
-	Z 061 360	luggage compartment carbox use for: .	'PEX' MIT HOHEM RAND anthracite material: plastic acid-proof fracture-proof	1	PASSAT VARIANT 97>	-	Z 061 201	anti-slip shaped mat for luggage compartement use for: .	'PEX' shaped to fit grey acid-proof plastic fracture-proof	1	PASSAT squareback 88>96
-	Z 061 194	luggage compartment carbox use for: luggage boot material:	'CARBOX' shaped to fit grey plastic acid-proof fracture-proof	1	PASSAT 94>96	-	Z 061 251	anti-slip shaped mat for luggage compartement use for: luggage boot material:	'PEX' shaped to fit grey acid-proof plastic fracture-proof	1	PASSAT 97>
-	Z 061 247	luggage compartment carbox use for: luggage boot material:	'CARBOX' shaped to fit grey plastic acid-proof fracture-proof	1	PASSAT 97>	-	Z 061 365	anti-slip shaped mat for luggage compartement use for: .	'PEX' shaped to fit grey acid-proof plastic fracture-proof	1	PASSAT squareback 97>
-	Z 061 192	luggage compartment carbox use for: .	'CARBOX' shaped to fit grey material: plastic acid-proof fracture-proof	1	PASSAT squareback 88>96	-	Z 061 273	luggage compartment shaped mat use for: luggage boot material: shape:	'CARBOX' shaped to fit grey plastic KLEINE AUTOS acid-proof fracture-proof	1	PASSAT notchback >96
-	Z 061 191	luggage compartment carbox use for: .	'CARBOX' shaped to fit grey material: plastic acid-proof fracture-proof	1	PASSAT squareback 88>96	-	Z 061 253	luggage compartment shaped mat use for: luggage boot material: shape:	'CARBOX' shaped to fit grey plastic KLEINE AUTOS acid-proof fracture-proof	1	PASSAT notchback 97>
-	Z 061 355	luggage compartment carbox use for: .	'CARBOX' shaped to fit grey material: plastic acid-proof fracture-proof	1	PASSAT squareback 97>	-	Z 061 274	luggage compartment shaped mat use for: .	'CARBOX' shaped to fit grey material: plastic KLEINE AUTOS acid-proof fracture-proof	1	PASSAT squareback 88>96
-	Z 061 356	luggage compartment carbox use for: .	'CARBOX' shaped to fit grey material: plastic acid-proof fracture-proof	1	PASSAT squareback 97>						

Model	Year	MG	SG	Illustration	VIN No.	Update	15:40	18.02.20100		ETKA	
ZPA	90	0	15	15-01		336					



Pos	Part Number	Name	Remarks	Qty	Model	Pos	Part Number	Name	Remarks	Qty	Model
-	Z 061 275	luggage compartment shaped mat use for: . . material: shape:	'CARBOX' shaped to fit grey acid-proof plastic KLEINE AUTOS fracture-proof	1	PASSAT squareback 88>96	-	Z 061 065	armrest (leather) for the front seats shelf with cover	'PELIKAN' center grey	1	PASSAT 97>
-	Z 061 276	luggage compartment shaped mat use for: . . material: shape:	'CARBOX' shaped to fit grey acid-proof plastic KLEINE AUTOS fracture-proof	1	PASSAT squareback 88>96						
-	Z 061 362	luggage compartment shaped mat use for: . . material: shape:	'CARBOX' shaped to fit grey acid-proof plastic KLEINE AUTOS fracture-proof	1	PASSAT squareback 97>						
-	>Z 061 364	luggage compartment shaped mat use for: . . material: shape:	'CARBOX' shaped to fit grey acid-proof plastic KLEINE AUTOS fracture-proof	1	PASSAT squareback 97>						
-	Z 061 363	luggage compartment shaped mat use for: . . material: shape:	'CARBOX' shaped to fit grey acid-proof plastic KLEINE AUTOS fracture-proof	1	PASSAT squareback 97>						
-	Z 061 055	centre armrest for the front seats armrest cover (cloth) shelf with cover	'KAMEI' (folding) black	1	PASSAT 88> VARIANT 88>						
-	Z 061 064	armrest (leather) for the front seats Ablagefach mit Deckel	'PELIKAN' center grey	1	PASSAT>96						
-	Z 061 059	centre armrest for the front seats cover for armrest (leather) shelf with cover	grey	1	PASSAT 88>96						

Model	Year	MG	SG	Illustration	VIN No.	Update	15:40	18.02.20100		ETKA	
ZPA	90	0	15	15-02		336					



Pos	Part Number	Name	Remarks	Qty	Model
		luggage locks			
Z	071 295	luggage and dog protective grille material: height: width:	'DG 2000' aluminium adjustable 65 - 114 CM 90 - 150 CM	1	PASSAT squareback
Z	071 223	grille luggage and dog protective grille material:	black metal	1	PASSAT squareback 88>96
Z	071 227	grille luggage and dog protective grille material:	black metal	1	PASSAT squareback 97>
Z	071 298	cargo area protective net with quick tensioner support frame height: width:	adjustable 73 X 100 CM 32 CM 110 CM	1	PASSAT VARIANT 88>
-	333 065 110	luggage net		1	squareback 88>
-	331 017 221 C	net partition HINTER RUECKSITZLEHNE	not for:	1	squareback 81>87 M 070
-	331 017 221 D	net partition HINTER RUECKSITZLEHNE blind for luggage boot	for:	1	squareback 81>87 squareback SYNCRO >87 M 070
-	333 017 221	net partition HINTER VORDERSITZE HINTER DER RUECKSITZBANK	also use: VOTEX 333 017 222 333 017 737 A or 333 017 737	1	squareback 92>97
-	333 017 737 A	1 set of securing parts net partition HINTER VORDERSITZE use for: fitting kit	VOTEX	1	
	333 017 222	net partition for attaching behind: for vehicles without sliding roof also use:	VOTEX front seats 333 017 737 A	1	squareback 92>97

Model	Year	MG	SG	Illustration	VIN No.	Update	15:40	18.02.20100		ETKA	
ZPA	90	0	15	15-02		336					



Pos	Part Number	Name	Remarks	Qty	Model	Pos	Part Number	Name	Remarks	Qty	Model
-	333 017 737	1 set of securing parts net partition HINTER RUECKSITZBANK use for: fitting kit	VOTEX	1							

Model	Year	MG	SG	Illustration	VIN No.	Update	15:41	18.02.20100		ETKA	
ZPA	90	0	15	15-03		336					



Pos	Part Number	Name	Remarks	Qty	Model
		seat cover	genuine vw		
	3B0 061 601	1 set of seat covers (cloth) for the front seats for vehicles with side airbag	only for:	1	PASSAT LIM. 10/96> VAR. 06/97> BASISMODELL COMFORT LINE
		with: head restraint cover			
	10/96 3PJ	light beige			
	10/96 6EQ	black			
	10/96 7ET	flannel grey			
	3B0 061 604	1 set of seat covers (cloth) for the front seats for vehicles with side airbag	only for:	1	PASSAT LIM. 10/96> VAR. 06/97> HIGH LINE TREND LINE
		with: head restraint cover			
	10/96 3PJ	light beige			
	10/96 6EQ	black			
	10/96 7ET	flannel grey			
	3B0 061 672	1 set of seat covers (cloth) for the rear seats for vehicles with center armrest	genuine vw 1/3-2/3 rear	1	PASSAT VAR.06/97>
		as required use: head restraint cover	3B0 061 623	2	
	6/97 3PJ	light beige			
	6/97 6EQ	black			
	6/97 7ET	flannel grey			
	6/97 3PJ	light beige			
	6/97 6EQ	black			
	6/97 7ET	flannel grey			
	3B0 061 666	1 set of seat covers (cloth) for the rear seats for vehicles with three-point seat belts, rear for vehicles without armrest	genuine vw 1/3-2/3 center	1	PASSAT LIM.10/96>
		as required use: head restraint cover	3B0 061 623	3	

Model	Year	MG	SG	Illustration	VIN No.	Update	15:41	18.02.20100		ETKA	
ZPA	90	0	15	15-03		336					



Pos	Part Number	Name	Remarks	Qty	Model	Pos	Part Number	Name	Remarks	Qty	Model
	10/96	3PJ	light beige				10/96	6EQ	black		
	10/96	6EQ	black				10/96	7ET	flannel grey		
	10/96	7ET	flannel grey						seat cover		
	3B0 061 660	1 set of seat covers (cloth) for the rear seats not in combination with: long load aperture for vehicles with center armrest	genuine vw 1/3-2/3 rear	1	PASSAT LIM.10/96>		Z 061 881	seat cover (cloth) for vehicles without side airbag	front seats without KOPFSTUETZE POLYACRYL 1 set = 2 parts	1	
		as required use: head restraint cover	3B0 061 623	2					material:		
	10/96	3PJ	light beige				8/74	001	blue black/bright		
	10/96	6EQ	black				8/74	002	red grey/bright		
	10/96	7ET	flannel grey				Z 061 882	1 set of seat covers (cloth) for sports seat	'HARRIS' 1 set = 2 parts POLYACRYL	1	
	10/96	3PJ	light beige						material:		
	10/96	6EQ	black				8/74	001	blue black/bright		
	10/96	7ET	flannel grey				8/74	002	red grey/bright		
	3B0 061 679	1 set of seat covers (cloth) for the rear seats for vehicles with three-point seat belts, rear for vehicles without armrest	genuine vw 1/3-2/3 center rear	1	PASSAT LIM.10/96>		8/74	001	blue black/bright		
		as required use: head restraint cover	3B0 061 623	3			8/74	001	blue black/bright		
	10/96	3PJ	light beige				8/74	002	red grey/bright		
	10/96	6EQ	black				Z 061 884	1 set of seat covers (cloth) for full head restraint	'HARRIS' 1 set = 2 parts POLYACRYL	1	
	10/96	7ET	flannel grey						material:		
	3B0 061 657	1 set of seat covers (cloth) for the rear seats for vehicles with center armrest	genuine vw RUECKBANK rear	1	PASSAT LIM. 10/96>		8/74	001	blue black/bright		
		as required use:	only for: 3B0 061 623	2	V6 SYNCRO		8/74	002	red grey/bright		
	10/96	3PJ	light beige				Z 061 885	seat cover (cloth) for the front seats for vehicles without side airbag	'HANNA' shaped to fit grey 1 set = 2 parts cotton polyester	1	PASSAT >96
	10/96	6EQ	black						material:		
	10/96	7ET	flannel grey								
	10/96	3PJ	light beige								

Model	Year	MG	SG	Illustration	VIN No.	Update	15:41	18.02.20100		ETKA	
ZPA	90	0	15	15-03		336					



Pos	Part Number	Name	Remarks	Qty	Model	Pos	Part Number	Name	Remarks	Qty	Model
	Z 061 886	1 set of seat covers (cloth) for the rear seats backrest, complete material:	'HANNA' shaped to fit grey cotton polyester	1	PASSAT >96		8/74 528	grey			
	Z 061 887	cover for headrest (cloth) material:	'HANNA' shaped to fit grey cotton polyester 1 set = 2 parts	1	PASSAT >96		8/74 008	gold			
	Z 061 892	seat cover (cloth) for sports seat for vehicles without side airbag material:	'HANNA' shaped to fit grey 1 set = 2 parts cotton polyester	1	PASSAT >96		8/74 528	grey			
	Z 061 834	seat cover (artif.fur stretch) for the front seats OHNE KOPFSTUETZEN	POLYACRYL 6MM	1			Z 061 950	wooden sphere seat support for the front seats		1	
	8/74 008	gold					Z 061 956	lumbar support FUER ALLE PKW-SITZE	'KAMEI' black adjustable	1	
	8/74 528	grey					Z 061 954	neckrest material:	'TECHNO' VISKOSE POLYAMID BUNT WASCHBAR	1	
	Z 061 835	seat cover (artif.fur stretch) for the rear seats	POLYACRYL 6MM 1 part	1	NICHT FUER: FZG. MIT GETEILTER RUECKSITZ- BANK		Z 061 955	travel rug material:	'KAMEI' 120 X 180 CM SCHOTTENMUSTER red	1	
	8/74 008	gold									
	8/74 528	grey									
	Z 061 799	seat cover (artif.fur stretch) for full head restraint	POLYACRYL 6MM 1 set = 2 parts	1							
	8/74 008	gold									
	8/74 528	grey									
	Z 061 831	lamb's wool seat cover for the front seats OHNE KOPFSTUETZEN SCHURHOEHE:	1 set = 2 parts 20MM	1							
	8/74 008	gold									

Model	Year	MG	SG	Illustration	VIN No.	Update	15:41	18.02.20100		ETKA	
ZPA	90	0	15	15-04		336					



Pos	Part Number	Name	Remarks	Qty	Model
		carpets, foot mats			
		foot mat	rubber		
Z	061 591	saucer-shaped foot mat material:	left front plastic anthracite	1	PASSAT >81/ VARIANT >81
Z	061 596	saucer-shaped foot mat material:	right front plastic anthracite	1	PASSAT >81/ VARIANT >81
Z	061 595	saucer-shaped foot mat material:	rear plastic anthracite	1	PASSAT >81/ VARIANT >81
Z	061 593	saucer-shaped foot mat material:	left front plastic anthracite	1	PASSAT 81>88/ squareback 81>88 SANTANA
Z	061 583	saucer-shaped foot mat material:	right front plastic anthracite	1	PASSAT 81>88/ squareback 81>88 SANTANA
Z	061 583	saucer-shaped foot mat material:	rear plastic anthracite	1	PASSAT 81>88/ squareback 81>88 SANTANA
Z	061 587	saucer-shaped foot mat for models with driver's seat adjustable for height material:	left rear plastic anthracite	1	PASSAT 81>88/ squareback 81>88 SANTANA
Z	061 569	saucer-shaped foot mat material:	left front plastic anthracite	1	PASSAT / squareback 88>96
Z	061 570	saucer-shaped foot mat material:	right front plastic anthracite	1	PASSAT / squareback 88>96
Z	061 598	saucer-shaped foot mat material:	rear plastic anthracite	1	PASSAT / squareback 88>96
Z	061 572	saucer-shaped foot mat material:	left front plastic anthracite	1	PASSAT / squareback 97>

Model	Year	MG	SG	Illustration	VIN No.	Update	15:41	18.02.20100		ETKA	
ZPA	90	0	15	15-04		336					



Pos	Part Number	Name	Remarks	Qty	Model	Pos	Part Number	Name	Remarks	Qty	Model
	Z 061 573	saucer-shaped foot mat material:	right front plastic anthracite	1	PASSAT / squareback 97>	-	3A0 061 511	rubber mat	rear	1	PASSAT LIMOUSINE/ VARIANT 88>
	Z 061 598	saucer-shaped foot mat material:	rear plastic anthracite	1	PASSAT / squareback 97>		8/74 041	black			
							8/74 528	grey			
-	000 061 511	foot mat	rubber rear	1	PASSAT	-	333 061 521	foot mat	rubber left front	1	PASSAT STUFENHECK VARIANT 88>
					SCHRAEGHECK VARIANT 81>87 VARIANT SYNCRO >87 STUFENHECK 85>87		8/74 041	black			
-	321 061 501	rubber mat	front	1	PASSAT	-	333 061 522	foot mat	rubber right front	1	PASSAT STUFENHECK VARIANT 88>
					SCHRAEGHECK 81>87 VARIANT 81>87 VARIANT SYNCRO >87 STUFENHECK 85>87		8/74 041	black			
					not for: automatic	-	333 061 524	foot mat	rubber right rear	1	PASSAT STUFENHECK VARIANT 88>
	8/74 041	black					8/74 041	black			
	8/74 528	grey				-	000 061 500	foot mat reversible mat in textile look (for export only)	rubber front	2	PASSAT/VAR. >10/80
	8/74 041	black					8/74 041	black			
	8/74 528	grey				-	000 061 510	foot mat reversible mat in textile look	rubber rear	2	PASSAT/VAR. >10/80
-	357 061 501	rubber mat	front	1	PASSAT LIMOUSINE/ VARIANT 88>		3B1 061 501	rubber mat	front left/right shaped to fit 1 set = 2 parts genuine vw	2	PASSAT 97> PASSAT VARIANT 98>
	8/74 041	black					10/96 041	black			
	8/74 528	grey					10/96 528	grey			
							3B2 061 501	rubber mat	front left/right shaped to fit 1 set = 2 parts	2	PASSAT 97> PASSAT VARIANT 98> rhd
							4/97 041	black			

Model	Year	MG	SG	Illustration	VIN No.	Update	15:41	18.02.20100		ETKA	
ZPA	90	0	15	15-04		336					



Pos	Part Number	Name	Remarks	Qty	Model	Pos	Part Number	Name	Remarks	Qty	Model
	10/96 041	black					333 061 226 E	textile mats		1	PASSAT
	10/96 528	grey						attachment knobs	with: rear shaped to fit velours		'EXKLUSIV'
	3B0 061 580	rubber mat cover for tunnel	rear genuine vw	1	PASSAT 97> PASSAT VARIANT 98>			(for export only)	1 set = 2 parts genuine vw		
	10/96 041	black					5/73 CLB	black			
	10/96 528	grey					5/73 CLC	sahara			
	Z 061 079	1 set floor mats	rubber black shaped to fit 4-part	1	PASSAT 88>95		357 061 225	textile mats		4	PASSAT CL, GL, GT, VR6 88>93 VARIANT CL, GL, GT, VR6 88>93
	Z 061 080	1 set floor mats	rubber black shaped to fit 4-part	1	PASSAT 96>		5/73 333	grey			
		textile mats					5/73 469	anthracite			
-	3A1 061 225	textile mats	front/rear velours shaped to fit genuine vw front	4	PASSAT 88>96 squareback 88>96		Z 061 775	set car carpets shaped to fit	'TECHNO TOP' shaped to fit POLYPROPYLEN 4-part	1	PASSAT 97>
		attachment knobs	with: front		PACIFIC		5/73 469	anthracite			
			also for:				Z 061 315	set car carpets shaped to fit	'TECHNO IDEAL' shaped to fit velours 4-part	1	PASSAT 88>96 PASSAT VARIANT 88>
	5/73 5FY	black					5/73 469	anthracite			
	5/73 9VY	platinum					Z 061 347	set car carpets shaped to fit	'TECHNO IDEAL' shaped to fit velours 4-part	1	PASSAT 97>
	5/73 G20	mauritius blue			DAVOS 96		5/73 469	anthracite			
	5/73 JAW	black/black			CLASSIC LINE		-	3A1 061 228	textile mats	4	PA 94> PA VAR.94>
	333 061 225 E	textile mats	front shaped to fit velours	1	PASSAT 'EXKLUSIV'		5/73 5FY	black			
		attachment knobs	1 set = 2 parts genuine vw VR6				-	3A1 061 227 E	textile mats MIT BEFESTIGUNG VORNE	1	PASSAT HIGHLAND CLASSIC-LINE
		inscription (for export only)					5/73 EGY	sahara	1 set = 4 parts		
	5/73 CLC	sahara									

Model	Year	MG	SG	Illustration	VIN No.	Update	15:41	18.02.20100		ETKA	
ZPA	90	0	15	15-04		336					



Pos	Part Number	Name	Remarks	Qty	Model	Pos	Part Number	Name	Remarks	Qty	Model
-	3A0 061 225 E	textile mats 1 set textile mats,shap.to fit	front/rear 1 set = 4 parts	1	PA DAVOS 96> PA VARIANT DAVOS 96>						
	5/73	G20 mauritius blue									
	9/96	FBN grey black/black									
	9/96	FBP light beige									
	3B1 061 225	1 set textile mats,shap.to fit	front/rear shaped to fit velours POLYAMID 1 set = 4 parts genuine vw	1	PASSAT 97> PASSAT VARIANT 98>						
	10/96	B98 satin black									
	10/96	9UW sahara									
	10/96	U71 flannel grey									
	3B0 061 494	attachment knob use for: foot mat mounting instructions	genuine vw	4	PASSAT 97>						
				2							
	3B0 061 493	attachment element use for: foot mat	genuine vw	4	PASSAT LIM. 97>						
				2	VAR. 98>						
	10/96	FBN grey black/black									
	10/96	FBP light beige									
	10/96	FHR flannel grey									
-	4A1 061 493	attachment knob	black	4							
-	000 072 035	slip stop	60X110CM	1							
	8/74	469 anthracite									
	Z 061 241	anti-slip mat for securing the load to prevent it slipping	'CARBOX' black plastic dimensions: 120 X 100 CM	1							

Model	Year	MG	SG	Illustration	VIN No.	Update	15:41	18.02.20100		ETKA	
ZPA	90	0	15	15-05		336					



Pos	Part Number	Name	Remarks	Qty	Model
		child seats, sports seats			
	000 019 900 B	child seat system for children in the age of: for children weighing: for models with: three-point seat belt	BOBSY G 0 genuine vw >9 MONATE >10 KG rear frnt pass seat	1	VOLKSWAGEN
	000 019 901 B	child seat system for children in the age of: for children weighing: for models with: 2 point seat belt three-point seat belt	BOBSY G 1 8 MON -4 JAHRE 9 KG - 18 KG	1	VOLKSWAGEN
	000 019 902 B	child seat system for children in the age of: for children weighing: for models with: three-point seat belt	BOBSY G 1-3 9 MON-12 JAHRE 9 - 36 KG	1	VOLKSWAGEN
	000 019 903 B	child seat system for children in the age of: for children weighing: for models with: 2 point seat belt three-point seat belt	BOBSY G 2 3,5 - 7 JAHRE 15 - 25 KG	1	VOLKSWAGEN
	000 019 904 B	child seat system for children in the age of: for children weighing: for models with: three-point seat belt as required use: sleep restraint	BOBSY G 3 4 - 12 JAHRE 17 - 36 KG genuine vw	1	VOLKSWAGEN
	000 019 905 B	sleep restraint only in combination with: child seat system	BOBSY G 3 genuine vw BOBSY G 3 000 019 904 B	1	VOLKSWAGEN
	000 019 893	headrest	only for: 000 019 800	1	
	8/74 L31	grey/green red blue			
	000 019 894	sun blind - roof panel		1	
	8/74 L31	grey/green red blue			
	000 019 799	belt attachment bracket only for:	replacement pt 000 019 800 A	1	

Model	Year	MG	SG	Illustration	VIN No.	Update	15:41	18.02.20100		ETKA	
ZPA	90	0	15	15-05		336					



Pos	Part Number	Name	Remarks	Qty	Model	Pos	Part Number	Name	Remarks	Qty	Model
	Z 019 942	child's seat 2 point seat belt and/or three-point seat belt rear seat	'ROEMER-VARIO' FUER KINDER: 3,5 - 7 JAHRE 15 - 25 KG MOTIV: TWIST	1							
	8/74 610	baltic blue/azure									
	Z 019 935	child's seat use for: 3-PUNKT-STATIK ODER AUTOMATIKGURT	'STAR RISER' FUER KINDER: 3 - 12 JAHRE 17 - 36 KG	1							
	8/74 610	baltic blue/azure									
	Z 019 900	child's seat for 1st bike for children weighing: as required use: bracket	'ROEMER SULKY' 15 KG blue	1							
	Z 019 904	bracket use for: child's seat	Z 019 904 Z 019 900	1							
	Z 019 907	child's seat for 1st bike for children weighing: as required use: bracket	'ROEMER JOCKEY RELAX' 22 KG blue adjustable	1							
	Z 019 907	child's seat for 1st bike for children weighing: as required use: bracket	'ROEMER JOCKEY RELAX' 22 KG blue adjustable	1							
	Z 019 905	bracket use for: child's seat	Z 019 905 Z 019 907	1							

Model	Year	MG	SG	Illustration	VIN No.	Update	15:42	18.02.20100		ETKA	
ZPA	90	0	15	15-06		336					



Pos	Part Number	Name	Remarks	Qty	Model
		louvers, sun blinds, glare protection, tinted sheeting			
Z	064 170	sun visor use for: washer for attaching:	4-FARBIG STRANDMOTIV dash panel	1	
Z	064 183	roller blind for rear window for vehicles with outer mirror for passenger	2-part 100 CM BREITE	1	PASSAT >81 PASSAT 81>88
Z	064 186	roller blind for rear window for vehicles with outer mirror for passenger	1 part 100 CM BREITE trapezoidal	1	PASSAT 81>88
Z	064 187	roller blind for rear window for vehicles with outer mirror for passenger	1 part 110 CM BREITE	1	PASSAT 88>96 NICHT FUER: FZG. MIT HECKWISCHER
3B0	064 160 A	roller blind for rear window for vehicles with outer mirror for passenger complete with fitting instructions and fitting material	shaped to fit votex	1	PASSAT 97> sedan
3B5	064 162	roller blind for door window for vehicles with outer mirror for passenger	rear left/right	2	PASSAT 97> sedan
3B9	064 160	roller blind for rear window for vehicles with outer mirror for passenger complete with fitting instructions and fitting material	shaped to fit votex	1	PASSAT 98> squareback
3B9	064 162	roller blind for door window for vehicles with outer mirror for passenger	rear left/right	2	PASSAT 98> squareback
Z	064 194	roller blind for rear window for vehicles with outer mirror for passenger	1 part 110 CM BREITE trapezoidal	1	PASSAT 88>96
Z	064 186	roller blind for rear window for vehicles with outer mirror for passenger	1 part 100 CM BREITE trapezoidal	1	PASSAT 97>

Model	Year	MG	SG	Illustration	VIN No.	Update	15:42	18.02.20100		ETKA	
ZPA	90	0	15	15-06		336					



Pos	Part Number	Name	Remarks	Qty	Model	Pos	Part Number	Name	Remarks	Qty	Model
-	000 064 160	roller blind for rear window	2-part 90CM trapezoidal	1	STUFENHECK 85>88	Z	064 199	sun blind - roof panel for vehicles with side window for vehicles with outer mirror for passenger	'SPRINGSHIELD' 44 X 36 CM GAZE 1 SAUGER (folding)	1	
	8/74 090	code key									
	357 064 160 A	roller blind for rear window for vehicles with outer mirror for passenger	1 part trapezoidal	1	PASSAT 88> notchback	Z	064 196	sun protection strip use for: WINDSCHUTZSCHEIBE	140 X 20 CM self-adhesive TÜV-FREI	1	
		also use: connecting strip	357 867 617 A								
	357 867 617 A	connecting strip for vehicles with roller blind		1							
	8/74 3UK	pastel beige									
	8/74 1DH	light grey									
-	000 064 166	roller blind for door window	rear width: 48CM	1	PASSAT						
	Z 064 184	roller blind for door window for vehicles with outer mirror for passenger	45 CM BREITE GAZE ZUM EINHAENGEN UND 1 SAUGER	1							
	Z 064 184	roller blind for door window for vehicles with outer mirror for passenger	45 CM BREITE GAZE ZUM EINHAENGEN UND 1 SAUGER	1							
	Z 064 182	sun blind - roof panel for vehicles with side window for vehicles with outer mirror for passenger	50 X 45 CM foil MIT SAUGERN	1							
	Z 064 181	sun blind - roof panel for vehicles with side window for vehicles with outer mirror for passenger	50 X 45 CM REFLEKTIEREND ZUM EINHAENGEN UND 2 SAUGERN	1							
	Z 064 188	sun blind - roof panel for vehicles with side window for vehicles with outer mirror for passenger	'SUN LUX' 40 X 31 CM REFLEKTIEREND self-adhesive	1							

Model	Year	MG	SG	Illustration	VIN No.	Update	15:42	18.02.20100		ETKA	
ZPA	90	0	15	15-07		336					



Pos	Part Number	Name	Remarks	Qty	Model
	Z 072 541	mirror interior rear view mirror, automatic anti-dazzle	volt/ah: 12 V/ 1,25 AMP REAKTIONSZEIT: 0,5 SEC.	1	
	Z 072 540	panorama and wide-angle interior mirror housing rear view mirror inner	dimensions: 220 X 65 MM plastic black GEWOELBT BLENDFREI	1	

Model	Year	MG	SG	Illustration	VIN No.	Update	15:43	18.02.20100		ETKA	
ZPA	90	0	15	15-08		336					



Pos	Part Number	Name	Remarks	Qty	Model
		fresh air filter			
-	357 091 401	dust and pollen filter set comprising:	lhd 357 091 700 357 091 720 also use: 357 091 409 357 091 413	1	PASSAT 90>91
-	357 091 401	dust and pollen filter set comprising:	lhd 357 091 700 357 091 720 also use: 357 091 413	1	PASSAT 91>
-	357 091 700	filter element		1	
-	357 091 720	filter housing		1	
-	357 091 409	water deflector		1	8/90>2/91
-	357 091 413	water deflector comprising:	357 091 410 357 091 412 357 091 411	1	
-	357 091 410	water deflector	right	1	
-	357 091 412	water deflector	center	1	
-	357 091 411	water deflector	left	1	
	321 091 400	fresh air filter for car interior for vehicles without air conditioner filter gasket mounting instructions	only for:	1	PASSAT fastback squareback 81>88 notchback 85>87 lhd
Z	062 104	fresh air filter for car interior for vehicles without air conditioner	SYSTEM MIT AKTIVKOHLE TUEV-FREI	1	PASSAT >88
		replacement fresh air filter	Z 062 105		
Z	062 105	replacement fresh air filter use for:	Z 062 104	1	PASSAT >88

Model	Year	MG	SG	Illustration	VIN No.	Update	15:43	18.02.20100		ETKA	
ZPA	90	0	15	15-08		336					



Pos	Part Number	Name	Remarks	Qty	Model	Pos	Part Number	Name	Remarks	Qty	Model
	Z 062 108	fresh air filter for car interior	SYSTEM MIT AKTIVKOHLE TUEV-FREI	1	PASSAT/ squareback 88>						
		replacement fresh air filter	Z 062 109								
	Z 062 109	replacement fresh air filter use for:	Z 062 108	1	PASSAT/ squareback 88>						
	Z 062 121	filter check system ZUR UEBERPRUEFUNG DER FRISCH- LUFTFILTERLEISTUNG		1	PASSAT 94>						
-	3A0 091 800	particulate filter	genuine vw	1	PASSAT 94>						
	3B0 091 800	particulate filter	genuine vw	1	PASSAT 97> PASSAT VARIANT 97>						

Model	Year	MG	SG	Illustration	VIN No.	Update	15:43	18.02.20100		ETKA	
ZPA	90	0	20	20-01		336					



Pos	Part Number	Name	Remarks	Qty	Model
		mirror			
	Z 072 592	caravan mirror with clamp fitting	adjustable 1 set = 2 parts	1	PASSAT / squareback 88>9/96
	Z 072 542	caravan mirror with clamp fitting	adjustable 1 set = 2 parts	1	PASSAT 10/96>3/97
	Z 072 606	caravan mirror with clamp fitting	adjustable 1 set = 2 parts	1	PASSAT 4/97>
	Z 072 582	caravan mirror with clamp fitting	'CLIP-ON' adjustable	1	
	Z 072 596	caravan mirror with clamp fitting	'HUCKEPACK 3' adjustable 1 set = 2 parts	1	
		replacement:	Z 072 586		
	Z 072 586	replacement head use for: caravan mirror	Z 071 596	1	

Model	Year	MG	SG	Illustration	VIN No.	Update	15:43	18.02.20100		ETKA	
ZPA	90	0	20	20-02		336					



Pos	Part Number	Name	Remarks	Qty	Model
		covers			
	Z 061 129	car cover with quick tensioner hook for strap	NYLONGEWEBE	1	PASSAT SANTANA NICHT FUER: squareback
	Z 061 130	car cover with quick tensioner hook for strap	NYLONGEWEBE	1	PASSAT squareback

Model	Year	MG	SG	Illustration	VIN No.	Update	15:44	18.02.20100		ETKA	
ZPA	90	0	20	20-03		336					



Pos	Part Number	Name	Remarks	Qty	Model
		draught deflectors, sun roofs wind deflector			
	Z 072 290	door wind deflector material:	smoke acrylic glass 1 set = 2 parts tuev-tested	1	PASSAT 89>96
	Z 072 293	door wind deflector material:	smoke acrylic glass 1 set = 2 parts tuev-tested	1	PASSAT 97>
-	357 072 195	door wind deflector with clamp fitting	smoke acrylic glass 1 set = 2 parts	2	notchback 89> squareback 89>
	3B0 072 195	door wind deflector with clamp fitting	smoke acrylic glass 1 set = 2 parts	2	PASSAT 97> PASSAT VARIANT 98>
	Z 072 198	wind deflector roof draught deflector for vehicles with sliding roof	acrylic glass smoke	1	PASSAT >88 SANTANA
	Z 072 204	wind deflector roof draught deflector for vehicles with sliding roof	acrylic glass smoke	1	PASSAT 89>96 NICHT FUER: VARIANT 89> LANGER DACH- RELIG
	Z 072 208	wind deflector roof draught deflector for vehicles with sliding roof	acrylic glass smoke	1	PASSAT 97>
	Z 072 205	wind deflector roof draught deflector MIT BELUEFTUNGSKLAPPEN for vehicles with sliding roof	'CLIMACONTROL' acrylic glass smoke	1	PASSAT >88
	Z 072 205	wind deflector roof draught deflector MIT BELUEFTUNGSKLAPPEN for vehicles with sliding roof	'CLIMACONTROL' acrylic glass smoke	1	PASSAT >88
	Z 072 206	wind deflector roof draught deflector MIT BELUEFTUNGSKLAPPEN for vehicles with sliding roof	'CLIMACONTROL' acrylic glass smoke	1	PASSAT 88> NICHT FUER: VARIANT MIT LANGER DACH- RELING

Model	Year	MG	SG	Illustration	VIN No.	Update	15:44	18.02.20100		ETKA	
ZPA	90	0	20	20-03		336					



Pos	Part Number	Name	Remarks	Qty	Model	Pos	Part Number	Name	Remarks	Qty	Model
-	000 072 192	wind deflector for vehicles with sliding roof		1	PASSAT >88	-	000 072 322	cover frame	for: F 300 SOLAR F 400 F 500 F 520	1	
	8/74 594	smoke grey									
-	357 072 192	wind deflector for vehicles with sliding roof		1	PASSAT 88>		8/74 041	black			
	8/74 594	smoke grey					8/74 528	grey light grey			
	3B0 072 192	wind deflector roof draught deflector for vehicles with sliding roof sun roofs	smoke acrylic glass	1	PASSAT 97> PASSAT VARIANT 98>	-	000 072 323	wind deflector smoke grey MIT SCHUTZTASCHE FUER GLASSSCHEIBE	'STANDARD' for: 000 072 223 000 072 225 000 072 227	1	
-	000 072 224	glass tilting roof roller blind	with: 'F 400' VOTEX	1		Z	072 329	glass tilting roof construction use regulations MIT KLAPPGRIFF	SKY TOP 101 WEBASTO 4 speeds 80 MM opening heighth: as required use:	1	
-	000 072 225	glass tilting roof roller blind installation kit comprising:	with: 'F 520' VOTEX 000 072 228	1		Z	072 334	sun vizor use for: glass tilting roof	Z 072 334 grey	1	
-	000 072 525	glass tilting roof	with: 'F 525' ABE votex	1		Z	072 330	glass tilting roof construction use regulations MIT DREHGRIFF	SKY TOP 201 WEBASTO STUFENLOS 77 MM opening heighth: as required use:	1	
	000 072 220	glass tilting roof construction use regulations complete with fitting instructions and fitting material dimensions: opening heighth: single pane safety-glass	CLASSIC tuev-tested votex	1		Z	072 335	sun vizor use for: glass tilting roof	Z 072 335 grey	1	
	000 072 220	glass tilting roof construction use regulations complete with fitting instructions and fitting material dimensions: opening heighth: single pane safety-glass	CLASSIC tuev-tested votex	1		Z	072 326	glass tilding/sliding roof MIT VERSENKBARER KURBEL construction use regulations dimensions: as required use:	'TOP SLIDER MEDIUM' WEBASTO 748 X 378 MM as required use:	1	
	000 072 221	glass sliding/tilting roof roller blind	with: 'F 1000' votex	1		Z	072 327	glass tilding/sliding roof MIT ELEKTRISCHER BETAETIGUNG construction use regulations dimensions: as required use:	'TOP SLIDER MEDIUM' WEBASTO 748 X 378 MM as required use:	1	
-	000 072 327	cover frame	for: 000 072 327	1				sun vizor	Z 072 328		
	8/74 041	black									
	8/74 528	grey									

Model	Year	MG	SG	Illustration	VIN No.	Update	15:44	18.02.20100		ETKA	
ZPA	90	0	20	20-03		336					



Pos	Part Number	Name	Remarks	Qty	Model	Pos	Part Number	Name	Remarks	Qty	Model
	Z 072 328	sun vizor use for: glass tilding/sliding roof	Z 072 326 Z 072 327	1							
	Z 072 331	glass tilding/sliding roof MIT ELEKTRISCHER BETAETIGUNG construction use regulations opening heigth: as required use: sun vizor	'TOP SLIDER LARGE' WEBASTO 48 MM Z 072 333	1							
	Z 072 332	glass tilding/sliding roof MIT VERSENKBARER KURBEL construction use regulations opening heigth: as required use: sun vizor	'TOP SLIDER LARGE' WEBASTO 48 MM Z 072 333	1							
	Z 072 333	sun vizor use for: glass tilding/sliding roof	Z 072 331 Z 072 332	1							
	Z 072 226	folding roof dimensions: as required use: cassette surround	'SUNWAY 2' black/white 760 X 760 MM Z 072 227	1	PASSAT >88						
	Z 072 227	cassette surround use for: folding roof	Z 072 226	1							

Model	Year	MG	SG	Illustration	VIN No.	Update	15:44	18.02.20100		ETKA	
ZPA	90	0	20	20-04		336					



Pos	Part Number	Name	Remarks	Qty	Model
		impact protection strips			
Z	072 497	impact protection strip length:	'KAMEI' 370 MM black self-adhesive 1 set = 2 parts	1	
Z	072 488	impact protection strip length:	'KAMEI' 525 MM black self-adhesive	2	
Z	072 519	front protective decor if necessary paint material:	'KAMEI' black DUROKAM	1	PASSAT 88>94 VARIANT 88>94
8/74	041	black			
Z	072 481	paint protection sheet use for: LADEKANTE	self-adhesive	1	PASSAT squareback >93
8/74	041	black			
8/74	003	transparent transparent			
Z	072 486	paint protection sheet use for: LADEKANTE	self-adhesive	1	PASSAT squareback 94>
8/74	041	black			
8/74	003	wine red transparent			

Model	Year	MG	SG	Illustration	VIN No.	Update	15:44	18.02.20100		ETKA	
ZPA	90	0	20	20-05		336					



Pos	Part Number	Name	Remarks	Qty	Model
-	321 075 110	mud flaps, deflectors mud flap type: comprising:	front 'C' 000 075 120	2	fastback 81>88 notchback 85>88 squareback 81>88 VAR. TOPIC 84>88 VAR. COUNTRY 84>88 TOPIC 84>88
-	321 075 100	mud flap type: comprising:	rear 'C' 000 075 120	2	fastback 81>88 fastback GT 85>88 notchback 85>88 squareback 81>88 VARIANT GT 85>88 VAR. SYNCRO /-GT 85>88 VAR. TOPIC 84>88 VAR. COUNTRY 84>88 TOPIC 84>88 ARENA 85>88

Model	Year	MG	SG	Illustration	VIN No.	Update	15:44	18.02.20100		ETKA	
ZPA	90	0	20	20-05		336					



Pos	Part Number	Name	Remarks	Qty	Model	Pos	Part Number	Name	Remarks	Qty	Model
-	357 075 111	mud flap type: comprising:	front 'E' 000 075 135 A	2	notchback 88>93 squareback 88>93						
-	357 075 101	mud flap type: comprising:	rear 'F' 357 075 120	2	notchback 88>93						
	357 075 101 A	mud flap type:	rear 'F'	2	88>93						
-	3A0 075 111	mud flap type: comprising:	front 'E' 000 075 135 A	2	notchback 94> squareback 94>						
-	3A5 075 101	mud flap type:	rear 'F'	2	notchback 94>						
	3B0 075 111	1 set of mud flaps left and right	front 'E' votex	1	PASSAT 97> PASSAT VARIANT 97>						
	3B0 075 101	1 set of mud flaps left and right	rear 'F' votex	1	PASSAT 97> PASSAT VARIANT 97>						
-	333 075 101	mud flap type: comprising:	rear 'F' 333 075 120	2	squareback 88>93						
-	3A9 075 101	mud flap type:	rear 'F'	2	squareback 94>						
-	000 075 120	attachment clip		1							
-	000 075 135 A	attachment clip		1							
-	357 075 120	attachment clip	short	1							
-	333 075 120	attachment clip	long	1							

Model	Year	MG	SG	Illustration	VIN No.	Update	15:45	18.02.20100		ETKA	
ZPA	90	0	20	20-06		336					



Pos	Part Number	Name	Remarks	Qty	Model
		trim and chrome parts, number plate brackets			
Z	071 231	trim for tail pipe material:	chrome MESSING	1	PASSAT >93 1.6ltr. 1,9L DIESEL
>Z	071 270	trim for tail pipe with solid attachment material: shape:	'BLACK-LINE' aluminium round black	1	PASSAT 81>88 1.05/1.3ltr. DIESEL/LIM./ squareback
Z	071 270	trim for tail pipe with solid attachment material: shape:	'BLACK-LINE' aluminium round black	1	PASSAT 88>93 1,6 / 1,8 / LIM./VARIANT
Z	071 270	trim for tail pipe with solid attachment material: shape:	'BLACK-LINE' aluminium round black	1	PASSAT 90>93 1,9 DIESEL
Z	071 273	trim for tail pipe with solid attachment material: shape:	'BLACK-LINE' aluminium oval black	1	PASSAT 81>88 1,5 / 1,6 / DIESEL / LIM. / squareback
Z	071 273	trim for tail pipe with solid attachment material: shape:	'BLACK-LINE' aluminium oval black	1	PASSAT 88>93 1,6 / 1,8 / LIM. / squareback
Z	071 273	trim for tail pipe with solid attachment material: shape:	'BLACK-LINE' aluminium oval black	1	PASSAT 90>93 1,9 DIESEL
Z	071 278	trim for tail pipe with solid attachment material: shape:	'BLACK-LINE' aluminium angular black	1	PASSAT 81>88 1,5 / 1,6/ LIM. / squareback
Z	071 278	trim for tail pipe with solid attachment material: shape:	'BLACK-LINE' aluminium angular black	1	PASSAT 88>93 1,6 / 1,8 / LIM. / squareback

Model	Year	MG	SG	Illustration	VIN No.	Update	15:45	18.02.20100		ETKA	
ZPA	90	0	20	20-06		336					



Pos	Part Number	Name	Remarks	Qty	Model	Pos	Part Number	Name	Remarks	Qty	Model
	Z 071 278	trim for tail pipe with solid attachment	'BLACK-LINE'	1	PASSAT 90>93 1,9 DIESEL						
		material: shape:	aluminium angular black								
	Z 071 300	trim for tail pipe		1							
		material:	MESSING								
	Z 071 301	trim for tail pipe		1							
		material:	40-52MM MESSING								
-	357 052 220	trim		1	notchback 88>						
-	333 052 213 B	rear trim centre trim panel	yellow/red	1	squareback 88>						
-	Z 071 056	door handle shield	bright chrome 1 set = 2 parts bright chrome	1	PASSAT 88>93 squareback 89>93						
	Z 071 055	door handle shield	black 1 set = 2 parts	1	PASSAT 88>93 PASSAT squareback 89>93						
-	Z 071 071	door handle shield	bright chrome 1 set = 2 parts	1	squareback 81>88						
-	Z 071 072	door handle shield	black matt 1 set = 2 parts black	1	squareback 81>88						

Model	Year	MG	SG	Illustration	VIN No.	Update	15:45	18.02.20100		ETKA	
ZPA	90	0	20	20-07		336					



Pos	Part Number	Name	Remarks	Qty	Model
-	Z 092 624	decor sets			
	8/74 001	exterior decor	'STRUCTURE'	1	
	8/74 002	blue			
	8/74 003	green			
	8/74 007	wine red			
	8/74 007	yellow			
	8/74 469	anthracite			
-	Z 092 610	decor set	'TITAN READY'	1	PASSAT squareback 88>93
	8/74 190	light blue metallic			
	8/74 191	anthracite/red			
-	Z 092 614	decor set	'TOP STYLE'	1	
	8/74 196	anthracite/red			
	8/74 334	atlas grey metallic/cherry red			
-	Z 092 615	decor set	'TOP STYLE'	1	
	8/74 197	silver/pink			
	8/74 198	black/violet			
	8/74 199	ivory			
-	Z 092 616	decor set	'TOP STYLE'	1	
	8/74 200	black/multicolour			
	8/74 201	violet/turquoise			
	8/74 202	silver turquoise			

Model	Year	MG	SG	Illustration	VIN No.	Update	15:46	18.02.20100		ETKA	
ZPA	90	0	25	25-01		336					



Pos	Part Number	Name	Remarks	Qty	Model
		towing device			
-	321 092 115 D	rigid towing device	not for: also use: 000 055 208 B	1	PASSAT 81-84 VARIANT
-	3A0 092 101	rigid towing device	also use: 3A5 055 203 3A5 055 204 3A9 055 203 3A9 055 204	1	PASSAT sedan 94>96 squareback 94>97
-	331 092 116 B	rigid towing device ANHAENGERLAST 1900 KG	also use: 000 055 208 B	1	PASSAT squareback 81>88 SYNCRO 85>88
-	357 092 115 A	rigid towing device for vehicles with self-levelling system	also use: 357 055 204 357 055 203	1	PASSAT 88>93 SYNCRO 89>93
-	357 092 155 A	detachable towing device for vehicles with self-levelling system	also use: 357 055 204 also use: 357 092 761 357 092 762	1	PASSAT 88>93 SYNCRO 89>93
-	3A0 092 155	detachable towing device	also use: 3A9 055 203 3A9 055 204 3A5 055 203 3A5 055 204	1	PASSAT squareback 94>96 sedan 94>96
	3B0 092 101	rigid towing device as required use: electrical install kit 7-pin electr.installation kit 13-pin	genuine vw 3B0 055 203 B 3B0 055 204 B	1	PASSAT LIM. 97> VAR. 98>
	3B0 092 101 A	rigid towing device as required use: electrical install kit 7-pin electr.installation kit 13-pin	genuine vw 3B0 055 203 B 3B0 055 204 B	1	PASSAT LIM. 97> VAR. 98>
	3B0 092 155	detachable towing device for serv. install. use: electr.installation kit 13-pin	genuine vw 3B0 055 204 B	1	PASSAT LIM. 97> VAR. 98>
	3B0 092 156	detachable towing device as required use: electr.installation kit 13-pin	genuine vw 3B0 055 204 B	1	PASSAT LIM. 97> VAR. 98>

Model	Year	MG	SG	Illustration	VIN No.	Update	15:46	18.02.20100		ETKA	
ZPA	90	0	25	25-01		336					



Pos	Part Number	Name	Remarks	Qty	Model	Pos	Part Number	Name	Remarks	Qty	Model
	3B0 055 203 B	electrical install kit 7-pin use for: towing device	genuine vw 3B0 092 101 3B0 092 101 A 3B0 092 145 3B0 092 155 3B0 092 156	1	PASSAT LIM. 97> VAR. 98>	-	000 092 165 B	towing device accessories	'ORISMAT'	1	
	3B0 055 204 B	electr.installation kit 13-pin use for: towing device	genuine vw 3B0 035 101 3B0 092 101 A 3B0 092 145 3B0 092 155 3B0 092 156	1	PASSAT LIM. 97> VAR. 98>	-	000 092 165	towing device accessories	'ORISMAT 2000'	1	
	000 055 208	electrical install kit 7-pin to be used for: rigid towing device	genuine vw 321 092 115 B 321 092 116 B	1		-	000 092 205	towing device accessories	GUMMI	1	
-	000 055 208 B	electrical install kit 7-pin		1		Z	092 600	ball protective cap towing device	chromed	1	
-	3A5 055 203	electrical install kit 7-pin		1		Z	092 711	adapter FUER FAHRZEUGE MIT 7-POLIGER STECKDOSE UND ANHAENGER MIT 13-POLIGEM STECKER		1	
-	3A5 055 204	electr.installation kit 13-pin		1		-	000 055 300	adapter cable	13>7 POLE	1	
-	3A9 055 203	electrical install kit 7-pin		1		Z	092 716	wiring harnessadapter FUER VERBINDUNGEN VON 13-POLIGER STECKDOSE AUF 7-POLIGEN STECKER	'13/7' 960 MM	1	
-	3A9 055 204	electr.installation kit 13-pin		1		Z	092 715	wiring harnessadapter FUER VERBINDUNGEN VON 7-POLIGER STECKDOSE AUF 13-POLIGEN STECKER	'7/13' 960 MM	1	
-	357 055 204	electr.installation kit 13-pin		1		-	000 055 300 A	adapter cable	7>13 POLE	1	
-	357 055 204	electr.installation kit 13-pin		1		-	000 055 300 B	adapter DOSE 13 POLIG > STECKER 7 POL.	KURZ VOTEX	1	
-	357 055 203	electrical install kit 7-pin		1		Z	092 712	connector	13 pin black plastic	1	
-	357 092 761	cover cover for bumper		1		-	000 055 310	connector	13 pin	1	
	8/74 2BC	grey black		1		-	000 055 303	socket	7 pin	1	
	8/74 9AX	grey/red		1		-	Z 092 714	socket MIT SCHRAUBANSCHLUESSEN	13 pin with rfl cut-off	1	
-	357 092 762	service part only for:	357 092 155 357 092 155 A	1	PASSAT 4/88> /-VARIANT 6/88>		000 055 304 A	socket	13 pin with rfl cut-off mecanic(ally)	1	
-	357 092 761	cover cover for bumper		1		-	000 092 190	sticker for trailer operation	50 KG silver	1	
	8/74 9AX	grey/red		1		-	000 092 191	sticker for trailer operation	75 KG TRANSPARENT	1	
	8/74 2BC	grey black		1							
-	000 092 165 A	towing device accessories	'ORISMAT'	1							

Model	Year	MG	SG	Illustration	VIN No.	Update	15:46	18.02.20100		ETKA	
ZPA	90	0	25	25-01		336					



Pos	Part Number	Name	Remarks	Qty	Model	Pos	Part Number	Name	Remarks	Qty	Model
-	000 092 193	towing device accessories	75 KG KLEBEFOLIE	1							
-	Z 092 707	surface-mounted connector MIT GUMMISCHUTZKAPPE	7 pin plastic	1							
-	Z 092 708	surface-mounted socket MIT SCHRAUBANSCHLUESSEN	7 pin plastic	1							
-	Z 092 713	coupling adapter KUPPLUNGSDOSE MIT HALTEBUEGEL	7 pin	1							
-	Z 092 713	coupling adapter KUPPLUNGSDOSE MIT HALTEBUEGEL	7 pin	1							
-	Z 092 705	switch of relay for vehicles with rear fog light		1							
-	Z 092 706	adapter	KURZ 13>7 POLE	1							
-	000 055 206	relay relay turn signal	12V 21W	1							

Model	Year	MG	SG	Illustration	VIN No.	Update	15:46	18.02.20100		ETKA	
ZPA	90	0	30	30-02		336					



Pos	Part Number	Name	Remarks	Qty	Model
	Z 071 116	roof bar sets roof bar set for vehicles with roof rails with gs-seal for tested safety conforming to din 75 302 official approval as required use: ski holder luggage rack bicycle holder	FREY MAX. 75 KG black lockable aluminium 1 set = 2 parts	1	PASSAT VARIANT 81>
	Z 071 113	luggage rack use for: system roof rack set	MAX. 75 KG black Z 071 116	1	
	Z 071 122	ski holder use for: system roof rack set	6 PAAR SKI Z 071 116	1	
	Z 071 177	bike holder use for: system roof rack set	lockable M.NUTENSTEINEN Z 071 116	1	
	3B9 071 151	supporting rods for vehicles with roof rails as required use: bicycle holder bike lift surfboard holder ski holder roof box	genuine vw black lockable 1F0 071 128 A 4D0 071 128 B 445 071 127 357 071 129 A 000 071 161 C	1	PASSAT VARIANT 98>

Model ZPA	Year 90	MG 0	SG 30	Illustration 30-02	VIN No.	Update 336	15:46	18.02.20100		ETKA	
--------------	------------	---------	----------	-----------------------	---------	---------------	-------	-------------	---	------	---



Pos	Part Number	Name	Remarks	Qty	Model	Pos	Part Number	Name	Remarks	Qty	Model
		luggage basket	191 071 130 F					ski holder	000 071 129 C		
		ski and luggage box	000 071 300					ski holder	191 071 129 F		
			191 071 170 A					snowboard holder	191 071 131 A		
	867 071 126 B	roof bars	lockable	1	PASSAT			bicycle bracket	193 071 128		
		for vehicles with roof rails	black		VARIANT 81>			bicycle bracket	191 071 128 C		
		as required use:						surfboard holder	445 071 127		
		bicycle holder	191 071 128 C					ski and luggage box	191 071 170 A		
			7M0 071 128 A					roof box	000 071 161 A		
		ski holder	000 071 129 C					luggage basket	191 071 130 E		
			191 071 129 D				3B0 071 126	roof rack system	'L.O.G.O'	1	PASSAT sedan 97>
		surfboard holder	445 071 127					as required use:	1F0 071 128 A		
		luggage basket	191 071 130 E						4D0 071 128 B		
		snowboard holder	191 071 131 A						3B0 071 129		
		roof box	000 071 161 C						445 071 127		
			000 071 300						191 071 130 F		
	000 071 151	roof rack system	lockable	1	squareback				000 071 161 C		
		supporting rods	black		6/88>97		445 071 126 B	roof bar set	lockable	1	PASSAT squareback 11/80>3/88
		for vehicles with roof rails	genuine vw					for vehicles with roof rails	silver		
		t slot section	symmetrical					t slot section			
		as required use:	333 071 156 A					357 071 731	roof bars	1	notchback 88>96
			445 071 127					from the kit:	front		
			191 071 128 C						357 071 126		
			357 071 129 A						replacement pt		
			000 071 161 C								
			000 071 300					357 071 732	roof bars	1	notchback 88>96
								from the kit:	rear		
									357 071 126		
									replacement pt		
	333 071 125	roof bars	econorm	2	squareback		357 071 125 B	roof bars	econorm	1	notchback 88>96
		as required use:	lockable		6/88>			rectangular section	lockable		
		ski holder	191 071 129 E					as required use:	black		
								surfboard holder	445 071 127		
								ski holder	000 071 129 C		
									191 071 129 F		
								snowboard holder	191 071 131 A		
								bicycle bracket	193 071 128		

Model	Year	MG	SG	Illustration	VIN No.	Update	15:46	18.02.20100		ETKA	
ZPA	90	0	30	30-02		336					



Pos	Part Number	Name	Remarks	Qty	Model	Pos	Part Number	Name	Remarks	Qty	Model
		luggage basket	191 071 130 E				8/74 041	black			
		roof box	191 071 170 A			-	333 071 143 A	roof rail	left	1	squareback PASSAT 1/92>
		luggage basket	191 071 130 E				8/74 041	black			
		roof box	000 071 161 A				8/74 041	black			
-	333 071 731	roof bars	front replacement pt 333 071 126 from the kit:	1	PASSAT squareback 6/88>96		8/74 041	black		1	
-	333 071 732	roof bars	rear replacement pt 333 071 126 from the kit:	1	squareback PASSAT 89>	-	333 853 705 B	cover strip for roof for vehicles with roof rail	left 1900MM	1	squareback PASSAT
	8/74 041	black				-	333 853 706 B	cover strip for roof for vehicles with roof rail	right 1900MM	1	squareback PASSAT
-	333 071 144	roof rail FUER FZGE.>FGST.NR. 31NE204999 BZW. 31NB155725	right	1	squareback PASSAT 89>	-	333 071 156	bag	black	1	
	8/74 041	black						supporting rods supporting rods part corresponds to:	only for: 000 071 151 333 071 151041 333 860 027		
	333 071 154	set of screws 1 set of mounting parts for roof rail F >> 31 NE 205 000 F >> 31 NB 155 726		1	PASSAT VARIANT 89>			roof railing set	'M 951'		
-	333 071 155	gasket roof rail sleeve FUER FZGE.>FGST.NR. 31NE204999 BZW. 31NB155725		1	squareback PASSAT 89>		331 071 140	roof rail comprising:	'M 951' 331 071 143 331 071 144	1	squareback 11/80>3/88 squareback SYNCRO >3/88
								securing parts for serv. install. use:	331 071 151 331 071 152	4 2	
-	333 071 140 A	roof rail F 31-NE205 000>> F 31-NB155 726>> comprising: roof rail roof rail attachment screws processing instruction also use:	KOMPLETT	1	PASSAT VARIANT 92>		11/80 3/88 041	black			
							11/80 3/88 666	silver			
							331 071 143	roof rail	left from the kit: 331 071 140 replacement pt	1	
							11/80 3/88 041	black			
							11/80 3/88 666	silver			
							11/80 3/88 041	black			
							11/80 3/88 666	silver			
							331 071 151	carrier bar	replacement pt M 951 only for:	1	squareback
							11/80 3/88 666	silver			

Model	Year	MG	SG	Illustration	VIN No.	Update	15:46	18.02.20100		ETKA	
ZPA	90	0	30	30-02		336					



Pos	Part Number	Name	Remarks	Qty	Model	Pos	Part Number	Name	Remarks	Qty	Model
	11/80 3/88 041	black									
	331 071 152	limiting bar	replacement pt only for: M 951	1							
	11/80 3/88 041	black									
	11/80 3/88 666	silver									

Model	Year	MG	SG	Illustration	VIN No.	Update	15:47	18.02.20100		ETKA	
ZPA	90	0	30	30-03		336					



Pos	Part Number	Name	Remarks	Qty	Model
		special transport equipment			
-	000 071 269	anti-theft lock	only for: 000 071 126 C	1	
-	Z 071 120	locking set for roof bars	FREY only for: Z 071 116	1	squareback PASSAT
	Z 071 113	luggage rack use for: system roof rack set	MAX. 75 KG black Z 071 116	1	
	Z 071 165	roof luggage rack	MAX. 120 KG metal black 155 X 85 CM tuev-tested	1	PASSAT squareback OHNE DACHREILING
	Z 071 294	trolley	125KG aluminium fold-open	1	
	Z 071 177	bike holder use for: system roof rack set	lockable M.NUTENSTEINEN Z 071 116	1	
-	1F0 071 128 A	bicycle bracket for all roof bars with 20x30mm rectangular section	'BIKER' plus part	1	
	Z 071 151	bike holder use for: system roof rack set luggage carrier	metal as required use: Z 071 152	1	
	Z 071 152	lock knob use for: bike holder	Z 071 152	1	
	191 071 128 C	bicycle bracket for all roof bars and supporting rods for 1st bike	black dismountable votex frame, round as required use:	1	
		lock adapter	191 071 267 000 071 271		
-	191 071 267	lock knob lock	only for: 191 071 128 C	1	
-	000 071 271	adapter for bmx / mountain bike	only for: 191 071 128 C	1	

Model	Year	MG	SG	Illustration	VIN No.	Update	15:47	18.02.20100		ETKA	
ZPA	90	0	30	30-03		336					



Pos	Part Number	Name	Remarks	Qty	Model	Pos	Part Number	Name	Remarks	Qty	Model
	193 071 128	bicycle bracket for all roof bars with 20x30mm rectangular section anti-theft lock	VOTEX	1			4D0 071 128 DD	bike lift for all roof bars with t slot section with gs-seal for tested safety conforming to din 75 302 max.weight of bike: unladen weight:	TWIN-PACK plus part votex	2	
	1F0 071 128	bicycle holder for all roof bars with 20x30mm rectangular section for all roof bars with t slot section with gs-seal for tested safety conforming to din 75 302	'BIKER' lockable votex	1		-	191 071 130 E	luggage basket for all roof bars with 20x30mm rectangular section official approval	VOTEX black 1010X700 MM	1	
	7M0 071 128 A	bicycle holder for all roof bars with 20x30mm rectangular section profile c for installing fork with quick tensioner also use: 1 set of securing parts	7M0 071 271	1			191 071 130 F	luggage basket for all roof bars and supporting rods not for:	VOTEX 'econorm' / 'aeronorm' 333 071 125 357 071 125	1	
-	4D0 071 128 B	bike lift for all roof bars with t slot section with gs-seal for tested safety conforming to din 75 302 not for: max.weight of bike: unladen weight:	VOTEX plus part 8D5 071 126 20 KG 6,7 KG	1		Z	071 293	luggage net with securing hooks on both sides	rubber	1	
-	4D0 071 128 C	bike lift for all roof bars with 20x30mm rectangular section with gs-seal for tested safety conforming to din 75 302 max.weight of bike: unladen weight:	VOTEX plus part 20 KG 7,2 KG	1		Z	071 285	luggage tarpaulin and strap	foil	1	
	4D0 071 128 CD	bike lift for all roof bars with 20x30mm rectangular section with gs-seal for tested safety conforming to din 75 302 max.weight of bike: unladen weight:	TWIN-PACK plus part votex 20 KG 7,2 KG	2		Z	071 287	luggage elastic straps strap with securing hooks on both sides	808MM 8-ARMIG	1	
	4D0 071 128 D	bike lift for all roof bars with t slot section with gs-seal for tested safety conforming to din 75 302 max.weight of bike: unladen weight:	VOTEX plus part 20 KG 6,7 KG	1		-	000 071 289 A	lashing strap with tensioning ratchet	5000MM VOTEX	1	
							000 071 289 B	luggage strap with tensioning ratchet dimensions: for maximum:	tuev-tested votex 2,5M 25MM 500KG black polyester	1	
							1H0 071 104 A	rear rack for transporting 2 bikes not in combination with: rear/roof spoiler install time:	tuev-tested votex partially preassembled 30MIN	1	PASSAT squareback 94>
						-	Z 071 122	ski holder only for:	Z 071 110 Z 071 116 Z 071 138 Z 071 139	1	

Model	Year	MG	SG	Illustration	VIN No.	Update	15:47	18.02.20100		ETKA	
ZPA	90	0	30	30-03		336					



Pos	Part Number	Name	Remarks	Qty	Model	Pos	Part Number	Name	Remarks	Qty	Model
-	000 071 129 C	ski carrier ski holder for all roof bars with 20x30mm rectangular section	black 1 set = 2 parts not for: VAKUUM- LANGLAUFSKIER	1			445 071 127	surfboard holder for all roof bars and supporting rods for maximum:	votex 2 BRETTER MIT MASTEN	1	
-	191 071 129 D	ski holder	lockable black 1 set = 2 parts only for: 867 071 126 B 000 071 126 C	1							
	333 071 129	ski carrier use for: supporting rods	333 071 151 (041)	1							
-	357 071 129 A	ski carrier, lockable ski holder	black only for: 'AERONORM' AUCH FUER: VAKUUM- LANGLAUFSKIER only for:	1							
		roof bars	333 071 126 357 071 126								
		roof rack system	000 071 151								
	3B0 071 129	holder ski / snowboard suitable for roof bars/rods with section c slot for all roof bars with 20x30mm rectangular section for maximum:	lockable genuine vw 1 set = 2 parts tuev-tested 2 SNOWBOARDS 4 PAAR SKIER	1							
	3B0 071 129 A	holder ski / snowboard suitable for roof bars/rods with section c slot for all roof bars with 20x30mm rectangular section for maximum:	lockable tuev-tested 4 SNOWBOARDS 6 PAAR SKIER	2							
	191 071 131 A	snowboard holder for all roof bars with 20x30mm rectangular section for maximum: with gs-seal for tested safety conforming to din 75 302	black 1 set = 2 parts 2 SNOWBOARDS votex	1							
-	893 071 290	lifting bracket	1 set = 2 parts	1							

Model	Year	MG	SG	Illustration	VIN No.	Update	15:47	18.02.20100		ETKA	
ZPA	90	0	30	30-04		336					



Pos	Part Number	Name	Remarks	Qty	Model
		luggage boxes			
	Z 071 950	roof box ZUSAETZLICHER TRAEGER WIRD NICHT BENOETIGT	'TOURING' KAMEI lockable silver DUROKAM volume: 320 LITER also use: as required use:	1	PASSAT VARIANT MIT RELING 88>
	Z 071 999	fitting kit use for: roof box	Z 071 999 Z 071 198	1	PASSAT VARIANT MIT RELING 88>
	Z 071 198	lock use for: roof box	Z 071 950	1	
	Z 071 954	roof box . . permis.load carr.capacity: volume: dimensions: material: silver as required use:	'DELPHIN' KAMEI lockable 50 KG 260 L. 230X53X33 CM DUROKAM silver	1	
		ski rack insert	Z 071 952		
		bag	Z 071 957		
	Z 071 957	bag use for: roof box	'KAMEI' shaped to fit Z 071 954	4	
	Z 071 952	ski rack insert use for: roof box	3 PAAR SKI Z 071 954	1	

Model	Year	MG	SG	Illustration	VIN No.	Update	15:47	18.02.20100		ETKA	
ZPA	90	0	30	30-04		336					



Pos	Part Number	Name	Remarks	Qty	Model	Pos	Part Number	Name	Remarks	Qty	Model
	Z 071 955	roof box . . permis.load carr.capacity: volume: dimensions: material:	'DELPHIN' KAMEI lockable 50 KG 375 L. 140X99X42 CM DUOKAM silver	1			000 071 300	sports and luggage container suitable for roof bars/rods with section c slot volume: dimensions: unladen weight:	'DAVOS' genuine vw grey 300 LITER 2345X635X335 29 KG	1	
	Z 071 956	roof box . . permis.load carr.capacity: volume: dimensions: material:	'DELPHIN' KAMEI lockable 50 KG 460 L. 235X74X40 CM DUOKAM silver	1			191 071 170 A	roof box ski and luggage box for all roof bars and supporting rods volume:	000 071 270 VOTEX lockable 250 LITER	1	
		as required use:					- 191 071 737 D	attachment part to be used for:	replacement pt 000 071 170	1	
		ski rack insert	Z 071 952				- 000 071 290	roof box lid lift	VOTEX	1	
		bag	Z 071 957								
	Z 071 980	bag use for: roof box	'KAMEI' shaped to fit Z 071 956	4							
	Z 071 995	ski rack insert use for: roof box	4 PAAR SKI Z 071 956	1							
	Z 071 958	bracket use for: roof box	FUER DIE SICHERE AUF- BEWAHRUNG	1							
	000 071 161 C	roof box rectangular section aeronorm symmetrical section volume: permis.load carr.capacity: unladen weight: dimensions:	'COMPACT' votex tuev-tested 360 LITER 50 KG 13 KG 1395X965X370MM	1							

Model	Year	MG	SG	Illustration	VIN No.	Update	15:48	18.02.20100		ETKA	
ZPA	90	0	35	35-01		336					



Pos	Part Number	Name	Remarks	Qty	Model
		aerodynamic body parts			
	Z 071 814	radiator grille SPORTGRILL TUEV-FREI	'KAMEI' AUS METALL black	1	PASSAT 94>
	Z 071 809	headlamp trim frame TUEV-FREI if necessary paint	'KAMEI' AUS ABS	1	PASSAT 94>
	Z 071 808	bonnet spoiler TUEV-FREI if necessary paint	'KAMEI' AUS ABS	1	PASSAT 94>
	357 071 640	tailgate spoiler official approval complete with fitting instructions and fitting material if necessary paint in color of vehicle	black PUR votex	1	PASSAT 89>93 notchback
	357 071 640 A	tailgate spoiler official approval complete with fitting instructions and fitting material if necessary paint in color of vehicle	black EPDM votex	1	PASSAT 88>93 notchback
	3A2 071 640	tailgate spoiler construction use regulations inscription complete with fitting instructions and fitting material	'HIGH SPORT' votex 000 071 647	1	PASSAT 94> notchback
	000 071 647	inscription use for: tailgate spoiler	'HIGH SPORT' replacement pt 3A2 071 640 votex	1	
-	3A2 071 645	tailgate spoiler with 3rd brake light comprising: additional brake light construction use regulations	VOTEX beige 000 071 645	1	notchback 94>96
	Z 071 840	headlamp trim frame TUEV-FREI material:	'KAMEI' black ABS 1 set = 2 parts	1	PASSAT 97>

Model	Year	MG	SG	Illustration	VIN No.	Update	15:48	18.02.20100		ETKA	
ZPA	90	0	35	35-01		336					



Pos	Part Number	Name	Remarks	Qty	Model	Pos	Part Number	Name	Remarks	Qty	Model
	Z 071 842	radiator grille SPORTGRILL	'KAMEI' tuev-tested material: metal black	1	PASSAT 97>						
	Z 071 851	radiator grille front grille if necessary paint	'ABT' MIT ABT-LOGO TUEV-FREI material: ABS black	1	PASSAT 97>						
	3B0 071 609	front spoiler construction use regulations complete with fitting instructions and fitting material if necessary paint	votex PU-RIM black	1	PASSAT LIM. 97> VAR. 98>						
	3B0 071 645	tailgate spoiler with 3rd brake light construction use regulations additional brake light complete with fitting instructions and fitting material if necessary paint	VOTEX beige not for: 000 071 645	1	PASSAT 97> squareback						
	3B9 071 640	roof spoiler construction use regulations if necessary paint in color of vehicle fitting: bonding	votex	1	PASSAT 98> squareback						
	4/97 9AX	grey/red									
-	3A9 071 640	roof spoiler construction use regulations	'HIGH SPORT' VOTEX beige	1	PASSAT VARIANT 94>						
-	3A9 071 645	roof spoiler with 3rd brake light	VOTEX with: 000 071 645	1	PASSAT VARIANT 88>						
-	000 071 645	retrofitting set for 3rd brake light to be used for:	VOTEX replacement pt 3A2 071 645 3A9 071 645	1							

Model	Year	MG	SG	Illustration	VIN No.	Update	15:48	18.02.20100		ETKA	
ZPA	90	0	35	35-02		336					



Pos	Part Number	Name	Remarks	Qty	Model
		steering wheels			
	Z 064 258	steering wheel (leather) AUSTAUSCH-LEDERLENKRAD for vehicles with airbag construction use regulations exchange/conversion only in authorized workshops!	'VW 10' 4-spokes leather	1	PASSAT/ VARIANT/ diesel eng. 35I SYNCRO/ VARIANT/ GT SYNCRO G60D 35I-299
	5/73 001	blue			
	5/73 002	green green			
	5/73 004	red red			
	5/73 041	black			
	5/73 632	violet			
	Z 064 240	steering wheel (leather) construction use regulations diameter: NUR FUER FZG. MIT FEINVER- ZAHNTER LENKSAEULE UND AUCH FUER FZG. MIT WINKELVERSTELL- LENKSAEULE!	'GRIP-S' 3-spokes 360 MM leather	1	PASSAT/ squareback 35I 35I-299 89>
		also use:	Z 064 243		
	5/73 041	black			
	5/73 045	multicolour			
	Z 064 248	impact protection for steering wheel:	Z 064 240	1	
	5/73 042	code key	SCHWARZ/MINT		
	5/73 043	grey black	SCHWARZ/FUXIA		
	5/73 042	code key	SCHWARZ/MINT		
	5/73 043	grey black	SCHWARZ/FUXIA		
	5/73 044	code key	SCHWARZ/VIOLET		
	Z 064 243	steering wheel adapter for steering wheel:	Z 064 240	1	M 1261

Model	Year	MG	SG	Illustration	VIN No.	Update	15:48	18.02.20100		ETKA	
ZPA	90	0	35	35-02		336					



Pos	Part Number	Name	Remarks	Qty	Model	Pos	Part Number	Name	Remarks	Qty	Model
-	1H0 064 244	part.wood-trimmed steer.wheel for vehicles with airbag	4-spokes 365 MM standard	1	PASSAT 88>	-	893 064 241 A	steering wheel (leather) 3 SPEICHEN FUER FAHRZEUGE OHNE AIRBAG UND MIT FEINVERZAHNTER, WINKELVERSTELLBARER LENKSAEULE also use: 000 064 717 B	'AUDI SPORT' '35I-299'	1	SYNCRO 88> SYNCRO VARIANT 88> SYNCRO G60 88> SYNCRO G60 VARIANT 88>
	1H0 064 242	sports steering wheel (wood) only in combination with: airbag unit for steering wheel with: exchange/conversion only in authorized workshops!	'AIRBAG' 4 SPEICHEN 365 MM ABE votex	1	PASSAT 88>		8/74 041	black			
-	893 064 241 A	steering wheel (leather) 3 SPEICHEN FUER FAHRZEUGE OHNE AIRBAG UND MIT WINKELVERSTELLBARER, NICHT FEINVERZAHNTER steering column also use: 000 064 717	'AUDI SPORT' '35I'	1	PASSAT 88> squareback 88>	-	4A0 064 244	steering wheel (leather) 4 SPEICHEN FUER FAHRZEUGE OHNE AIRBAG UND MIT WINKELVERSTELLBARER, NICHT FEINVERZAHNTER LENKSAEULE also use: 000 064 717	'VOTEX' '35I'	1	PASSAT 88> squareback 88>
	8/74 041	black					8/74 041	black			
-	893 064 241 A	steering wheel (leather) 3 SPEICHEN FUER FAHRZEUGE OHNE AIRBAG UND MIT WINKELVERSTELLBARER, NICHT FEINVERZAHNTER steering column also use: 000 064 717	'AUDI SPORT' '35I-299'	1	SYNCRO 88> SYNCRO VARIANT 88> SYNCRO G60 88> SYNCRO G60 VARIANT 88>	-	4A0 064 244	steering wheel (leather) 4 SPEICHEN FUER FAHRZEUGE OHNE AIRBAG UND MIT WINKELVERSTELLBARER, NICHT FEINVERZAHNTER LENKSAEULE also use: 000 064 717	'VOTEX' '35I-299'	1	SYNCRO 88> SYNCRO VARIANT 88> SYNCRO G60 88> SYNCRO G60 VARIANT 88>
	8/74 041	black					8/74 041	black			
	8/74 041	black					8/74 041	black			
-	893 064 241 A	steering wheel (leather) 3 SPEICHEN FUER FAHRZEUGE OHNE AIRBAG UND MIT FEINVERZAHNTER LENKSAEULE also use: 000 064 707 A	'AUDI SPORT' '35I-299'	1	SYNCRO 88> SYNCRO VARIANT 88> SYNCRO G60 88> SYNCRO G60 VARIANT 88>	-	4A0 064 244	steering wheel (leather) 4 SPEICHEN FUER FAHRZEUGE OHNE AIRBAG UND OHNE WINKELVERSTELLBARE steering column also use: 000 064 717	'VOTEX' '32B'	1	PASSAT squareback
	8/74 041	black					8/74 041	black			
-	893 064 241 A	steering wheel (leather) 3 SPEICHEN FUER FAHRZEUGE OHNE AIRBAG UND MIT FEINVERZAHNTER, WINKELVERSTELLBARER LENKSAEULE also use: 000 064 717 B	'AUDI SPORT' '35I'	1	PASSAT 88> squareback 88>	-	4A0 064 244	steering wheel (leather) 4 SPEICHEN FUER FAHRZEUGE OHNE AIRBAG UND OHNE WINKELVERSTELLBARE steering column also use: 000 064 717	'VOTEX' '32B-299'	1	SYNCRO SYNCRO squareback
	8/74 041	black					8/74 041	black			
	8/74 041	black					8/74 041	black			
-	893 064 241 A	steering wheel (leather) 4 SPEICHEN FUER FAHRZEUGE OHNE AIRBAG UND MIT FEINVERZAHNTER steering column also use: 000 064 707 A	'AUDI SPORT' '35I'	1	PASSAT 88> squareback 88>	-	4A0 064 244	steering wheel (leather) 4 SPEICHEN FUER FAHRZEUGE OHNE AIRBAG UND OHNE WINKELVERSTELLBARE steering column also use: 000 064 717	'VOTEX' '35I'	1	PASSAT 88> squareback 88>
	8/74 041	black					8/74 041	black			

Model	Year	MG	SG	Illustration	VIN No.	Update	15:48	18.02.20100		ETKA	
ZPA	90	0	35	35-02		336					



Pos	Part Number	Name	Remarks	Qty	Model	Pos	Part Number	Name	Remarks	Qty	Model
	8/74 041	black				-	000 064 242	steering wheel (leather) 4 SPEICHEN FUER FAHRZEUGE OHNE AIRBAG MIT FEINVERSTELLBARER LENKSAEULE	'CONCORD' VOTEX '35I-299'	1	SYNCRO 88> SYNCRO VARIANT 88> SYNCRO G60 88> SYNCRO G60 VARIANT 88>
	8/74 041	black									
-	4A0 064 244	steering wheel (leather) 4 SPEICHEN FUER FAHRZEUGE OHNE AIRBAG UND MIT FEINVERZAHNTER steering column	'VOTEX' '35I-299'	1	SYNCRO 88> SYNCRO VARIANT 88> SYNCRO G60 88> SYNCRO G60 VARIANT 88>				also use: 000 064 707 A		
	8/74 041	black				-	191 064 243	steering wheel (leather) 3 SPEICHEN FUER FAHRZEUGE OHNE AIRBAG UND MIT WINKELVERSTELLBARER, NICHT FEINVERZAHNTER LENKSAEULE	'VOTEX' '35I'	1	PASSAT 88> squareback 88>
	8/74 041	black							also use: 000 064 717		
-	4A0 064 244	steering wheel (leather) 4 SPEICHEN FUER FAHRZEUGE OHNE AIRBAG UND MIT FEINVERZAHNTER, WINKELVERSTELLBARER LENKSAEULE	'VOTEX' '35I'	1	PASSAT 88> squareback 88>				also use: 000 064 717 B		
	8/74 041	black				-	191 064 243	steering wheel (leather) 3 SPEICHEN FUER FAHRZEUGE OHNE AIRBAG UND MIT WINKELVERSTELLBARER, NICHT FEINVERZAHNTER LENKSAEULE	'VOTEX' '35I-299'	1	SYNCRO 88> SYNCRO VARIANT 88> SYNCRO G60 88> SYNCRO G60 VARIANT 88>
	8/74 041	black							also use: 000 064 717 B		
-	000 064 242	steering wheel (leather) 4 SPEICHEN FUER FAHRZEUGE OHNE AIRBAG	'CONCORD' VOTEX '32B'	1	PASSAT squareback				also use: 000 064 717		
	8/74 041	black									
	8/74 041	black				-	191 064 243	steering wheel (leather) 3 SPEICHEN FUER FAHRZEUGE OHNE AIRBAG UND MIT FEINVERZAHNTER, WINKELVERSTELLBARER LENKSAEULE	'VOTEX' '35I'	1	PASSAT 88> squareback 88>
	8/74 041	black							also use: 000 064 717 B		
-	000 064 242	steering wheel (leather) 4 SPEICHEN FUER FAHRZEUGE OHNE AIRBAG MIT FEINVERSTELLBARER LENKSAEULE	'CONCORD' VOTEX '35I'	1	PASSAT 88> squareback 88>				also use: 000 064 707 A		
	8/74 041	black									
	8/74 041	black				-	191 064 243	steering wheel (leather) 3 SPEICHEN FUER FAHRZEUGE OHNE AIRBAG UND MIT FEINVERZAHNTER, WINKELVERSTELLBARER LENKSAEULE	'VOTEX' '35I'	1	PASSAT 88> squareback 88>
	8/74 041	black							also use: 000 064 717 B		
	8/74 041	black									
	8/74 041	black				-	191 064 243	steering wheel (leather) 3 SPEICHEN FUER FAHRZEUGE OHNE AIRBAG UND MIT FEINVERZAHNTER, WINKELVERSTELLBARER LENKSAEULE	'VOTEX' '35I'	1	PASSAT 88> squareback 88>
	8/74 041	black							also use: 000 064 717 B		

Model	Year	MG	SG	Illustration	VIN No.	Update	15:48	18.02.20100		ETKA	
ZPA	90	0	35	35-02		336					



Pos	Part Number	Name	Remarks	Qty	Model	Pos	Part Number	Name	Remarks	Qty	Model
-	191 064 243	steering wheel (leather) 3 SPEICHEN FUER FAHRZEUGE OHNE AIRBAG UND MIT FEINVERZAHNTER, WINKELVERSTELLBARER LENKSAEULE also use:	'VOTEX' '35I-299' 000 064 717 B	1	SYNCRO 88> SYNCRO VARIANT 88> SYNCRO G60 88> SYNCRO G60 VARIANT 88>						
	8/74 041	black									
-	Z 063 131	steering wheel cover	'AVUS SUPER'	1							
	8/74 041	black									
-	000 064 717	steering wheel adapter	LANG	1							
-	000 064 707 A	steering wheel adapter	KURZ	1							
-	000 064 707 A	steering wheel adapter	KURZ	1							
-	000 064 717 B	steering wheel adapter	LANG	1							
	000 064 300	returning flange with wiper contact use for: steering wheel adapter steering wheel adapter steering wheel adapter	replacement pt 000 064 708 000 064 708 A 000 064 709	1							

Model	Year	MG	SG	Illustration	VIN No.	Update	15:48	18.02.20100		ETKA	
ZPA	90	0	35	35-03		336					



Pos	Part Number	Name	Remarks	Qty	Model
		gearstick knob			
Z	064 266	gearstick knob WURZELHOLZ	ECHTHOLZ ERGONOM-FORM	1	PASSAT 97> PASSAT VARIANT 97> AUSSER: automatic
Z	064 230	gearstick knob GOLFBALL	black	1	VW MIT M12-GEWINDE
Z	064 261	gearstick knob	leather	1	VW MIT M14-GEWINDE
8/74	001	blue			
8/74	002	mint			
8/74	004	red			
8/74	041	black			
8/74	632	violet			
Z	064 262	gearstick trim (leather) use for: gearstick knob	Z 064 261 in appropriate colour .	1	VW MIT 14 MM- GEWINDE
8/74	001	blue			
8/74	004	red			
8/74	002	mint			
8/74	632	violet			
8/74	041	black			
Z	064 220	gearstick knob WURZELNUSS/ALUMINIUM	ERGONOM-FORM 4 ADAPTER	1	VW MIT 14 MM- GEWINDE
Z	064 154	gearstick knob	MAHAGONIHOLZ not for:	1	automatic
Z	064 235	gearstick knob multicolour	leather GRUEN/BLAU/ROT	1	
Z	064 232	gearstick knob	leather black not for:	1	automatic
Z	064 236	gearstick knob ZEBRANO-LOOK	not for:	1	automatic

Model	Year	MG	SG	Illustration	VIN No.	Update	15:48	18.02.20100		ETKA	
ZPA	90	0	35	35-03		336					



Pos	Part Number	Name	Remarks	Qty	Model	Pos	Part Number	Name	Remarks	Qty	Model
-	000 064 225	gearstick knob FUER FAHRZEUGE MIT M12-GEWINDE	'VOLKSWAGEN- MOTORSPORT' not for:	1	VW MIT M12 PASSAT 90>						
	8/74 041	black									
	8A0 064 225	gearstick knob for manual gearbox	'RACING' VOTEX not for:	1	VW MIT M12 PASSAT >90 automatic						
	1H9 064 225	gearstick knob for manual gearbox	'RACING' VOTEX not for:	1	PASSAT 91>96 automatic						
	8A0 064 226	gearstick knob for manual gearbox	'COMFORT' VOTEX not for:	1	VW MIT M12 PASSAT >90 automatic						
	1H9 064 226	gearstick knob for manual gearbox	'COMFORT' VOTEX not for:	1	PASSAT 91>96 automatic						
	1H0 064 227	gearstick knob	'CARBON' VOTEX	1	PASSAT 91>96						
	8D0 064 227	gearstick knob MIT M12 GEWINDE	'CARBON' VOTEX not for:	1	PASSAT 91>						
	1H6 064 226	gearstick knob (wood) with: trim with shift pattern install time:	burred wood votex 5MIN	1	PASSAT 88>96						
	3B0 064 226	gearstick knob (wood) with: trim with shift pattern install time:	burred wood 5MIN	1	PASSAT 97>						

Model	Year	MG	SG	Illustration	VIN No.	Update	15:49	18.02.20100		ETKA	
ZPA	90	0	35	35-04		336					



Pos	Part Number	Name	Remarks	Qty	Model
		suspension kits			
-	357 071 672	sports suspension kit F >> 31-P-026 435	'35I' FICHTEL&SACHS 30 MM not for:	1	PASSAT notchback >92 VR6
-	333 071 672	sports suspension kit F >> 31-P-026 435	'35I' FICHTEL&SACHS 30 MM not for:	1	PASSAT VARIANT >92 VR6
	3A2 071 672	sports suspension kit front spring rear spring shock absorber, rear axle complete with fitting instruc- tions and fitting material official approval	FICHTEL&SACHS	1 2 2 2	PASSAT
	3A2 071 676	suspension lowering kit official approval comprising: front spring rear spring	30-35MM votex not for:	1 2 2	PASSAT 35I sedan 94>96 VR6 diesel eng.
	3A9 071 676	suspension lowering kit official approval comprising: front spring rear spring	30-35MM votex not for:	1	PASSAT 35I squareback 94>96 VR6 diesel eng.
Z	071 726	suspension lowering kit official approval fitting instructions	'FINTEC' 25 - 35 MM	1	PASSAT 4 cylinder 81>88
Z	071 724	suspension lowering kit official approval fitting instructions	'FINTEC' 25 - 35 MM	1	PASSAT squareback 4 cylinder 81>88 AUSSE: SYNCRO
Z	071 723	suspension lowering kit official approval fitting instructions	'FINTEC' 25 - 35 MM	1	PASSAT squareback 5 cylinder 81>88 AUSSE: SYNCRO

Model	Year	MG	SG	Illustration	VIN No.	Update	15:49	18.02.20100		ETKA	
ZPA	90	0	35	35-04		336					



Pos	Part Number	Name	Remarks	Qty	Model	Pos	Part Number	Name	Remarks	Qty	Model
	Z 071 725	suspension lowering kit official approval fitting instructions	'FINTEC' 25 - 35 MM	1	PASSAT 5 cylinder 81>88						
	Z 071 734	suspension lowering kit official approval fitting instructions	'FINTEC' 25 - 35 MM	1	PASSATLIM. 4 cylinder > FAHRSTELL. 31ZPE026435 88>920 AUSSE: SYNCRO						
	Z 071 735	suspension lowering kit official approval fitting instructions	'FINTEC' 25 - 40 MM	1	PASSAT squareback 4 cylinder > FAHRGESTEL 31ZPE026435 AUSSE: SYNCRO						
-	357 071 676	suspension lowering kit F >> 31-P-026 435	30-40MM '35I' EIBACH not for:	1	PASSAT 16V						
-	357 071 677	suspension lowering kit F >> 31-P-026 435	30MM '35I' EIBACH	1	PASSAT 16V						
-	333 071 676	suspension lowering kit F >> 31P 0264 35 comprising: front spring rear spring	30-40MM EIBACH not for:	1 2 2	PASSAT squareback 88>93 35I 16V						
	333 071 677	suspension lowering kit F >> 31P 0264 3 comprising: front spring rear spring	30 MM EIBACH only for:	1 2 2	PASSAT squareback 88>93 35 I 16V						

Model	Year	MG	SG	Illustration	VIN No.	Update	15:49	18.02.20100		ETKA	
ZPA	90	0	35	35-05		336					



Pos	Part Number	Name	Remarks	Qty	Model
	Z 071 767	exhaust silencer, rear exhaust silencer, rear construction use regulations 24 MONATE GARANTIE material: shape: dimensions:	'ERNST-SPORT' 'RALLYE-SOUND' sol. stainless round (dual pipe) 80 MM	1	PASSAT 88>93 UND DIESEL 1,6-2,0 L. 50-85 KW 68-115 PS
	Z 071 800	exhaust silencer, rear construction use regulations 24 MONATE GARANTIE material: shape: dimensions:	'ERNST-SPORT' 'RALLYE-SOUND' sol. stainless round (dual pipe) 80 MM	1	PASSAT 94> AEK 95>, AFT 96>, AAM 94>, ABS,2E 94>, ADZ 95>, ADY 95, AGG 96>, AAZ 94>, 1Z 94>
	Z 071 836	exhaust silencer, rear construction use regulations material: shape: dimensions:	'ABT' MIT ABT-LOGO sol. stainless POLIERT round (dual pipe) 76 MM	1	PASSAT 97>
	3B0 071 901	exhaust silencer, rear tail pipe with: shape: dimensions: install time:	stainlss steel (dual pipe) ABG round 76MM 20MIN	1	PASSAT 97> VARIANT 98> 3B '1,6L 74KW '1,8L 92KW '1,8L 110KW '1,9L TDI

Model	Year	MG	SG	Illustration	VIN No.	Update	15:52	18.02.20100		ETKA	
ZPA	90	0	50	50-01		336					



Pos	Part Number	Name	Remarks	Qty	Model
	7M0 065 400	electrics cool box thermos box as required use: bracket	light grey 28L 12V/48W 3A0 065 401	1	PASSAT VARIANT 88>
	3A0 065 401	bracket thermos box only for:	for: luggage comp. spare wheel cover 7M0 065 400	1	PASSAT VARIANT 88>

Model	Year	MG	SG	Illustration	VIN No.	Update	15:53	18.02.20100		ETKA	
ZPA	90	0	50	50-05		336					



Pos	Part Number	Name	Remarks	Qty	Model
		sport accessories			
	004 050 501	toboggan made of high-quality low temperature resistant plastic outstanding directional stability and slip properties as required use:	genuine vw ce-tested blow-moulded 3 KG blue as required use: 004 050 530	1	
	004 050 520	toboggan made of high-quality low temperature resistant plastic outstanding directional stability and slip properties as required use:	2-seater blue tuev-tested genuine vw as required use: 004 050 530	1	
	004 050 530	child's seat use for: toboggan	silver genuine vw 004 050 500 004 050 501 004 050 520	1	
		retaining strap	with:		
	1J0 019 000	remote control model car scale: with:	GOLF 4 1:10 assembly	1	
		electric motor controller kit as required use:			
		remote control	000 019 000		
	1J0 019 111	remote control model car scale: with:	GOLF 4 1:14	1	
		electric motor remote control as required use:			
		not for "usa"/"cdn"	000 019 002		
	000 019 000	remote control set to be used for: remote control model car comprising: battery charger rechargeable battery not for "usa"/"cdn"	genuine vw 1J0 019 000 1:10 220V	1	
	000 019 001	rechargeable battery quick-charging with tamiya plug use for: remote control model car	NI-CAD 7,2V 1500MAH 1J0 019 000 1:10	1	

Model	Year	MG	SG	Illustration	VIN No.	Update	15:53	18.02.20100		ETKA	
ZPA	90	0	50	50-05		336					



Pos	Part Number	Name	Remarks	Qty	Model	Pos	Part Number	Name	Remarks	Qty	Model
	000 019 002	charging set comprising: rechargeable battery battery charger use for: remote control model car	genuine vw 9,6V 750 MAH 220V 1J0 019 111 1:14	1			000 099 200 A	lighter	'VOLKSWAGEN MOTORSPORT' black genuine vw	1	
	000 019 500	child's car for children in the age of: as required use: push rod trailer	JUNIOR KAEFER blue tuev-tested genuine vw 1 - 3 years	1							
	000 019 502	child's car for children in the age of: horn towing device official approval as required use: push rod trailer	JUNIOR KAEFER yellow 1 - 3 years genuine vw	1							
	000 019 503	child's car for children in the age of: as required use: push rod trailer	JUNIOR KAEFER red tuev-tested genuine vw 1 - 3 years	1							
	000 019 501	push rod to be used for: child's car	genuine vw 000 019 500 000 019 502 000 019 503	1							
	000 019 505	trailer use for: child's car	genuine vw blue JUNIOR KAEFER 000 019 500 000 019 502 000 019 503	1							
	003 050 112	quartz watch for ladies and gents with: wrist strap: battery	'BIKER' genuine vw leather	1							

Model	Year	MG	SG	Illustration	VIN No.	Update	15:55	18.02.20100		ETKA	
ZPA	90	0	55	55-01		336					



Pos	Part Number	Name	Remarks	Qty	Model
		exchange radios			
-	#1H0 035 152 X	stereo radio with cassette the following are accepted for processing:	'BETA' 1H0 035 152 BLAUPUNKT GRUNDIG	1	
-	#1H0 035 152 AX	stereo radio with cassette the following are accepted for processing:	'BETA' 'PINK FLOYD' 1H0 035 152 A GRUNDIG	1	
	#1J0 035 152 BX	stereo radio with cassette (exchange part) the following are accepted for processing:	'VW BETA' blaupunkt grundig PHILIPS sony	1	GOLF 99> PASSAT 99> TRANSP. 99>
	#1J0 035 152 CX	stereo radio with cassette (exchange part) the following are accepted for processing:	'VW BETA' blaupunkt grundig PHILIPS sony	1	GOLF 99> PASSAT 99> TRANSP. 99>
-	#357 035 152 AX	stereo radio with cassette the following are accepted for processing:	'BETA' 357 035 152 A PHILIPS	1	
-	#357 035 152 BX	stereo radio with cassette the following are accepted for processing:	'BETA' 357 035 152 B GRUNDIG HEA BLAUPUNKT	1	
	#3B0 035 152 X	stereo radio with cassette the following are accepted for processing:	genuine vw 'VW BETA' 3B0 035 152 grundig	1	
	#3B0 035 152 X	stereo radio with cassette the following are accepted for processing:	genuine vw 'VW BETA' 3B0 035 152 grundig	1	
-	#4A0 035 152 X	stereo radio with cassette the following are accepted for processing:	'BETA CC' 4A0 035 152 BLAUPUNKT	1	

Model	Year	MG	SG	Illustration	VIN No.	Update	15:55	18.02.20100		ETKA	
ZPA	90	0	55	55-01		336					



Pos	Part Number	Name	Remarks	Qty	Model	Pos	Part Number	Name	Remarks	Qty	Model
-	#4D0 035 152 X	stereo radio with cassette the following are accepted for processing:	'BETA CC' 4D0 035 152 BLAUPUNKT	1		-	#1H0 035 186 X	stereo radio with cassette the following are accepted for processing:	'GAMMA' 1H0 035 186 PHILIPS	1	
	#1H0 035 153 AX	stereo radio with cassette (exchange part) the following are accepted for processing:	genuine vw 1H0 035 153 A PHILIPS	1		-	#1H0 035 186 AX	stereo radio with cassette the following are accepted for processing:	'GAMMA' 'PINK FLOYD' 1H0 035 186 A PANASONIC	1	
-	#1H0 035 156 X	stereo radio with cassette the following are accepted for processing:	'ALPHA' 1H0 035 156 BLAUPUNKT GRUNDIG PHILIPS	1 (D)			#1H0 035 186 BX	stereo radio with cassette the following are accepted for processing:	VW GAMMA 1H0 035 186 B PHILIPS	1	
-	#1H0 035 156 AX	stereo radio with cassette the following are accepted for processing:	'ALPHA' 1H0 035 156 A BLAUPUNKT PHILIPS	1			#1J0 035 186 BX	stereo radio with cassette with cd changer control (exchange part) the following are accepted for processing:	VW GAMMA 1J0 035 186 B blaupunkt	1	
-	#357 035 156 AX	radio the following are accepted for processing:	'ALPHA' 131 035 156 A HITACHI HEA BLAUPUNKT	1			#1J0 035 186 CX	stereo radio with cassette with cd changer control with removabl operating device (exchange part) the following are accepted for processing:	VW GAMMA red/blue 1J0 035 186 C blaupunkt	1	GOLF 99> PASSAT 99>
-	#357 035 156 BX	stereo radio the following are accepted for processing:	'ALPHA' 357 035 156 B HITACHI HEA	1		-	#357 035 186 X	stereo radio with cassette the following are accepted for processing:	'GAMMA' 57 035 186 BLAUPUNKT GRUNDIG HITACHI	1	
	#3B0 035 156 X	stereo radio with cassette the following are accepted for processing:	genuine vw 3B0 035 156 blaupunkt	1		-	#357 035 186 BX	stereo radio with cassette the following are accepted for processing:	'GAMMA'(M327) 357 035 186 B BLAUPUNKT GRUNDIG HITACHI	1	
-	#4A0 035 156 X	stereo radio the following are accepted for processing:	'ALPHA' 4A0 035 156 HITACHI	1		-	#357 035 186 DX	stereo radio with cassette the following are accepted for processing:	'GAMMA'(M327) 357 035 186 D PHILIPS	1	
-	#893 035 156 AX	radio the following are accepted for processing:	'ALPHA' 893 035 156 A BLAUPUNKT HITACHI HEA	1		-	#357 035 186 GX	stereo radio with cassette the following are accepted for processing:	'GAMMA' 357 035 186 G PHILIPS	1	

Model	Year	MG	SG	Illustration	VIN No.	Update	15:55	18.02.20100		ETKA	
ZPA	90	0	55	55-01		336					



Pos	Part Number	Name	Remarks	Qty	Model	Pos	Part Number	Name	Remarks	Qty	Model
	#3B0 035 186 X	stereo radio with cassette the following are accepted for processing:	genuine vw 3B0 035 186 panasonic PHILIPS	1		-	#4D0 035 192 AX	stereo radio with cassette the following are accepted for processing:	'DELTA CC' 4D0 035 192 A BLAUPUNKT	1	
-	#4A0 035 186 X	stereo radio with cassette the following are accepted for processing:	'GAMMA CC' 4A0 035 186 BLAUPUNKT PANASONIC	1		-	#893 035 192 X	stereo radio with cassette the following are accepted for processing:	'DELTA' 893 035 192 BLAUPUNKT	1	
-	#4D0 035 186 X	stereo radio with cassette the following are accepted for processing:	'GAMMA CC' 4D0 035 186 BLAUPUNKT GRUNDIG	1		-	#893 035 192 AX	stereo radio with cassette the following are accepted for processing:	'DELTA'(M330) 893 035 192 A BLAUPUNKT	1	
-	#893 035 186 X	stereo radio with cassette the following are accepted for processing:	'GAMMA' 893 035 186 BLAUPUNKT	1		-	#893 035 192 BX	stereo radio with cassette the following are accepted for processing:	'DELTA BOSE' (M 487) 893 035 192 B BLAUPUNKT	1	
-	#893 035 186 BX	stereo radio with cassette the following are accepted for processing:	'GAMMA' 893 035 186 B GRUNDIG BLAUPUNKT HITACHI	1		-	#867 035 186 X	stereo radio with cassette the following are accepted for processing:	'GAMMA' 867 035 186 PHILIPS	1	
-	#893 035 186 DX	stereo radio with cassette the following are accepted for processing:	'GAMMA' 893 035 186 D BLAUPUNKT GRUNDIG HITACHI	1	M 327						
-	#357 035 192 X	stereo radio with cassette the following are accepted for processing:	'DELTA' 357 035 192 BLAUPUNKT	1							
-	#357 035 192 AX	stereo radio with cassette the following are accepted for processing:	'DELTA'(M330) 357 035 192 A BLAUPUNKT	1							
-	#4A0 035 192 X	stereo radio with cassette the following are accepted for processing:	'GAMMA CC' 4A0 035 192 BLAUPUNKT	1							
-	#4D0 035 192 X	stereo radio with cassette the following are accepted for processing:	'DELTA CC' 4D0 035 192 BLAUPUNKT	1							

Model	Year	MG	SG	Illustration	VIN No.	Update	15:56	18.02.20100		ETKA	
ZPA	90	0	55	55-02		336					



Pos	Part Number	Name	Remarks	Qty	Model
		exchange cd changers			
	#3B0 035 111 X	cd-changer the following are accepted for processing:	genuine vw 3B0 035 111 panasonic	1	
	#3B0 035 111 AX	cd-changer (exchange part) the following are accepted for processing:	GENUINE VW 3B0 035 111 A PANASONIC	1	
	#1H0 035 111 X	cd-changer the following are accepted for processing:	genuine vw 1H0 035 111 panasonic	1	
-	#4D0 035 111 X	cd-changer the following are accepted for processing: RUECKLIEFERUNG NUR MIT MAGAZIN	4D0 035 111 BLAUPUNKT	1	
-	#7M0 035 110 X	cd-changer the following are accepted for processing:	7M0 035 110 FMS RADIO	1	

Model	Year	MG	SG	Illustration	VIN No.	Update	16:01	18.02.20100		ETKA	
ALLG	90	0	45	45-01		336					



Pos	Part Number	Name	Remarks	Qty	Model
		chrome care, paint cleaner, polish, wax protection			
-	000 096 505 A	chrome and aluminium care	'COEX' 250ML	1	
	8/74 001	blue			
	Z 096 062 A	chrome care	75 ML-TUBE	1	
	8/74 001	light red			
	8/74 002	red			
	8/74 003	bordeaux red			
	8/74 004	dark blue			
	8/74 005	blue			
	8/74 006	light blue			
	8/74 007	light grey			
	8/74 008	grey			
	8/74 009	anthracite			
	8/74 010	black			
	8/74 011	white			
	8/74 012	ivory			
	8/74 013	light green			
	8/74 014	green			
	8/74 015	dark green			
	8/74 016	violet			
	8/74 017	gold			
	8/74 018	yellow			
	8/74 001	light red			
	8/74 002	red			
	8/74 003	bordeaux red			
	8/74 004	dark blue			
	8/74 005	blue			

Model	Year	MG	SG	Illustration	VIN No.	Update	16:01	18.02.20100		ETKA	
ALLG	90	0	45	45-01		336					



Pos	Part Number	Name	Remarks	Qty	Model	Pos	Part Number	Name	Remarks	Qty	Model
	8/74 006	light blue					8/74 041	black			
	8/74 007	light grey					8/74 060	white			
	8/74 008	grey					8/74 171	grey			
	8/74 009	anthracite					8/74 331	blue			
	8/74 010	black					8/74 332	light blue			
	8/74 011	white					8/74 333	red			
	8/74 012	ivory					8/74 339	bordeaux red			
	8/74 013	light green					8/74 470	green			
	8/74 014	green					8/74 775	gold			
	8/74 015	dark green					Z 096 017 A	polishing cream	250ML	1	
	8/74 016	violet					Z 096 234	polish FUER MATTE LACKE	250ML	SONAX	1
	8/74 017	gold					Z 096 211	polish FUER MATTE LACKE	500ML	SONAX	1
	8/74 018	yellow					Z 096 161	polishing pad	200G		1
-	Z 096 040	colorpen IM THEKENDISPLAY	SONAX 12 FARBEN X 4 STUECK	48			Z 096 162	polishing pad	500G		1
-	000 096 503 A	paint cream	250ML	1			Z 096 167	sanding paste	75ML	SONAX	1
	8/74 001	blue					- 000 096 501 A	tar remover	'COEX' 250ML		1
	8/74 001	blue					8/74 001	blue			
-	000 096 418	paint cleaner, washable	250ML	COEX	1		Z 096 053 A	tar remover	SONAX 300 ML-SPRAY		1
	8/74 001	blue					- 000 096 504 A	paint protection hard wax	'COEX' 250ML		1
	Z 096 210	paint cleaner	500 ML	SONAX	1		8/74 001	blue			
-	000 096 502 A	metallic gloss, the self-shining metallic polish	250ML	COEX	1		Z 096 235	wax .	250 ML	SONAX	1
	8/74 001	blue					Z 096 212	wax .	500 ML	SONAX	1
	Z 096 233	polish & wax .	250 ML	SONAX	1		Z 096 236	hard wax .	250 ML	SONAX	1
	Z 096 219	polish & wax .	500 ML	SONAX	1						
-	Z 096 220	polish wax color .	500 ML	SONAX	1						

Model	Year	MG	SG	Illustration	VIN No.	Update	16:01	18.02.20100		ETKA	
ALLG	90	0	45	45-01		336					



Pos	Part Number	Name	Remarks	Qty	Model	Pos	Part Number	Name	Remarks	Qty	Model
	Z 096 221	hard wax	SONAX	1							
		.	500 ML								
	Z 096 232	wax	SONAX	1							
		FUER METALLIC-LACKE	250 ML								
	Z 096 213	wax	SONAX	1							
		FUER METALLIC-LACKE	500 ML								

Model	Year	MG	SG	Illustration	VIN No.	Update	16:03	18.02.20100		ETKA	
ALLG	90	0	45	45-02		336					



Pos	Part Number	Name	Remarks	Qty	Model
		washing, special clean and care products			
	Z 096 048	aerial cleaner	30 GRAMM	1	
	Z 096 209	anti-demist spray	SONAX 250 ML	1	
Z	Z 096 047	car vacuum-cleaner IM KOFFER	12/220V AUS KUNSTSTOFF MIT ZUBEHOER	1	
-	000 096 413 C	convertible plastic soft top cleaner	500ML	1	
	8/74 001	blue			
-	000 096 414	convertible soft top cleaner	500ML	1	
	8/74 001	blue			
-	000 096 415	convertible soft top impregnator	250ML	1	
	8/74 001	blue			
Z	096 174 A	convertible plastic soft top cleaner	SONAX 500 ML	1	
Z	096 175	textile fabric impregnator FUER CABRIO-VERDECKE	SONAX 500 ML	1	
Z	096 328	easy lotion	'SONAX' 500 ML MIT 3 TUECHERN	1	
-	000 096 402 A	cockpit care	250ML	1	
	8/74 001	blue			
Z	096 130	cockpit spray use for: cockpit care interior trim	200ML SONAX	1	
	8/74 001	citrus			
	8/74 002	vanilla			
-	000 096 410 B	wheel cleaner for all types of wheels	500ML	1	
	8/74 001	blue			

Model	Year	MG	SG	Illustration	VIN No.	Update	16:03	18.02.20100		ETKA	
ALLG	90	0	45	45-02		336					



Pos	Part Number	Name	Remarks	Qty	Model	Pos	Part Number	Name	Remarks	Qty	Model
-	000 096 410 C	wheel cleaner for all types of wheels NACHFUELLFLASCHE	500ML	1			8/74 001	blue			
	8/74 001	blue					Z 096 214	plastic cleaner	500 ML SONAX	1	
	Z 096 011 A	wheel cleaner	500 ML SONAX	1			8/70 041	black			
	Z 096 321	wheel cleaner	1 LITER SONAX	1		-	000 096 400 A	leather care	250ML SONAX	1	
	Z 096 192	wheel cleaner foam spray	600 ML	1			8/74 001	blue			
	Z 096 239	stain remover cloth	'SONAX'	6			Z 096 036	leather care	150 ML SONAX	1	
	Z 096 029	stain remover	300 ML SONAX	1		-	000 096 411 A	engine cleaner	250ML	1	
-	000 096 404 A	glass cleaner for interior and exterior	500ML	1			8/74 001	blue			
	8/74 001	blue					Z 096 170 A	engine cleaner	400 ML SONAX	1	
-	000 096 506 A	rubber care	250ML	1			Z 096 322	care oil	50 ML SONAX	1	
	8/74 001	blue					Z 096 329	care oil	200 ML BALLISTOL	1	
-	000 096 507	rubber care pencil	75ML	1		-	000 096 401 A	upholstery and textile cleaner foam	300ML	1	
	8/74 001	blue					8/74 001	blue			
	Z 096 027 A	rubber care	300 ML SONAX	1			Z 096 076	upholstery foam cleaner	400ML SONAX	1	
	Z 096 028	rubber care product	100 ML MIT SCHWAMM SONAX	1		-	000 096 416	windscreen cleaner concentrate	250ML 1:100	1	
	Z 096 060	rubber care pencil	50 GRAMM SONAX	1			8/74 001	blue			
-	000 096 408 A	insect remover	500ML	1			Z 096 194	screen clear view use for: windscreen washer unit	25ML SONAX	1	
	8/74 001	blue					Z 096 215	screen clear view use for: windscreen washer unit	250ML SONAX	1	
	Z 096 173	insect remover	500 ML SONAX	1			Z 096 095	screen clear view use for: windscreen washer unit	250ML SONAX CITRUSDUFT	1	
-	000 096 403 A	plastic cleaner	250ML	1			Z 096 096	screen clear view use for: windscreen washer unit	1000ML SONAX CITRUSDUFT	1	
	8/74 001	blue									
-	000 096 419	plastic deep care	250ML	1							

Model	Year	MG	SG	Illustration	VIN No.	Update	16:03	18.02.20100		ETKA	
ALLG	90	0	45	45-02		336					



Pos	Part Number	Name	Remarks	Qty	Model	Pos	Part Number	Name	Remarks	Qty	Model
	Z 096 097	screen clear	500ML SONAX	1							
	Z 096 100 A	windscreen cleaner spray	300ML SONAX	1							
-	000 096 417	pearl shampoo (run-off effect)	500ML	1							
	8/74 001	blue									
	Z 096 216	shampoo	1000ML SONAX	1							
	Z 096 041	smoke-ex GEGEN UNANGENEHME GERUECHE	100ML SONAX	1							
	Z 096 032	smoke-ex GEGEN UNANGENEHME GERUECHE	250ML SONAX	1							
-	000 096 409 A	bumper black	200ML	1							
	8/74 001	blue									
	Z 096 237	tar care MIT FRUEHLINGSDUFT	250ML SONAX glossy	1							
	Z 096 238	tar care MIT FRUEHLINGSDUFT	250ML SONAX SEIDENMATT	1							
-	000 096 406 A	washing wax	500ML	1							
	8/74 001	blue									
	Z 096 126 A	washing wax	500ML SONAX	1							
	Z 096 168	wax remover	150ML SONAX	1							

Model	Year	MG	SG	Illustration	VIN No.	Update	16:03	18.02.20100		ETKA	
ALLG	90	0	45	45-03		336					



Pos	Part Number	Name	Remarks	Qty	Model
		washing/cleaning products			
	000 096 166	kit car wash comprising: washing sponge insect sponge washing sponge demisting cloth	genuine vw 4-part plain universal	1 1 1 1 1	
	8/74 001	blue			
	000 096 165 B	anti-demist cloth	votex	1	
	000 096 083	washing sponge insect sponge	110X70X40	1	
	000 096 161	polishing pad	votex	1	
	000 096 152	window cleaning cloth	150MM VOTEX	1	
		washing sponge rubber molding	with:		
	000 096 155	chamois leather	370X540 VOTEX	1	
	000 096 151	washing sponge	170X110X55 VOTEX	1	
	Z 096 202	hand-held spray can	'AUTOBOY' 500 ML	1	
	Z 096 030	surface washer as required use:	BREITE 30 CM Z 096 031	1	
	Z 096 031	aluminium extension telescopic tube	90 - 150 CM for: Z 096 030	1	
	Z 096 152	windscreen cleaner	150 MM- SCHWAMMGUMMI	1	
	Z 096 154	windscreen cleaner	210 MM- SCHWAMMGUMMI	1	
	Z 096 037	windscreen cleaner MIT VERLAENGERUNG	210 MM- SCHWAMMGUMMI	1	
	Z 096 039	washing sponge insect remover	AUS HARTSCHAUM	1	
	Z 096 042	washing sponge insect remover	MIT 2 SEITEN: SCHAUM U.LEDER	1	
	Z 096 150	washing sponge	HALBRUND 21X0,8X0,6 CM NATUR-VISKOSE	1	

Model	Year	MG	SG	Illustration	VIN No.	Update	16:03	18.02.20100		ETKA	
ALLG	90	0	45	45-03		336					



Pos	Part Number	Name	Remarks	Qty	Model	Pos	Part Number	Name	Remarks	Qty	Model
	Z 096 151	washing sponge	angular 17X11X0,6 CM POLYAETHER	1							
	Z 096 132	washing sponge	'DUO' 11,5X7,5X4 CM	1							
	Z 096 158	cleaning fleece use for: washer		10							
	Z 096 163	cloth 'MAGIC-WATERCLEAN'	STARK WASSER- AUFSAUGEND	1							
	Z 096 190	dust mop as required use:	Z 096 191	1							
	Z 096 191	dust mop impregnator use for:	50 CCM Z 096 190	1							
	Z 096 157	washing brush as required use:	1/2"-ANSCHLUß Z 096 113	1							
	Z 096 113	shampoo sticks use for:	Z 096 157	1							
	Z 096 046	cloth	54 X 44 CM VLIESSTOFF	1							
	Z 096 160	washing glove	AUS NYLON	1							
	Z 096 155	chamois leather	44 X 46 CM	1							
	Z 096 155	chamois leather	44 X 46 CM	1							
	Z 096 156	chamois leather	70 X 55 CM	1							
	Z 096 131	washing set comprising: chamois leather washing glove insect sponge insect sponge	55 X 38 CM 23X15X0,3 CM 12X0,8X0,4 CM 15X10X0,55 CM	1							

Model	Year	MG	SG	Illustration	VIN No.	Update	16:03	18.02.20100		ETKA	
ALLG	90	0	45	45-04		336					



Pos	Part Number	Name	Remarks	Qty	Model
		corrosion protection			
	Z 096 184 A	wheel paint use for: wheel disc 'steel'	400 ML SONAX	1	
	Z 096 119	cavity spray	500 ML TEROSON	1	
	Z 096 051 A	corrosion protection	300 ML SONAX	1	
	Z 096 240	corrosion protection grease	300 ML	1	
-	000 096 412 A	engine preserver	250ML	1	
	8/74 001	blue			
	Z 096 241	engine cleaner	500 ML 'SONAX'	1	
	Z 096 242	engine cleaner NACHFUELLFLASCHE	1000 ML 'SONAX'	1	
	Z 096 185 A	engine plast VERSIEGELUNG FÜR MOTOR	300 ML SONAX	1	
-	000 096 600 A	mos2 oil, rust penetrator contact spray	'MOS2 OIL' 250ML	1	
	8/74 001	blue			
	Z 096 325	rust penetrator	300 ML SONAX	1	
-	Z 096 091 A	rust penetrator	'MOS2 OIL' 50ML	1	
	Z 096 090 A	rust penetrator	300 ML SONAX	1	
	Z 096 118	rust penetrator	300 ML TEROSON	1	
	Z 096 012	rust converter/primer	125 ML SONAX	1	
	Z 096 115	stone guard	500 ML TEROSON light grey	1	
	Z 096 120	stone guard	500 ML TEROSON black	1	

Model	Year	MG	SG	Illustration	VIN No.	Update	16:03	18.02.20100		ETKA	
ALLG	90	0	45	45-04		336					



Pos	Part Number	Name	Remarks	Qty	Model	Pos	Part Number	Name	Remarks	Qty	Model
	Z 096 117	underbody sealant spray	TEROSON 500 ML black	1							
	Z 096 088	zinc spray	400 ML	1							

Model	Year	MG	SG	Illustration	VIN No.	Update	16:04	18.02.20100		ETKA	
ALLG	90	0	45	45-06		336					

Pos	Part Number	Name	Remarks	Qty	Model
		winter care products, winter articles			
-	000 096 702 F	antifreeze concentrate	500ML	1	
	8/74 001	blue			
-	000 096 702 G	antifreeze concentrate	1000ML	1	
	8/74 001	blue			
-	000 096 702 H	antifreeze concentrate	25L	1	
	8/70 001	blue		1	
-	000 096 704 C	antifreeze concentrate	60 LTR. metal barrel	1	
	8/70 001	blue			
-	000 096 704 B	antifreeze concentrate	200 litres metal barrel	1	
	8/70 001	blue			
	000 096 704 D	antifreeze concentrate use for: windscreen washer unit	60ltr. >50 degr.cels. .genuine vw	1	
	8/70 001	blue			
	000 096 704 E	antifreeze concentrate use for: windscreen washer unit	200ltr. >50 degr.cels. .genuine vw	1	
	8/70 001	blue			
Z	096 099	antifreeze concentrate use for: windscreen washer unit	MIT CITRUSDUFT 250 ML	1	
Z	096 102	antifreeze concentrate use for: windscreen washer unit	MIT CITRUSDUFT 500 ML	1	
Z	096 103	antifreeze concentrate use for: windscreen washer unit	MIT CITRUSDUFT 1000 ML	1	
Z	096 111	antifreeze concentrate use for: windscreen washer unit	MIT CITRUSDUFT 5000 ML	1	
-	000 096 701 C	deicer	250ML	1	

Model	Year	MG	SG	Illustration	VIN No.	Update	16:04	18.02.20100		ETKA	
ALLG	90	0	45	45-06		336					

Pos	Part Number	Name	Remarks	Qty	Model	Pos	Part Number	Name	Remarks	Qty	Model
	8/74 001	blue					Z 096 305	longlife radiator antifreeze	'G 011' 60 LITER ZWEIWEG-FASS	1	
	Z 096 108	deicer FUER AUTOSCHEIBEN	500 ML	1			Z 096 331	longlife radiator antifreeze	'G 012' 60 LITER ZWEIWEG-FASS	1	
	Z 096 109	deicer FUER AUTOSCHEIBEN	300 ML	1			Z 096 306	longlife radiator antifreeze	'G 011' 205 LITER ZWEIWEG-FASS	1	
	Z 096 093	cold starting aid	250 ML	1			Z 096 332	longlife radiator antifreeze	'G 012' 205 LITER ZWEIWEG-FASS	1	
-	000 096 703	lock-free, anti-corrosion and anti-freeze grease for all seasons	50ML	1			- Z 091 221	ice scraper	'TRAPEZ'	1	
	8/74 001	blue					- Z 091 222	ice scraper MIT STIEL UND GUMMIWISCHER		1	
	Z 096 217	door lock deicer	50 ML	1			Z 096 231	ice scraper IM VERKAUFSDISPLAY	'KRISTALL' BREITE 75 MM	60	
	Z 096 218	winter care products comprising: door lock deicer antifreeze concentrate deicer	50 ML 250 ML 300 ML	1			Z 096 231	ice scraper IM VERKAUFSDISPLAY	'KRISTALL' BREITE 75 MM	60	
	000 096 109 E	longlife radiator antifreeze (for export only) contents of package: minimum quantity:	1.5ltr. 1 carton = 12 cans 12 cartons	1			Z 091 227	ice scraper MIT BRONZESCHABER	BREITE 14 CM	1	
	000 096 109 E	longlife radiator antifreeze (for export only) contents of package: minimum quantity:	1.5ltr. 1 carton = 12 cans 12 cartons	1			Z 091 230	ice scraper MIT HANDSCHUH		1	
	000 096 109 G	longlife radiator antifreeze (for export only)	55l dispos. barrel votex	1			Z 096 110	demisting cloth FUER AUTOSCHEIBEN		1	
	000 096 109 H	longlife radiator antifreeze (for export only)	205L dispos. barrel votex	1			Z 096 038	anti-icing cloth FUER AUTOSCHEIBEN	30 X 24 CM	1	
	Z 096 304	longlife radiator antifreeze	'G 011' 1,5 LITER EINWEG-DOSE	1			Z 091 229	snow brush MIT SCHNEESCHIEBER UND KRATZER	'KOMPAKT' BREITE 25 CM	1	
	Z 096 330	longlife radiator antifreeze	'G 012' 1,5 LITER EINWEG-DOSE	1			Z 091 232	snow brush MIT EISKRATZER	'WINTER STAR'	1	
							Z 093 128	protective plate windshield glass (laminated)	200 X 60 CM	1	

Model	Year	MG	SG	Illustration	VIN No.	Update	16:05	18.02.20100		ETKA	
ALLG	90	0	50	50-03		336					

Pos	Part Number	Name	Remarks	Qty	Model
		installation parts			
-	Z 010 470 TE	exhaust installation paste	60 GR.	1	
-	Z 010 469 TE	exhaust repair paste	200 GR.	1	
-	Z 010 476 TE	exhaust installation adhesive UND DICHTUNG	170 GR.	1	
-	Z 010 359 TE	instant adhesive	2 GR.	1	
-	Z 010 423 TE	plastic dye	'PLAST PT' 75 ML	1	
	8/74 041	black			
	Z 010 440 TE	repair kit comprising: ZWEIKOMPONENTEN-POLYESTER-EL HAERTER STREIFEN-GLASSEIDENGEWEBBAND RUEHRBECHER RUEHRSTAB	245 GR. 5 GR. 125 X 10 CM	1	
-	Z 010 450 TE	glass fibre mat	1 QM	1	
	Z 010 432 TE	aluminium spatula	250 GR. TECHNO	1	
	Z 010 410 TE	fibre spatula	200 GR. TECHNO	1	
	Z 010 411 TE	fibre spatula	500 GR. TECHNO	1	
-	Z 010 420 TE	techno-plast	250 GR.	1	
-	Z 010 421 TE	techno-plast	500 GR.	1	
-	Z 010 422 TE	techno-plast	1000 GR.	1	
-	Z 010 360 TE	universal oil		1	
-	000 099 164	car identification system		1	